



US00D885782S

(12) **United States Design Patent**  
**Gam et al.**

(10) **Patent No.:** **US D885,782 S**

(45) **Date of Patent:** **\*\* Jun. 2, 2020**

- (54) **SOFA**
- (71) Applicant: **Nine United Denmark A/S**, Horsens (DK)
- (72) Inventors: **Stine Gam**, København Ø (DK);  
**Enrico Fratesi**, København Ø (DK)
- (73) Assignee: **HAY A/S**, Horsens (DK)
- (\*\*) Term: **15 Years**
- (21) Appl. No.: **29/658,734**
- (22) Filed: **Aug. 2, 2018**
- (51) **LOC (12) Cl.** ..... **06-01**
- (52) **U.S. Cl.**  
USPC ..... **D6/381**
- (58) **Field of Classification Search**  
USPC ..... D6/334, 335, 374, 375, 381, 336  
CPC ..... A47C 17/00; A47C 17/02; A47C 17/86;  
A47C 13/005; A47C 7/38; A47B 83/00;  
A47B 83/02; A47B 83/023; A47B 83/04;  
A47B 39/08  
See application file for complete search history.

- D807,655 S \* 1/2018 Webb ..... D6/335
- D809,316 S \* 2/2018 Rockwell ..... D6/381
- D840,700 S \* 2/2019 Gyllang ..... D6/335
- D854,851 S \* 7/2019 Smrstick ..... D6/381
- D855,344 S \* 8/2019 Ho ..... D6/369
- D868,487 S \* 12/2019 Vaughan ..... D6/334

(Continued)

*Primary Examiner* — Cathron C Brooks

(74) *Attorney, Agent, or Firm* — Cantor Colburn LLP

(57) **CLAIM**

We claim, the ornamental design for a sofa, as shown and described.

**DESCRIPTION**

FIG. 1 is a perspective view of a sofa, showing our new design;  
 FIG. 2 is a side view thereof, the opposite side view being a mirror image thereof;  
 FIG. 3 is a front view thereof;  
 FIG. 4 is a rear view thereof;  
 FIG. 5 is a top view thereof;  
 FIG. 6 is a bottom view thereof;  
 FIG. 7 is a perspective view thereof in another embodiment;  
 FIG. 8 is a side view thereof, the opposite side view being a mirror image thereof;  
 FIG. 9 is a front view thereof;  
 FIG. 10 is a rear view thereof;  
 FIG. 11 is a top view thereof;  
 FIG. 12 is a bottom view thereof;  
 FIG. 13 is a perspective view thereof in another embodiment;  
 FIG. 14 is a side view thereof, the opposite side view being a mirror image thereof;  
 FIG. 15 is a front view thereof;  
 FIG. 16 is a rear view thereof;  
 FIG. 17 is a top view thereof; and,  
 FIG. 18 is a bottom view thereof.

(56) **References Cited**

**U.S. PATENT DOCUMENTS**

- D262,166 S \* 12/1981 Aronowitz ..... D6/378
- D448,946 S \* 10/2001 Goetz ..... D6/381
- D454,441 S \* 3/2002 Bermudez ..... D6/335
- D560,919 S \* 2/2008 Simons, Jr. .... D6/381
- D679,518 S \* 4/2013 Lievore ..... D6/381
- 8,534,752 B2 \* 9/2013 Martin ..... A47B 13/08  
297/184.15
- D709,712 S \* 7/2014 Jehs ..... D6/381
- D747,892 S \* 1/2016 Bernett ..... D6/363
- D758,777 S \* 6/2016 McKenna ..... D6/717
- D786,571 S \* 5/2017 Webb ..... D6/337
- D794,973 S \* 8/2017 Webb ..... D6/381
- D795,604 S \* 8/2017 Webb ..... D6/381
- D805,310 S \* 12/2017 Grcic ..... D6/335

**1 Claim, 18 Drawing Sheets**

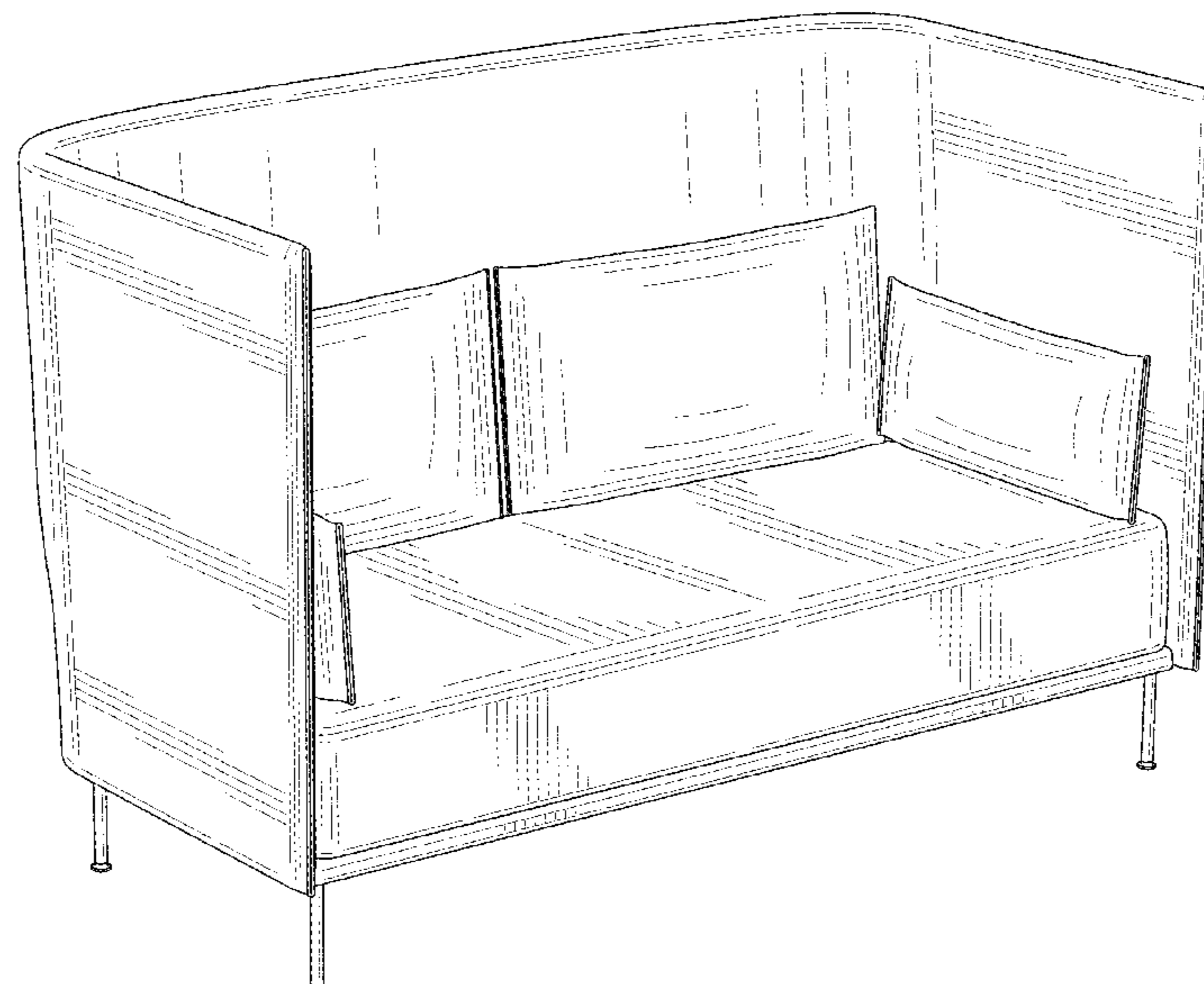

(56)

**References Cited**

U.S. PATENT DOCUMENTS

D869,178 S \* 12/2019 Vaughan ..... D6/335  
2005/0140184 A1\* 6/2005 Williams ..... A47B 83/00  
297/135  
2016/0245005 A1\* 8/2016 Tsuchiyama ..... E04B 2/7409

\* cited by examiner

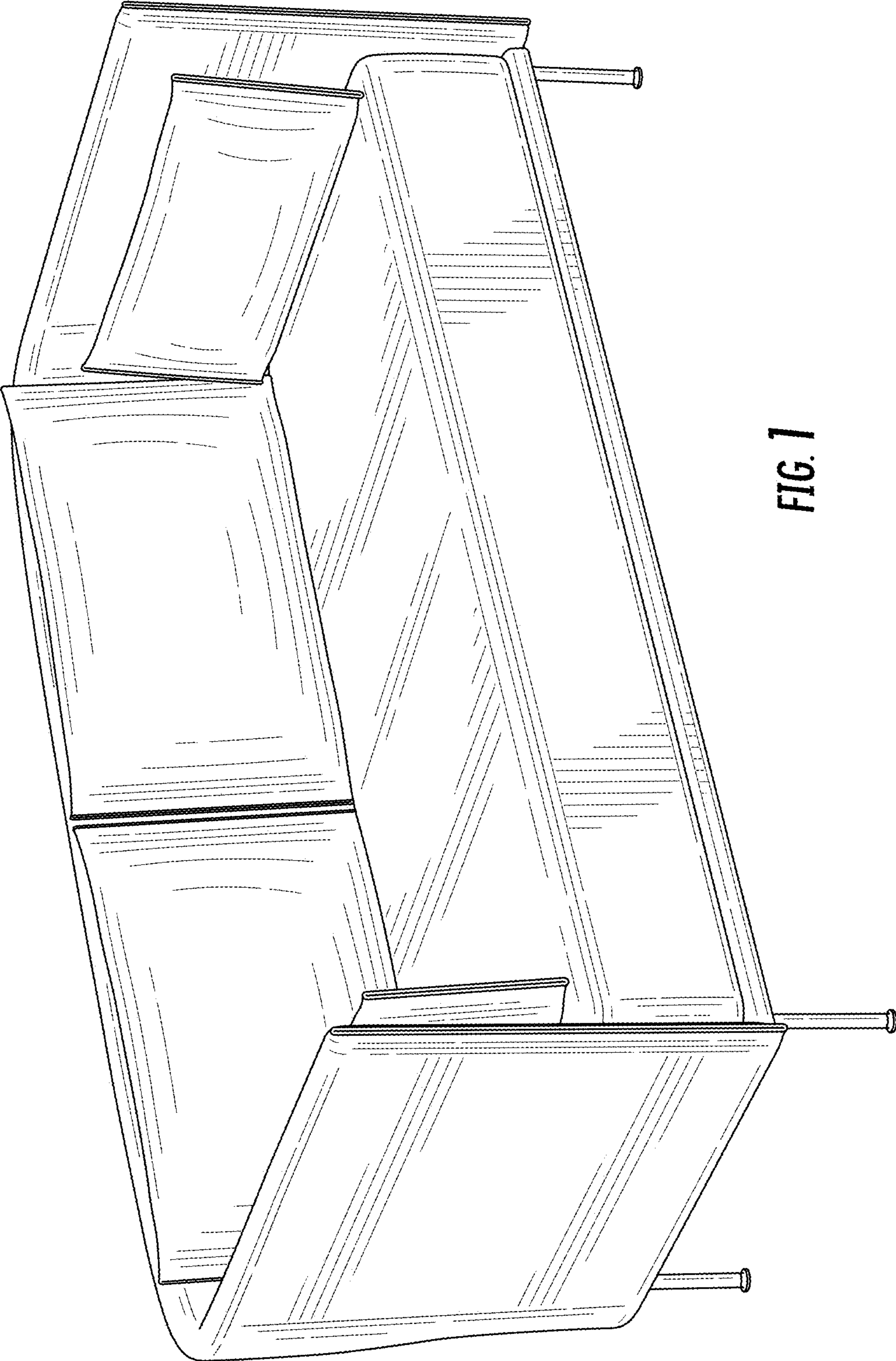
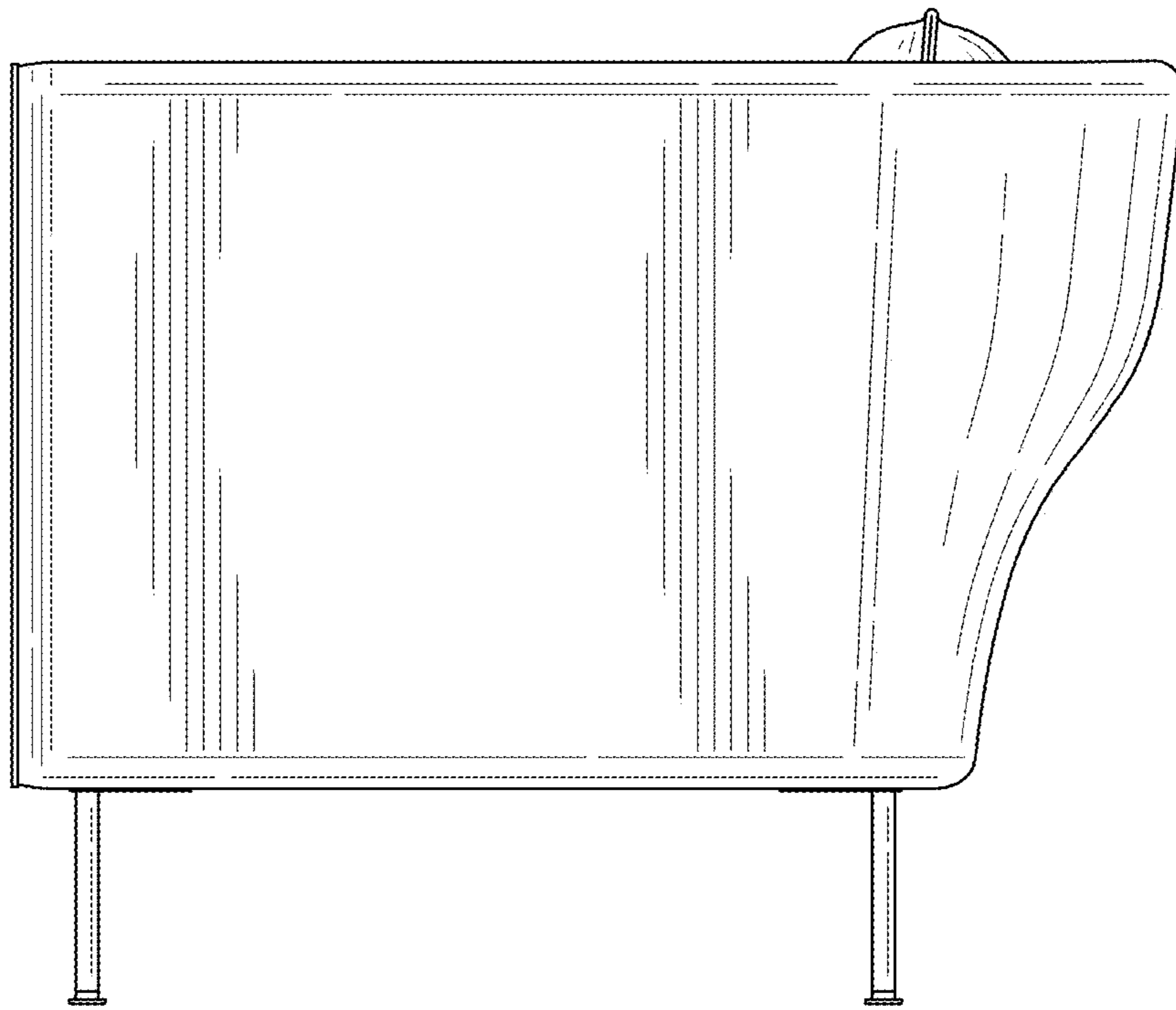

FIG. 1



**FIG. 2**

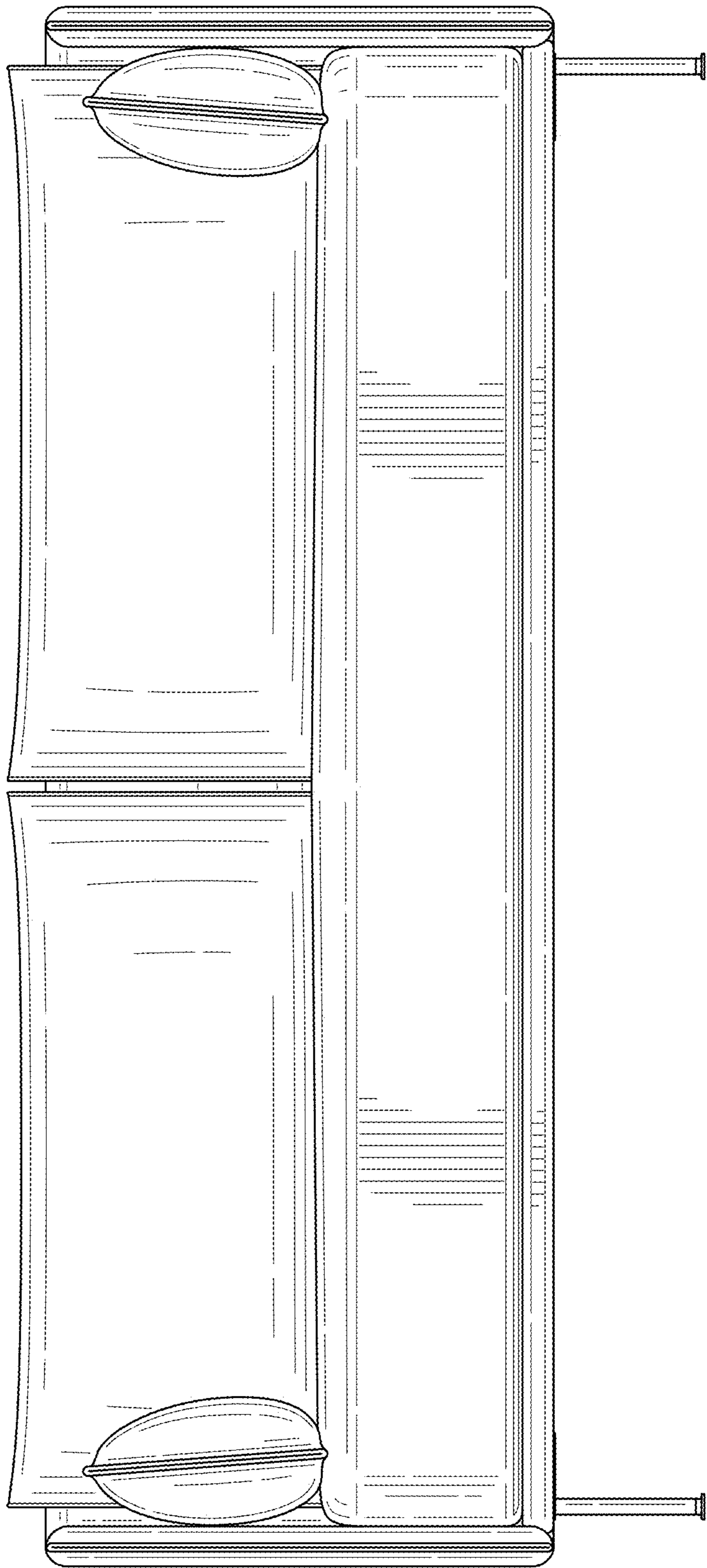

FIG. 3

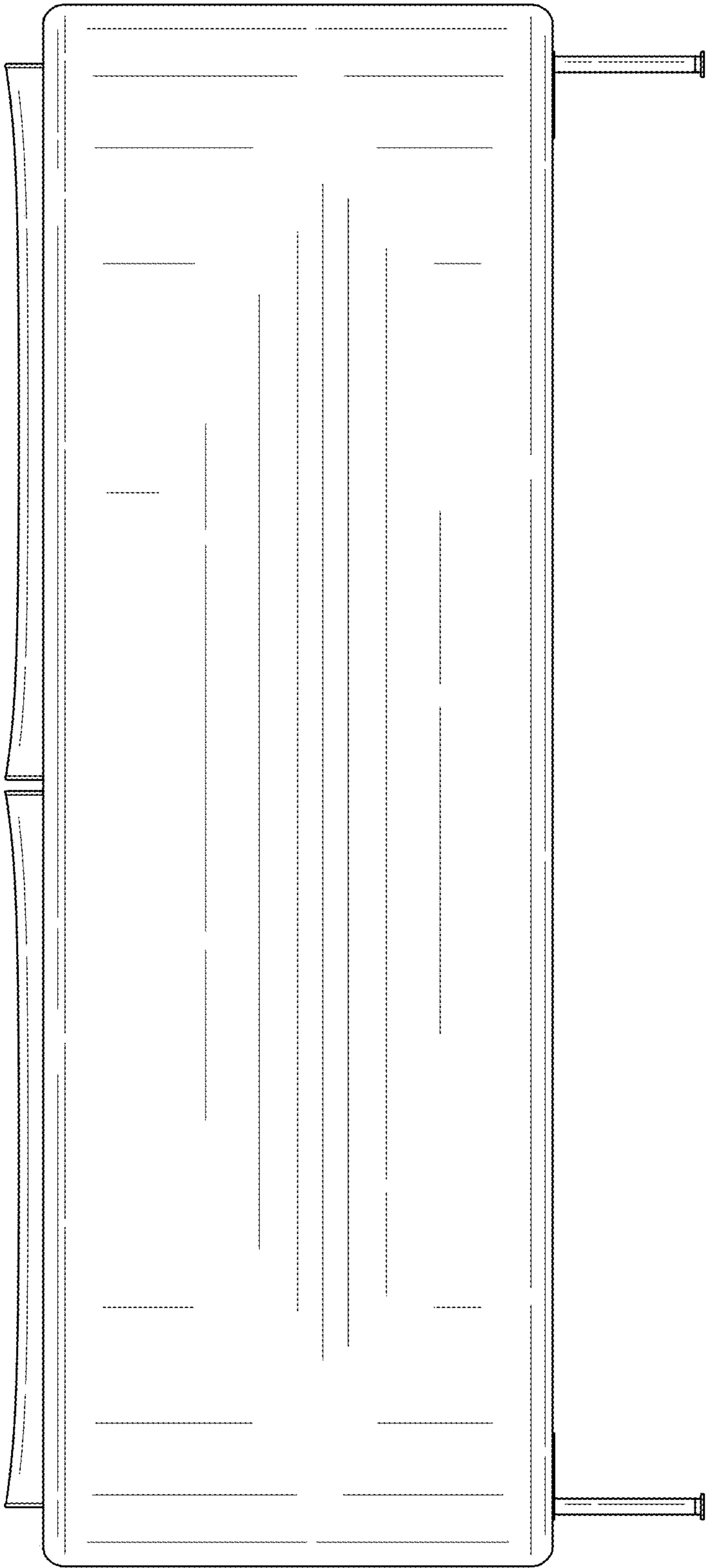

FIG. 4

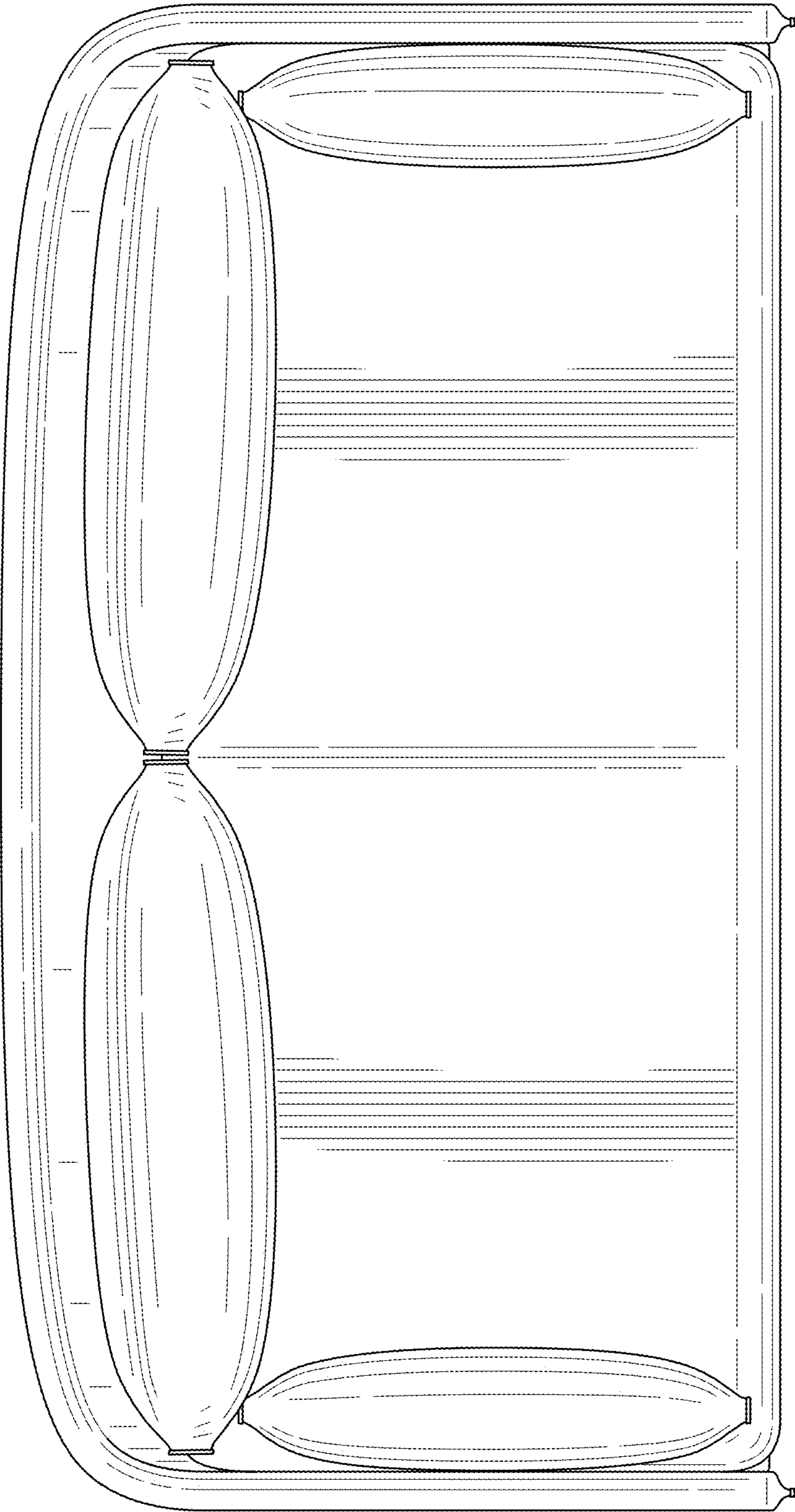

FIG. 5

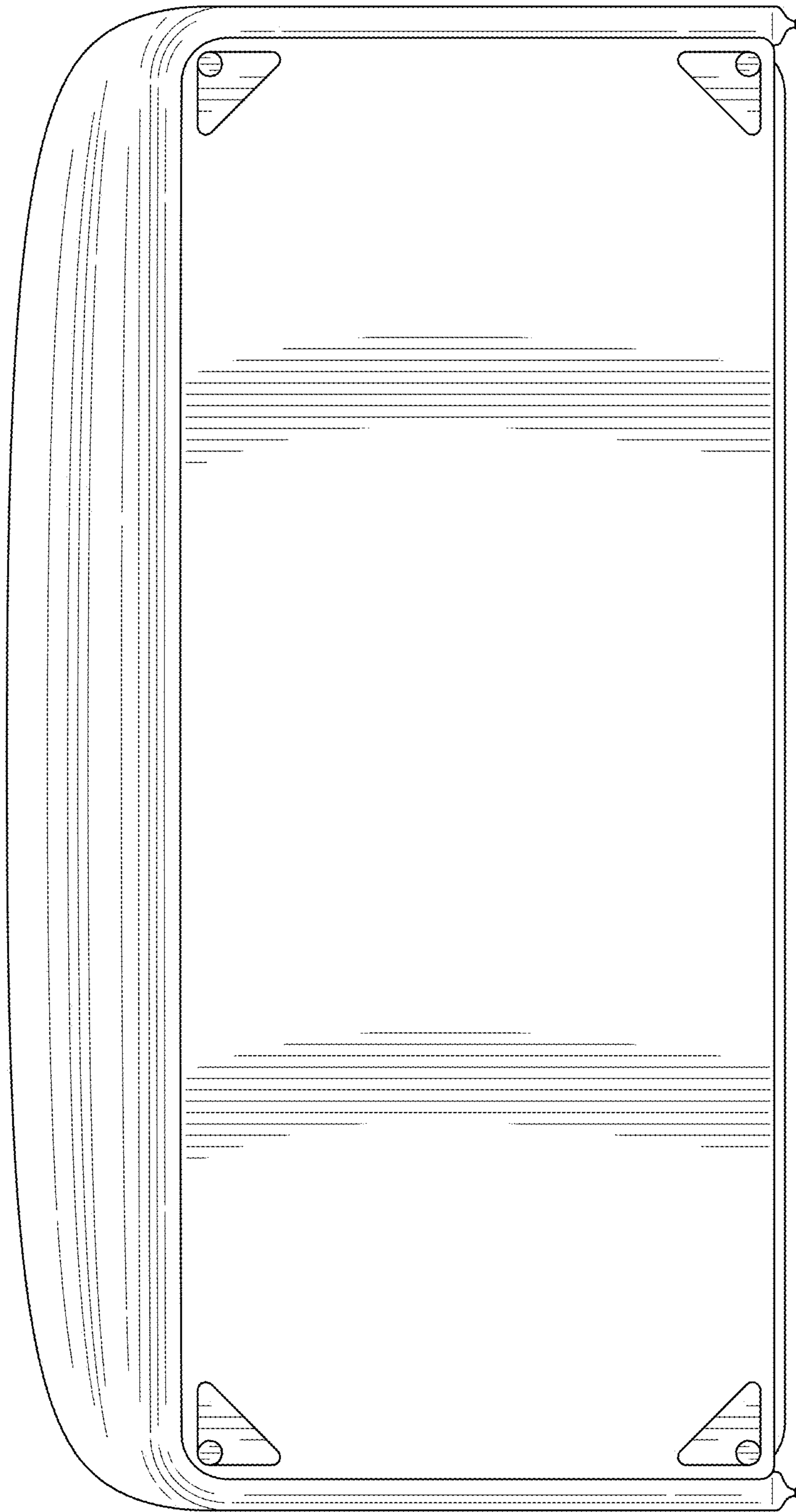

FIG. 6



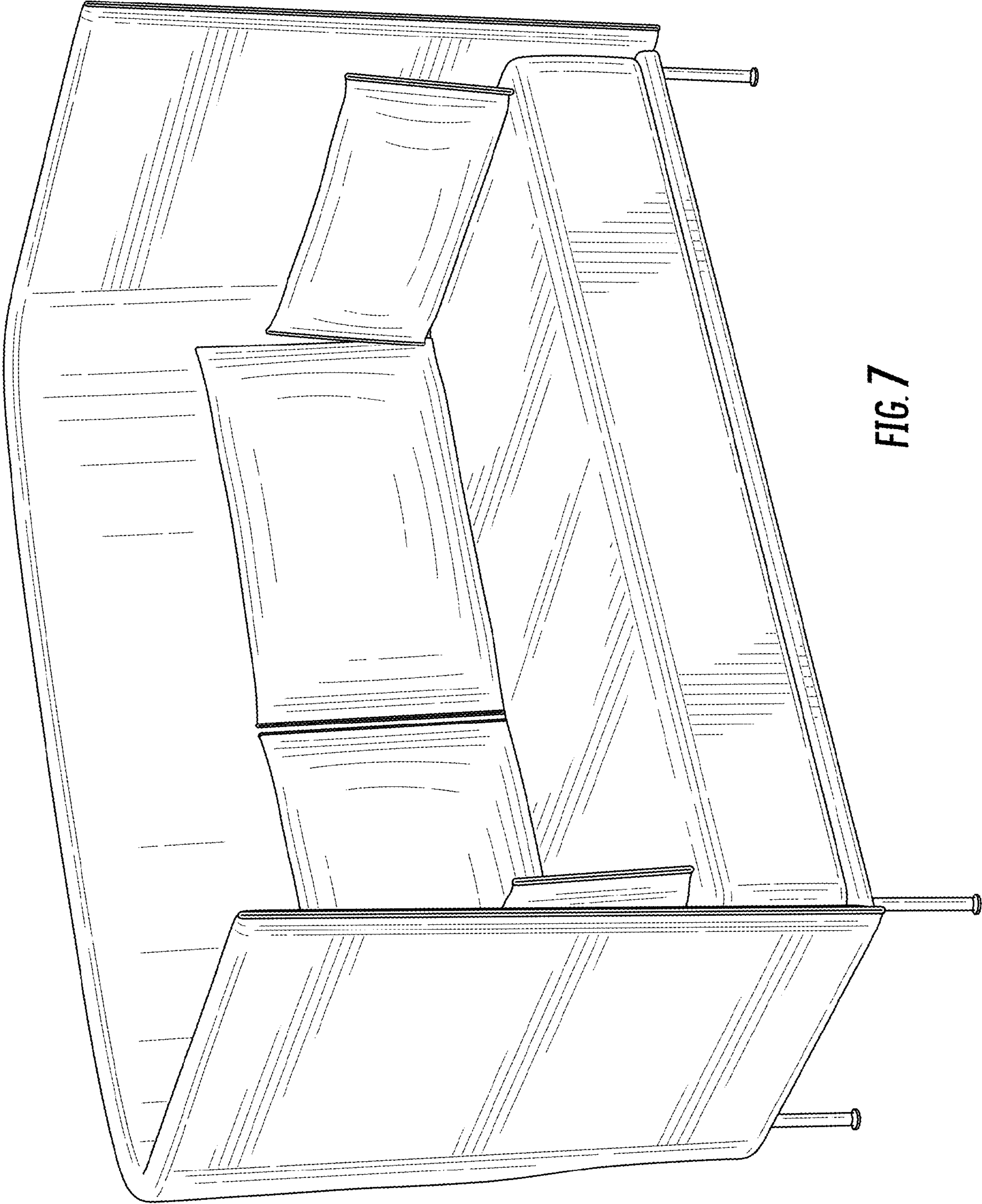
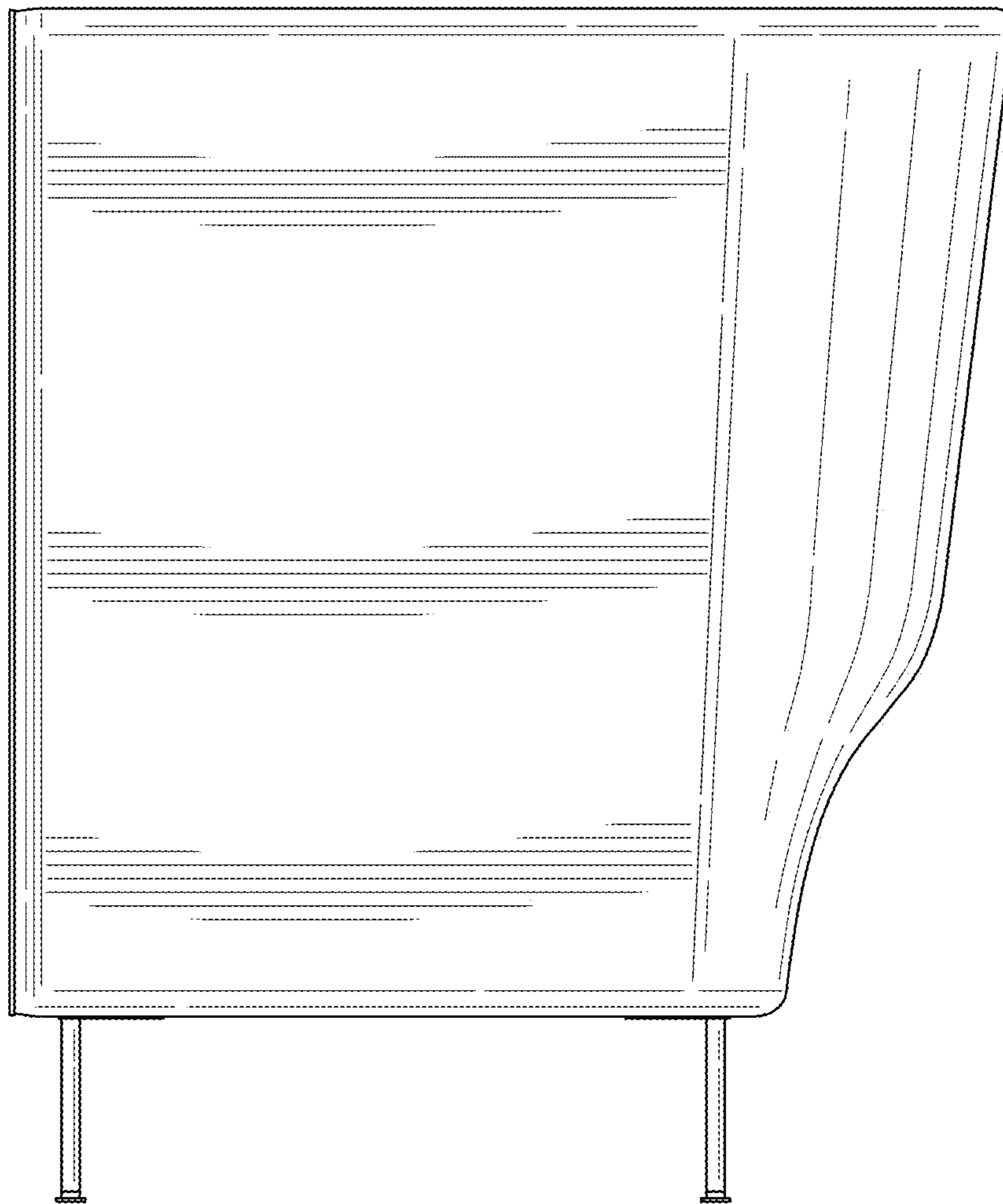

FIG. 7



**FIG. 8**

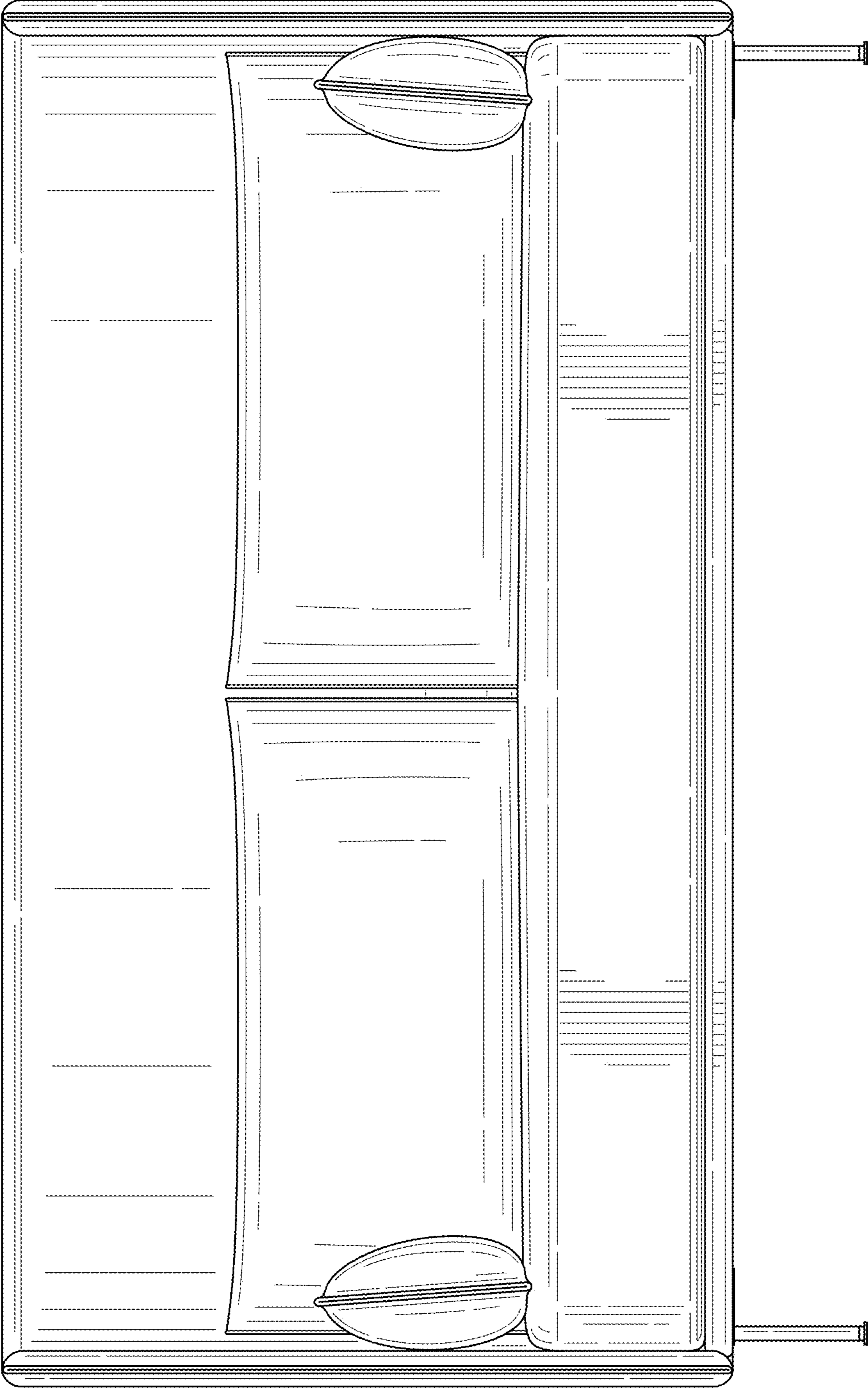

FIG. 9

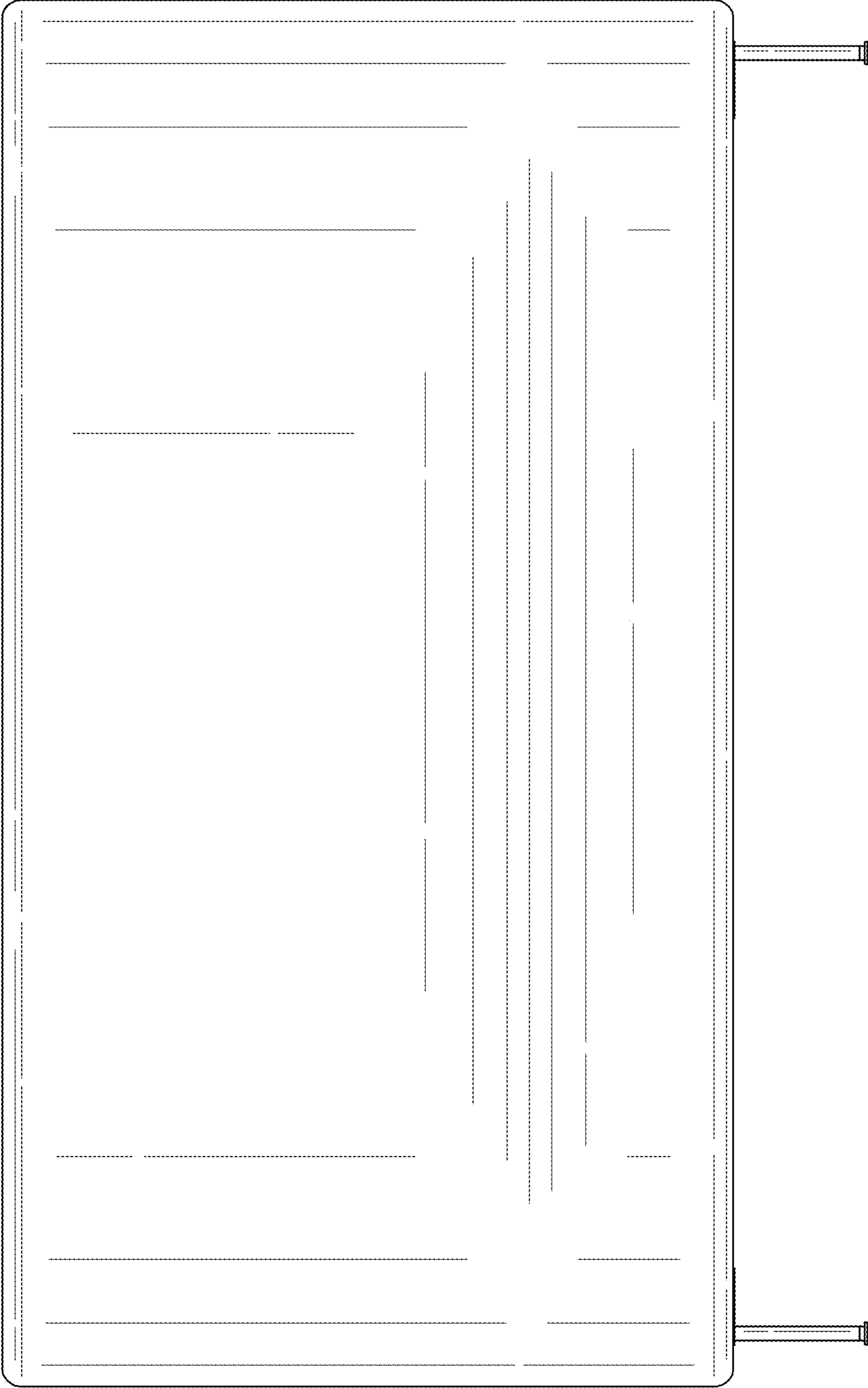

FIG. 10

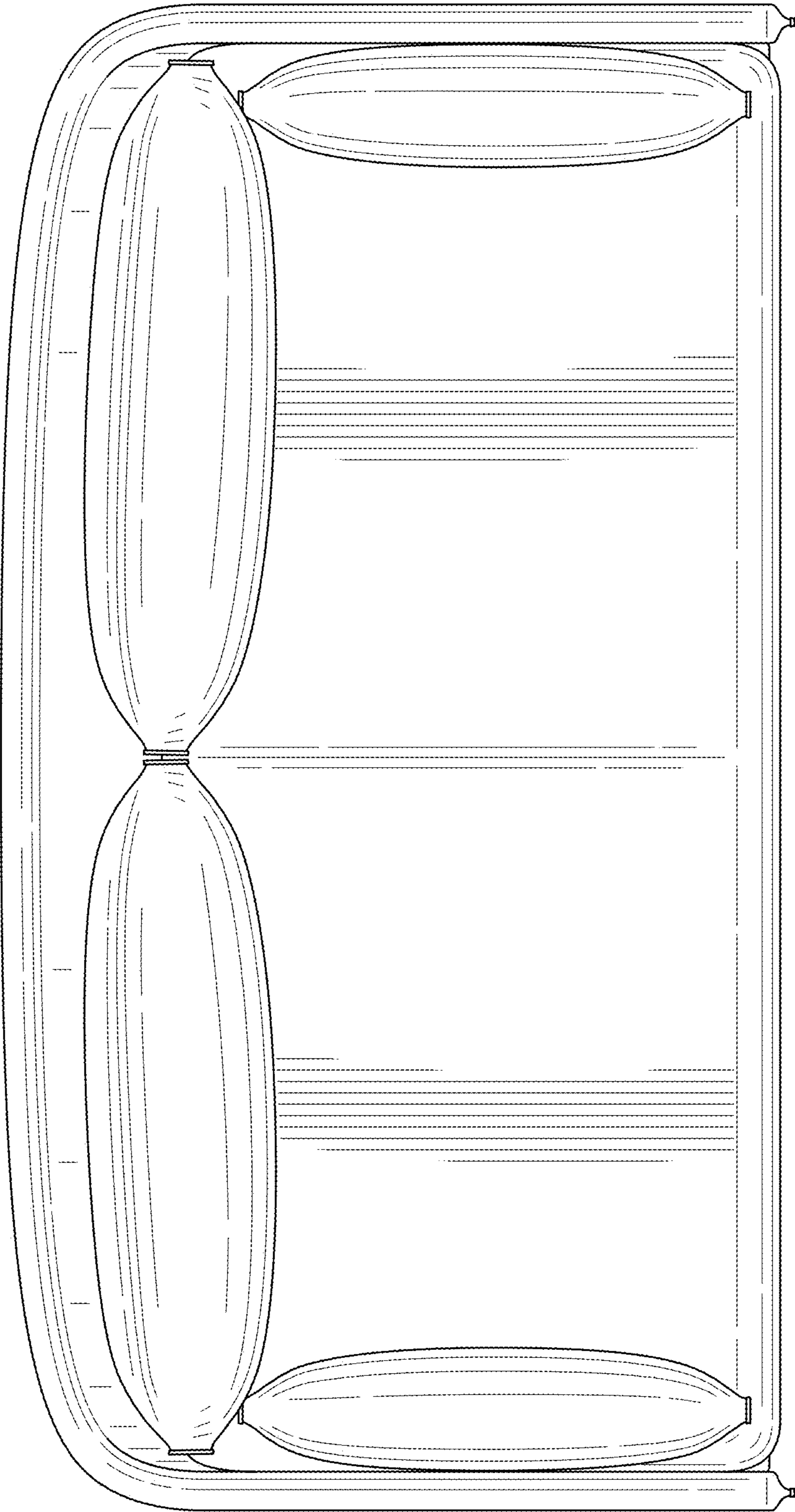

FIG. 11

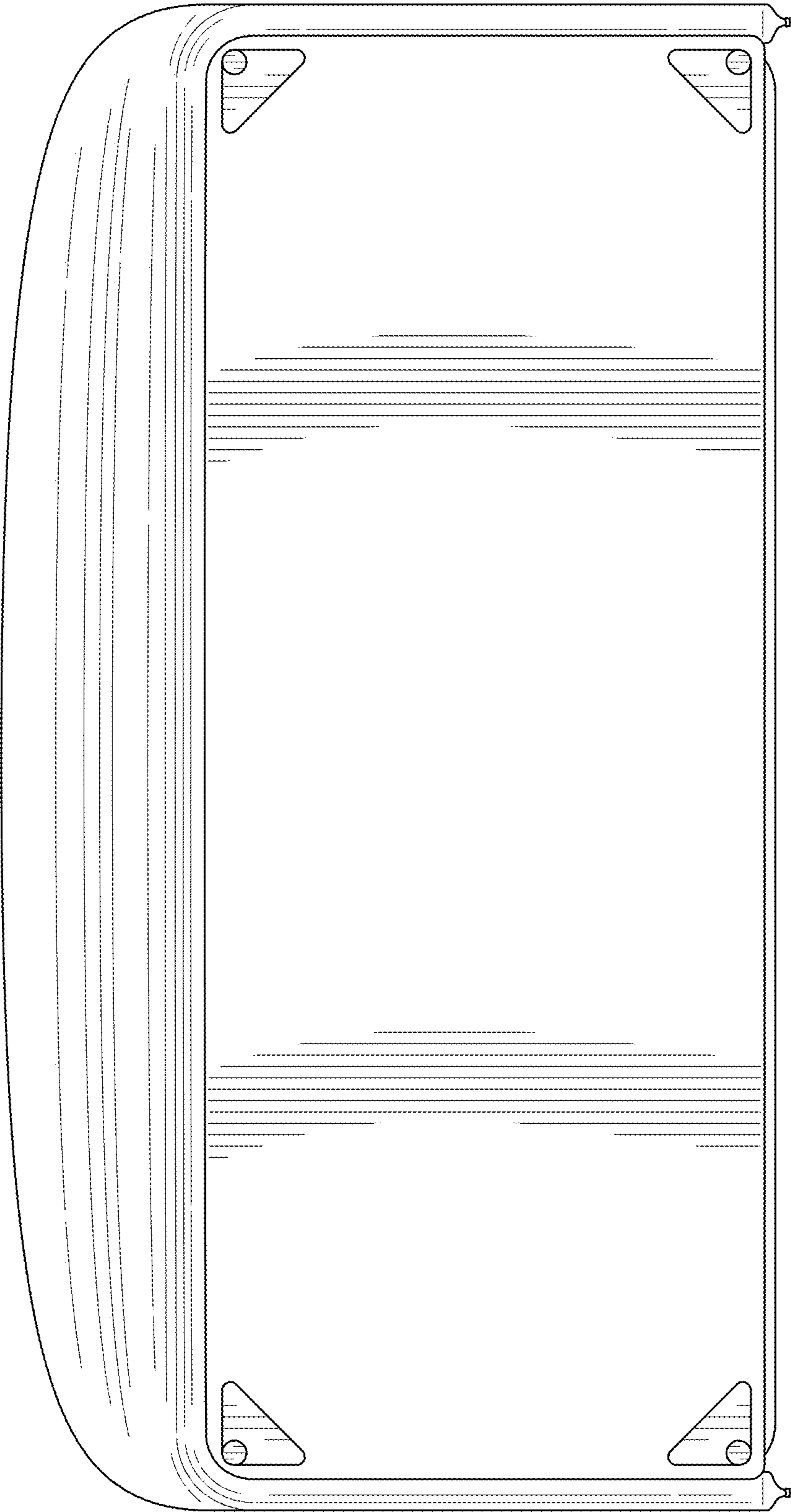

FIG. 12

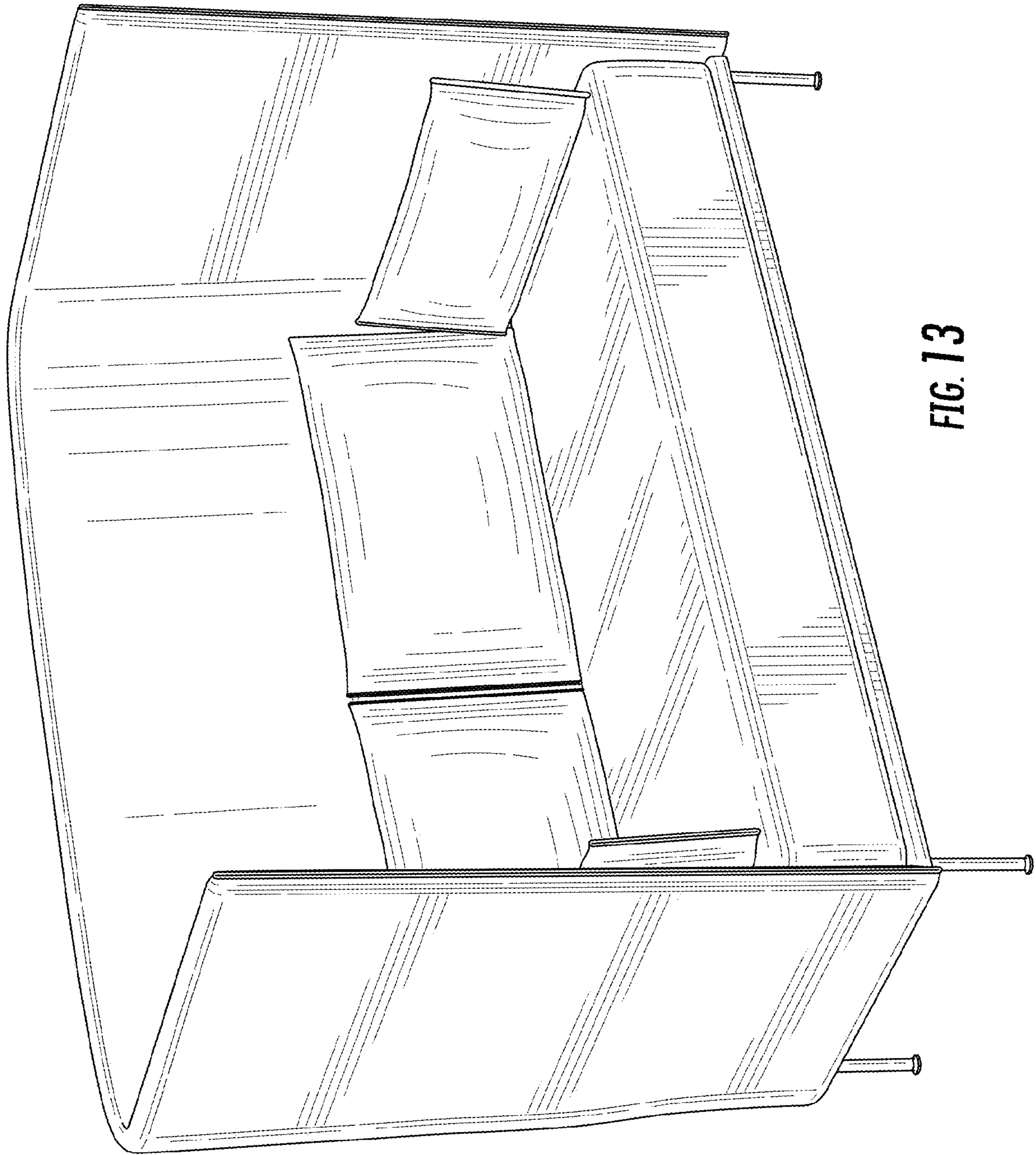

FIG. 13

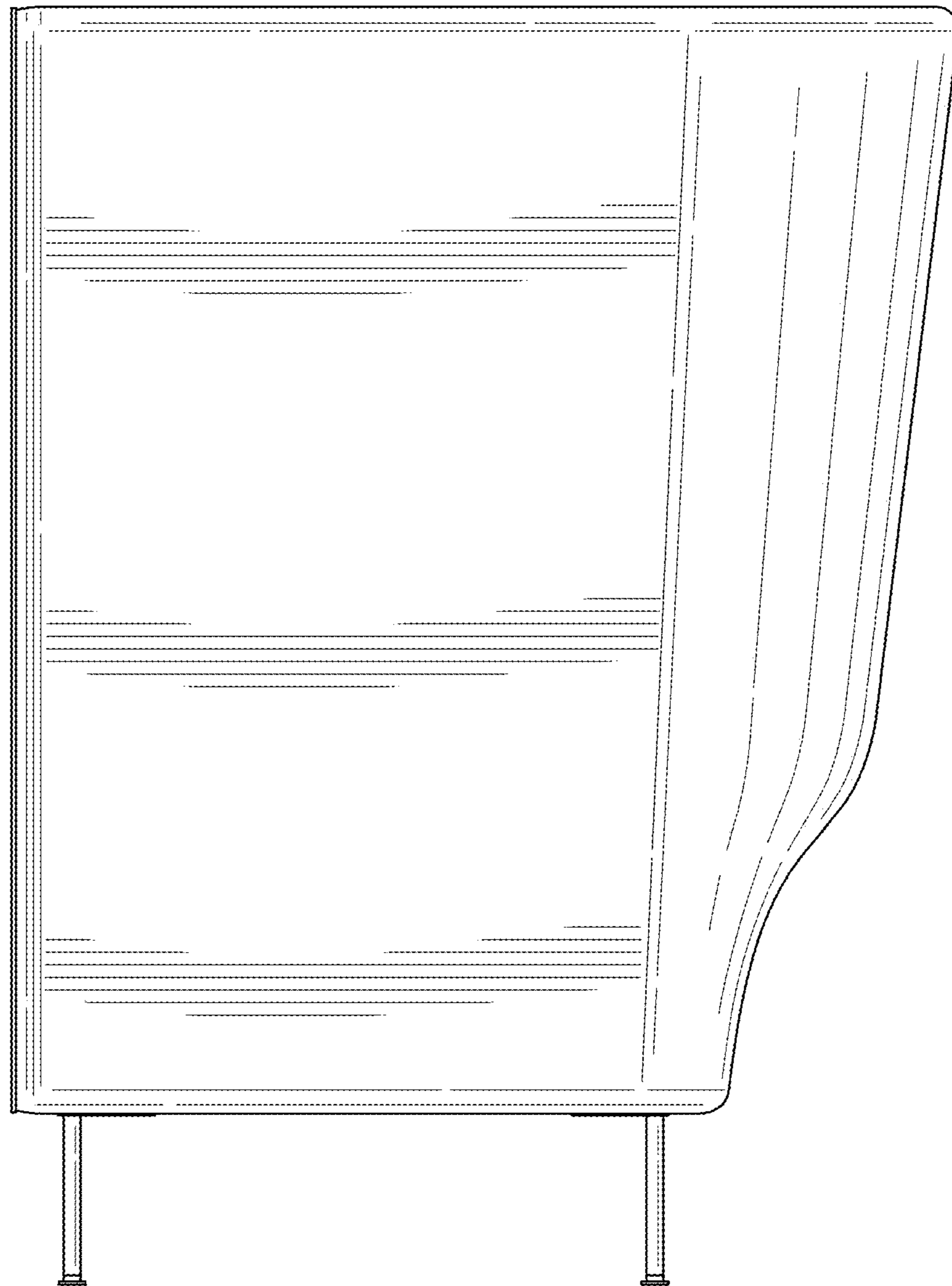

FIG. 14





FIG. 15

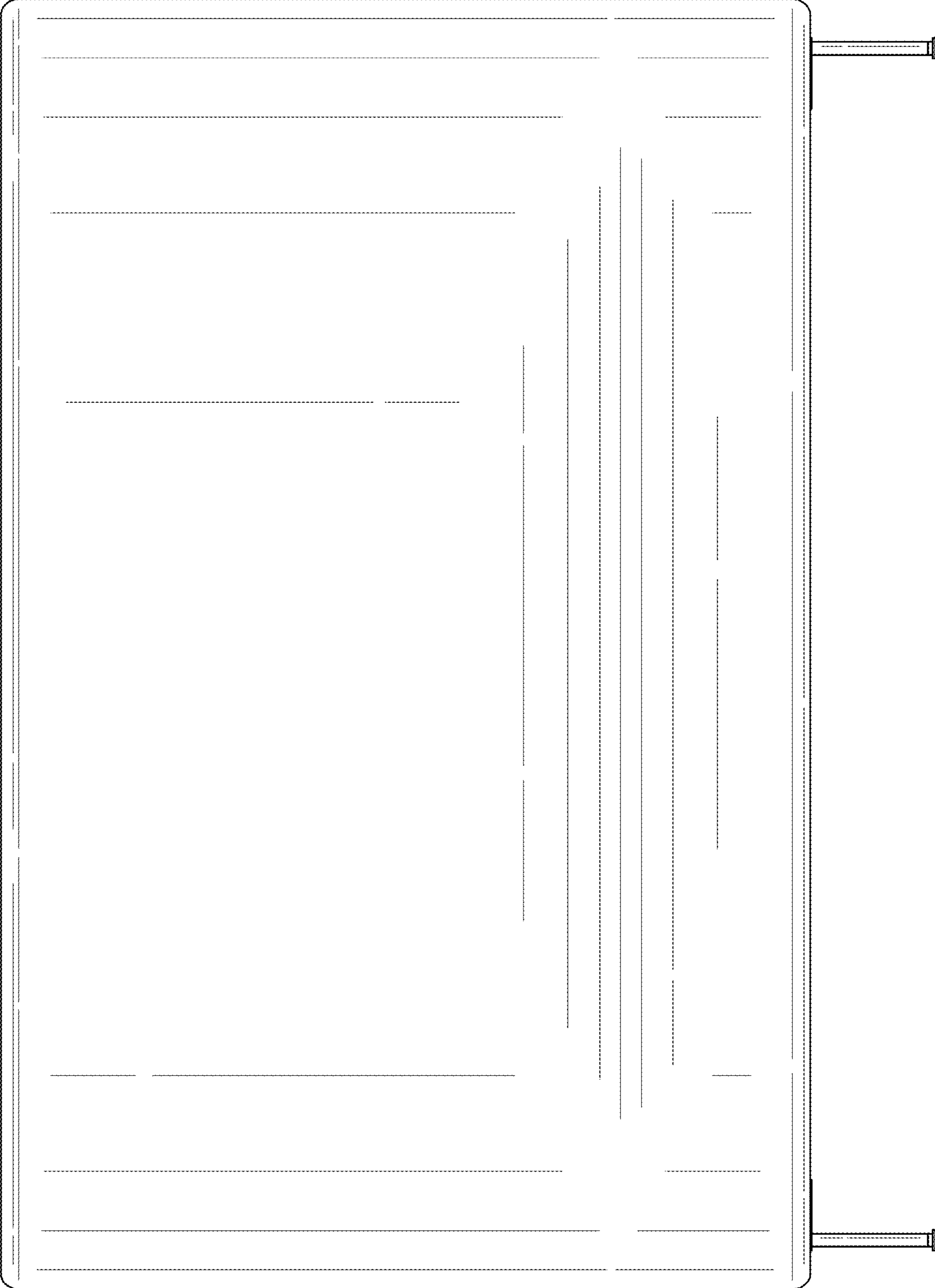

FIG. 16

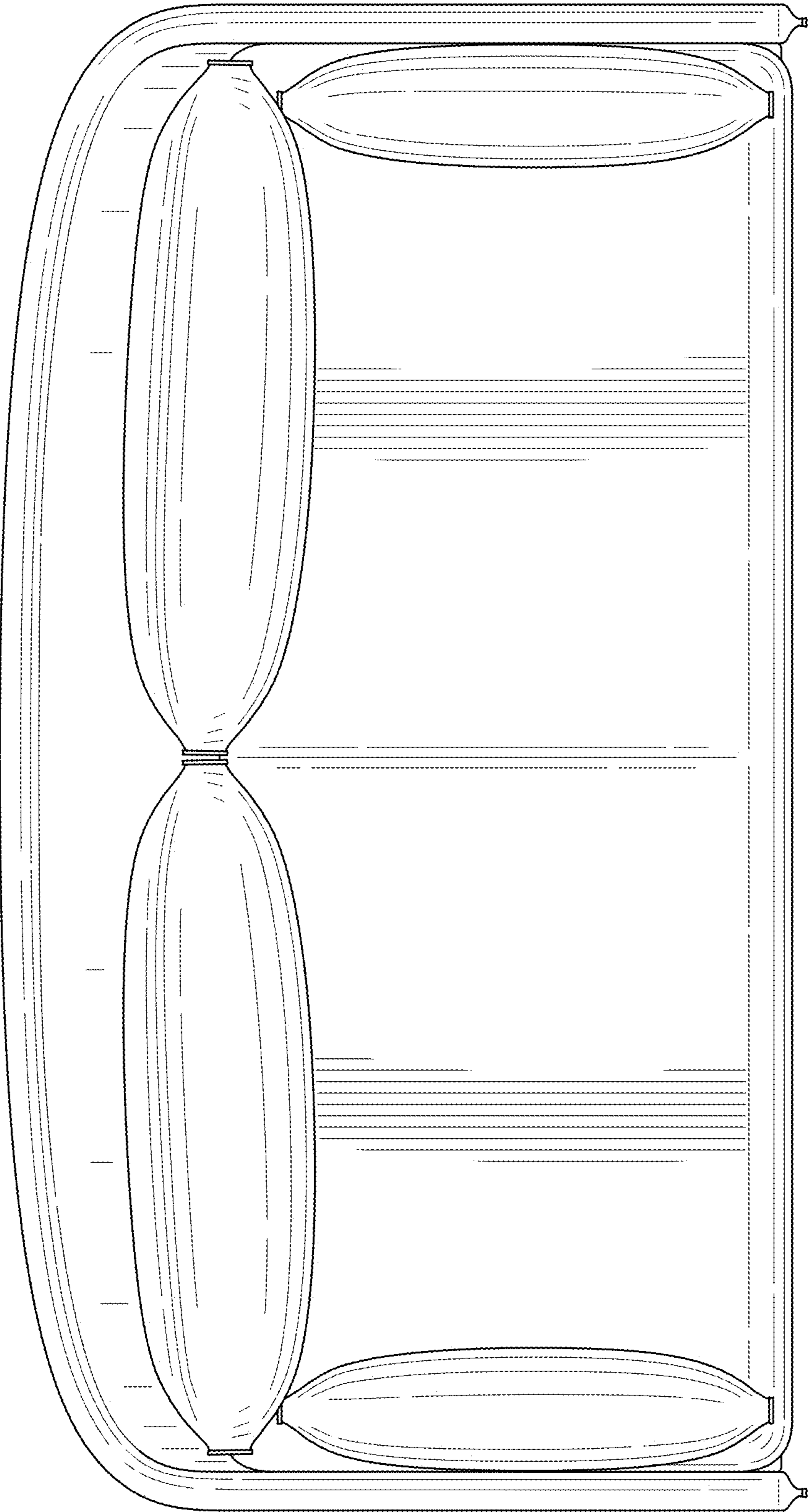

FIG. 17

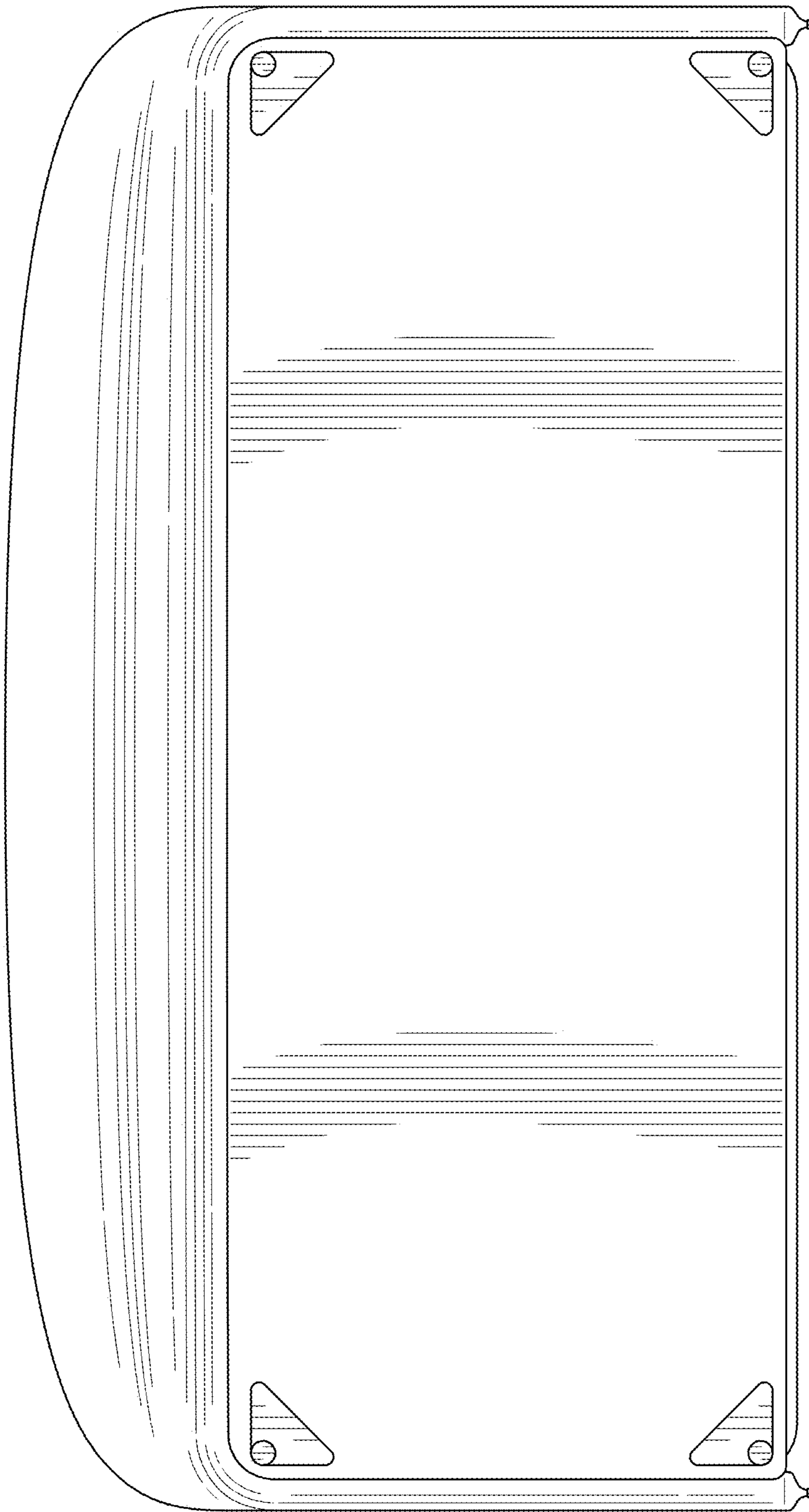

FIG. 18

UNITED STATES PATENT AND TRADEMARK OFFICE  
**CERTIFICATE OF CORRECTION**

PATENT NO. : D885,782 S  
APPLICATION NO. : 29/658734  
DATED : June 2, 2020  
INVENTOR(S) : Stine Gam

Page 1 of 1

It is certified that error appears in the above-identified patent and that said Letters Patent is hereby corrected as shown below:

On the Title Page

Insert the following, after “(22) Filed: Aug. 2, 2018”:

--(30) Foreign Application Priority Data

Feb. 5, 2018 (EM).....004694974-0005

Feb. 5, 2018 (EM).....004694974-0006

Feb. 5, 2018 (EM).....004694974-0007--

Signed and Sealed this  
Thirteenth Day of October, 2020

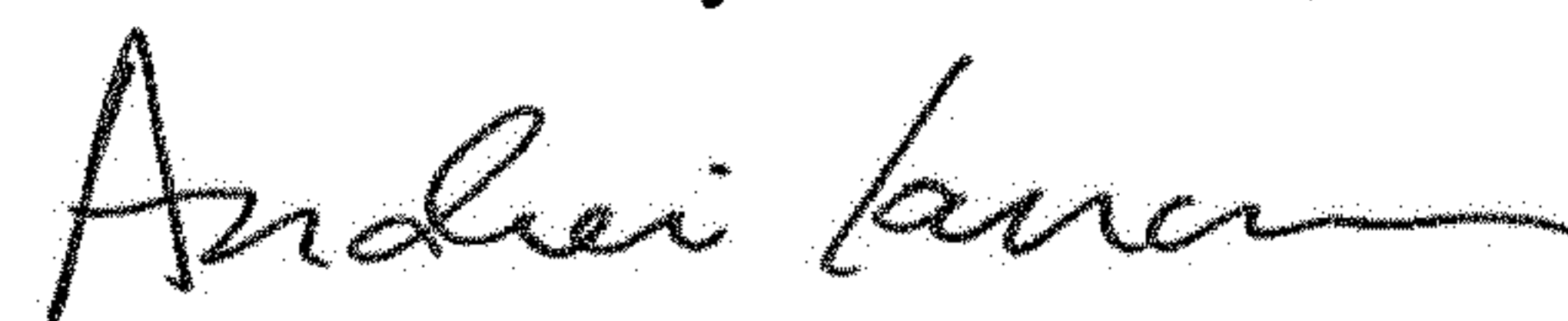

Andrei Iancu  
*Director of the United States Patent and Trademark Office*