



US00D885695S

(12) **United States Design Patent** (10) **Patent No.:** **US D885,695 S**
Kim (45) **Date of Patent:** **** May 26, 2020**

(54) **DOOR FOR DISHWASHER**

(71) Applicant: **Samsung Electronics Co., Ltd.**,
Suwon-si (KR)

(72) Inventor: **Daejong Kim**, Suwon-si (KR)

(73) Assignee: **Samsung Electronics Co., Ltd.**,
Suwon-si (KR)

(**) Term: **15 Years**

(21) Appl. No.: **29/638,194**

(22) Filed: **Feb. 26, 2018**

(30) **Foreign Application Priority Data**

Jan. 2, 2018 (KR) 30-2018-0000122

(51) **LOC (12) Cl.** **15-05**

(52) **U.S. Cl.**
USPC **D32/3**

(58) **Field of Classification Search**
USPC D7/340, 348; D32/2, 3, 6, 8, 10, 25
(Continued)

(56) **References Cited**

U.S. PATENT DOCUMENTS

D665,957 S * 8/2012 Eng D32/2
D706,502 S * 6/2014 Eng D32/3
(Continued)

Primary Examiner — Michelle E. Wilson

(74) *Attorney, Agent, or Firm* — NSIP Law

(57) **CLAIM**

I claim the ornamental design for a door for dishwasher, as shown and described.

DESCRIPTION

FIG. 1 is a front perspective view of a first embodiment of a door for dishwasher showing my new design;

FIG. 2 is a front view thereof;
FIG. 3 is a rear view thereof;
FIG. 4 is a left-side view thereof;
FIG. 5 is a right-side view thereof;
FIG. 6 is a top view thereof;
FIG. 7 is a bottom view thereof;
FIG. 8 is a cross-sectional view taken along the line 8-8- of FIG. 2;
FIG. 9 is a front perspective view thereof shown in an example environment;
FIG. 10 is a front perspective view of a second embodiment of a door for dishwasher showing my new design;
FIG. 11 is a front view thereof;
FIG. 12 is a rear view thereof;
FIG. 13 is a left-side view thereof;
FIG. 14 is a right-side view thereof;
FIG. 15 is a top view thereof;
FIG. 16 is a bottom view thereof;
FIG. 17 is a cross-sectional view taken along the line 17-17- of FIG. 11;
FIG. 18 is a front perspective view thereof shown in an example environment;
FIG. 19 is a front perspective view of a third embodiment of a door for dishwasher showing my new design;
FIG. 20 is a front view thereof;
FIG. 21 is a rear view thereof;
FIG. 22 is a left-side view thereof;
FIG. 23 is a right-side view thereof;
FIG. 24 is a top view thereof;
FIG. 25 is a bottom view thereof;
FIG. 26 is a cross-sectional view taken along the line 26-26- of FIG. 20;
FIG. 27 is a front perspective view thereof shown in an example environment;
FIG. 28 is a front perspective view of a fourth embodiment of a door for dishwasher showing my new design;
FIG. 29 is a front view thereof;
FIG. 30 is a rear view thereof;
FIG. 31 is a left-side view thereof;
FIG. 32 is a right-side view thereof;
FIG. 33 is a top view thereof;
FIG. 34 is a bottom view thereof;
FIG. 35 is a cross-sectional view taken along the line 35-35- of FIG. 29; and,

(Continued)

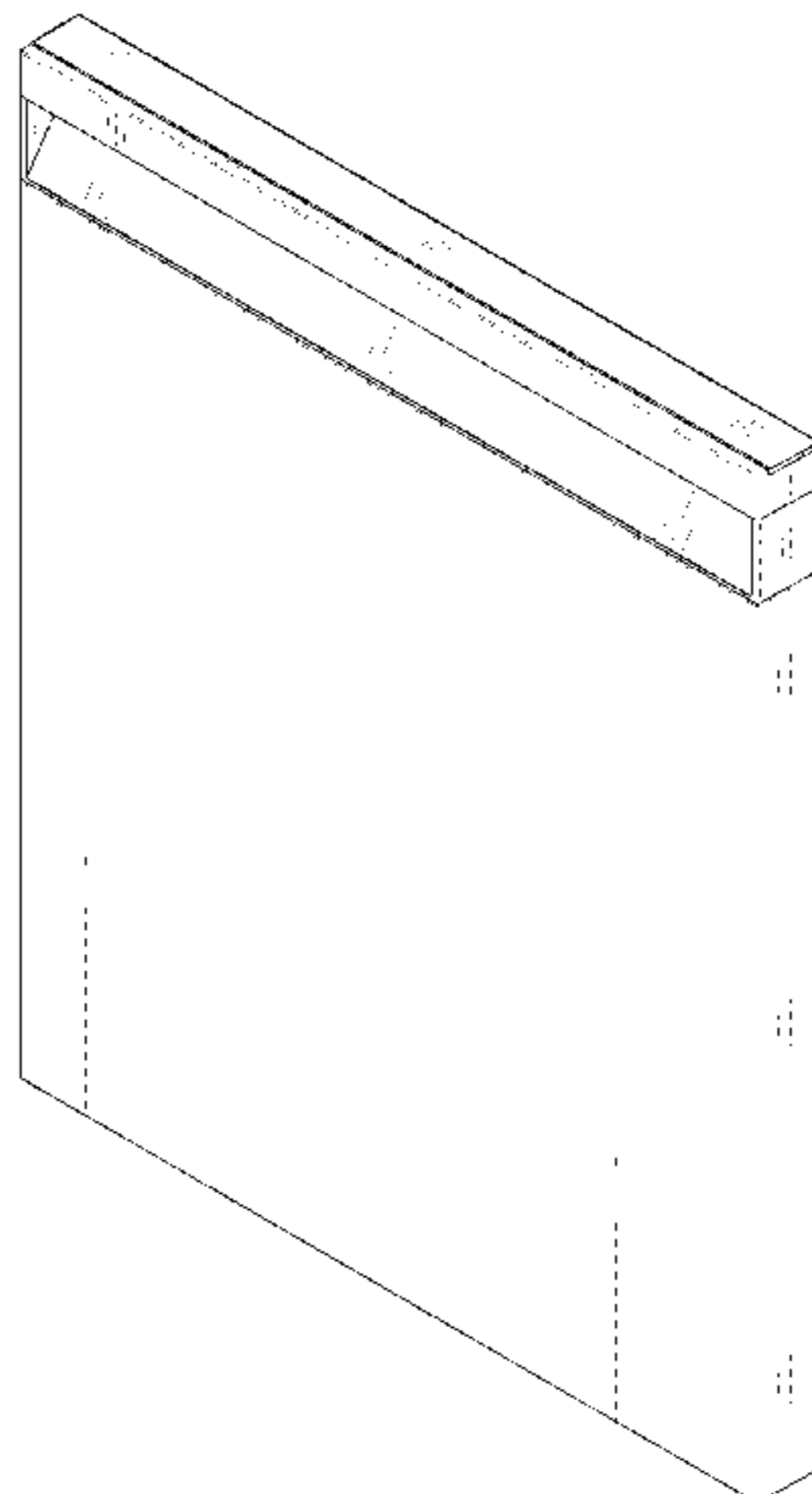

FIG. 36 is a front perspective view thereof shown in an example environment.

The broken lines in the figures show portions of the door for dishwasher and environmental structure and form no part of the claimed design.

1 Claim, 28 Drawing Sheets

(58) Field of Classification Search

CPC A47L 15/22; A47L 15/449; A47L 15/4463;
A47L 15/4445; A47L 15/4295; A47L
15/0055; A47L 15/0057; A47L 2301/04;
A47L 2501/07

See application file for complete search history.

(56) References Cited

U.S. PATENT DOCUMENTS

D734,902	S	*	7/2015	Eng	D32/3
D756,046	S	*	5/2016	Roberson	D32/3
D765,923	S	*	9/2016	Roberson	D32/3
D778,008	S	*	1/2017	Roberson	D32/3
D827,951	S	*	9/2018	Lee	D32/2
D860,552	S	*	9/2019	Roberson	D32/3
D864,504	S	*	10/2019	Kim	D32/2
D866,883	S	*	11/2019	Kim	D32/2
2003/0205954	A1	*	11/2003	Oyler	A47L 15/4265 312/311

* cited by examiner

FIG. 1

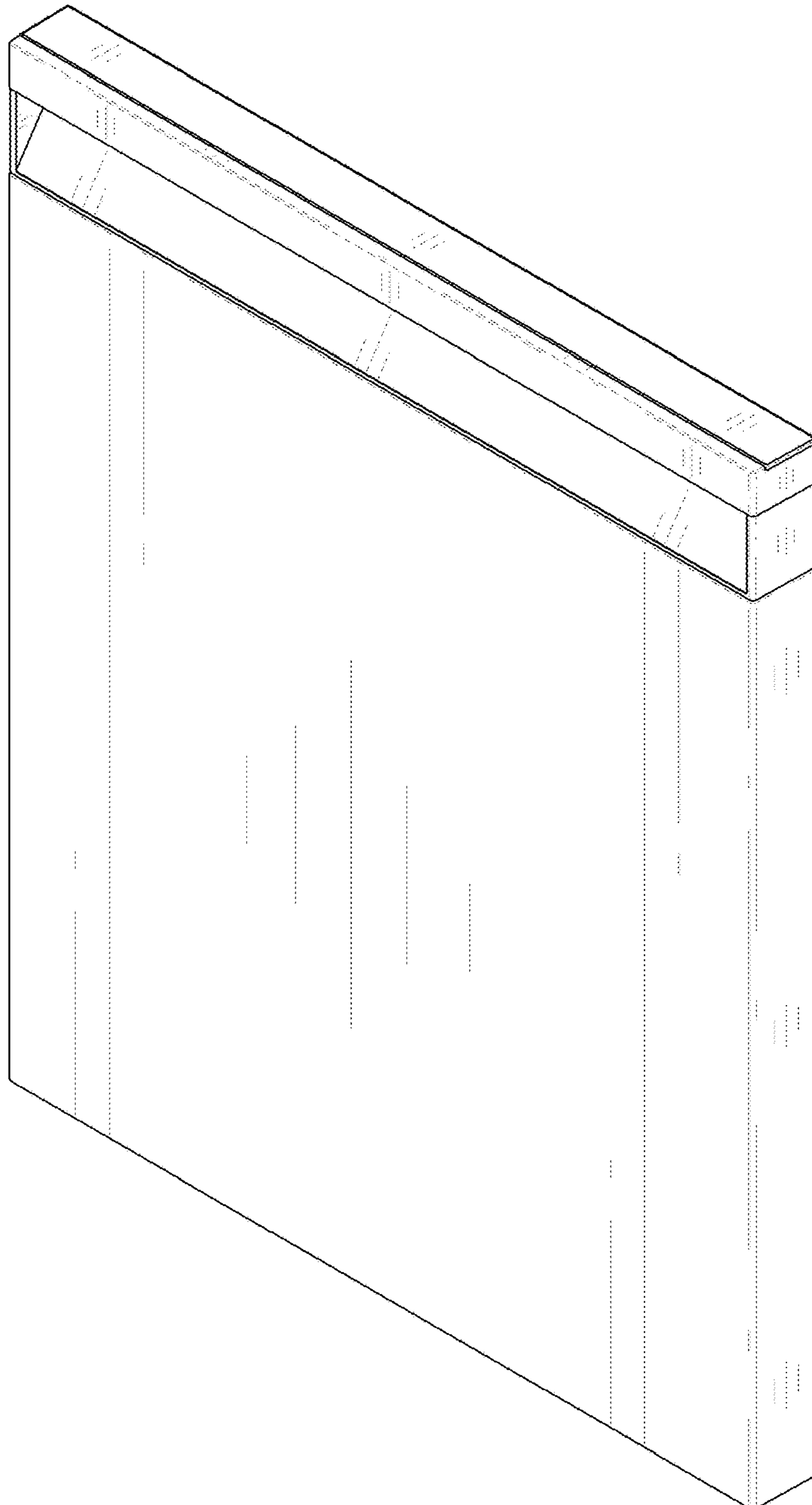

FIG. 2

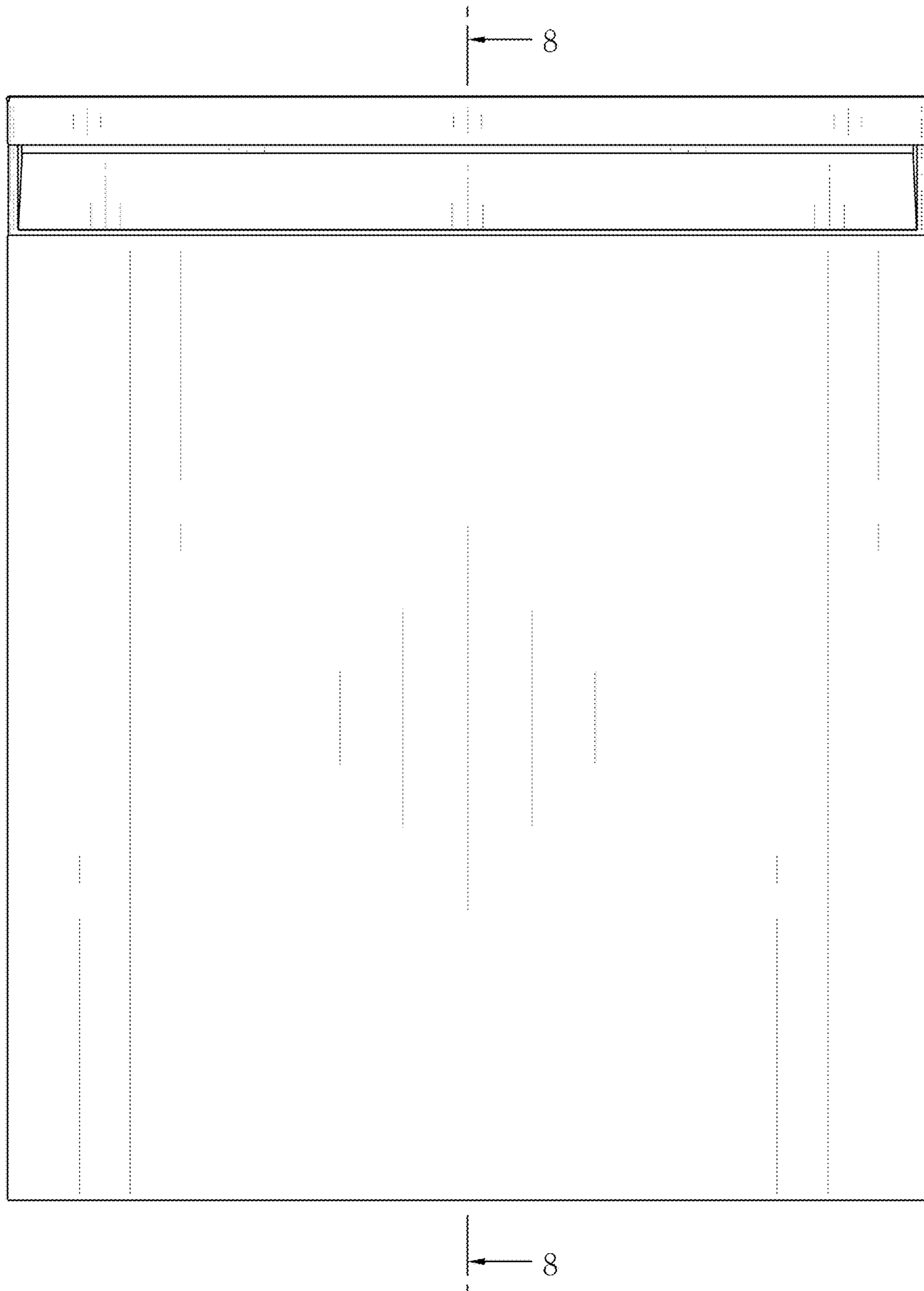

FIG. 3

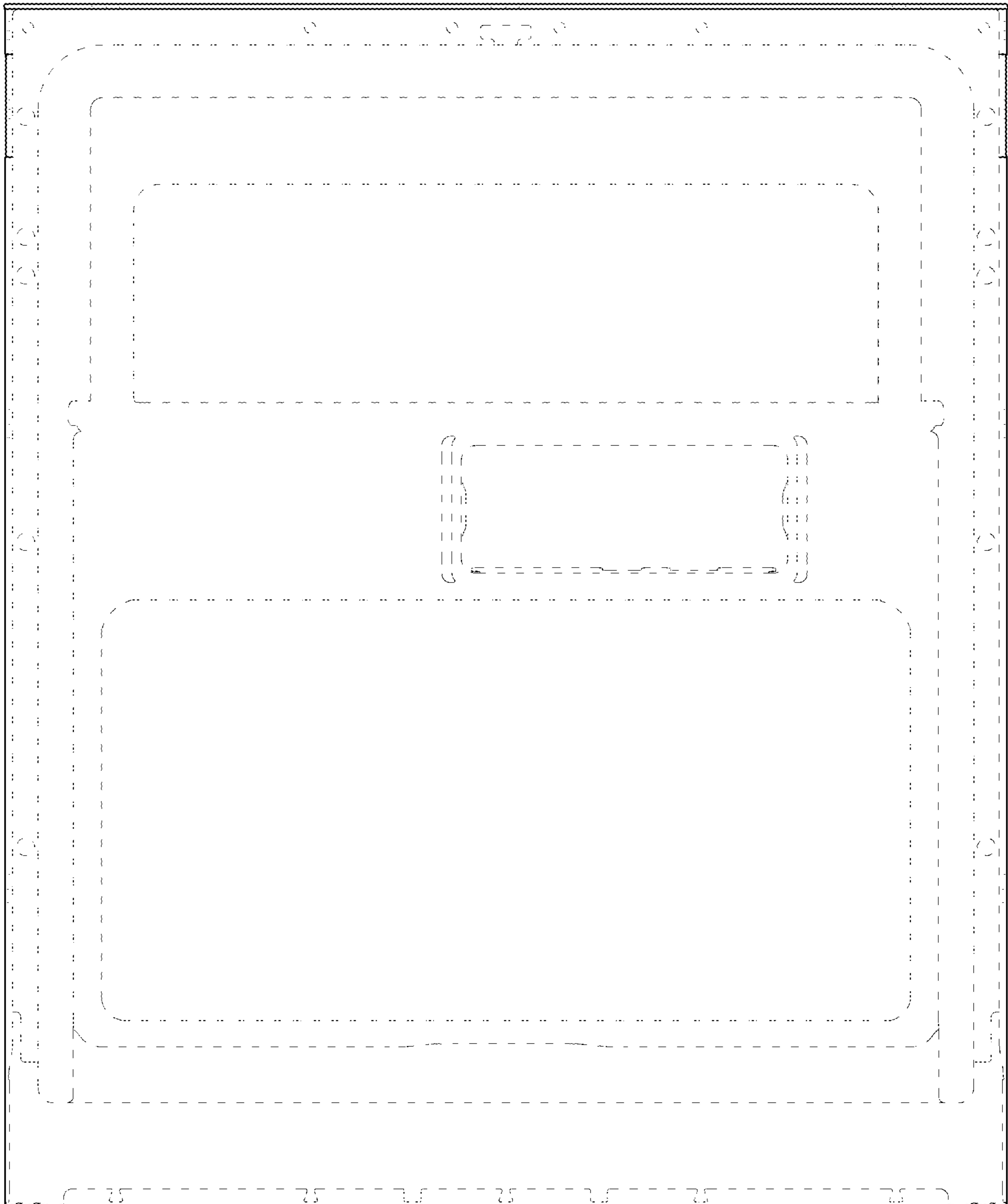

FIG. 4

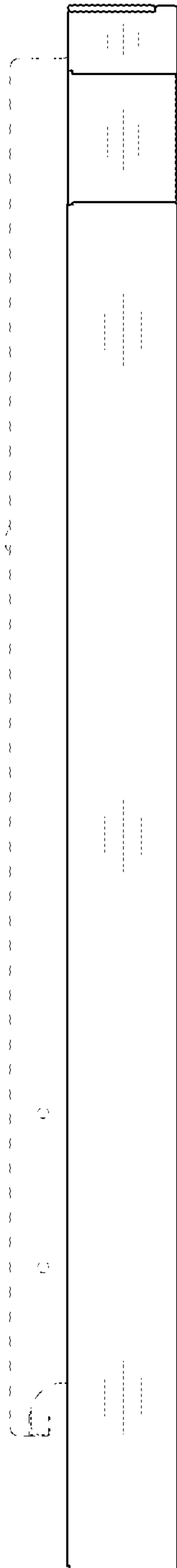

FIG. 5

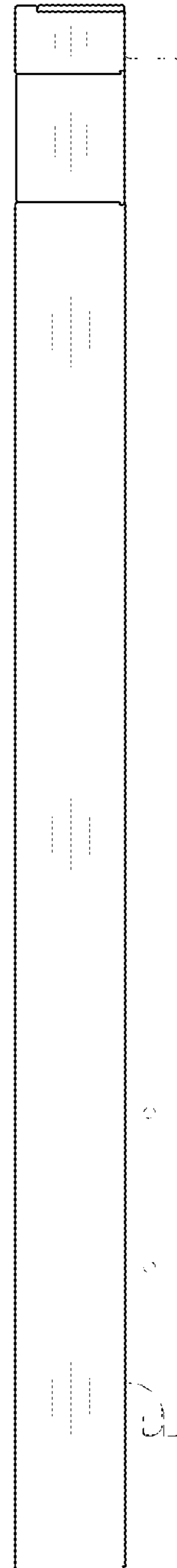

FIG. 6



FIG. 7

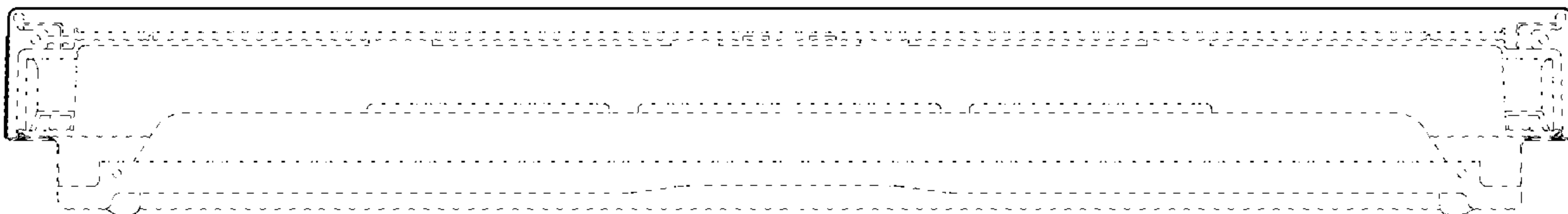

FIG. 8

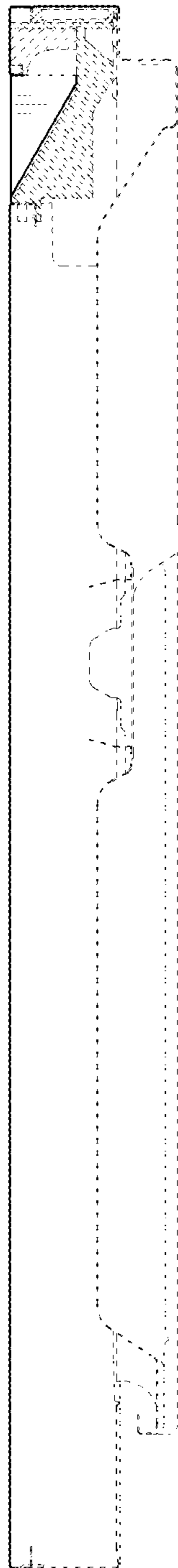

FIG. 9

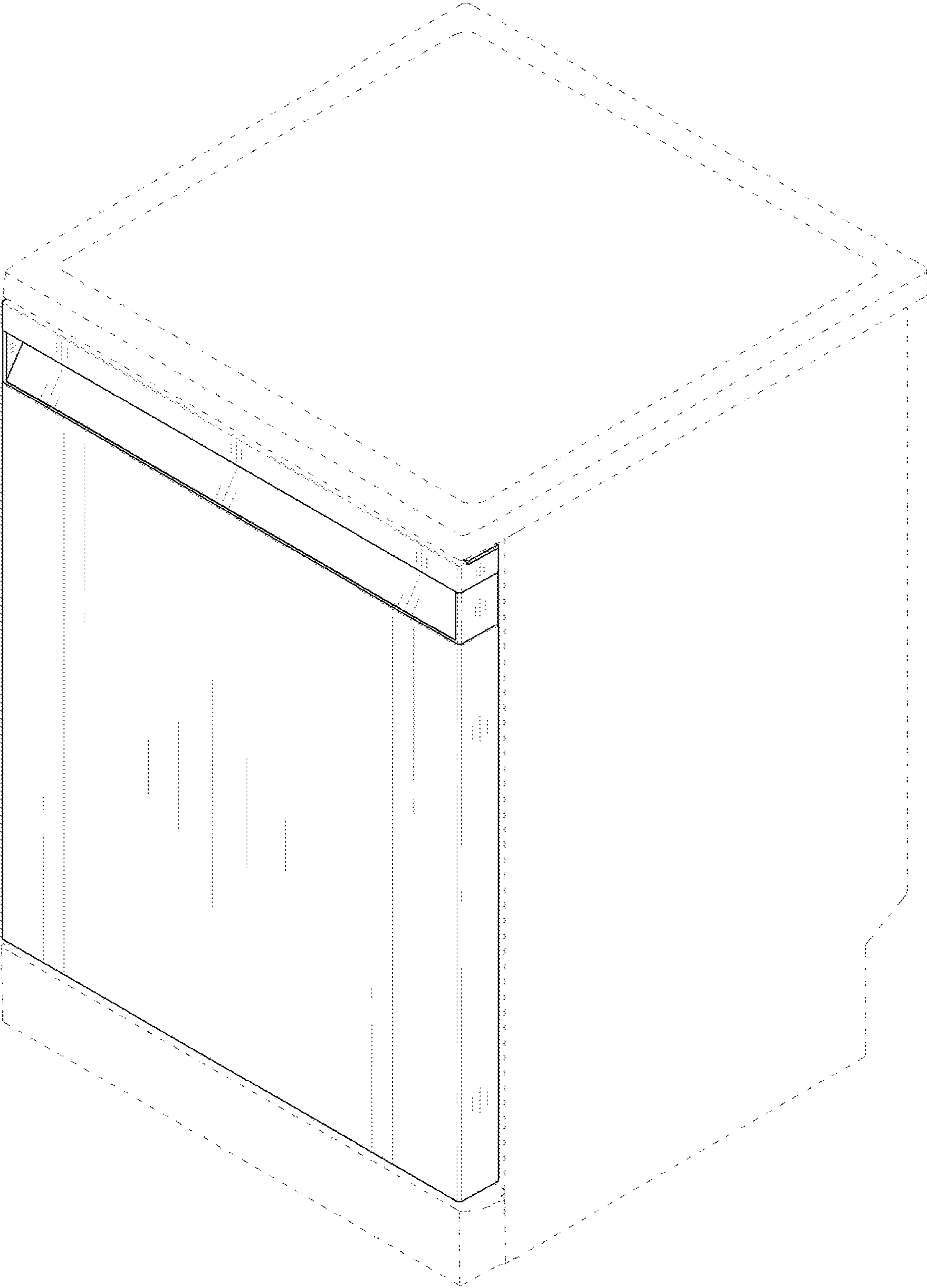

FIG. 10

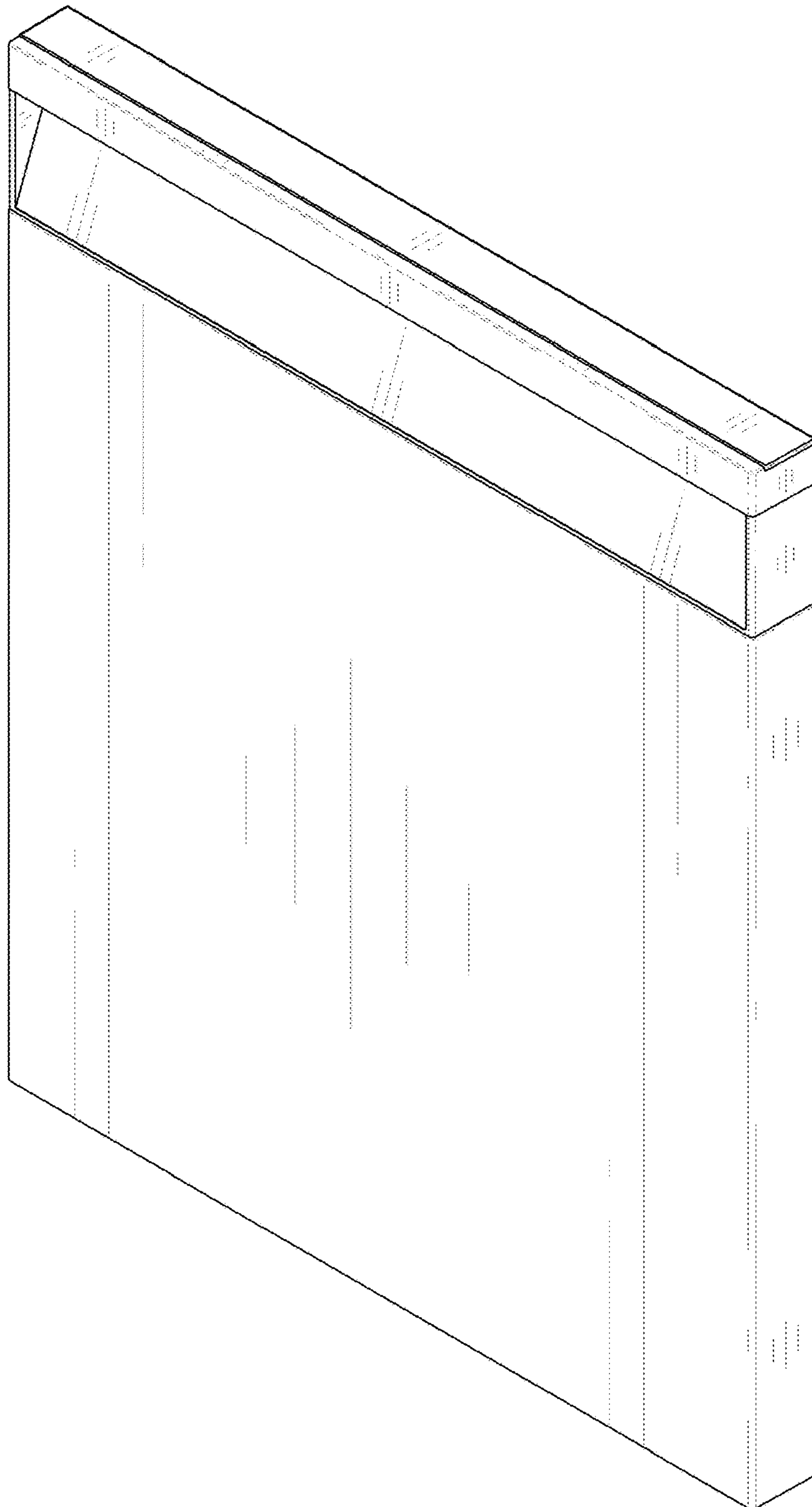

FIG. 11

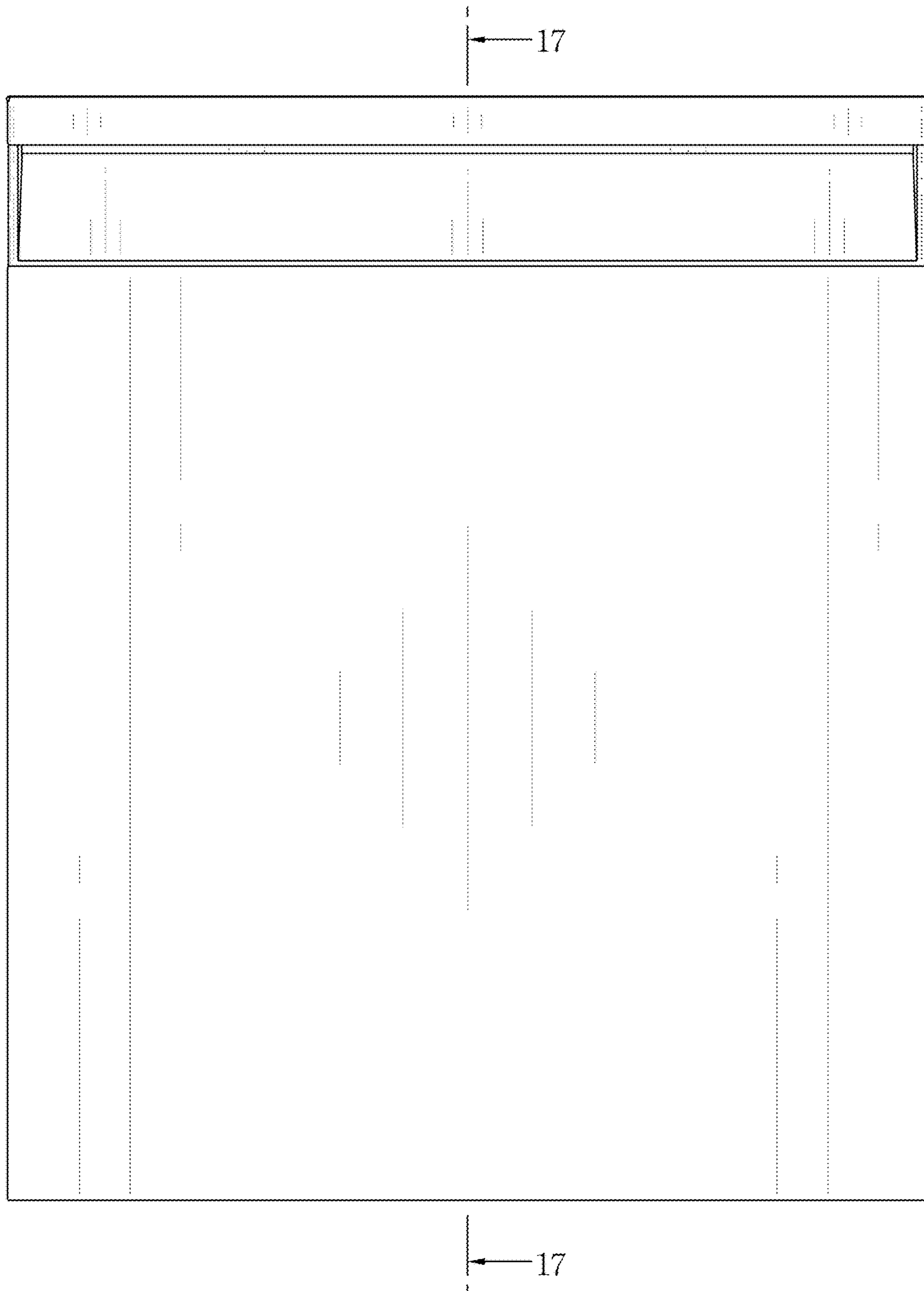

FIG. 12

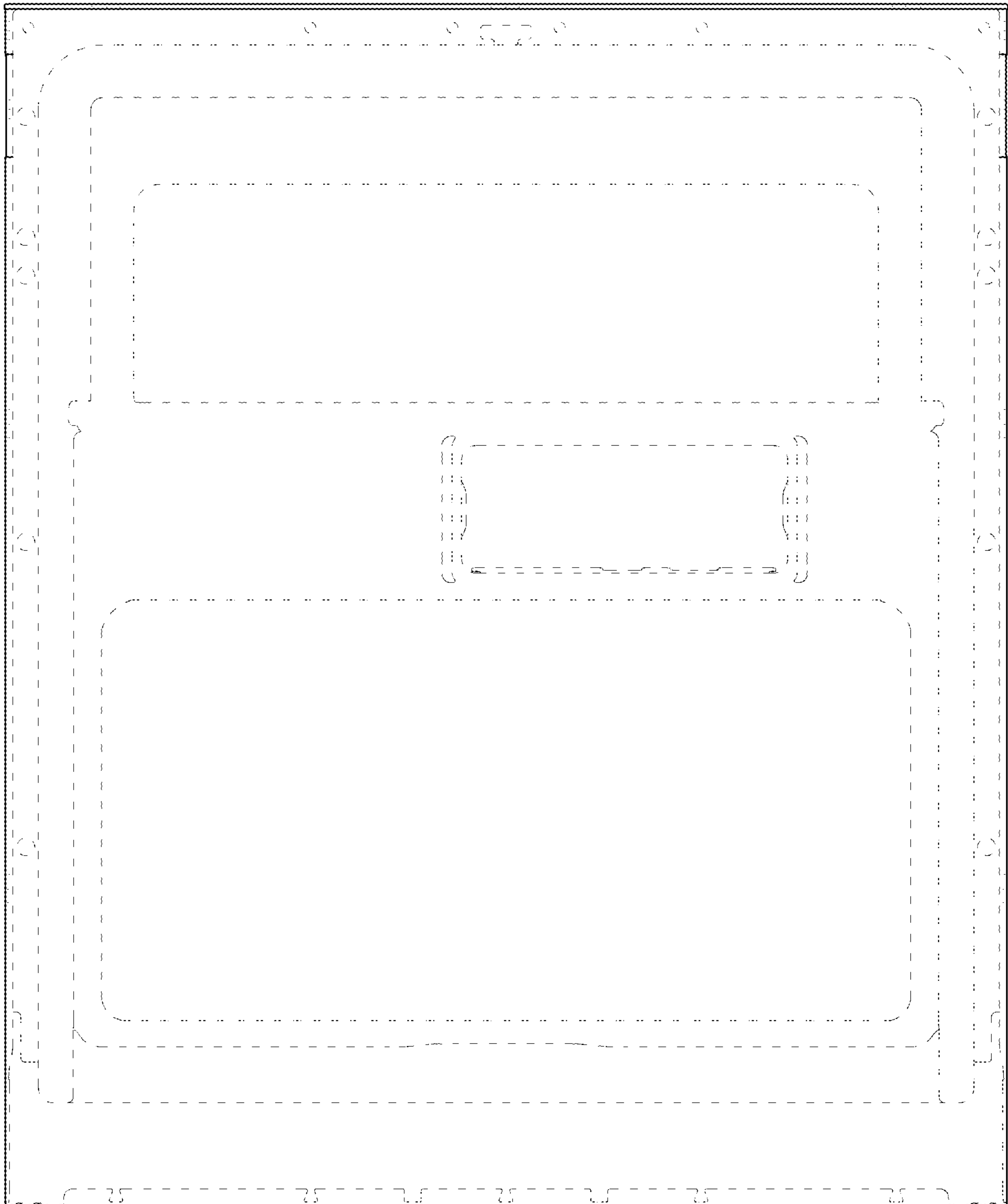

FIG. 13

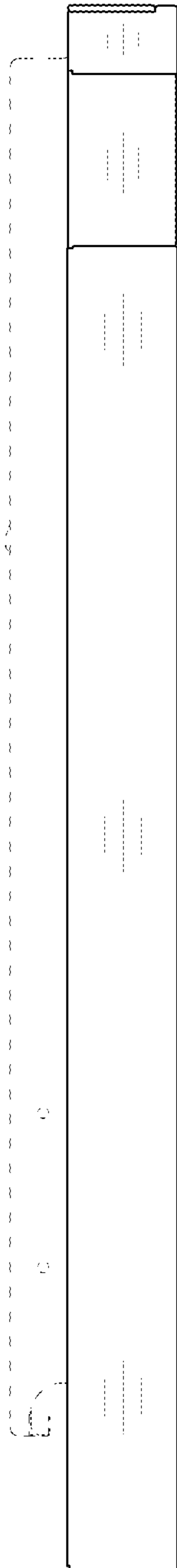

FIG. 14

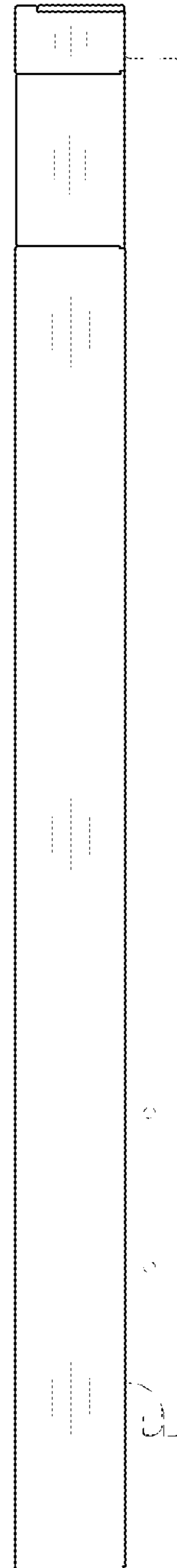

FIG. 15

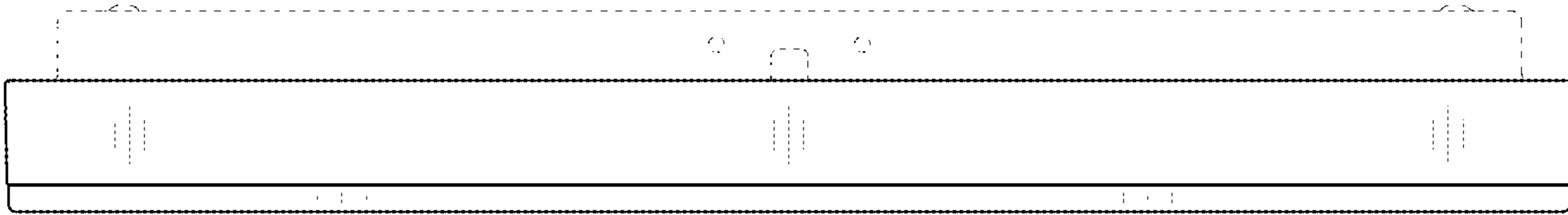

FIG. 16

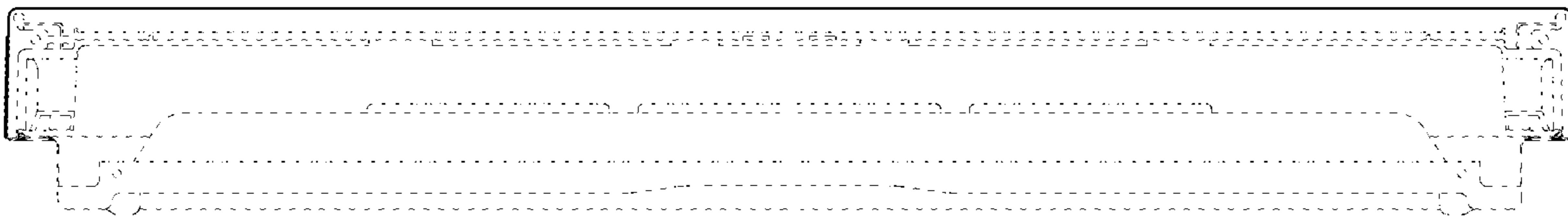

FIG. 17

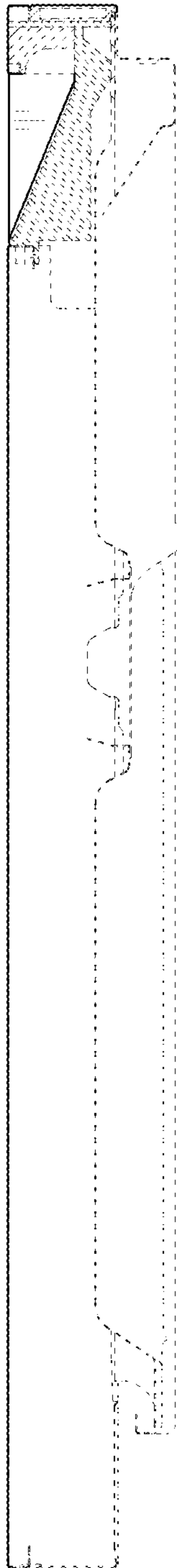

FIG. 18

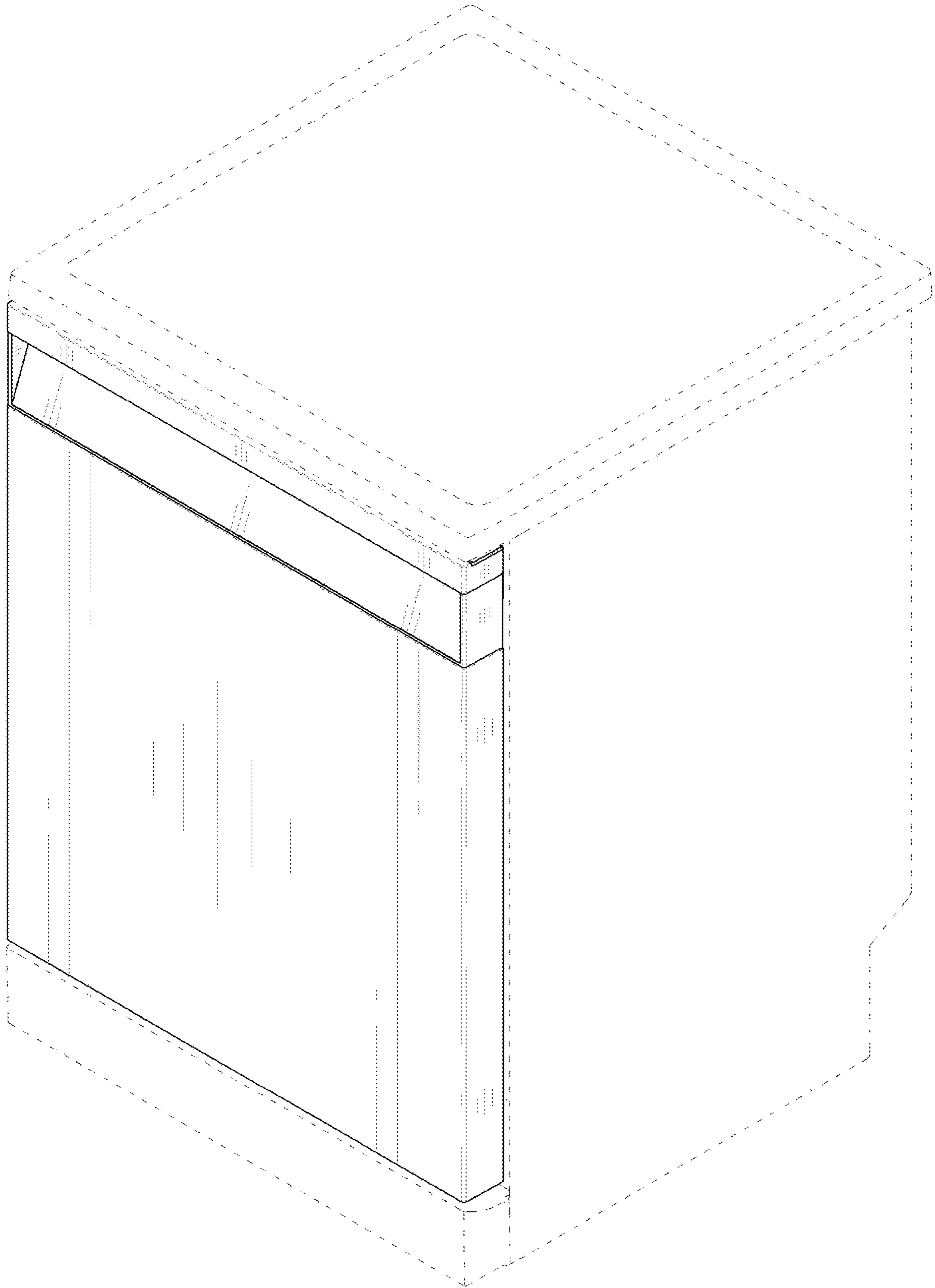

FIG. 19

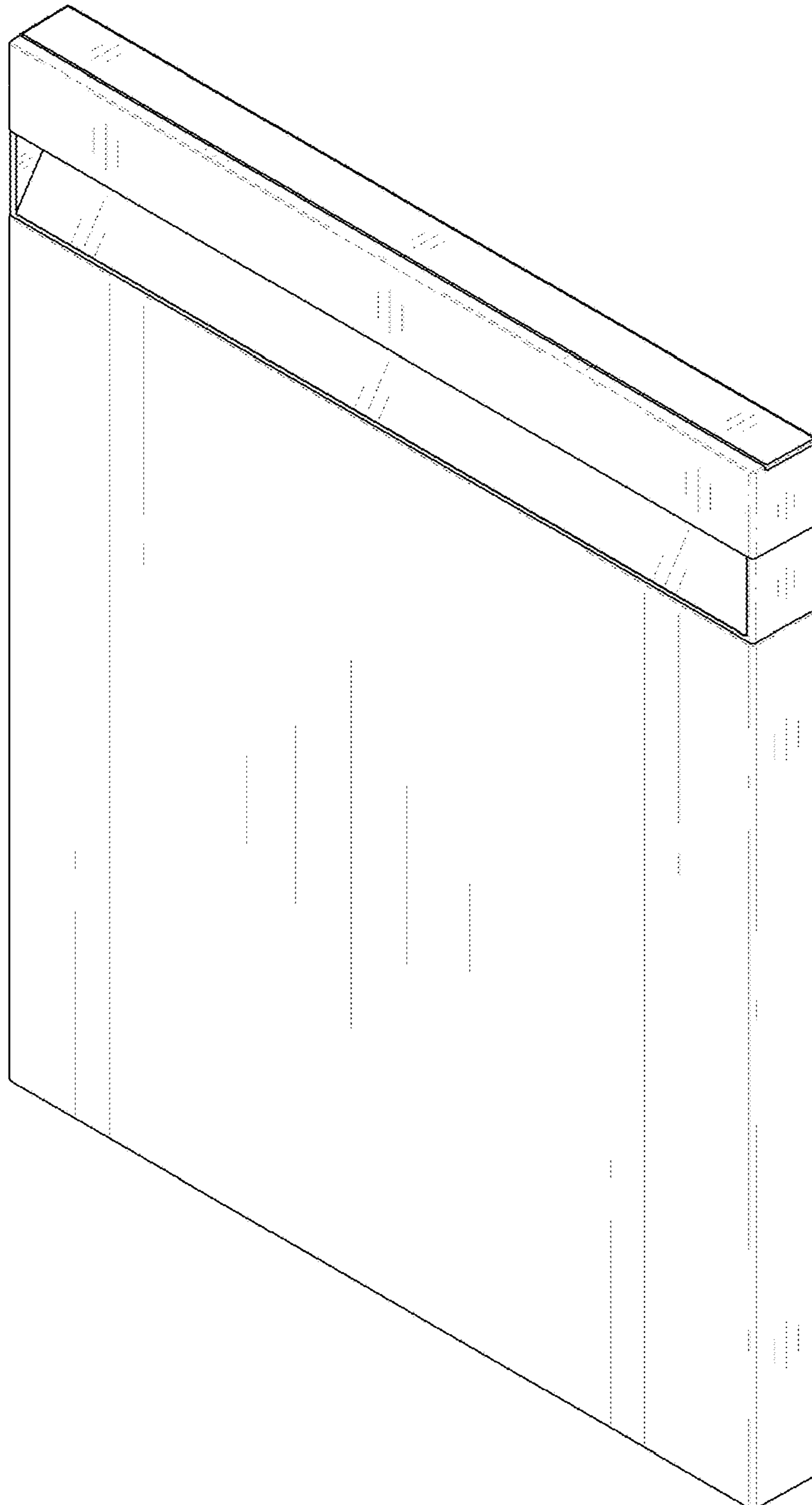

FIG. 20

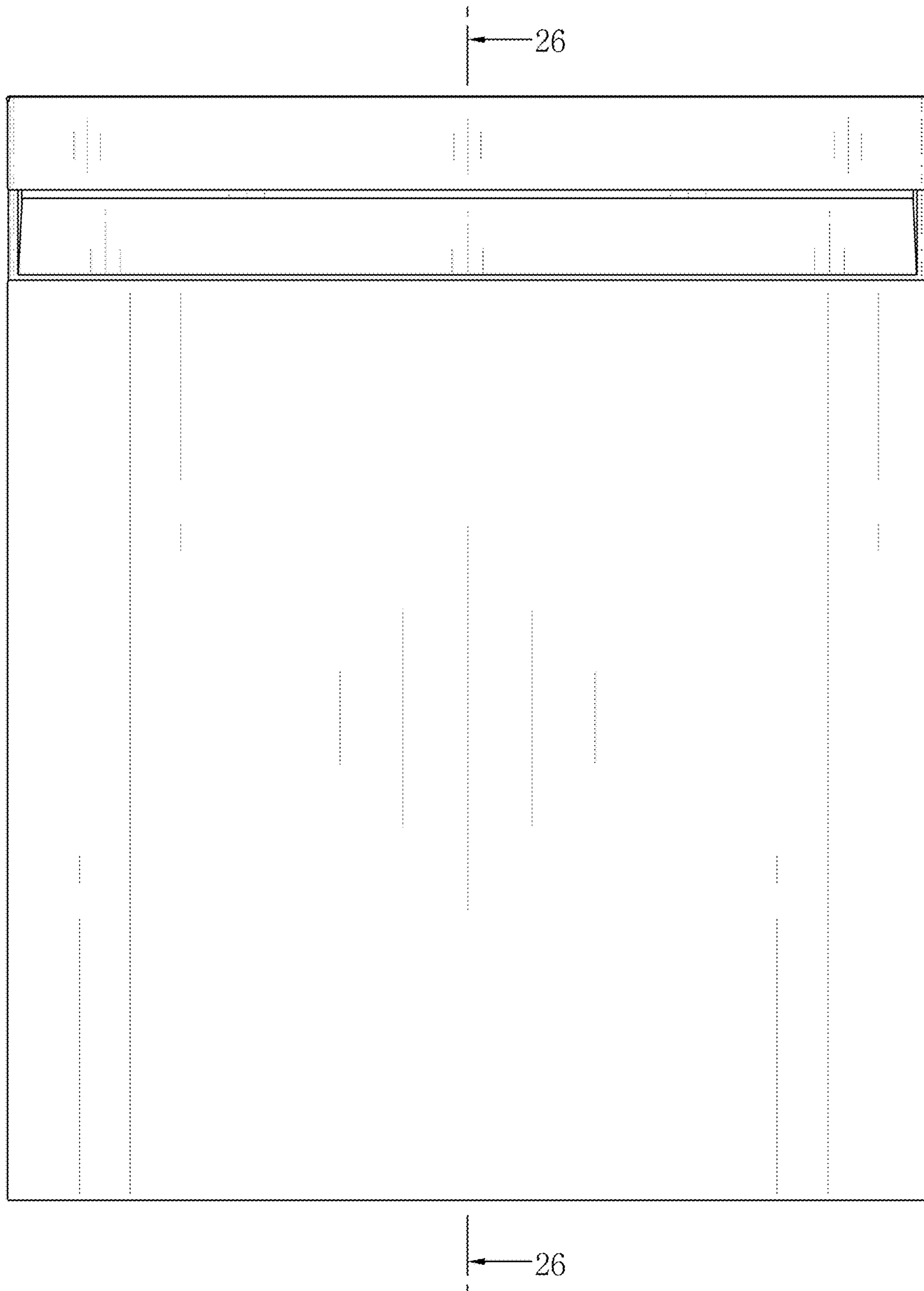

FIG. 21

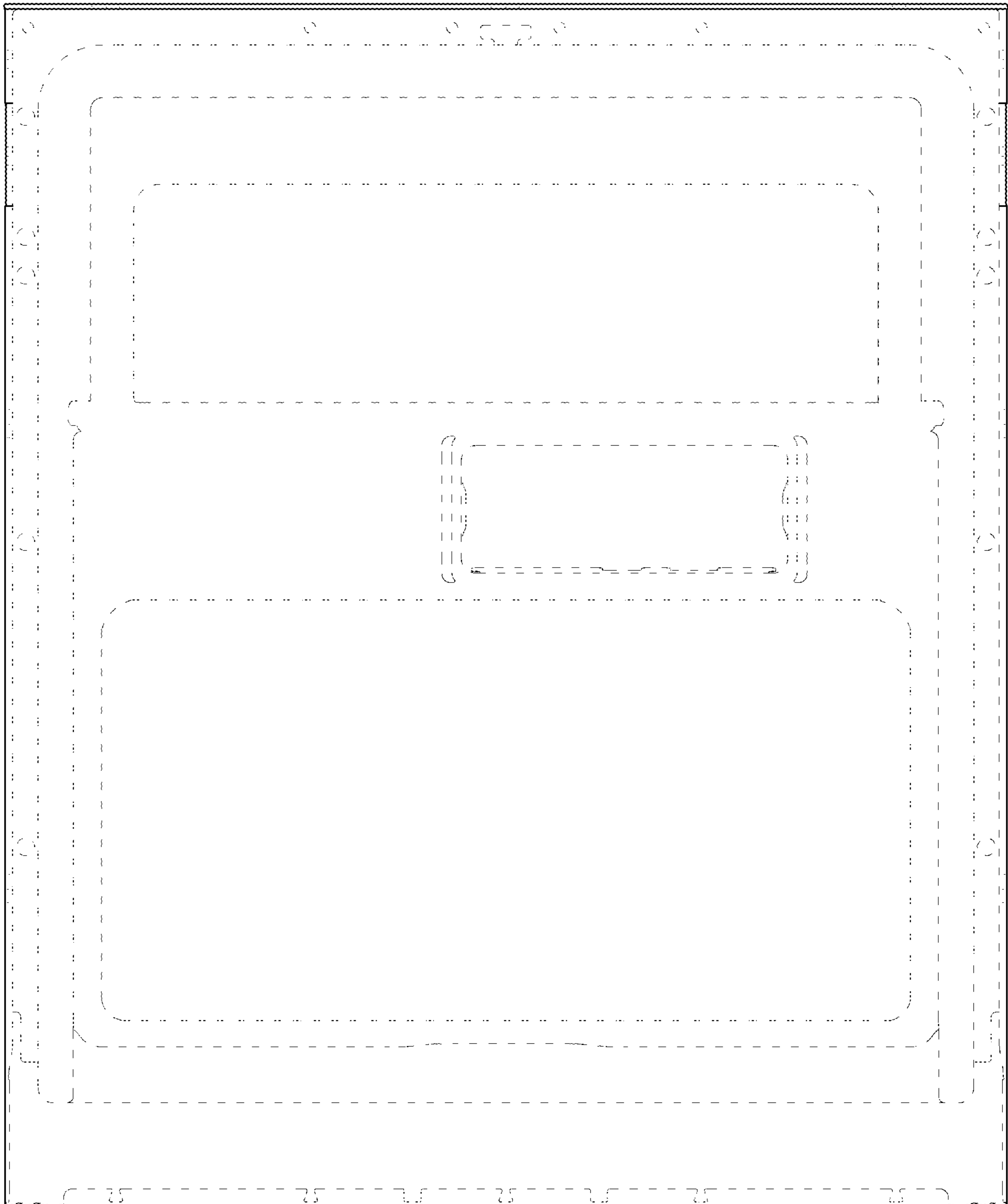

FIG. 22

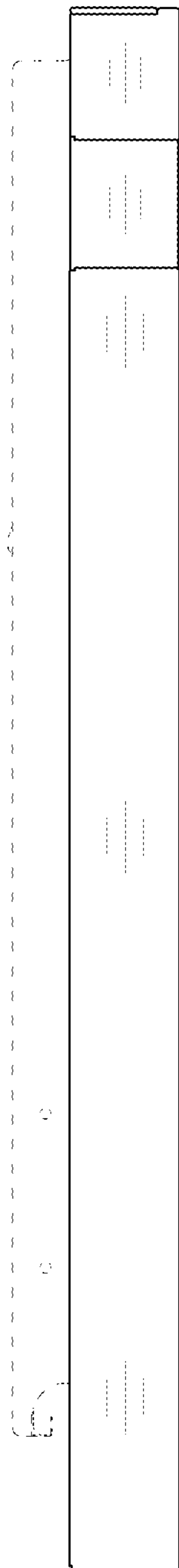

FIG. 23

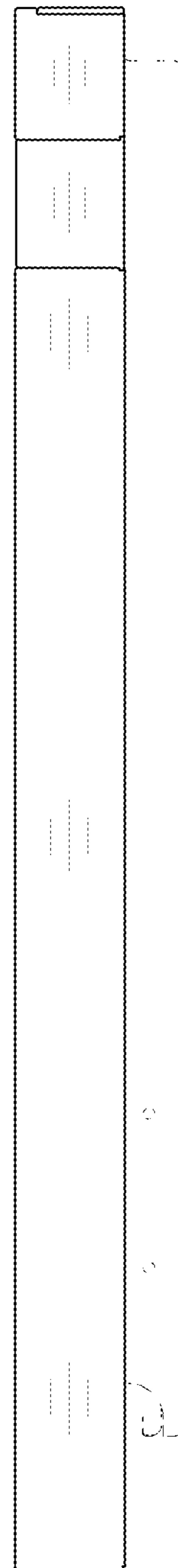

FIG. 24

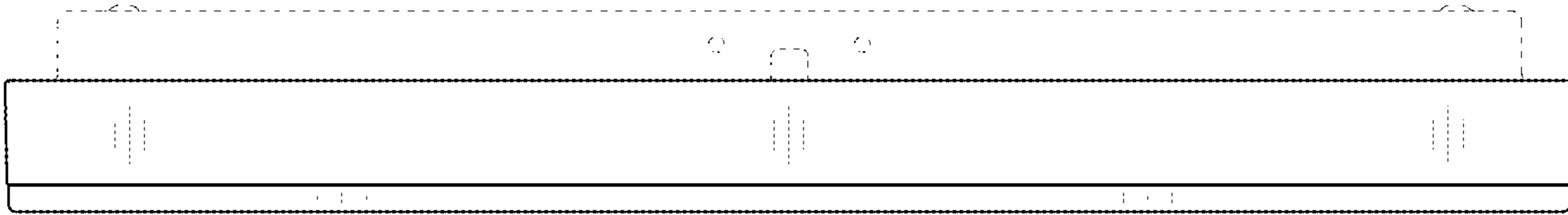

FIG. 25

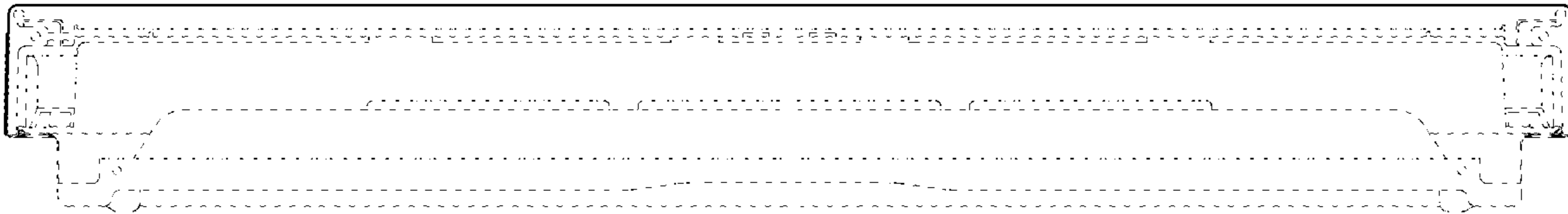

FIG. 26

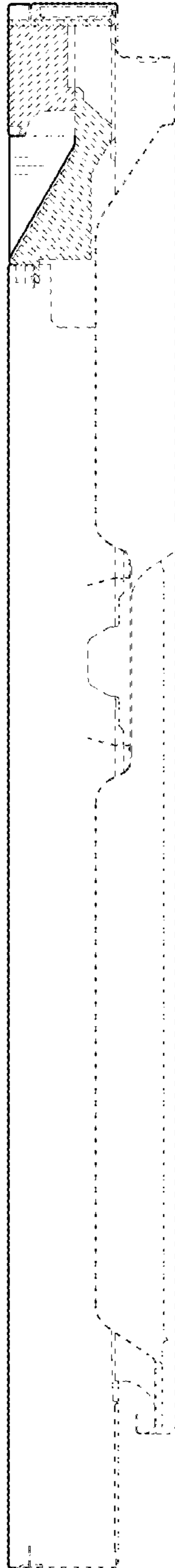

FIG. 27

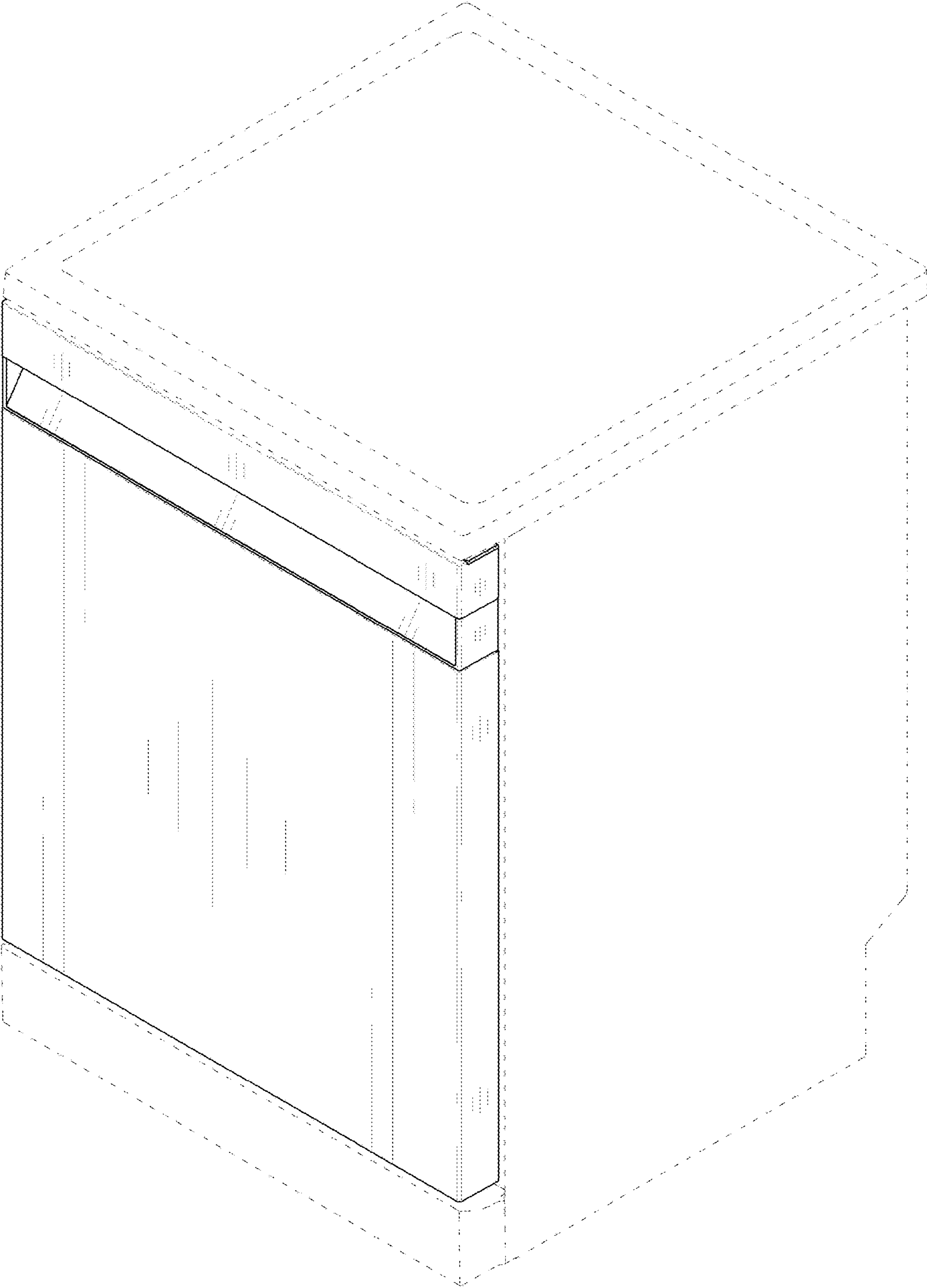

FIG. 28

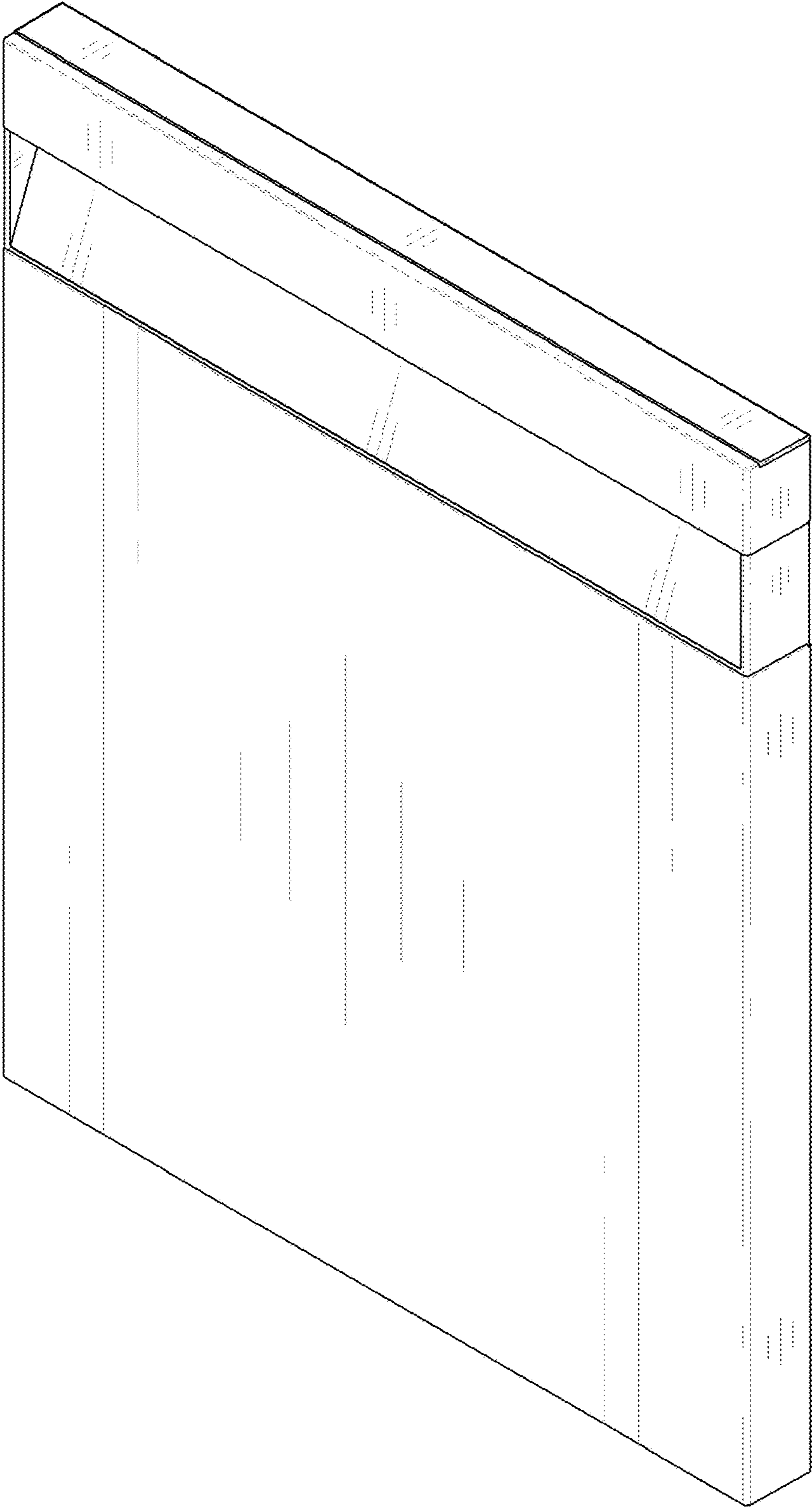

FIG. 29

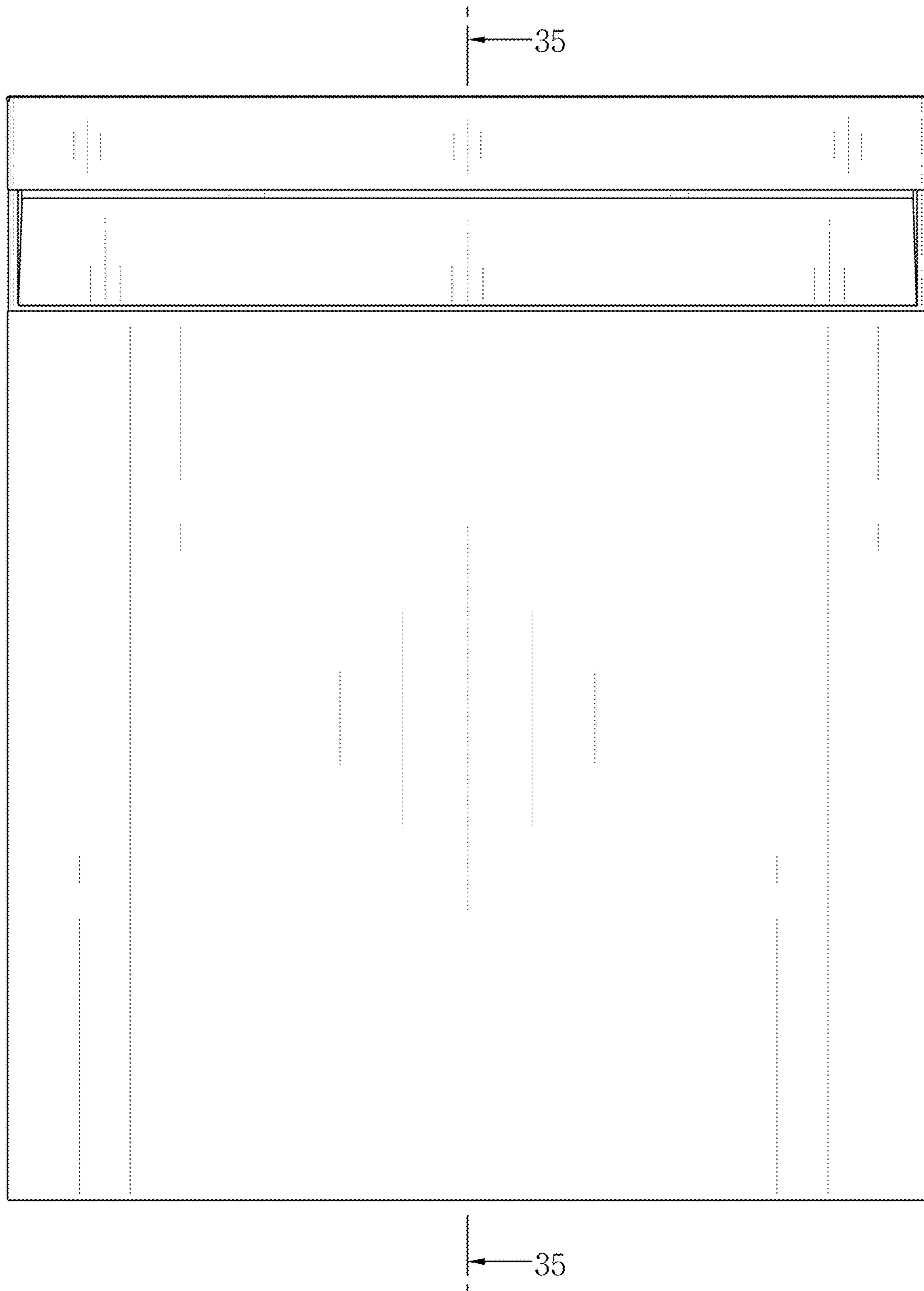

FIG. 30

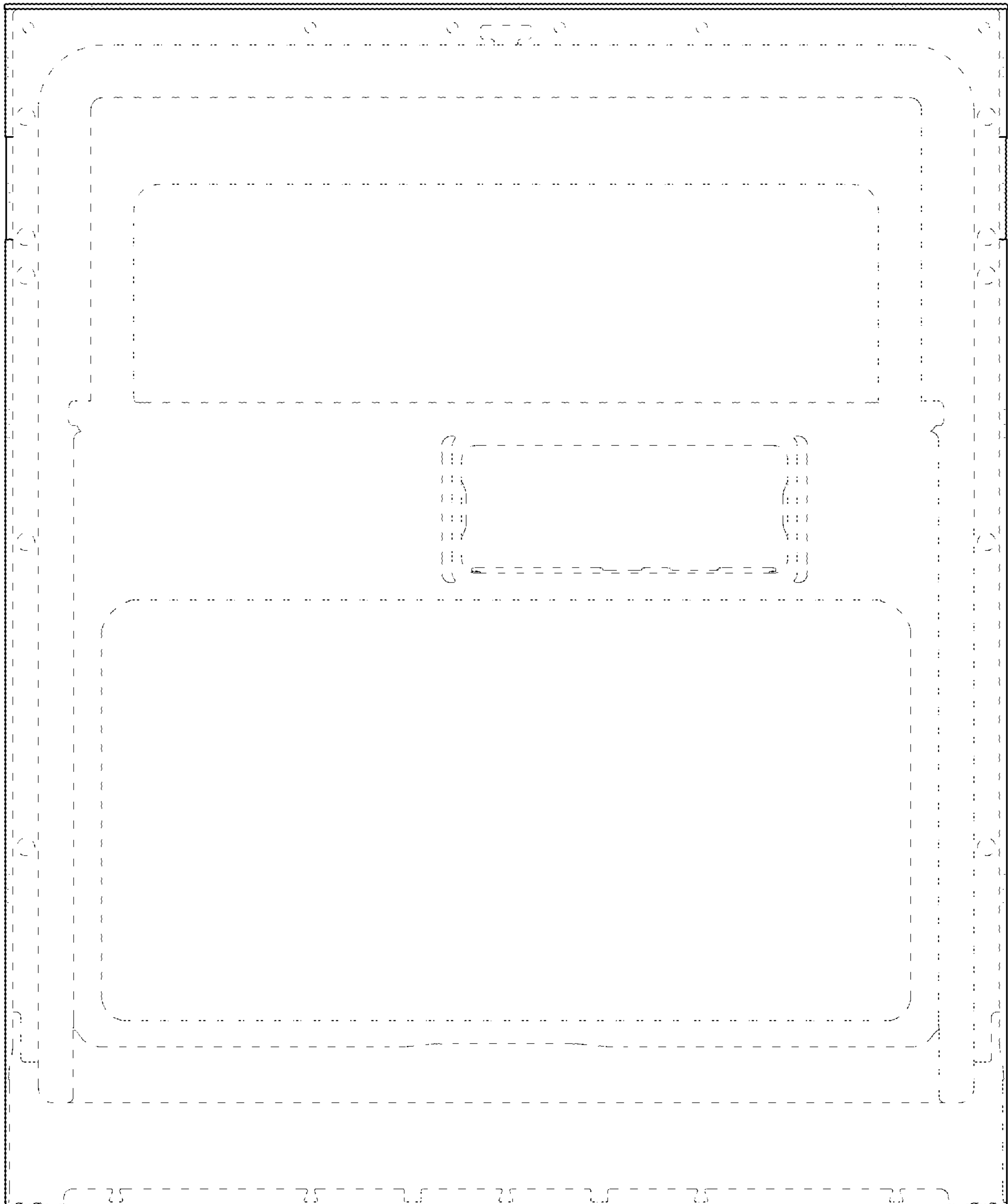

FIG. 31

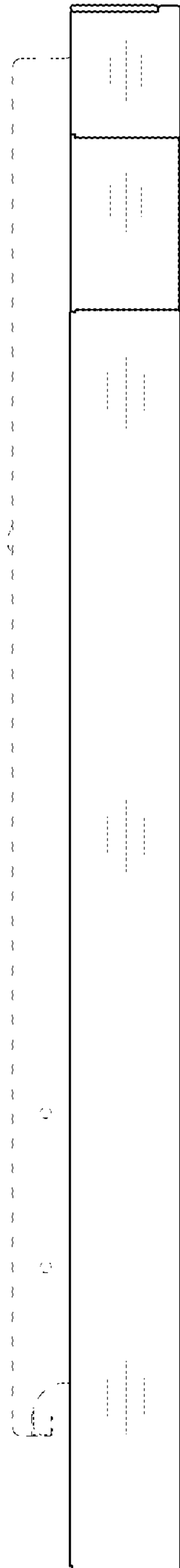

FIG. 32

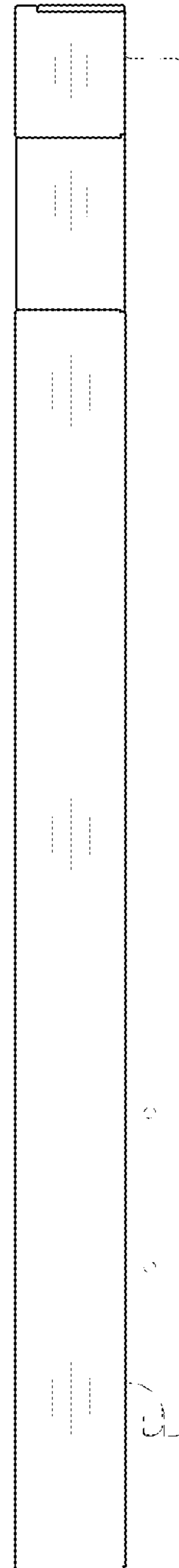

FIG. 33

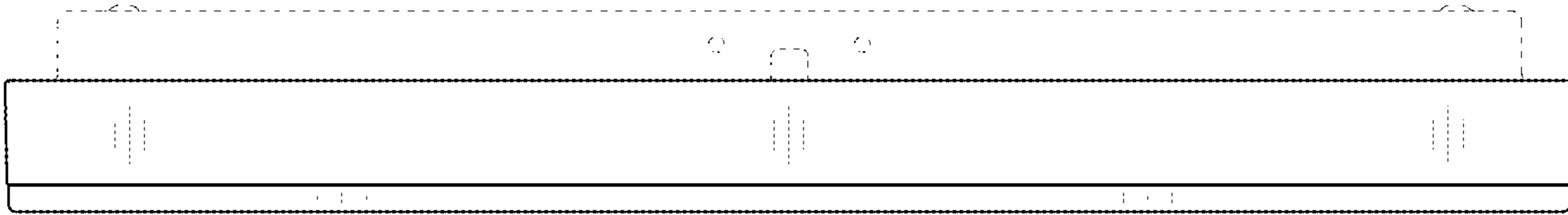

FIG. 34

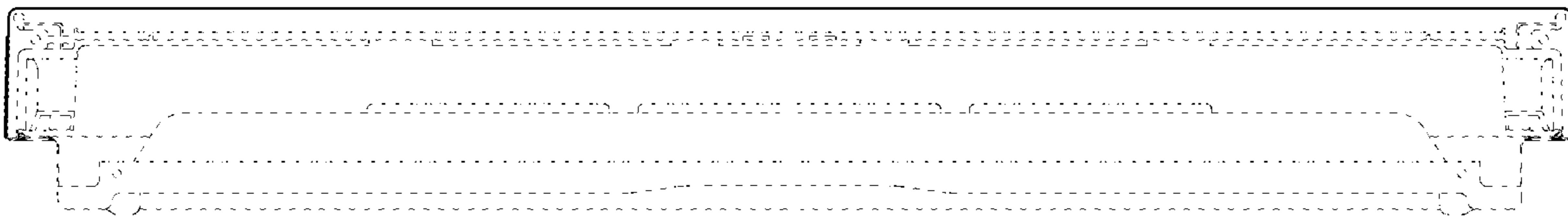

FIG. 35

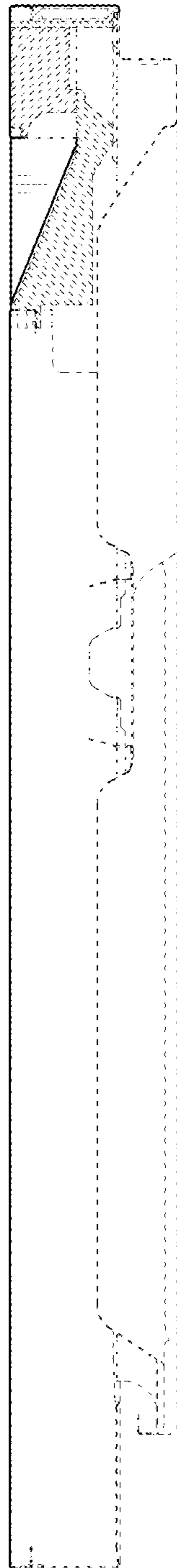

FIG. 36

