



US00D885661S

(12) **United States Design Patent**
Kan

(10) **Patent No.:** **US D885,661 S**

(45) **Date of Patent:** **** May 26, 2020**

(54) **HAIR DRYER WITH HAIR IRON**
(71) Applicant: **Lumielina International Inc.**, Chuo-ku
Tokyo (JP)

(72) Inventor: **Satoshi Kan**, Chuo-ku Tokyo (JP)

(73) Assignee: **LUMIELINA INTERNATIONAL
INC.**, Tokyo (JP)

(**) Term: **15 Years**

(21) Appl. No.: **29/654,642**

(22) Filed: **Jun. 26, 2018**

(30) **Foreign Application Priority Data**

Dec. 26, 2017 (JP) D2017-029120

(51) **LOC (12) Cl.** **28-03**

(52) **U.S. Cl.**
USPC **D28/13**

(58) **Field of Classification Search**
USPC D28/12-18, 35
CPC A45D 20/00; A45D 20/48; A45D 20/50;
A45D 20/52; A45D 20/525
See application file for complete search history.

(56) **References Cited**

U.S. PATENT DOCUMENTS

D294,743 S * 3/1988 Seki D28/35
D300,065 S * 2/1989 Zaborowski D28/18

D317,366 S * 6/1991 Chui D28/35
D318,933 S * 8/1991 Chui D28/35
D384,439 S * 9/1997 Howard D28/35
D410,766 S * 6/1999 Rizzuto D28/35
D556,948 S * 12/2007 Leung D28/35

* cited by examiner

Primary Examiner — Zenia I Bennett

(74) *Attorney, Agent, or Firm* — Cantor Colburn LLP

(57) **CLAIM**

The ornamental design for an hair dryer with hair iron, as shown and described.

DESCRIPTION

FIG. 1 is a perspective view of the hair dryer with hair iron
FIG. 2 is a perspective view of body of FIG. 1;
FIG. 3 is a front view of FIG. 1;
FIG. 4 is a rear view of FIG. 1;
FIG. 5 is a left side view of FIG. 1;
FIG. 6 is a right side view of FIG. 1;
FIG. 7 is a plan view of FIG. 1;
FIG. 8 is a bottom view of FIG. 1;
FIG. 9 is a front view of body of FIG. 1;
FIG. 10 is a rear view of body of FIG. 1;
FIG. 11 is a left side view of body of FIG. 1;
FIG. 12 is a right side view of body of FIG. 1;
FIG. 13 is a plan view of body of FIG. 1; and,
FIG. 14 is a reference diagram showing name of each
element of FIG. 1.

The broken lines in the drawings are for the purpose of illustrating portions of the hair dryer with hair iron that form no part of the claimed design.

1 Claim, 7 Drawing Sheets

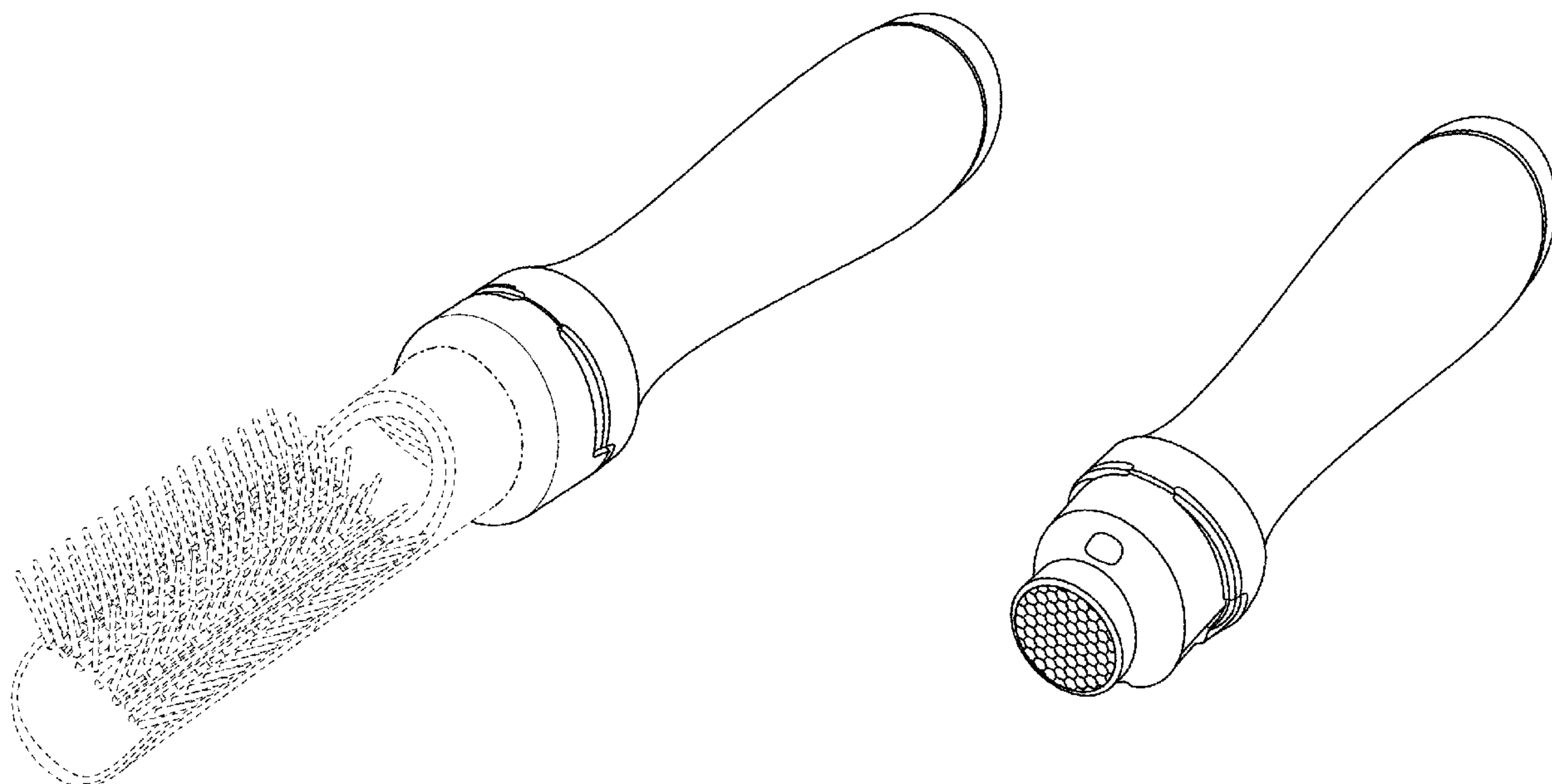

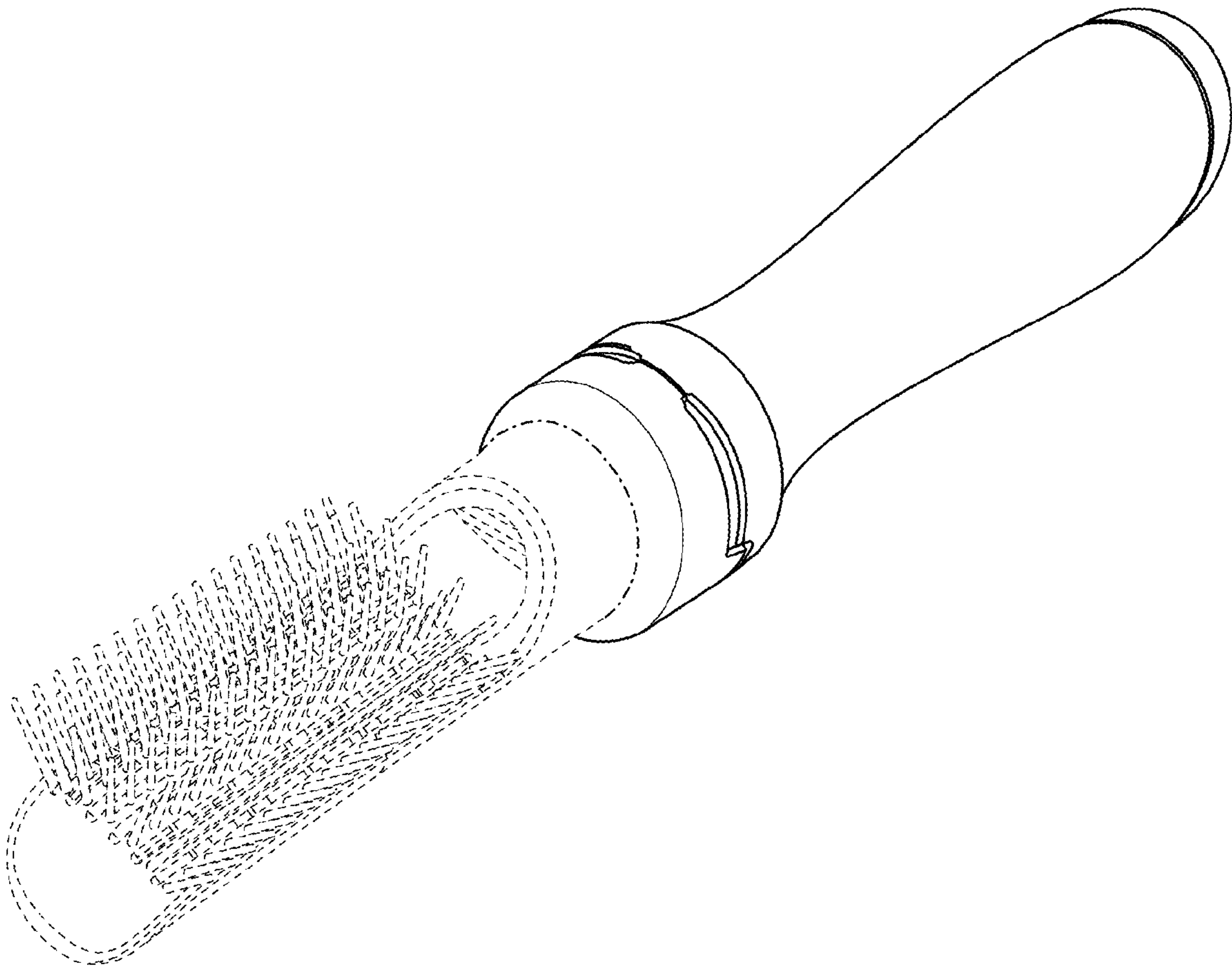

FIG. 1



FIG. 2

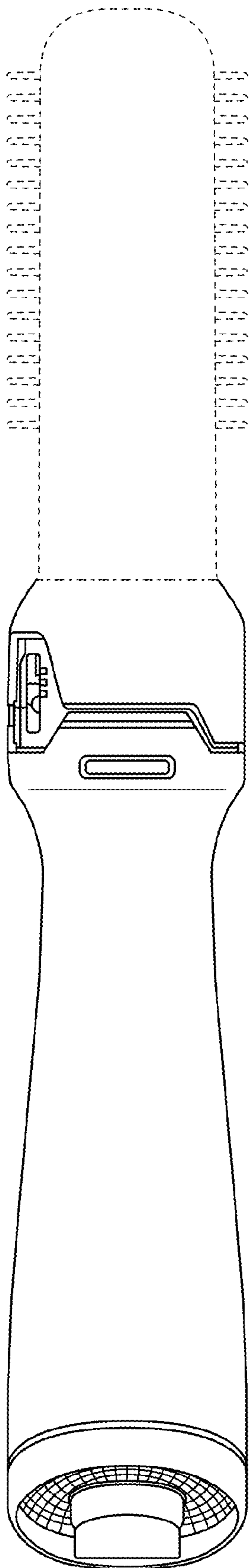

FIG. 3

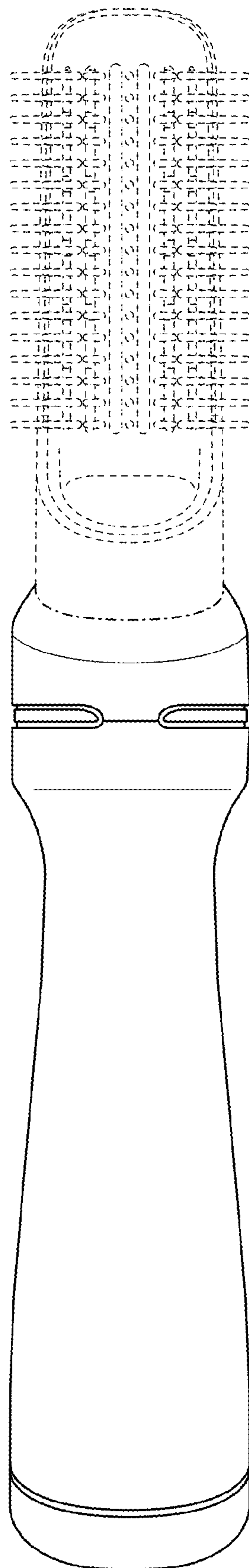

FIG. 4

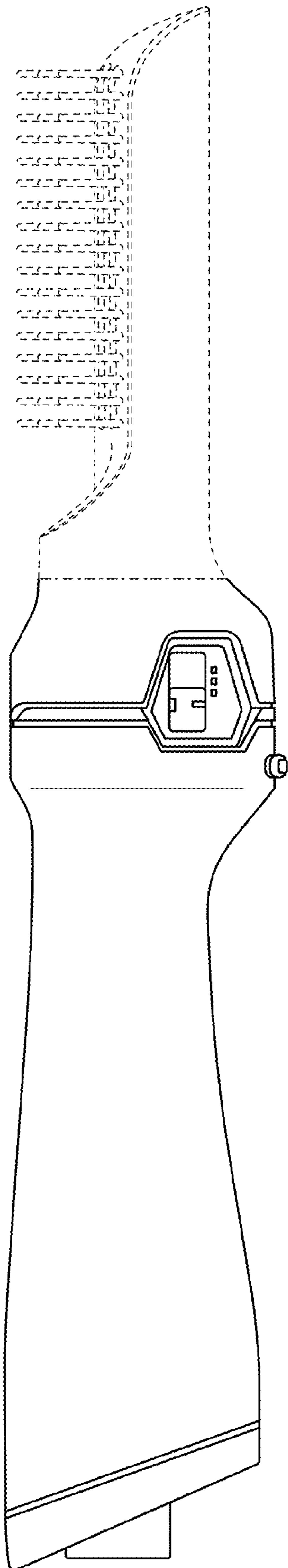

FIG. 5

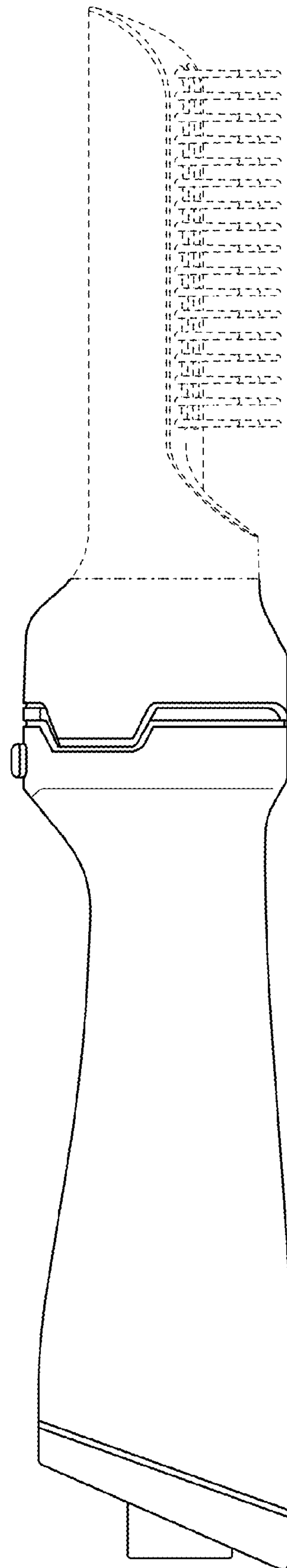

FIG. 6

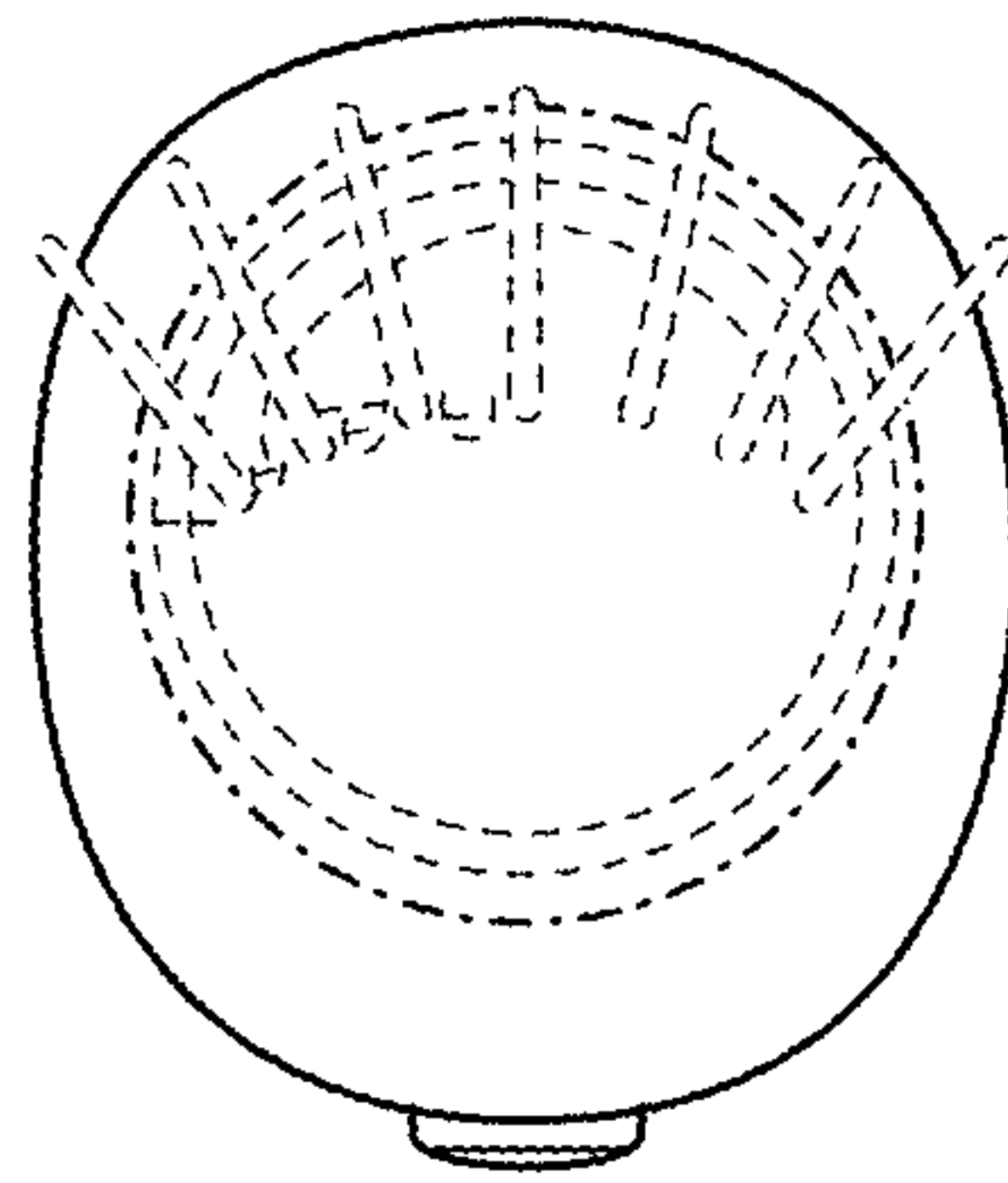

FIG. 7

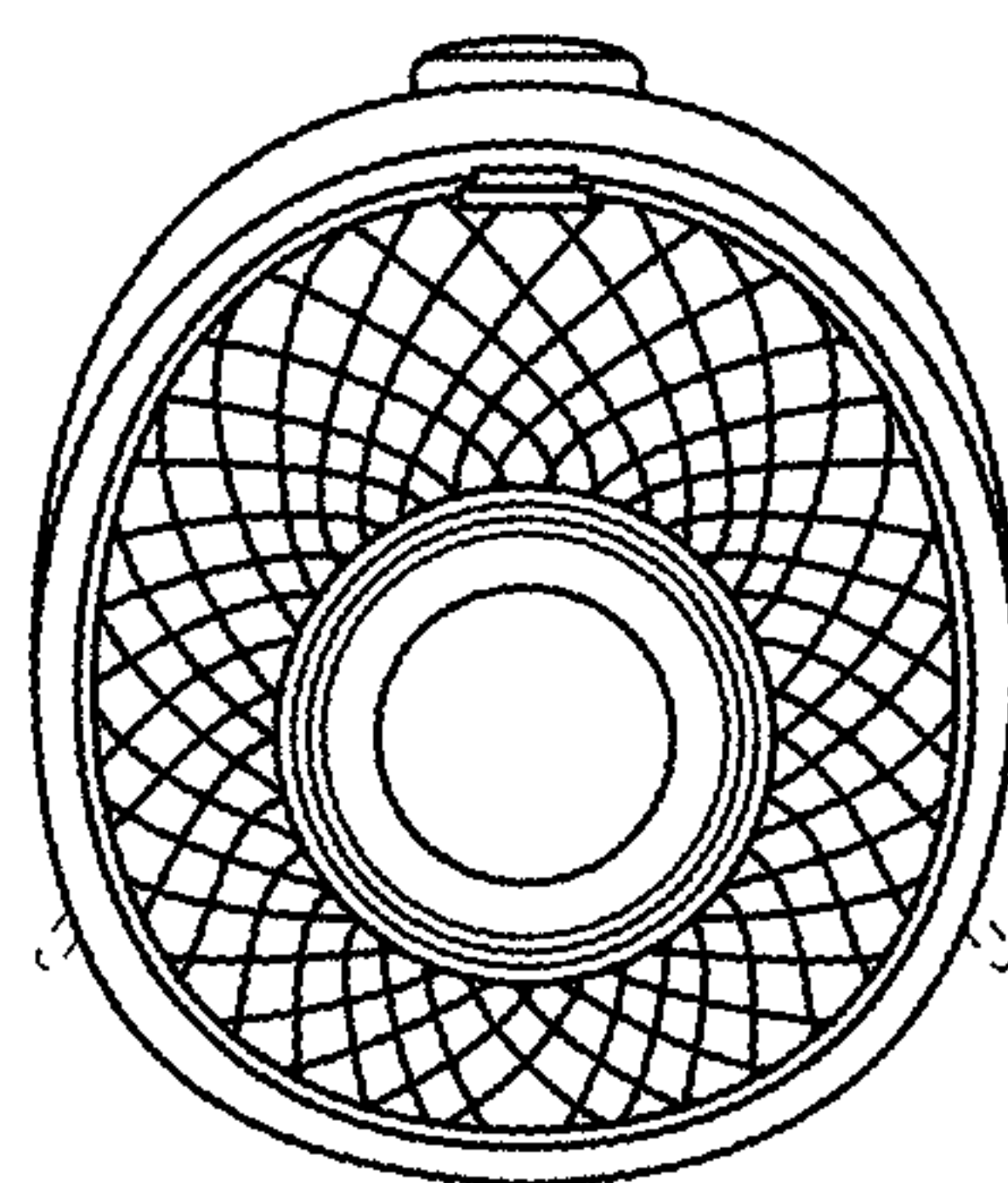

FIG. 8

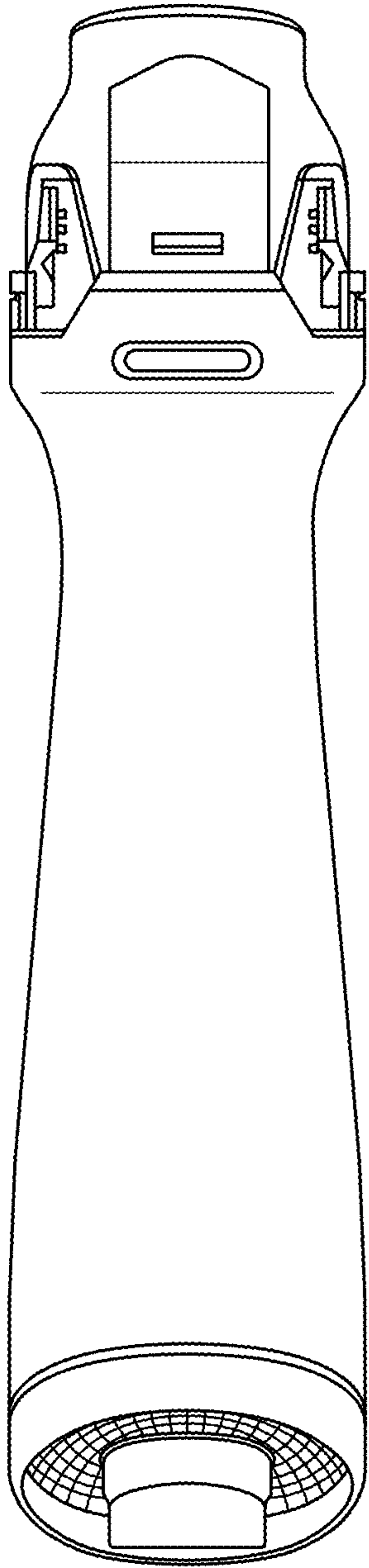

FIG. 9

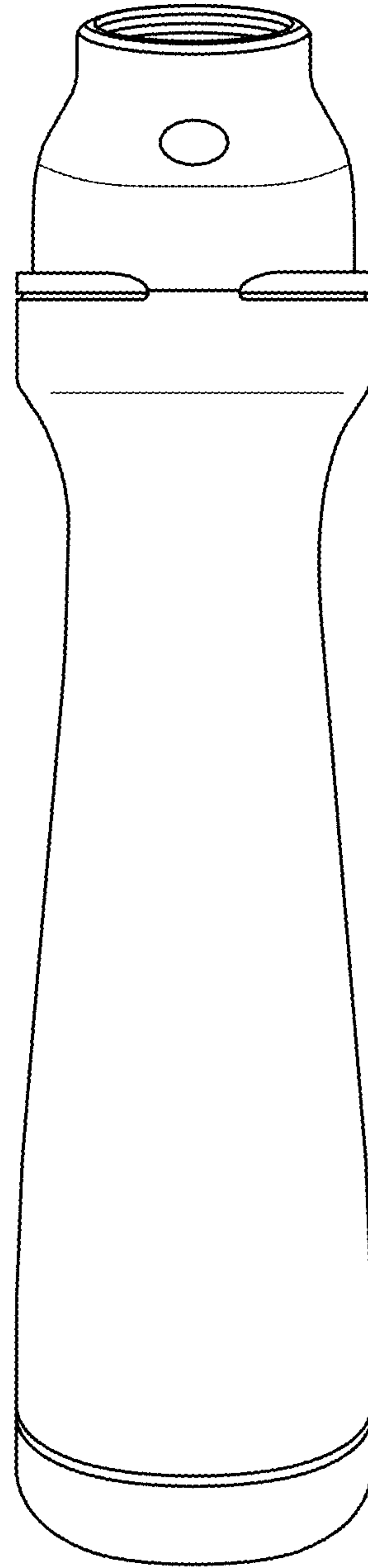

FIG. 10

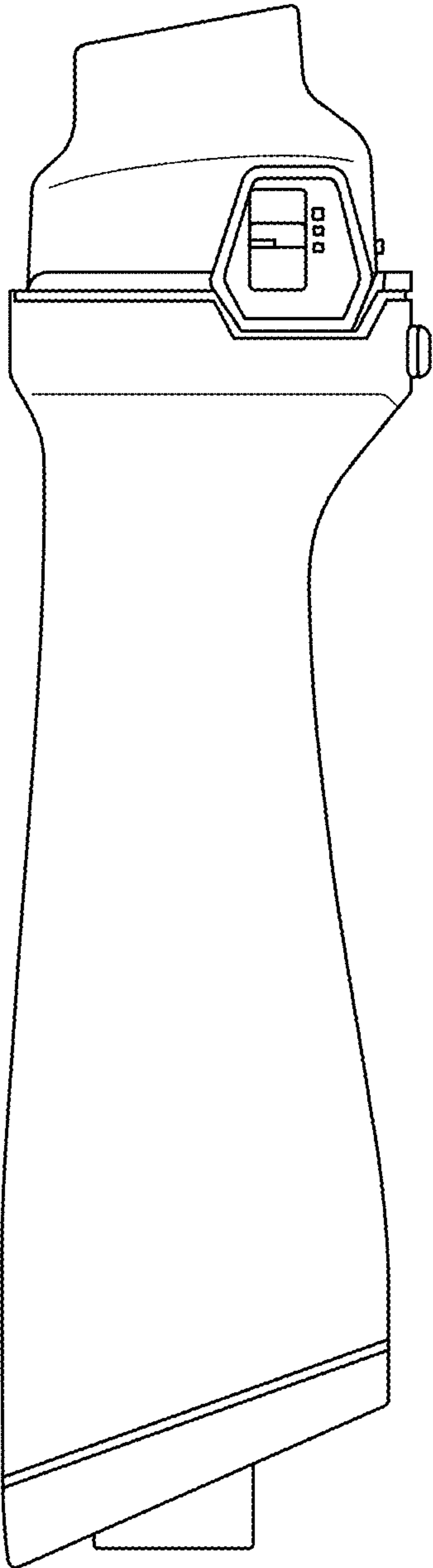

FIG. 11

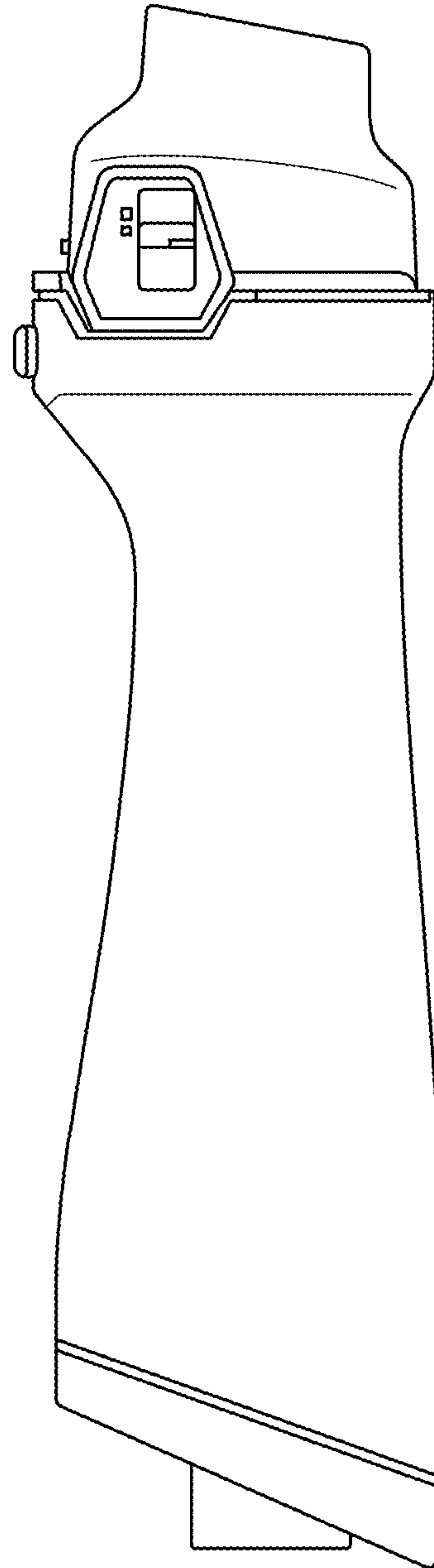

FIG. 12

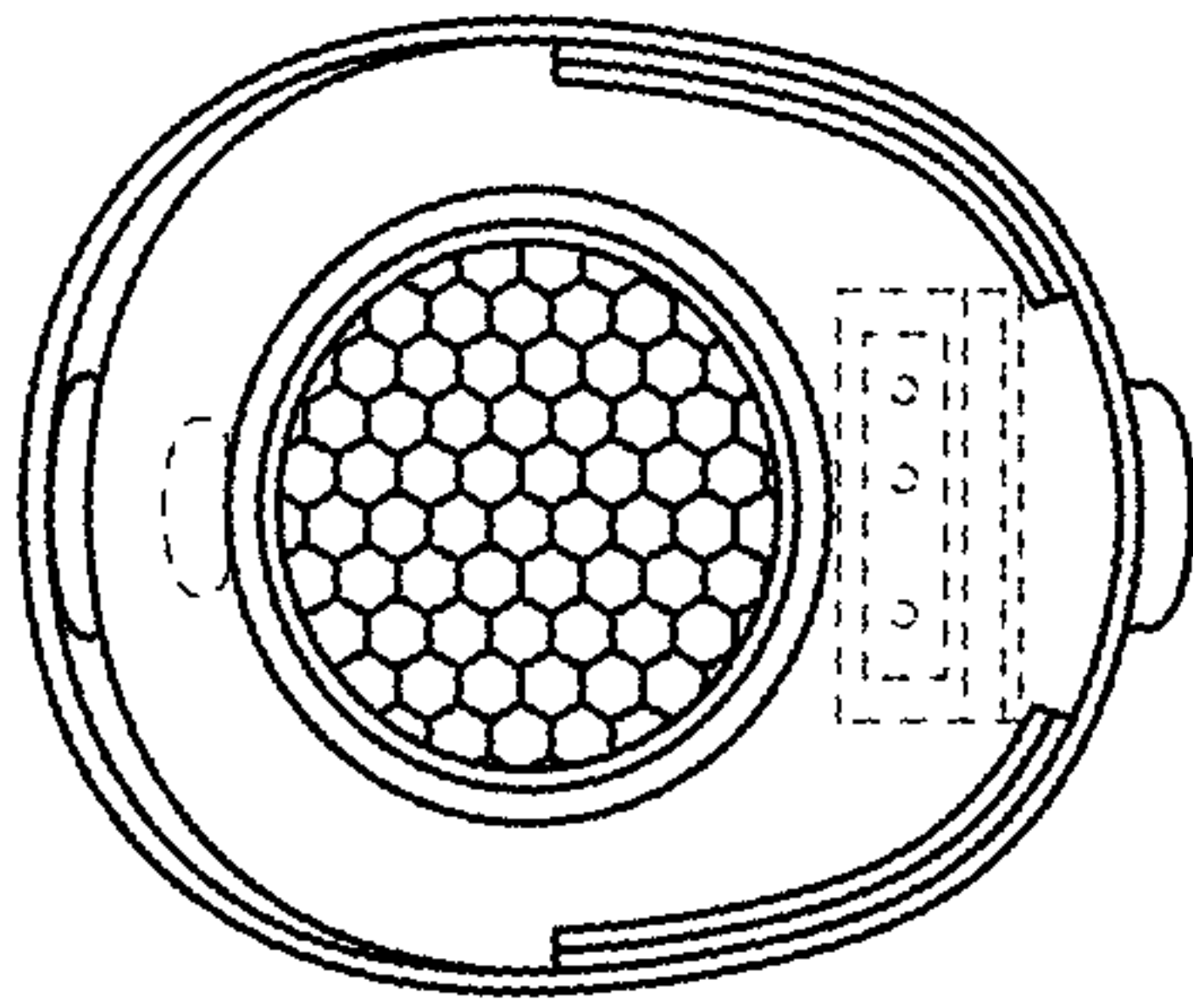

FIG. 13

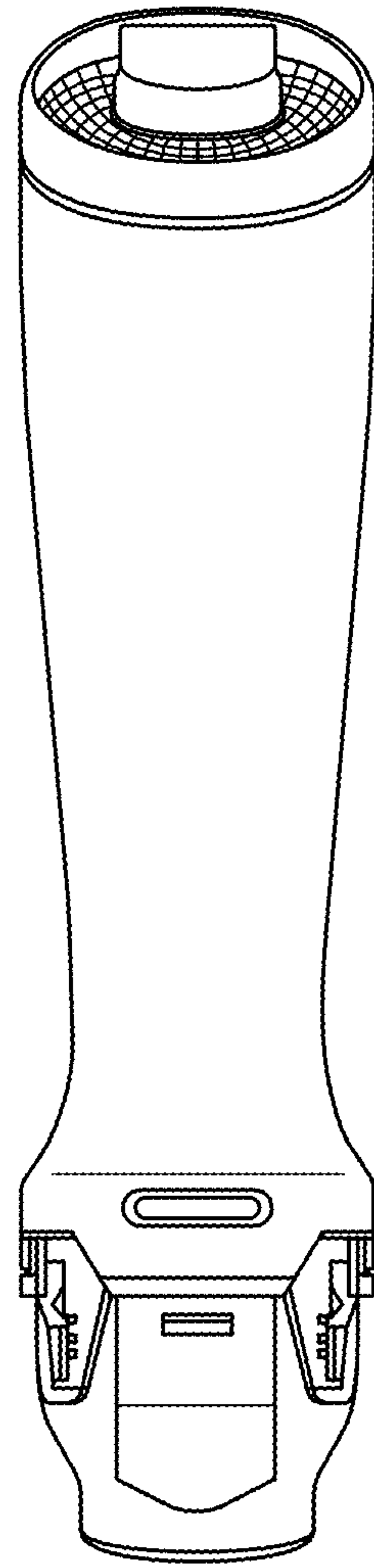

FIG. 14

