



US00D885655S

(12) **United States Design Patent**
Ding

(10) **Patent No.:** **US D885,655 S**

(45) **Date of Patent:** **** May 26, 2020**

(54) **ELECTRONIC CIGARETTE**

(71) Applicant: **ALD GROUP LIMITED**, Shenzhen,
Guangdong Province (CN)

(72) Inventor: **Yi Ding**, Shenzhen (CN)

(**) Term: **15 Years**

(21) Appl. No.: **29/672,177**

(22) Filed: **Dec. 4, 2018**

(30) **Foreign Application Priority Data**

Aug. 10, 2018 (CN) 2018 3 0440937

(51) **LOC (12) Cl.** **27-02**

(52) **U.S. Cl.**
USPC **D27/162**

(58) **Field of Classification Search**

USPC D27/162, 100, 101, 163–165, 172, 183,
D27/185–194; D24/110, 110.5; 131/273,
131/270, 191, 329, 330, 360–365;
128/202.21, 203.12

CPC A24F 47/002; A24F 47/004; A24F 47/006;
A24F 47/008; A61M 15/00; A61M 15/06

See application file for complete search history.

(56) **References Cited**

U.S. PATENT DOCUMENTS

D750,320 S * 2/2016 Verleur A24F 47/008
D27/101

D792,643 S * 7/2017 Wong D27/101

D799,110 S * 10/2017 Qiu D27/101
D799,113 S * 10/2017 Qiu D27/101
D799,744 S * 10/2017 Qiu D27/101
D832,499 S * 10/2018 Qiu D27/162
D834,246 S * 11/2018 Qiu D27/162
D837,446 S * 1/2019 Durand D27/101
D843,644 S * 3/2019 Qiu D27/101
D851,827 S * 6/2019 Clark D27/162
D859,735 S * 9/2019 Qiu D27/162
D860,517 S * 9/2019 Qiu D27/101

* cited by examiner

Primary Examiner — Marissa J Cash

Assistant Examiner — Rebecca Tsehaye

(74) *Attorney, Agent, or Firm* — HYIP

(57) **CLAIM**

The ornamental design for an electronic cigarette, as shown and described.

DESCRIPTION

FIG. 1 is a perspective view of an electronic cigarette showing my new design;

FIG. 2 is another perspective view thereof;

FIG. 3 is a front view thereof;

FIG. 4 is a rear view thereof;

FIG. 5 is a left side view thereof;

FIG. 6 is a right side view thereof;

FIG. 7 is a top view thereof; and,

FIG. 8 is a bottom view thereof.

The broken lines depict portions of the electronic cigarette that form no part of the claimed design.

1 Claim, 8 Drawing Sheets

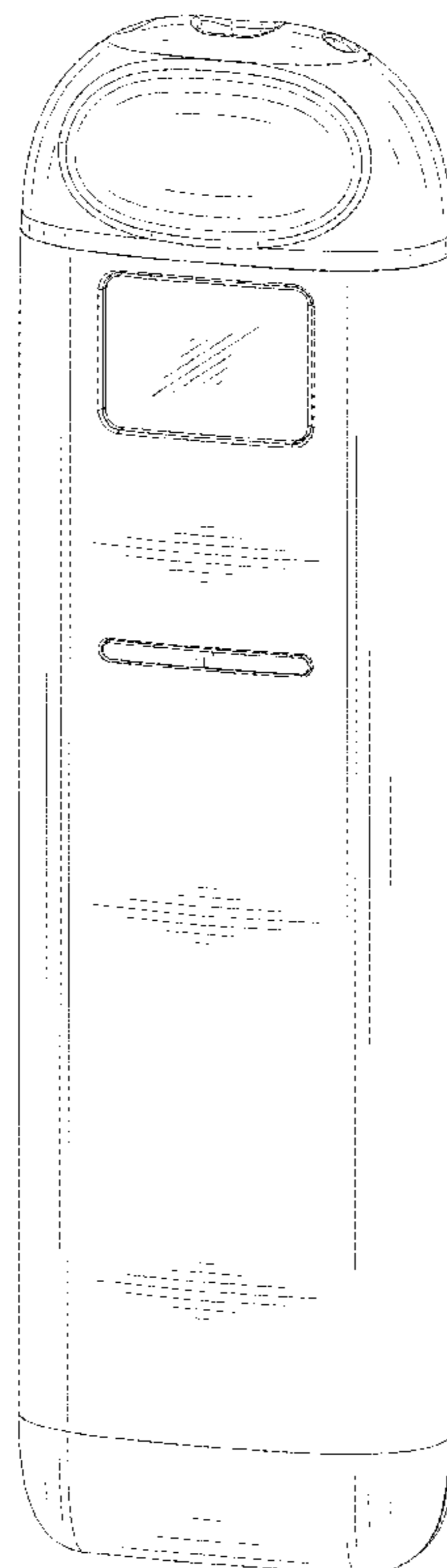

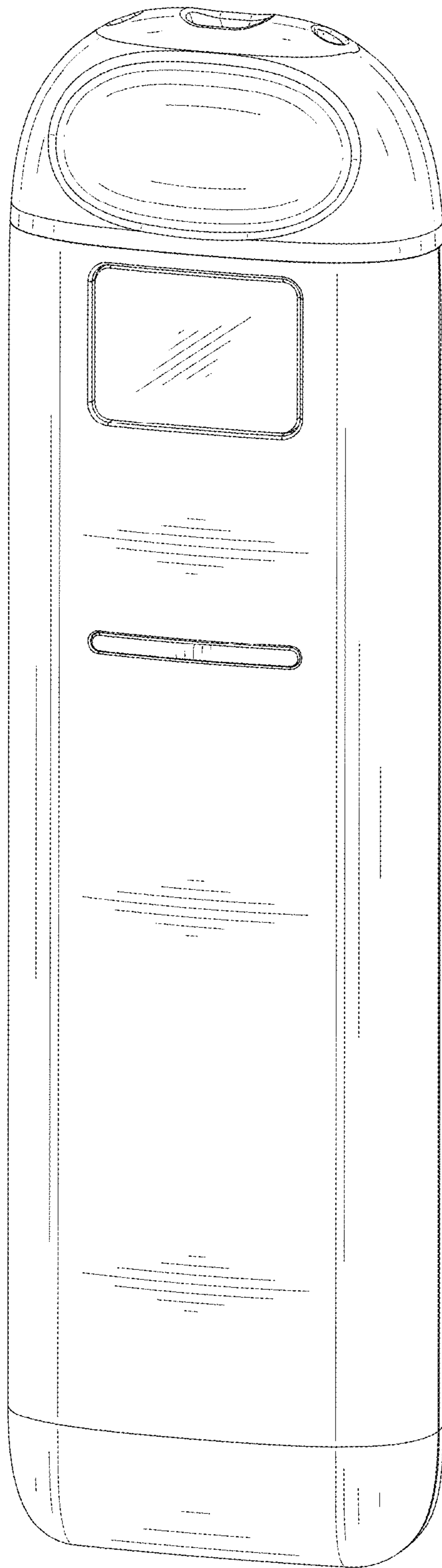

FIG.1

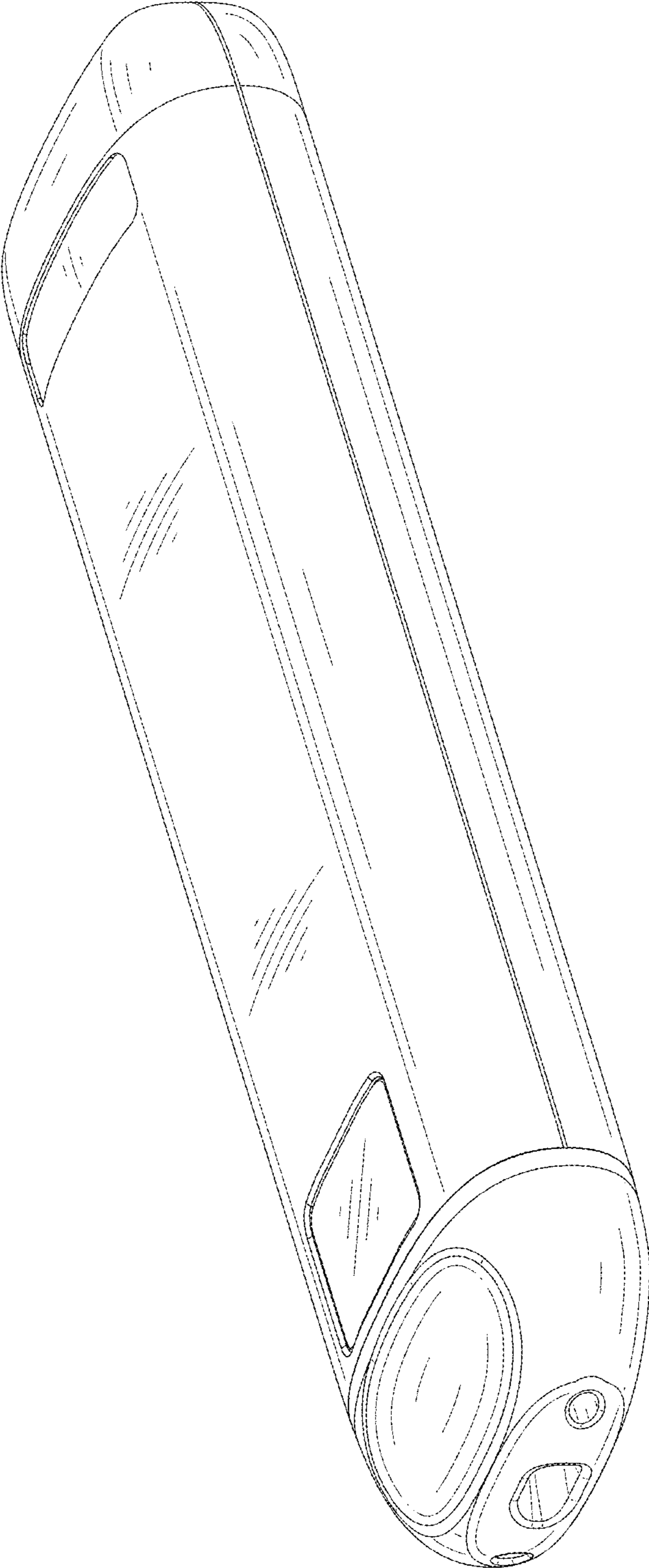

FIG.2

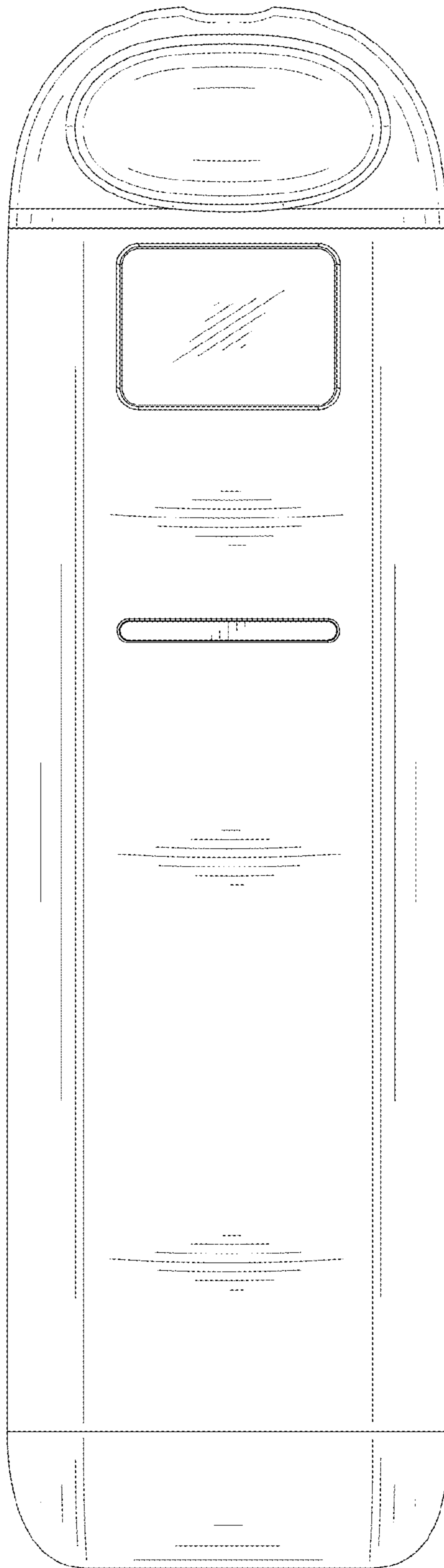

FIG.3

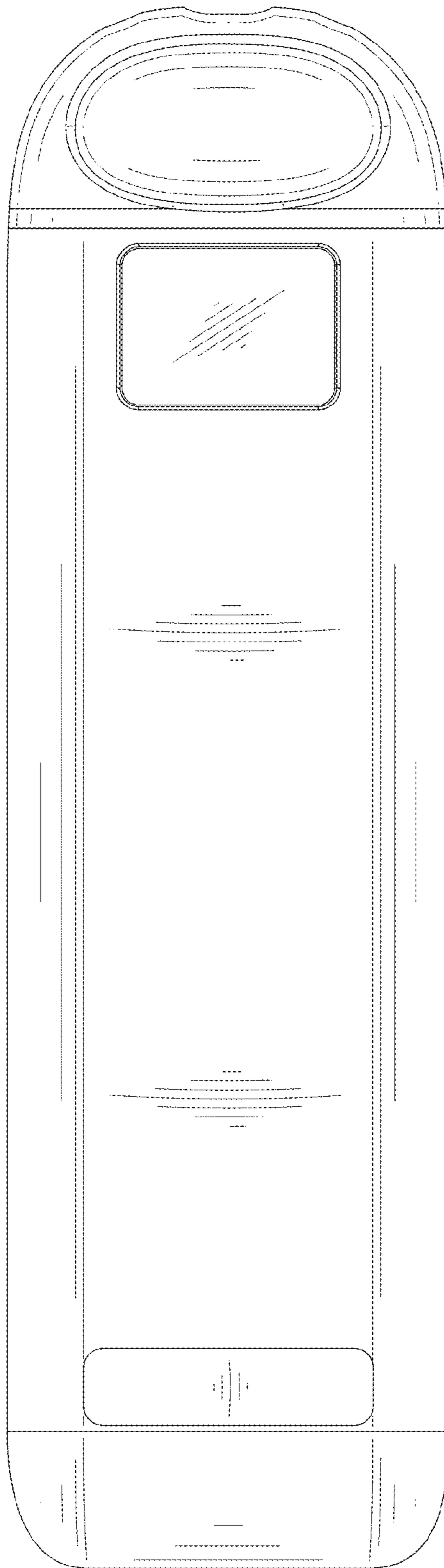

FIG.4

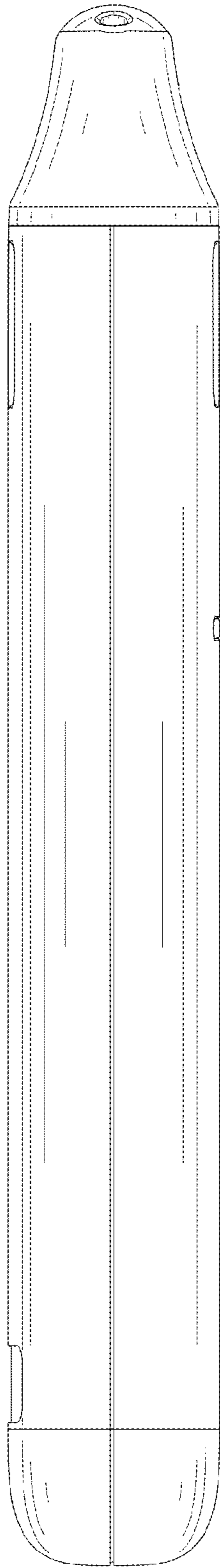

FIG.5

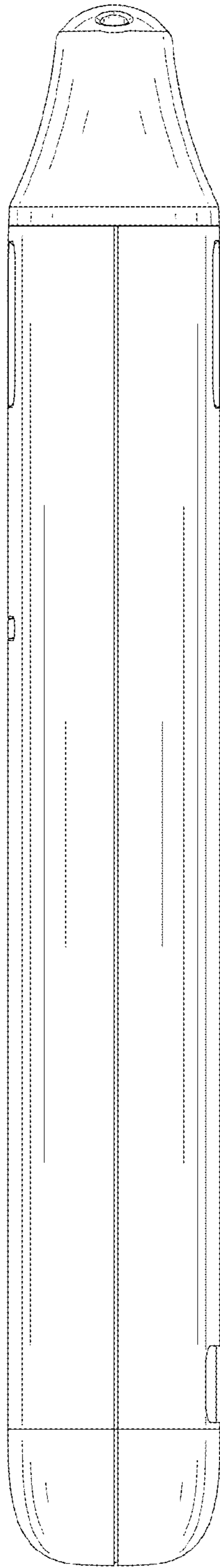

FIG.6

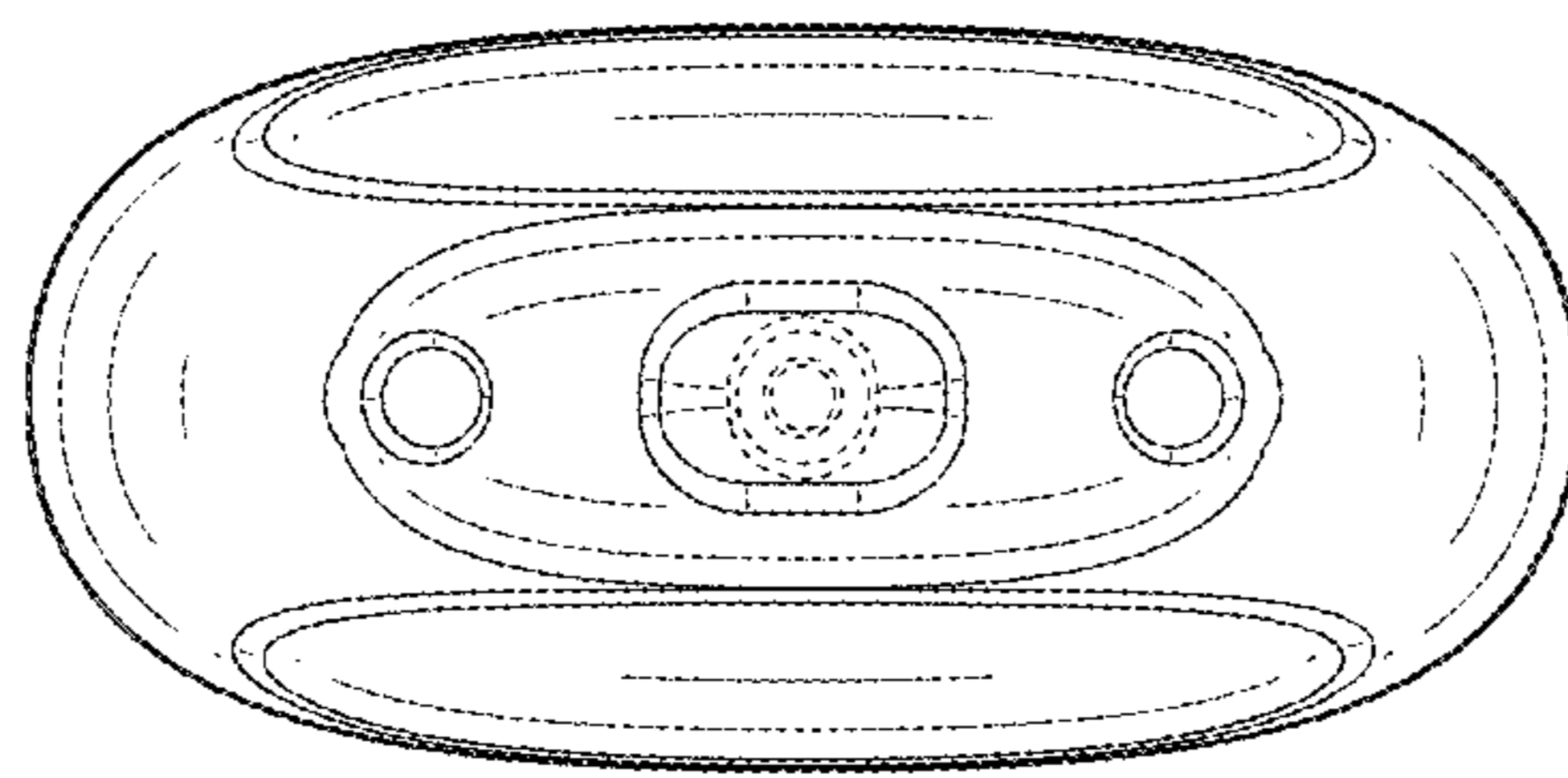

FIG.7

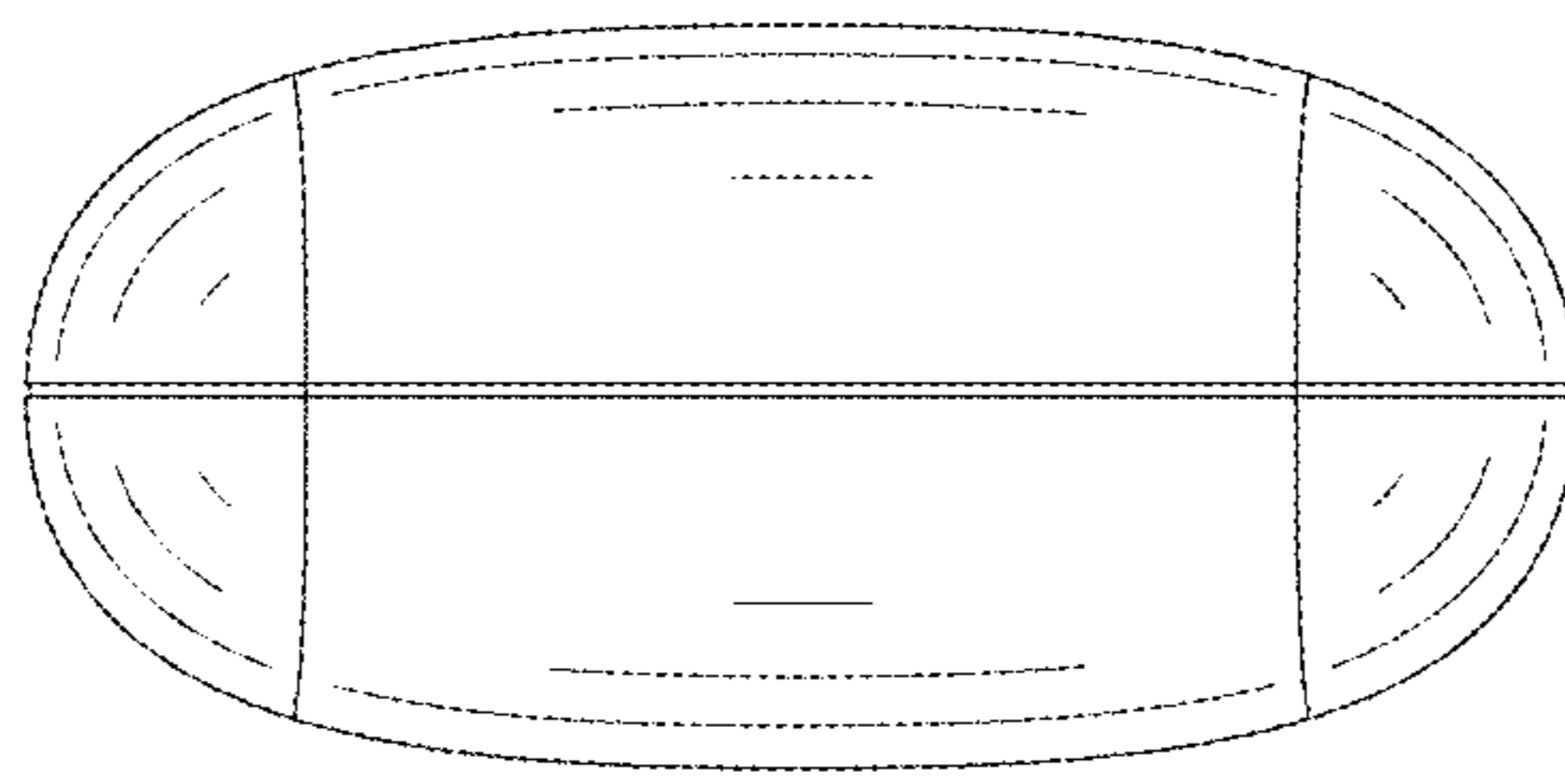

FIG. 8