



US00D885605S

(12) **United States Design Patent** (10) **Patent No.:** **US D885,605 S**
Johns et al. (45) **Date of Patent:** **** May 26, 2020**

(54) **SAMPLE TUBE RACK**

FOREIGN PATENT DOCUMENTS

(71) Applicant: **Beckman Coulter, Inc.**, Brea, CA (US)

CN 2810594 8/2006
CN 2810594 Y 8/2006

(72) Inventors: **Charles W. Johns**, Brownsburg, IN (US); **Thomas Krafczyk**, Olching (DE)

(Continued)

(73) Assignee: **Beckman Coulter, Inc.**, Brea, CA (US)

OTHER PUBLICATIONS

(**) Term: **15 Years**

U.S. Appl. No. 29/572,596, filed Jul. 28, 2016.

(21) Appl. No.: **29/683,165**

(Continued)

(22) Filed: **Mar. 11, 2019**

Primary Examiner — Susan Bennett Hattan

Assistant Examiner — Rebecca Tsehaye

(74) *Attorney, Agent, or Firm* — Schwegman Lundberg & Woessner, P.A.

Related U.S. Application Data

(63) Continuation of application No. 29/639,293, filed on Mar. 5, 2018, now Pat. No. Des. 843,014, which is a continuation of application No. 29/572,596, filed on Jul. 28, 2016, now Pat. No. Des. 812,243.

(57) **CLAIM**

(51) **LOC (12) Cl.** **24-02**

The ornamental design for sample tube rack, as shown and described.

(52) **U.S. Cl.**
USPC **D24/227**

(58) **Field of Classification Search**
USPC D24/224–230, 216, 217, 232; 422/569, 422/500–553, 560–562, 50, 400; 211/126.1, 74, 70.1; 435/287.1, 288, 4, 435/305.2, 289.1; 206/443
CPC . B65D 25/108; B01L 9/00; B01L 9/06; B01L 9/065; B01L 9/543
See application file for complete search history.

DESCRIPTION

FIG. 1 is a perspective view of sample tube rack showing my new design;
FIG. 2 is a front elevational view;
FIG. 3 is a rear side elevational view;
FIG. 4 is a right elevational view;
FIG. 5 is a left side elevational view;
FIG. 6 is a top plan view;
FIG. 7 is a bottom plan view; and,
FIG. 8 is an exploded view.
The broken lines consisting of equal length dash lines in the drawings depict parts of the sample tube rack that form no part of the claimed design. The broken lines consisting of long and short dashed lines in the drawings depict boundaries of the claimed design, and it is understood that the claim extends to the boundaries that form no part of the claimed design.

(56) **References Cited**

U.S. PATENT DOCUMENTS

3,604,566 A 9/1971 Rem et al.
4,090,850 A 5/1978 Chen
4,284,603 A 8/1981 Korom
D265,126 S 6/1982 Beall
D302,207 S 7/1989 Matkovich
5,080,232 A 1/1992 Leoncavallo et al.
5,128,105 A 7/1992 Berthold et al.
5,169,603 A 12/1992 Landsberger

(Continued)

1 Claim, 8 Drawing Sheets

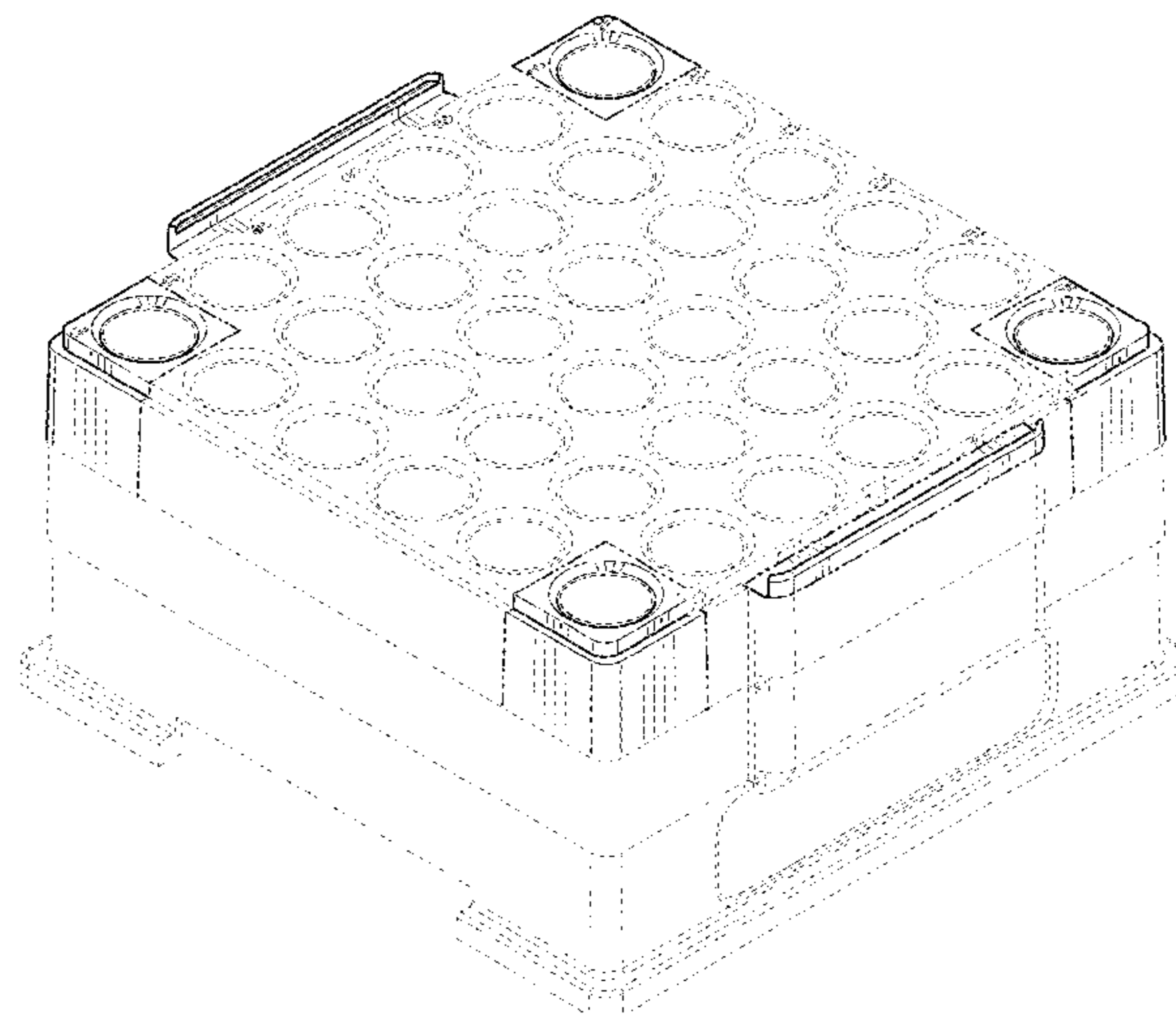

(56)

References Cited

U.S. PATENT DOCUMENTS

5,318,753 A 6/1994 Honda
 5,456,360 A 10/1995 Griffin et al.
 5,579,929 A 12/1996 Schwartz
 5,651,941 A 7/1997 Stark et al.
 D382,346 S 8/1997 Buhler et al.
 5,687,849 A 11/1997 Borenstein et al.
 5,785,927 A 7/1998 Scott et al.
 5,902,549 A 5/1999 Tadashi et al.
 D413,391 S 8/1999 Lapeus et al.
 5,939,024 A 8/1999 Robertson
 D414,271 S 9/1999 Mendoza
 5,996,818 A 12/1999 Boje et al.
 D420,743 S * 2/2000 Monks D24/224
 D428,497 S 7/2000 Lapeus et al.
 6,132,684 A 10/2000 Marino
 6,190,619 B1 2/2001 Kilcoin et al.
 D448,854 S 10/2001 Kuiper et al.
 D461,554 S 8/2002 Lafond et al.
 D466,219 S 11/2002 Wynschenk et al.
 6,533,133 B2 3/2003 Liu et al.
 6,568,544 B1 5/2003 Lafond et al.
 6,932,942 B2 8/2005 Itoh et al.
 7,000,785 B2 2/2006 Jafari et al.
 7,122,158 B2 10/2006 Itoh et al.
 7,169,361 B2 1/2007 Arnold, Jr. et al.
 7,191,904 B2 3/2007 Wescott, et al.
 7,282,182 B2 10/2007 Dale et al.
 D595,420 S 6/2009 Suzuki et al.
 D596,312 S 7/2009 Giraud et al.
 7,611,675 B2 11/2009 Sevigny et al.
 D622,860 S 8/2010 Karpiloff
 D628,305 S 11/2010 Loewe et al.
 D628,306 S 11/2010 Blanc et al.
 7,824,615 B2 11/2010 Balli et al.
 D632,404 S 2/2011 Karpiloff
 7,910,067 B2 3/2011 Knight et al.
 D639,447 S 6/2011 Karpiloff
 8,312,781 B2 11/2012 Himmelsbach et al.
 D672,881 S 12/2012 Kraihanzel
 D674,507 S 1/2013 Suzuki et al.
 D675,338 S 1/2013 Suzuki et al.
 D675,748 S * 2/2013 Hilligoss D24/230
 D686,749 S 7/2013 Trump
 8,580,195 B2 11/2013 Frey et al.
 D699,371 S * 2/2014 Williams D24/230
 D710,024 S 7/2014 Guo
 8,845,985 B2 9/2014 Herchenbach et al.
 8,940,252 B2 1/2015 Ziegler
 D724,236 S 3/2015 Blaszcak et al.
 D729,404 S 5/2015 McGarr et al.
 9,046,506 B2 6/2015 Müller et al.
 9,144,801 B2 9/2015 Johnson et al.
 9,358,542 B2 6/2016 Xu et al.
 9,423,409 B2 8/2016 Friedman et al.
 D768,870 S * 10/2016 Kuhn D24/224
 9,482,684 B2 11/2016 Otts et al.
 9,505,005 B2 11/2016 Takai et al.
 D774,659 S * 12/2016 Quackenbush D24/216
 9,630,179 B2 4/2017 Knight et al.
 D785,428 S 5/2017 Friesen
 D787,087 S * 5/2017 Duffy D24/227
 9,636,681 B2 5/2017 Ohga et al.
 D808,540 S * 1/2018 Johns D24/227
 D812,243 S * 3/2018 Johns D24/227
 D812,244 S 3/2018 Shanafelter et al.
 9,943,849 B2 4/2018 Johnson et al.
 D825,774 S * 8/2018 Self D24/224
 D827,149 S * 8/2018 Self D24/224
 D832,456 S * 10/2018 Self D24/224
 D838,380 S * 1/2019 Self D24/224
 D840,053 S * 2/2019 Kamees D24/230
 D843,014 S 3/2019 Johns et al.
 D844,806 S 4/2019 Johns et al.
 D849,961 S * 5/2019 Muller D24/224
 D854,707 S * 7/2019 Jakobsen D24/230

2002/0068022 A1 6/2002 Schneider et al.
 2002/0108917 A1 8/2002 Maruyama
 2003/0017084 A1 1/2003 Dale et al.
 2003/0235519 A1 12/2003 Sha et al.
 2005/0180895 A1 8/2005 Itoh
 2008/0131328 A1 6/2008 Schutt et al.
 2009/0065458 A1 3/2009 Murray
 2010/0203643 A1 8/2010 Self et al.
 2011/0274595 A1 11/2011 Ziegler
 2011/0306118 A1 12/2011 Belz et al.
 2012/0195808 A1 8/2012 Arras et al.
 2013/0195720 A1 8/2013 Behnk et al.
 2013/0315800 A1 * 11/2013 Yin B01L 9/523
 422/552
 2014/0140804 A1 5/2014 Focke et al.
 2014/0287515 A1 9/2014 Habrich et al.
 2015/0101911 A1 4/2015 Friedman
 2015/0174579 A1 6/2015 Iten et al.
 2016/0101422 A1 * 4/2016 Bucher B01L 9/543
 422/564
 2016/0161521 A1 6/2016 Sakairi et al.
 2016/0320421 A1 11/2016 Trump et al.
 2016/0333337 A1 11/2016 Duffy et al.
 2017/0043346 A1 * 2/2017 Welch A61B 5/15
 2017/0136467 A1 * 5/2017 Johns B01L 9/06

FOREIGN PATENT DOCUMENTS

CN 201689104 12/2010
 CN 201689104 U 12/2010
 CN 202078914 12/2011
 CN 202078914 U 12/2011
 CN 202277846 6/2012
 CN 202277846 U 6/2012
 CN 102989539 3/2013
 CN 102989539 A 3/2013
 DE 19849714 5/1999
 DE 19849714 A1 5/1999
 EP 0753748 1/1997
 EP 0753748 A2 1/1997
 EP 0965385 12/1999
 EP 0965385 A2 12/1999
 EP 2081128 A1 7/2009
 EP 2081128 12/2012
 EP 2081128 B1 12/2012
 EP 2179025 10/2016
 EP 2179025 B1 10/2016
 EP 3167962 5/2017
 EP 3167962 A1 5/2017
 GB 2520521 5/2015
 GB 2520521 A 5/2015
 JP 2001272408 10/2001
 JP 2001272408 A 10/2001
 JP 5686899 B2 1/2015
 JP 5686899 3/2015
 WO 2005093433 10/2005
 WO WO-2005093433 A1 10/2005
 WO 2006113854 10/2006
 WO WO-2006113854 A2 10/2006
 WO 2008014117 1/2008
 WO WO-2008014117 A2 1/2008
 WO 2012030877 3/2012
 WO WO-2012030877 A2 3/2012

OTHER PUBLICATIONS

U.S. Appl. No. 29/607,873, filed Jun. 16, 2017.
 U.S. Appl. No. 29/634,473, filed Jan. 22, 2018.
 U.S. Appl. No. 29/639,293, filed Mar. 5, 2018.
 EP15003260.5 , "Extended European Search Report", May 27, 2016, 7 pages.
 PCT/US2018/037930 , "International Search Report and Written Opinion", Aug. 9, 2018, 14 pages.
 "U.S. Appl. No. 29/639,293, Ex Parte Quayle Action mailed Jul. 24, 2018", 5 pgs.
 "U.S. Appl. No. 29/639,293, Notice of Allowance dated Oct. 16, 2018", 5 pgs.

(56)

References Cited

OTHER PUBLICATIONS

“U.S. Appl. No. 29/639,293, Preliminary Amendment filed Apr. 13, 2018”, 3 pgs.

“U.S. Appl. No. 29/639,293, Response filed Sep. 24, 2018 to Ex Parte Quayle Action mailed Jul. 24, 2018”, 5 pgs.

“European Application Serial No. 15003260,5, Extended European Search Report dated May 27, 2016”, 8 pgs.

“International Application Serial No. PCT/US2018/037930, International Search Report dated Aug. 9, 2018”, 5 pgs.

“International Application Serial No. PCT/US2018/037930, Written Opinion dated Aug. 9, 2018”, 7 pgs.

Johns, Charles W., et al., “U.S. Appl. No. 29/572,615, filed Jul. 28, 2016”, 18 pgs.

Liu, Niandong, et al., “U.S. Appl. No. 29/607,873, filed Jun. 16, 2017”, 27 pgs.

“U.S. Appl. No. 15/352,473, Final Office Action dated Oct. 4, 2018”, 10 pgs.

“U.S. Appl. No. 15/352,473, Non Final Office Action dated Mar. 15, 2019”, 9 pgs.

“U.S. Appl. No. 15/352,473, Non Final Office Action dated Apr. 2, 2018”, 12 pgs.

“U.S. Appl. No. 15/352,473, Preliminary Amendment filed Nov. 15, 2016”, 8 pgs.

“U.S. Appl. No. 15/352,473, Response filed Mar. 4, 2019 to Final Office Action dated Oct. 4, 2018”, 9 pgs.

“U.S. Appl. No. 15/352,473, Response filed Aug. 2, 2018 to Non Final Office Action dated Apr. 2, 2018”, 11 pgs.

“U.S. Appl. No. 15/352,473, Response filed Jul. 15, 2019 to Non-Final Office Action dated Mar. 15, 2019”, 16 pgs.

“U.S. Appl. No. 29/572,596, Ex Parte Quayle Action mailed Jun. 1, 2017”, 6 pgs.

“U.S. Appl. No. 29/572,596, Notice of Allowance dated Jan. 19, 2018”, 7 pgs.

“U.S. Appl. No. 29/572,596, Response filed Aug. 1, 2017 to Ex Parte Quayle Action mailed Jun. 1, 2017”, 5 pgs.

Johns, Charles W., et al., “U.S. Appl. No. 29/634,473, filed Jan. 22, 2018”, 18 pgs.

Johns, Charles W., et al., “U.S. Appl. No. 29/639,293, filed Mar. 5, 2018”, 9 pgs.

Johns, Charles W., et al., “U.S. Appl. No. 29/572,596, filed Jul. 28, 2016”, 9 pgs.

“U.S. Appl. No. 29/607,873, Response filed Dec. 6, 2019 to Non Final Office Action dated Sep. 6, 2019”, 6 pgs.

“U.S. Appl. No. 15/352,473, Response filed Dec. 16, 2019 to Final Office Action dated Oct. 16, 2019”, 19 pgs.

“U.S. Appl. No. 16/622,168 Preliminary Amendment filed Dec. 12, 2019”, 9 pgs.

* cited by examiner

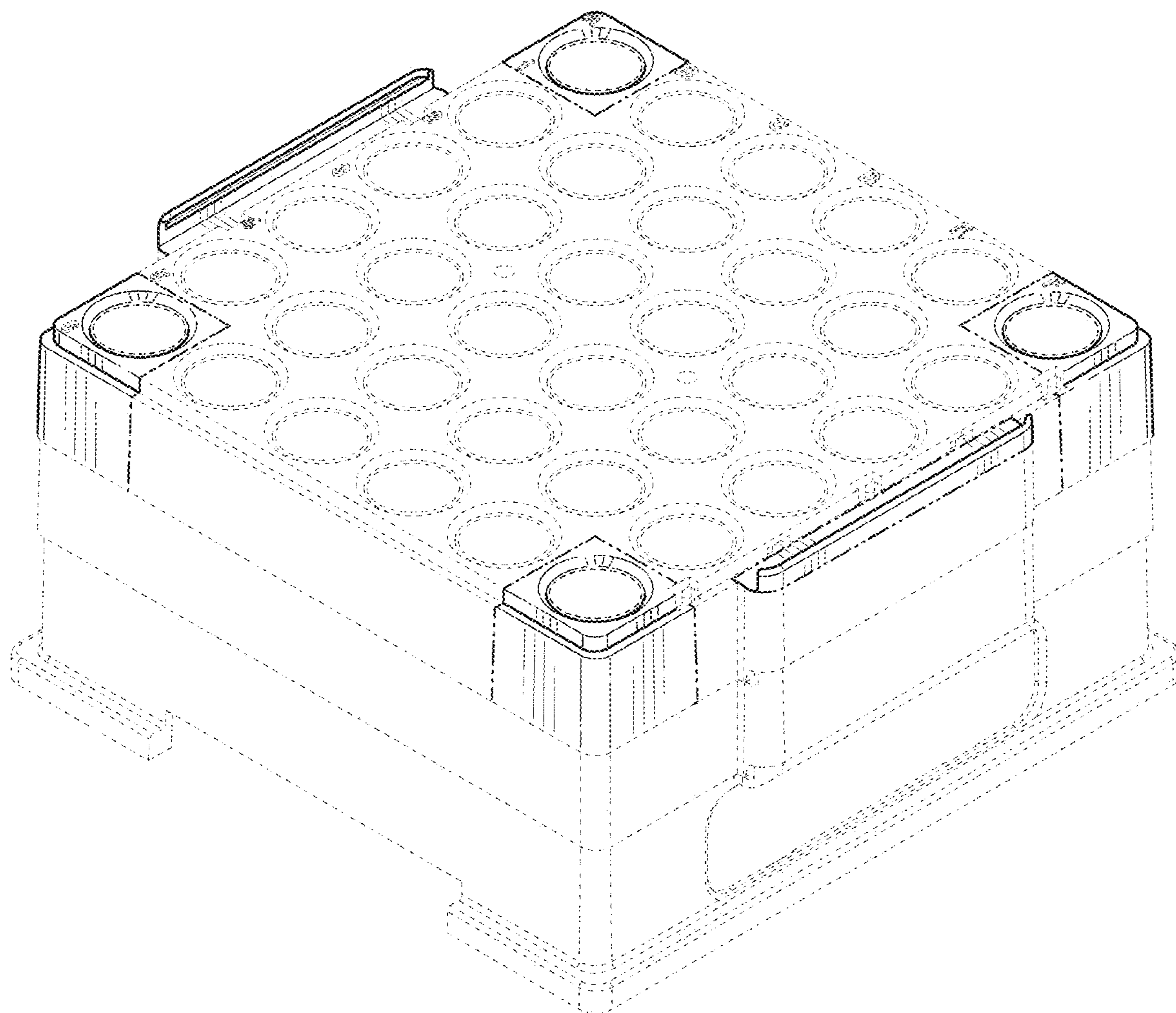

FIG. 1

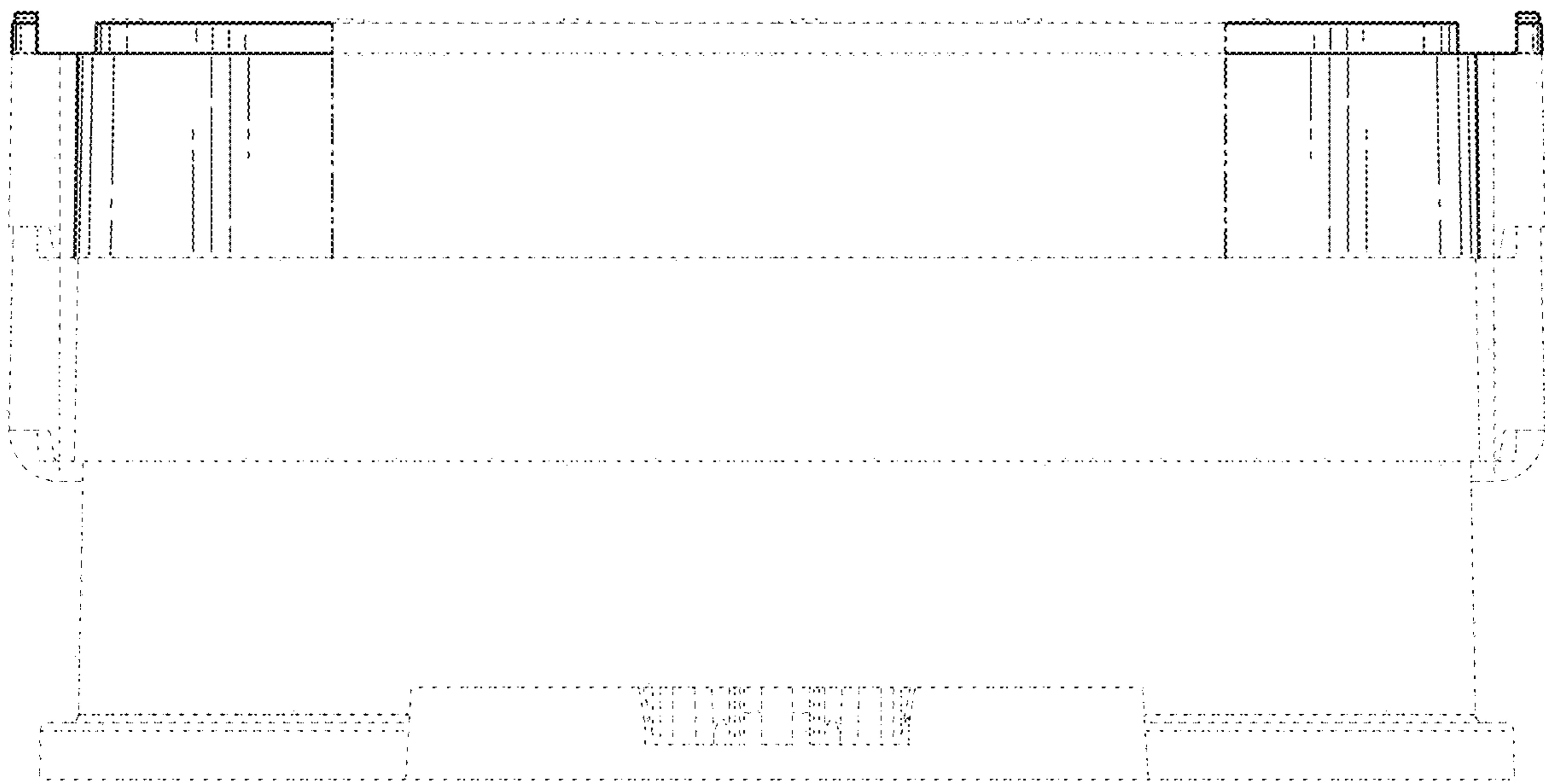

FIG. 2



FIG. 3

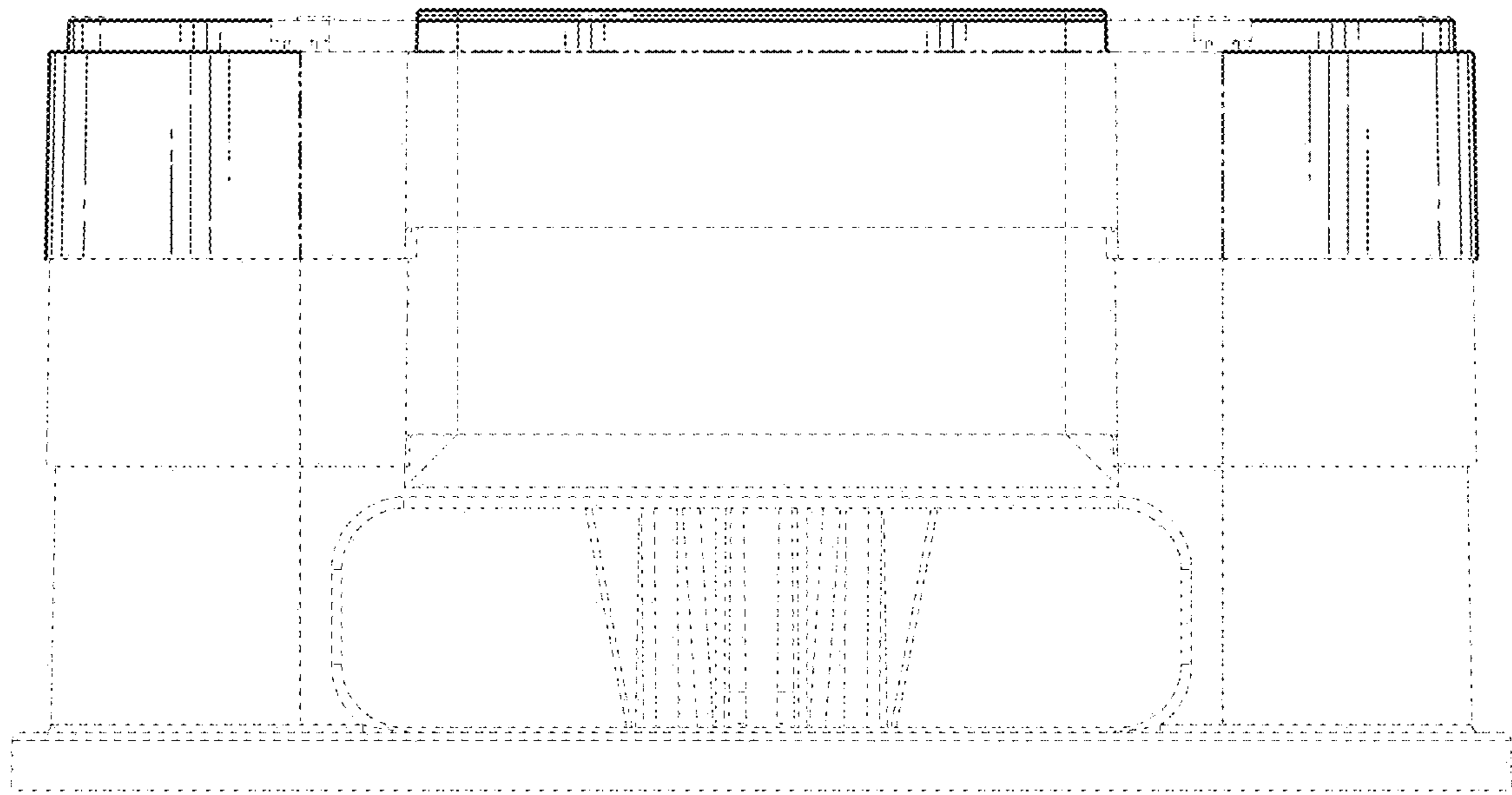

FIG. 4

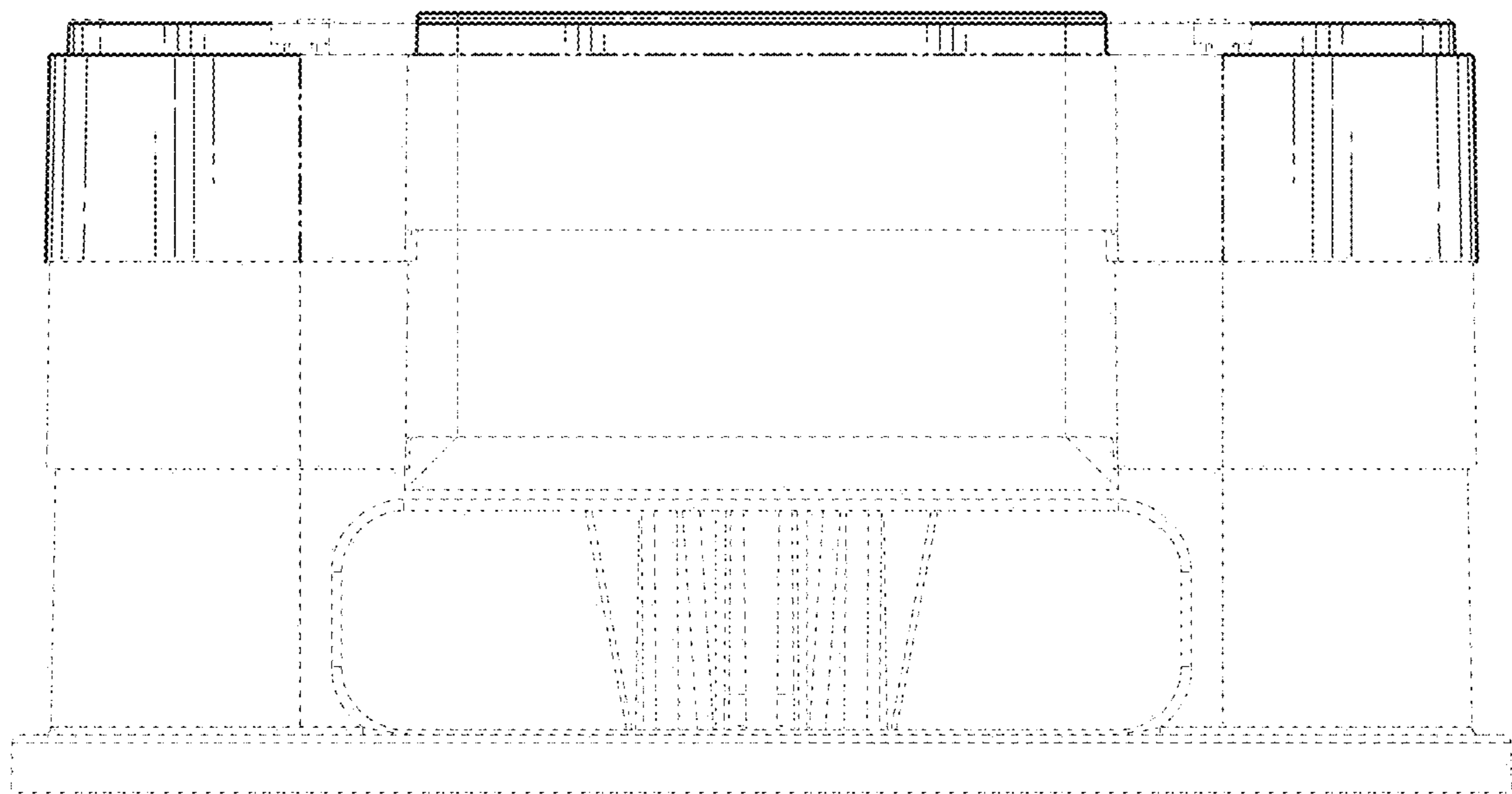

FIG. 5

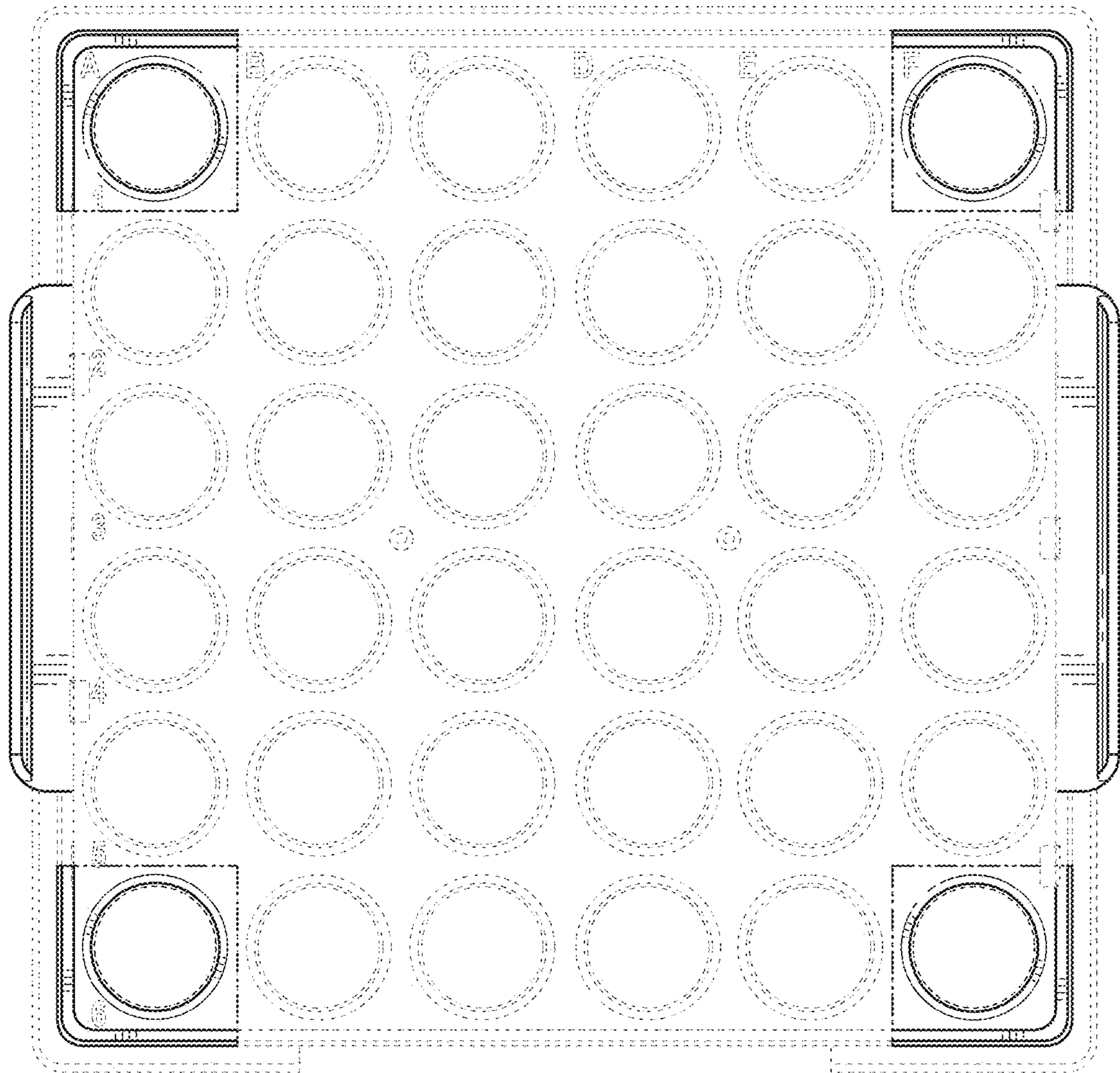

FIG. 6

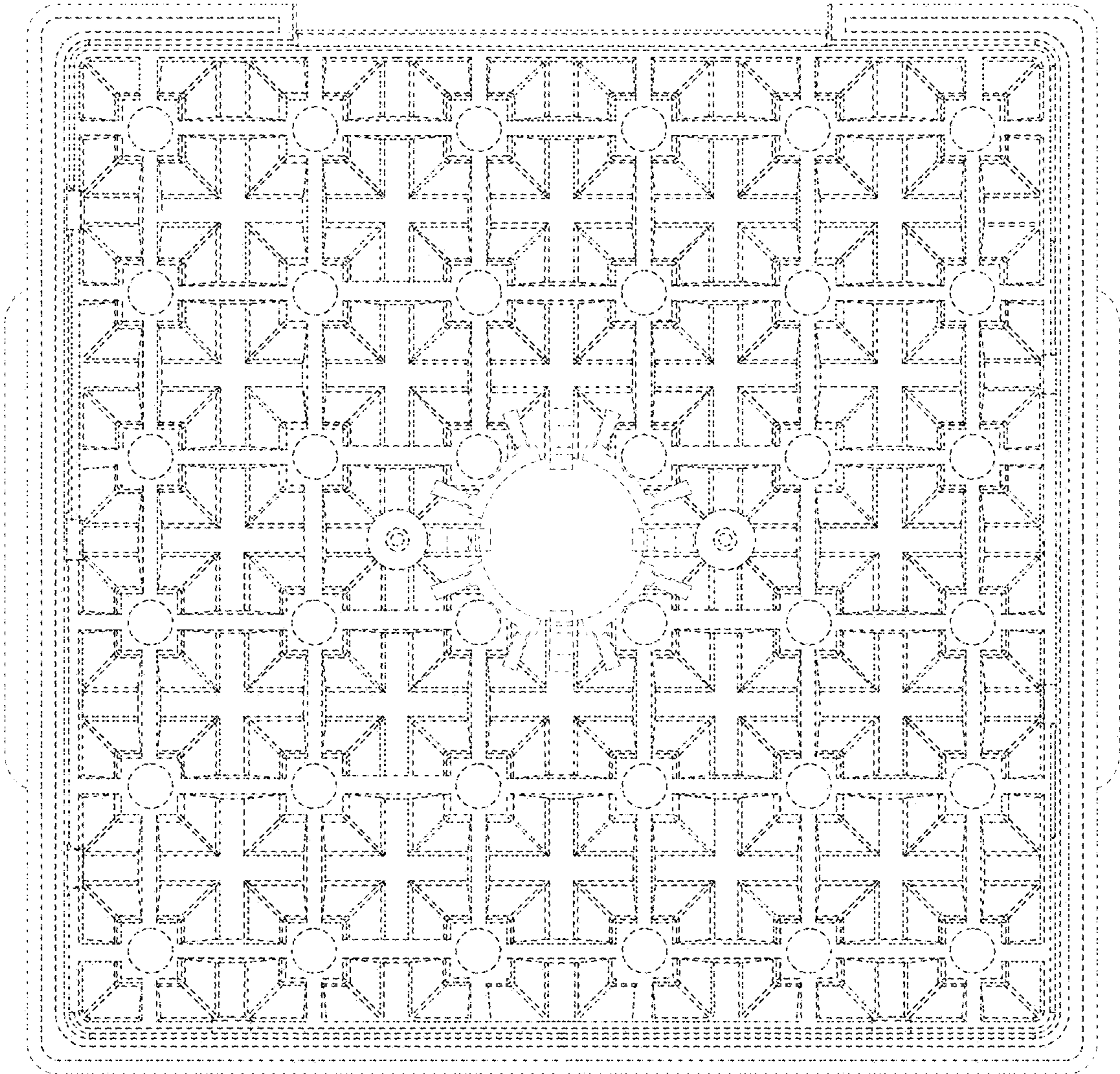

FIG. 7

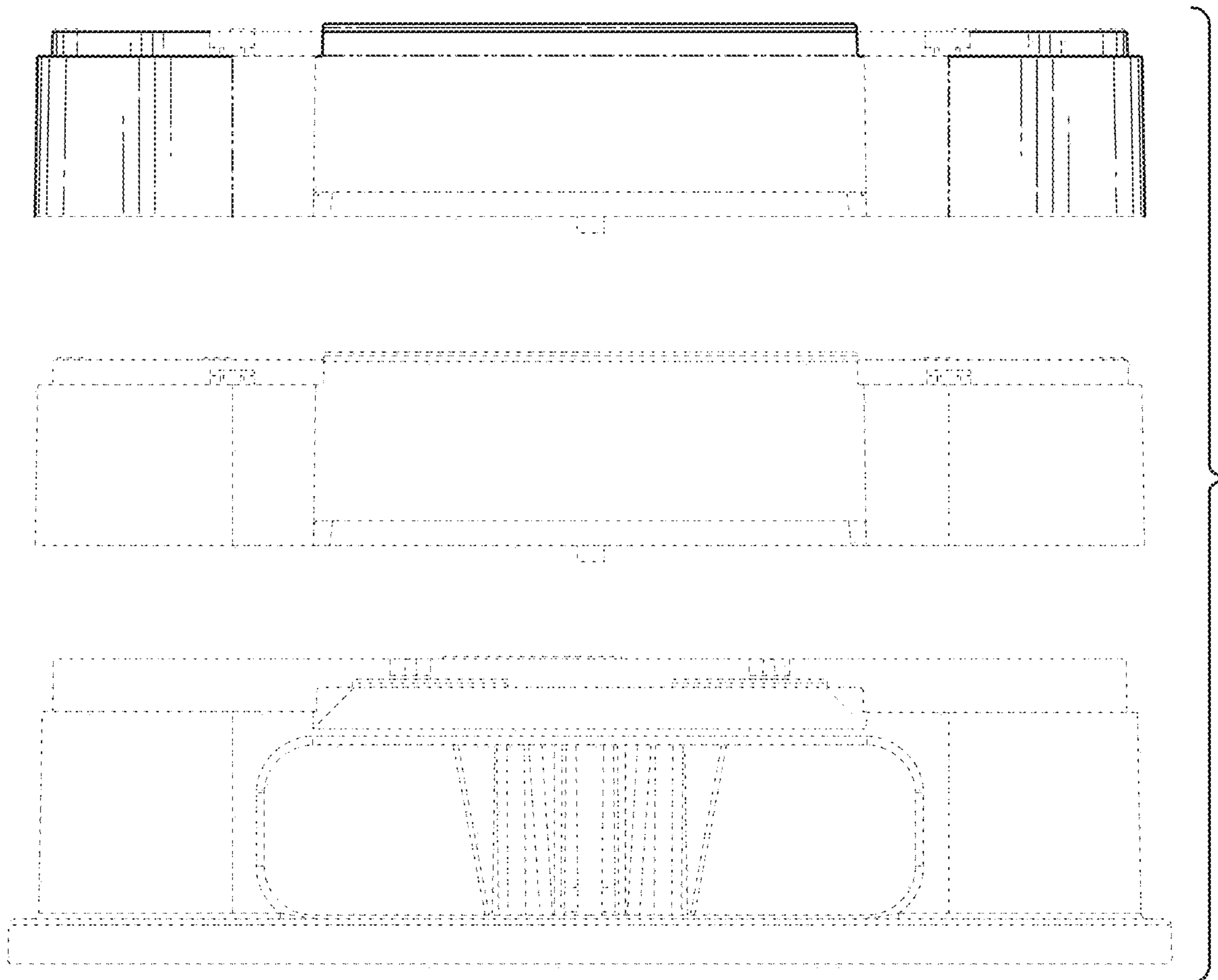

FIG. 8