



US00D885459S

(12) **United States Design Patent** (10) **Patent No.:** **US D885,459 S**
Vozzi et al. (45) **Date of Patent:** **** May 26, 2020**

(54) **CAMERA**

(71) Applicant: **Axis AB**, Lund (SE)

(72) Inventors: **Mariano Vozzi**, Lund (SE); **Stefan Möller**, Lund (SE); **Jonas Sjögren**, Lund (SE); **Mathias Walter**, Lund (SE); **Karl Andersson**, Lund (SE)

(73) Assignee: **AXIS AB**, Lund (SE)

(**) Term: **15 Years**

(21) Appl. No.: **29/696,122**

(22) Filed: **Jun. 25, 2019**

(30) **Foreign Application Priority Data**

Jan. 15, 2019 (EM) 006023545

(51) **LOC (12) Cl.** **16-01**

(52) **U.S. Cl.**
USPC **D16/203**

(58) **Field of Classification Search**
USPC D16/200, 202-208, 218, 219, 242;
348/143, 148, 151, 373-376; 396/419,
396/427, 535, 539-541; 248/176.1, 187.1
CPC G03B 17/02; G03B 19/04; G03B 17/56;
G03B 17/04; G03B 15/03; H04N 5/2251;
H04N 5/2252; H04N 5/2253; H04N
5/2254; H04N 7/181; H04N 7/183; H04N
7/18

See application file for complete search history.

(56) **References Cited**

U.S. PATENT DOCUMENTS

D607,033 S * 12/2009 Arbuckle D16/203
D638,871 S * 5/2011 Bergstrom D16/203
D642,607 S * 8/2011 Bergstrom D16/203
D643,454 S * 8/2011 Zaliauskas D16/202
D684,619 S * 6/2013 Chapple D16/203
D748,710 S * 2/2016 Bergstrom D16/203
D812,670 S * 3/2018 Andersson D16/203

D826,305 S * 8/2018 Ahman D16/203
D827,013 S * 8/2018 Ahman D16/203
D832,330 S * 10/2018 Ahman D16/203
D835,697 S * 12/2018 Andersson D16/203
D836,149 S * 12/2018 Ahman D16/203
D848,505 S * 5/2019 Bull D16/203

FOREIGN PATENT DOCUMENTS

EM 001173686 10/2009
EM 002344721 11/2013
EM 003050210 3/2016
EM 005255577 5/2018
TW 181783 D 3/2017
TW 187033 D 12/2017

OTHER PUBLICATIONS

Taiwanese Search Report for corresponding Taiwanese Design Patent Application No. 108304155. Search completed on Feb. 4, 2020, 4 pages.

* cited by examiner

Primary Examiner — Ramzi S Almatrahi

(74) *Attorney, Agent, or Firm* — Tucker Ellis LLP

(57) **CLAIM**

The ornamental design for a camera, as shown and described.

DESCRIPTION

FIG. 1 is a front-left-top perspective view of a camera showing our new design;
FIG. 2 is a front view thereof;
FIG. 3 is a rear view thereof;
FIG. 4 is a left side view thereof;
FIG. 5 is a right side view thereof;
FIG. 6 is a top view thereof; and,
FIG. 7 is a bottom view thereof.
The broken lines are for the purpose of illustrating portions of the camera and form no part of the claimed design.

1 Claim, 6 Drawing Sheets

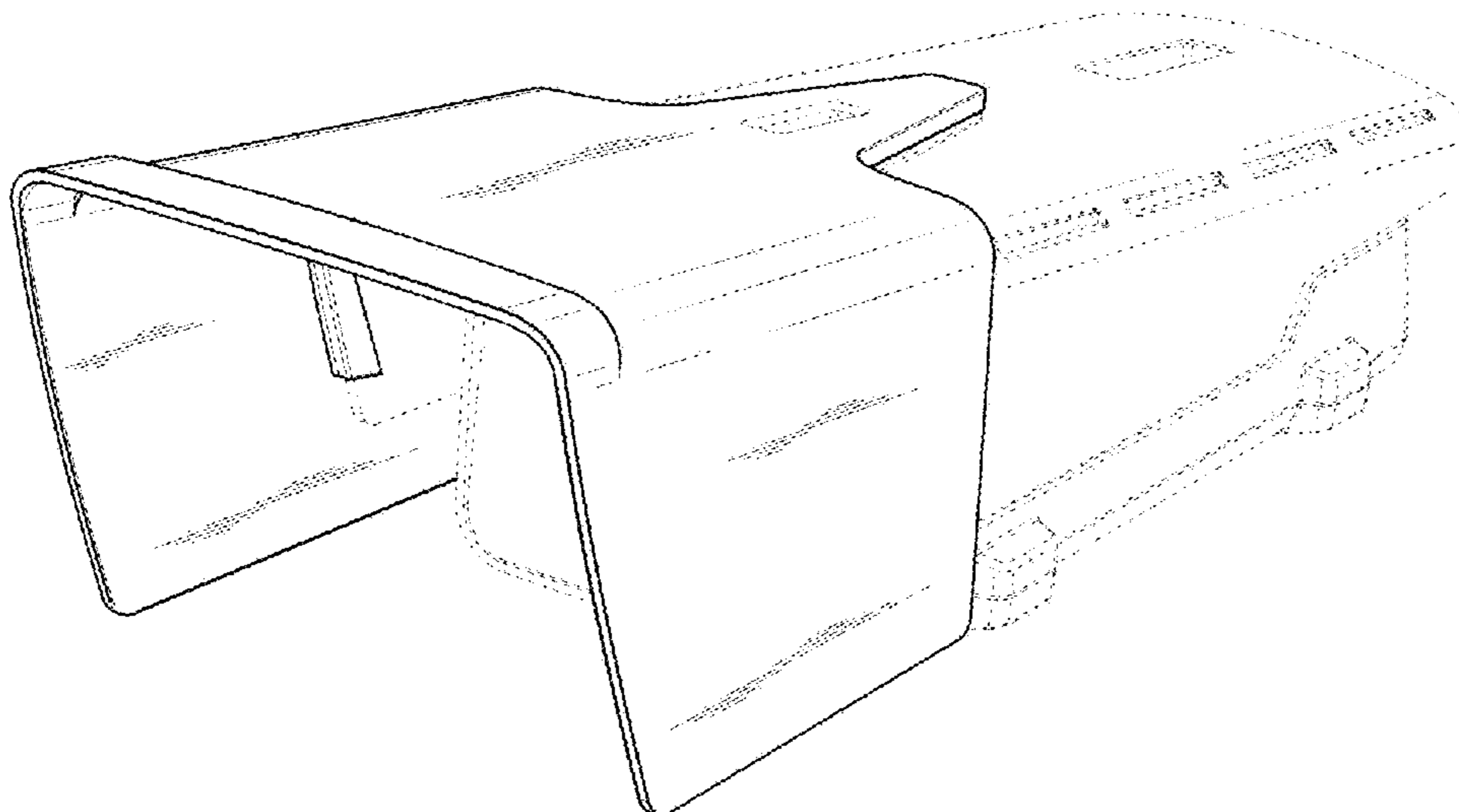

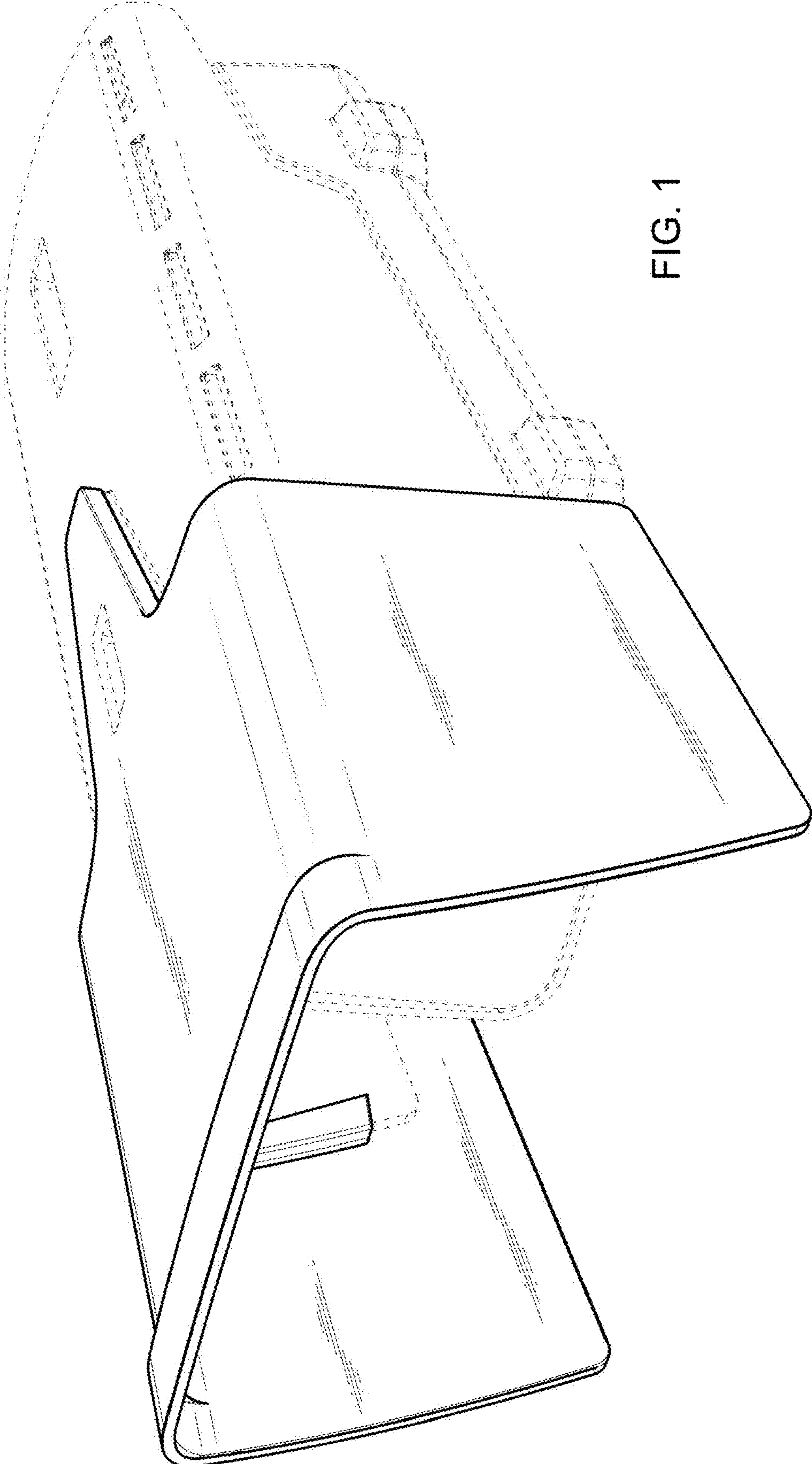

FIG. 1

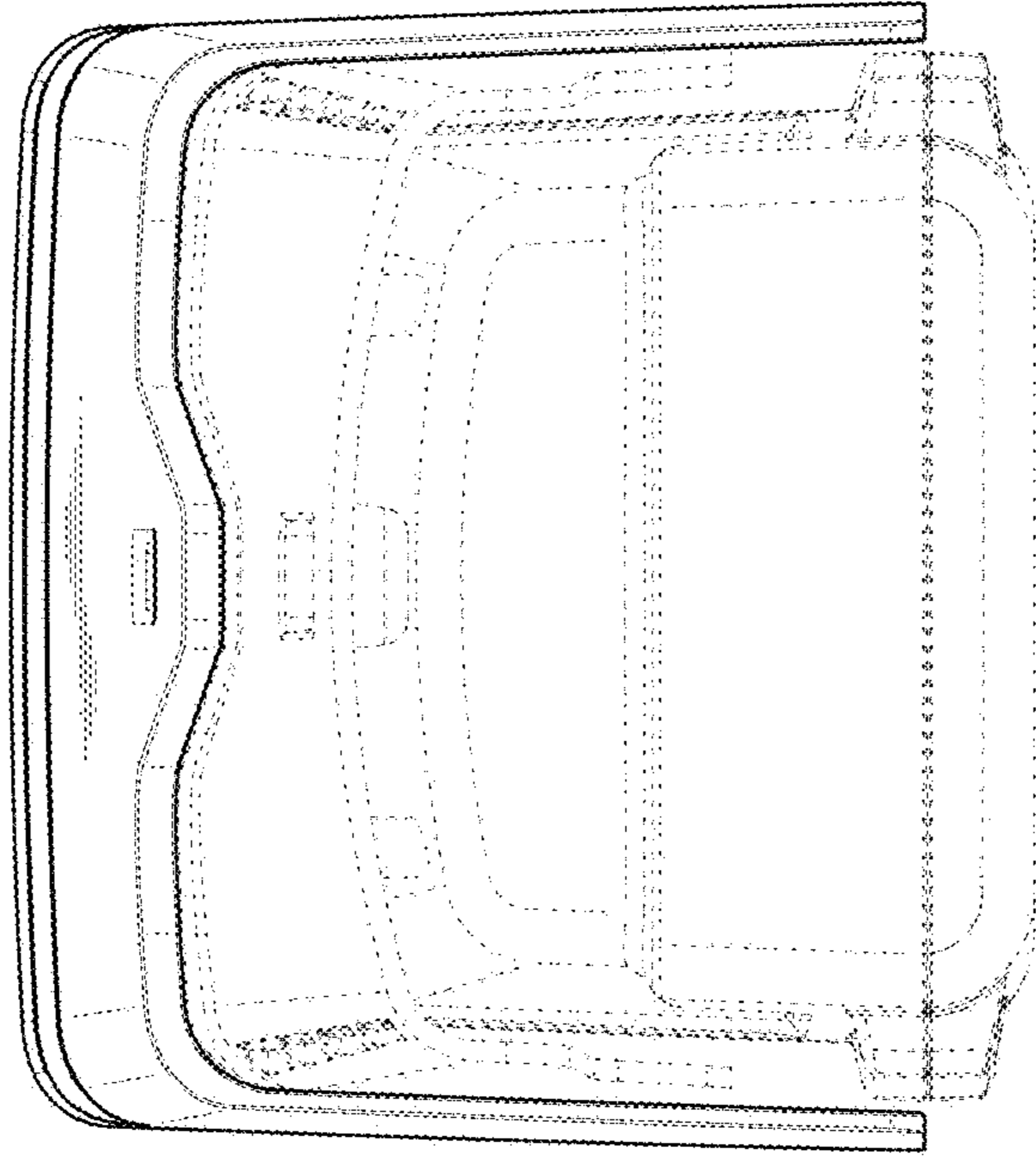

FIG. 2

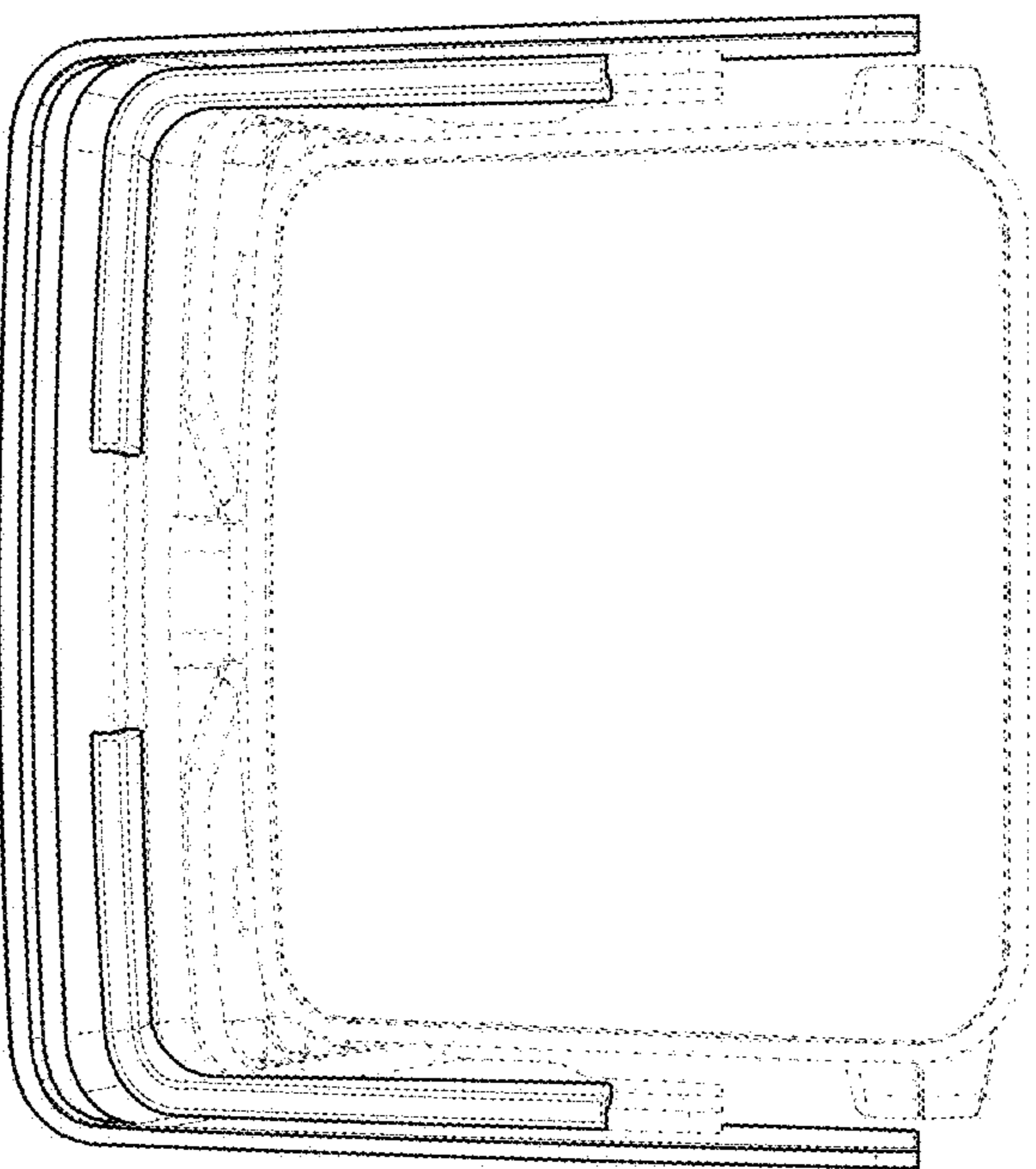

FIG. 3

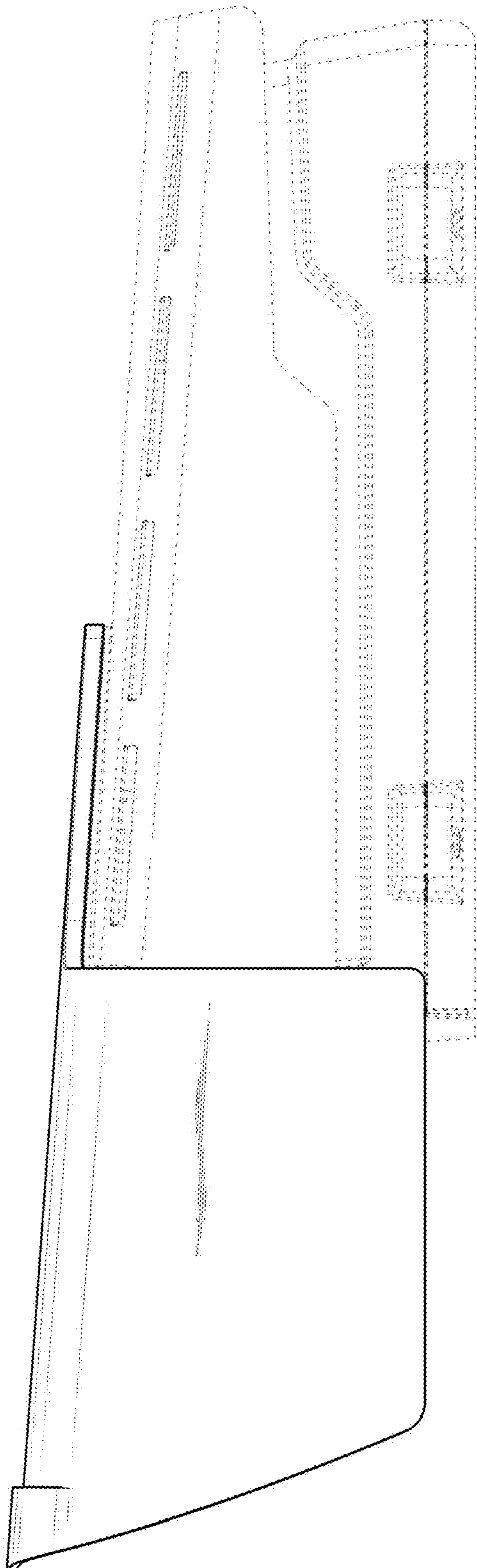

FIG. 4

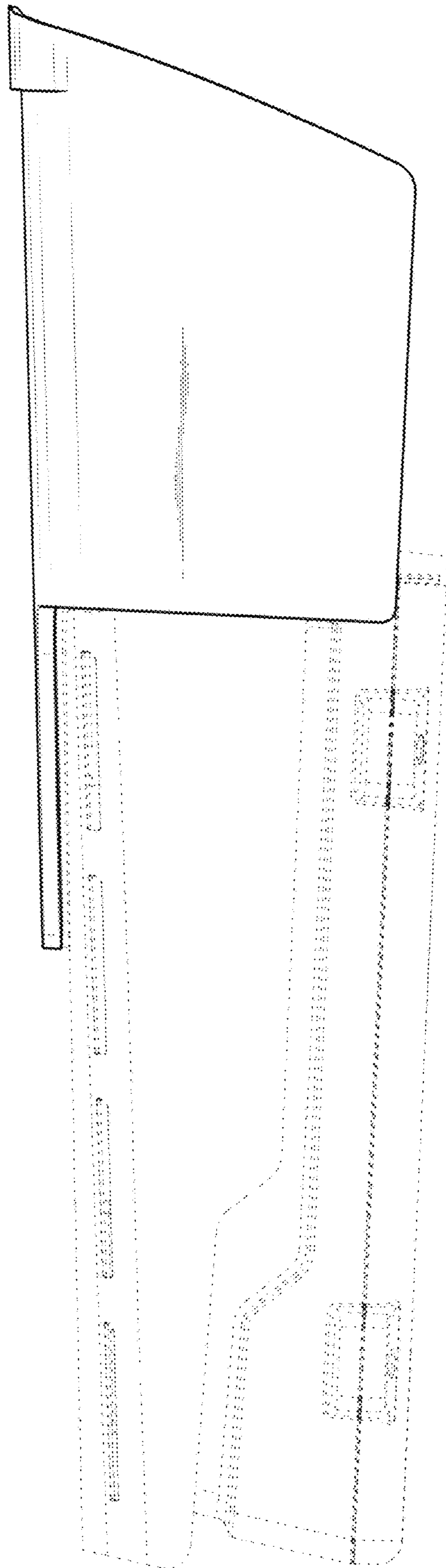

FIG. 5

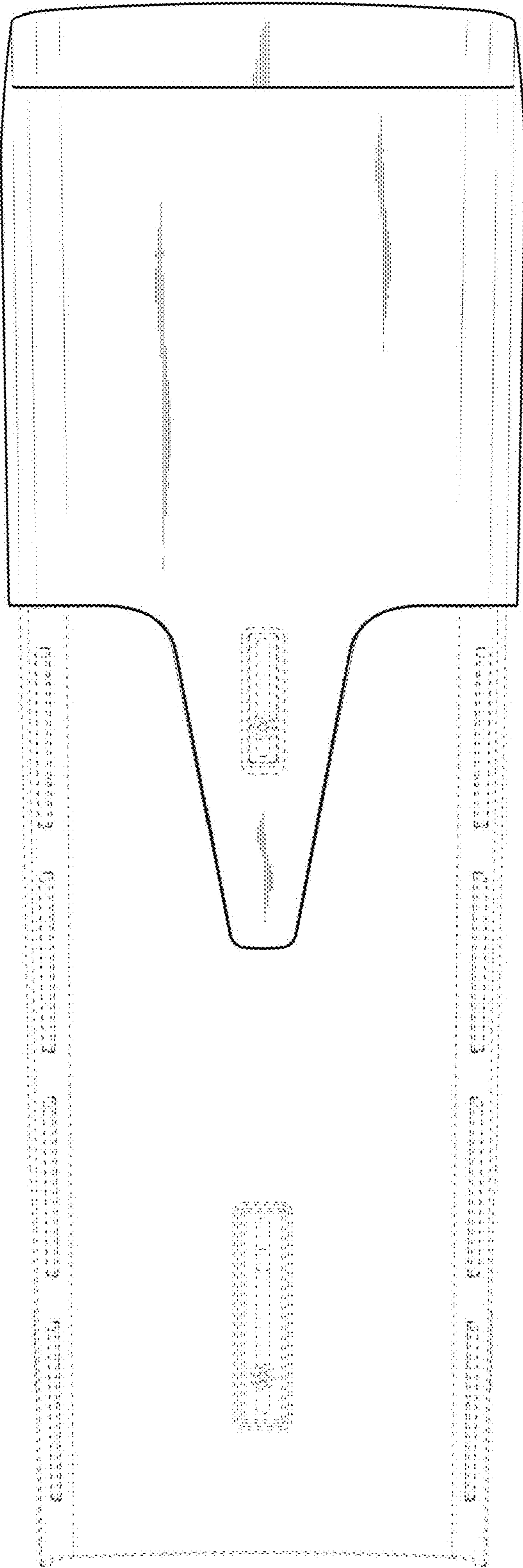

FIG. 6

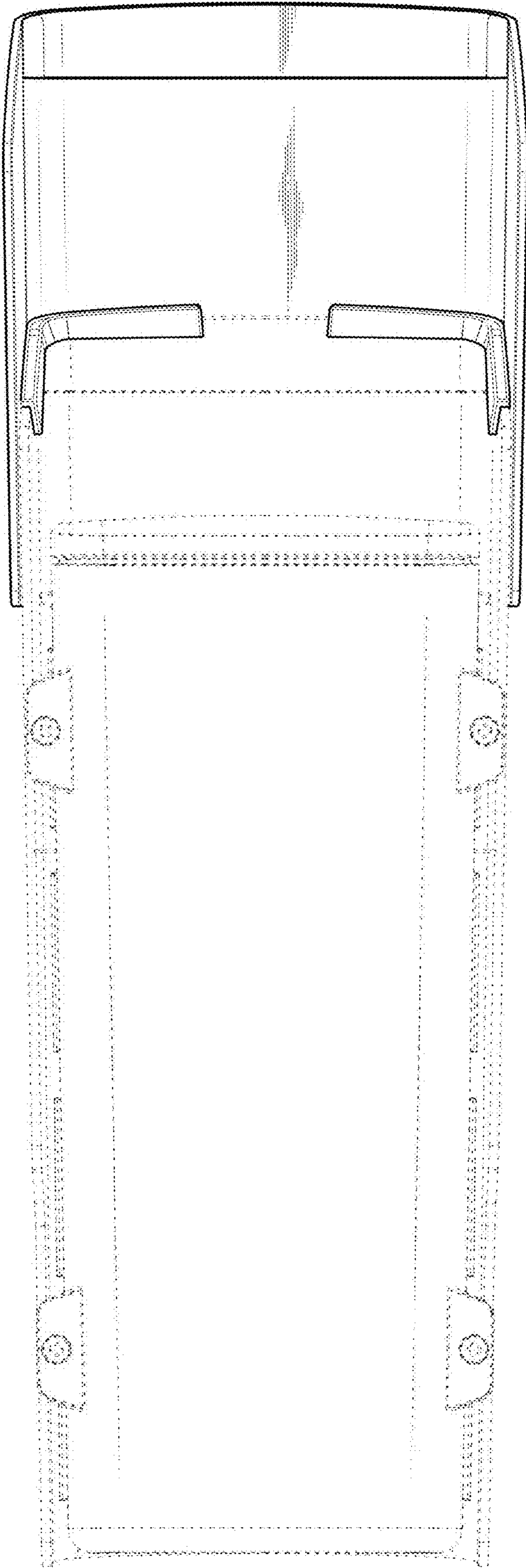

FIG. 7