



US00D885390S

(12) **United States Design Patent**  
**Sun et al.**

(10) **Patent No.:** **US D885,390 S**  
(45) **Date of Patent:** **\*\* May 26, 2020**

(54) **ADAPTER**

(71) Applicants: **Chia-Chi Sun**, Taipei (TW); **Yun-Tung Pai**, Taipei (TW); **Yen-Hua Hsiao**, Taipei (TW); **Yi-Hsuan Lin**, Taipei (TW); **Jui-Hsien Chien**, Taipei (TW); **Han-Sheng Siao**, Taipei (TW)

(72) Inventors: **Chia-Chi Sun**, Taipei (TW); **Yun-Tung Pai**, Taipei (TW); **Yen-Hua Hsiao**, Taipei (TW); **Yi-Hsuan Lin**, Taipei (TW); **Jui-Hsien Chien**, Taipei (TW); **Han-Sheng Siao**, Taipei (TW)

(73) Assignee: **COMPAL ELECTRONICS, INC.**, Taipei (TW)

(\*\*) Term: **15 Years**

(21) Appl. No.: **29/661,558**

(22) Filed: **Aug. 29, 2018**

(51) **LOC (12) Cl.** ..... **14-02**

(52) **U.S. Cl.**  
USPC ..... **D14/433**

(58) **Field of Classification Search**  
USPC ... D14/434, 433, 435, 435.1, 356, 357, 358, D14/440, 447, 251-253, 432, 451, 452,  
(Continued)

(56) **References Cited**

**PUBLICATIONS**

UniSlim\_iF World Design Guide. ifworlddesignguide.com. (online) 3 pgs. Launch Date 2019. [Retrieved on Aug. 6, 2019] <https://ifworlddesignguide.com/entry/248254-unislim>.\*

\* cited by examiner

*Primary Examiner* — Marie D. Fast Horse

(74) *Attorney, Agent, or Firm* — JCIPRNET

(57) **CLAIM**

The ornamental design for an adapter, as shown and described.

**DESCRIPTION**

FIG. 1 is a front, right, top perspective view of an adapter showing our new design;  
FIG. 2 is a rear, right, bottom perspective view thereof;  
FIG. 3 is a rear, right, top perspective view thereof;  
FIG. 4 is a front view thereof;  
FIG. 5 is a rear view thereof;  
FIG. 6 is a left side view thereof;  
FIG. 7 is a right side view thereof;  
FIG. 8 is a top view thereof;  
FIG. 9 is a bottom view thereof;  
FIG. 10 is a front, right, top perspective thereof with the upper member of the adapter opened relative to the lower member of the adapter;  
FIG. 11 is a rear, right, bottom perspective view thereof with the upper member of the adapter opened relative to the lower member of the adapter;  
FIG. 12 is a rear, right, top perspective view thereof with the upper member of the adapter opened relative to the lower member of the adapter;  
FIG. 13 is a front view thereof with the upper member of the adapter opened relative to the lower member of the adapter;  
FIG. 14 is a rear view thereof with the upper member of the adapter opened relative to the lower member of the adapter;  
FIG. 15 is a left side view thereof with the upper member of the adapter opened relative to the lower member of the adapter;  
FIG. 16 is a right side view thereof with the upper member of the adapter opened relative to the lower member of the adapter;  
FIG. 17 is a top view thereof with the upper member of the adapter opened relative to the lower member of the adapter;  
FIG. 18 is a bottom view thereof with the upper member of the adapter opened relative to the lower member of the adapter;  
FIG. 19 is a perspective view thereof with the adapter clamped to a notebook computer in an open state;  
FIG. 20 is an enlarged view of the portion, labeled '20' of FIG. 19;

(Continued)

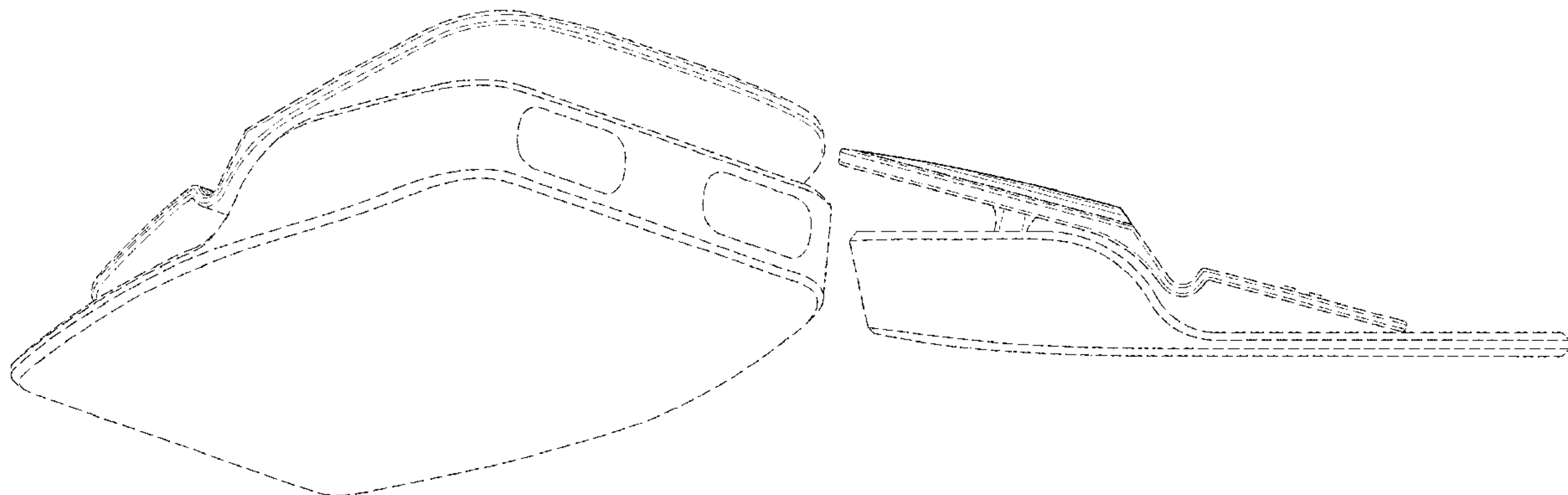

FIG. 21 is a perspective view thereof with the adapter clamped to a notebook computer in a closed state; and, FIG. 22 is an enlarged view of the portion, labeled '22' of FIG. 21.

The broken lines consisting of a long dash and two short dashes depict reference to the enlargements shown in FIGS. 19-22 and form no part of the claim. The broken line consisting of long dash and one short dash defines the boundary of the claim, which extends to the boundary but does not include the boundary. The broken line showing the additional notebook computer in FIGS. 19-22 depict environmental subject matter only and form no part of the claim, while all other broken lines depict portions of the adapter that form no part of the claimed design.

**1 Claim, 18 Drawing Sheets**

**(58) Field of Classification Search**

USPC ..... D14/454, 217, 240, 299, 496, 171;  
D13/103, 107, 108, 184, 110, 123, 133,  
D13/135; D21/333; D8/394, 395;  
D19/65, 86, 99  
CPC ..... G06F 1/1632; G06F 13/00; G06F 13/38;  
G06F 13/382; G06F 13/385; G06F  
13/387; G06F 3/065; G06F 9/541; G06F  
2213/3814; G06F 2213/40; G06F  
2213/4004; H01R 31/06; H01R 31/065;  
H01R 27/00; H04R 5/04

See application file for complete search history.

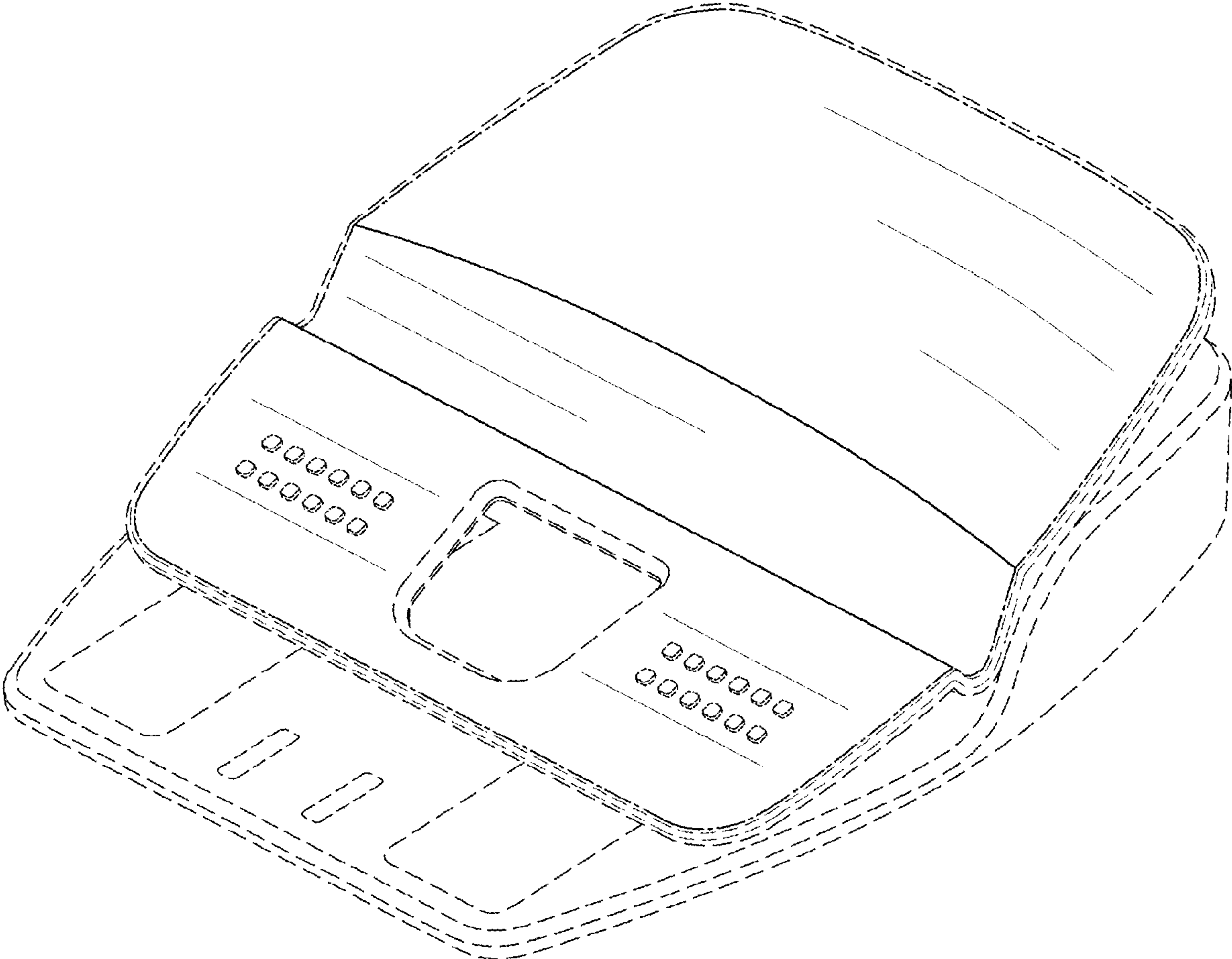

FIG. 1

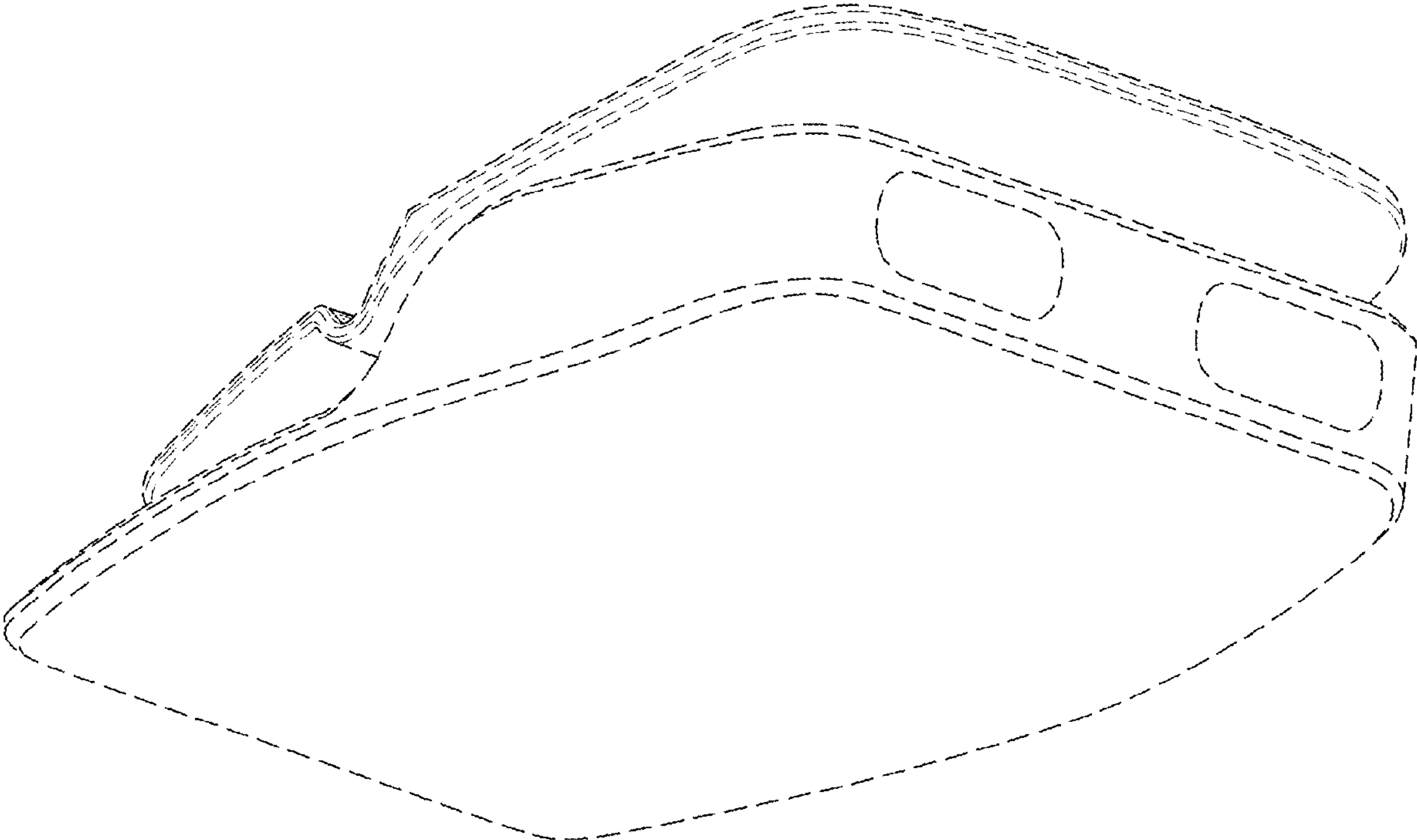

FIG. 2

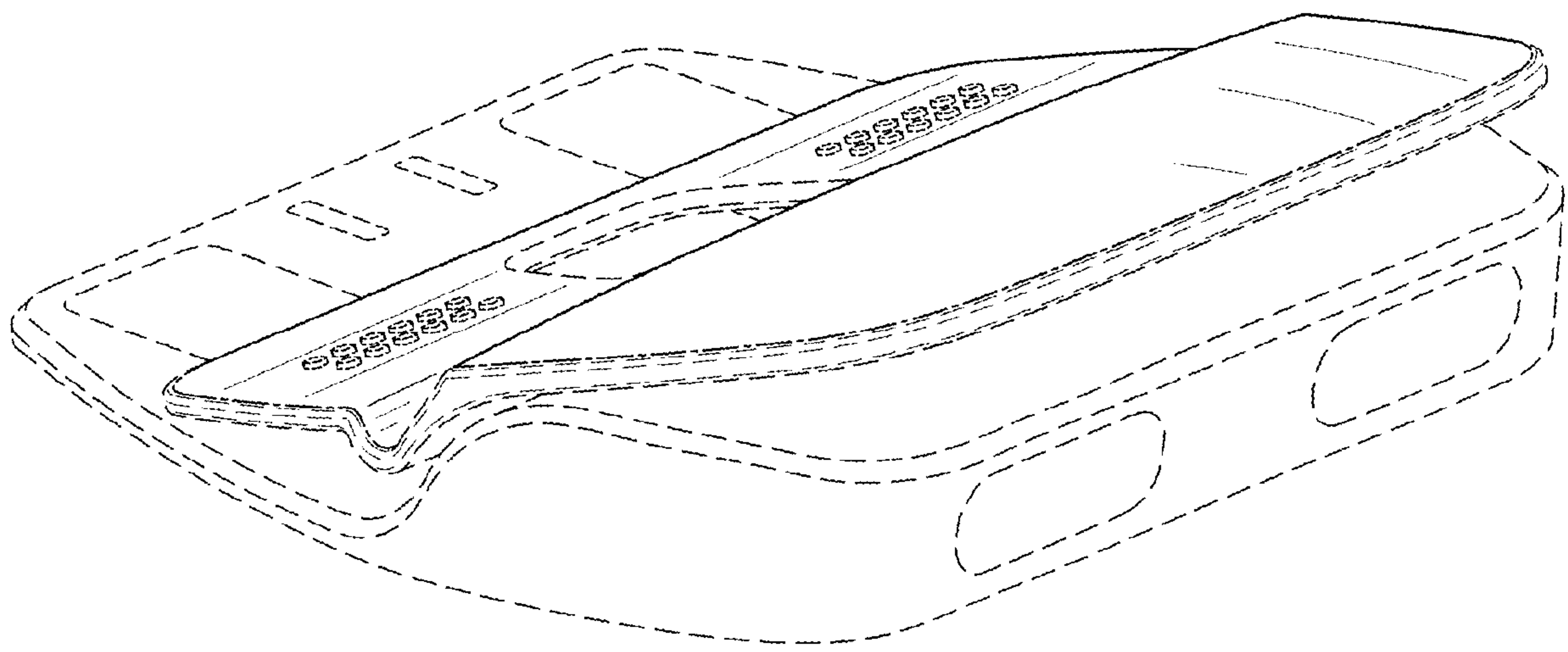

FIG. 3



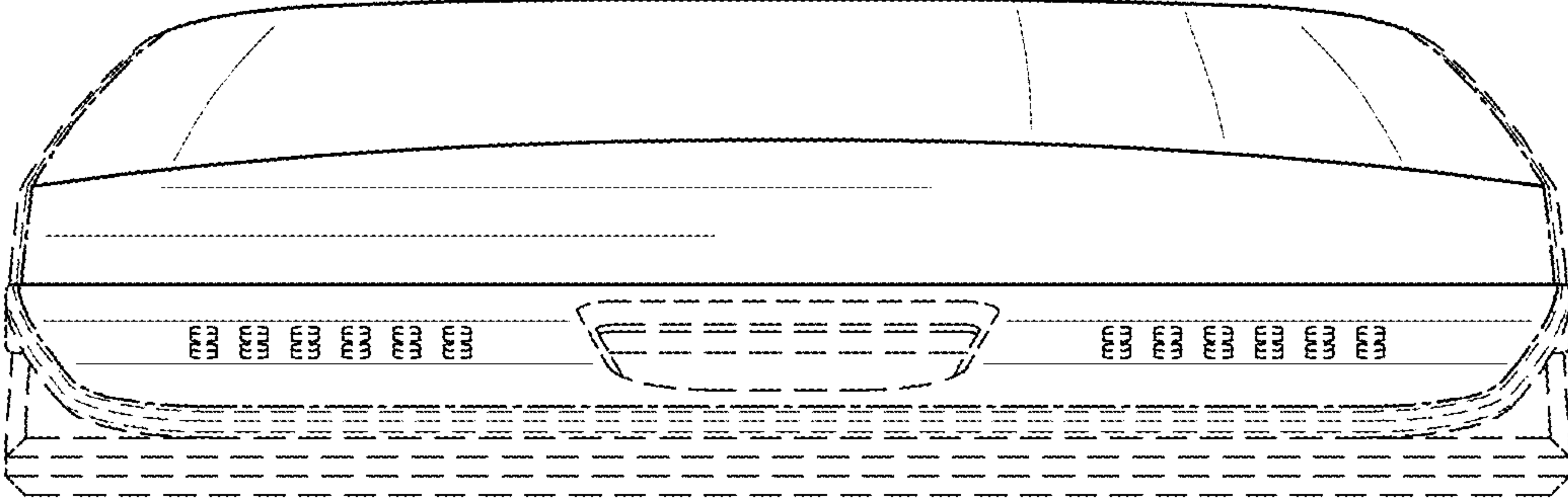

FIG. 4

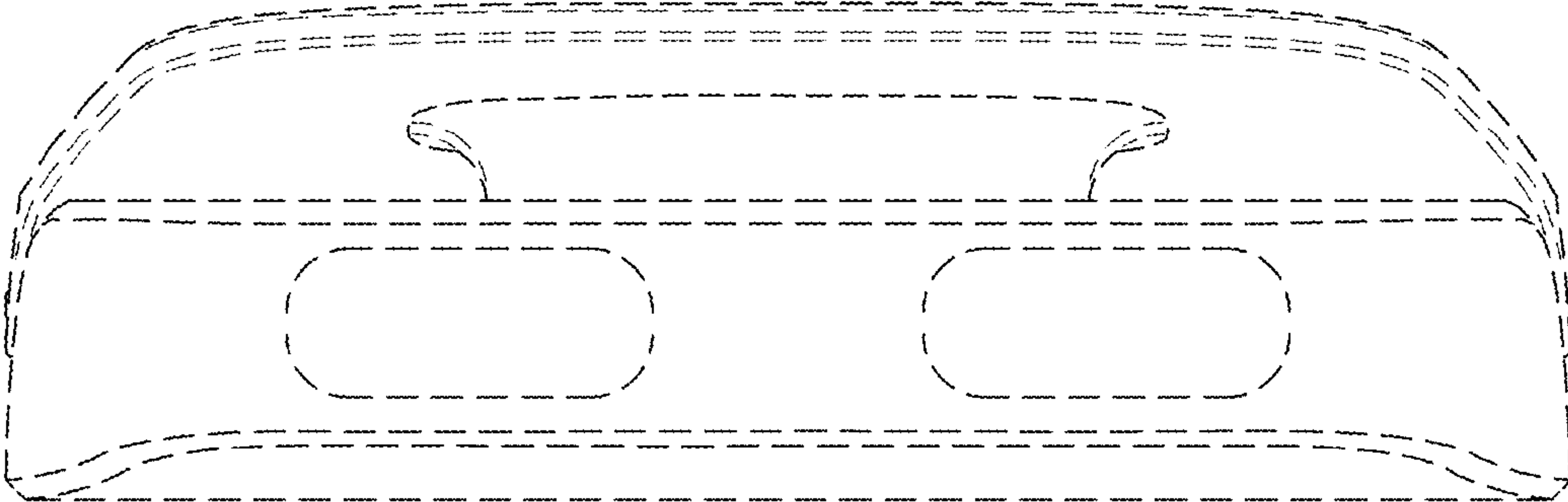

FIG. 5

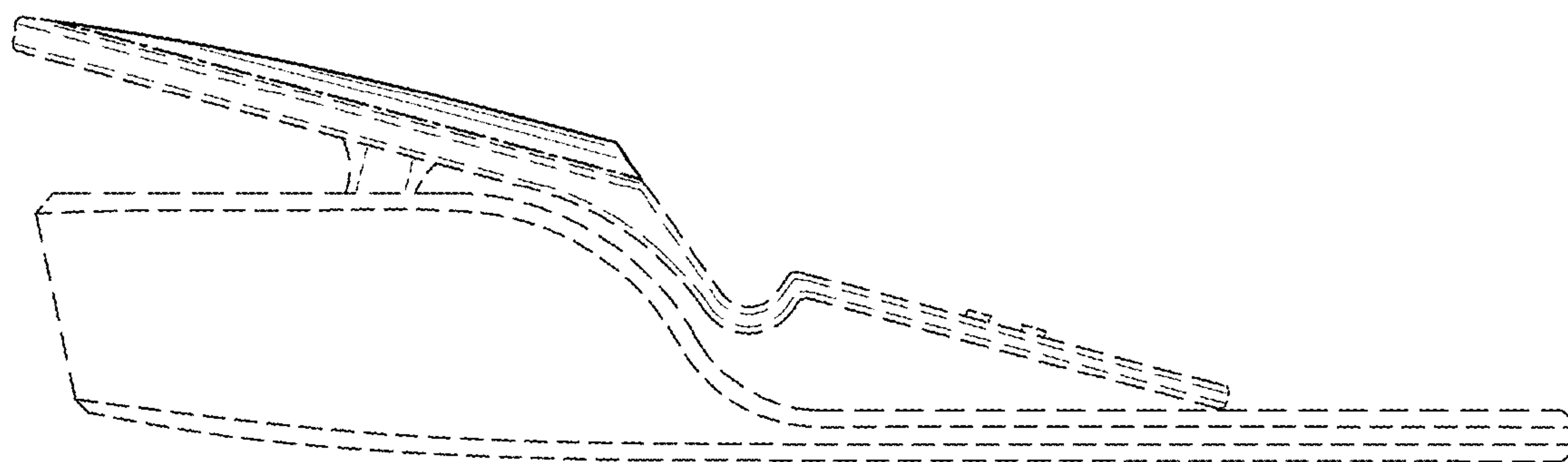

FIG. 6

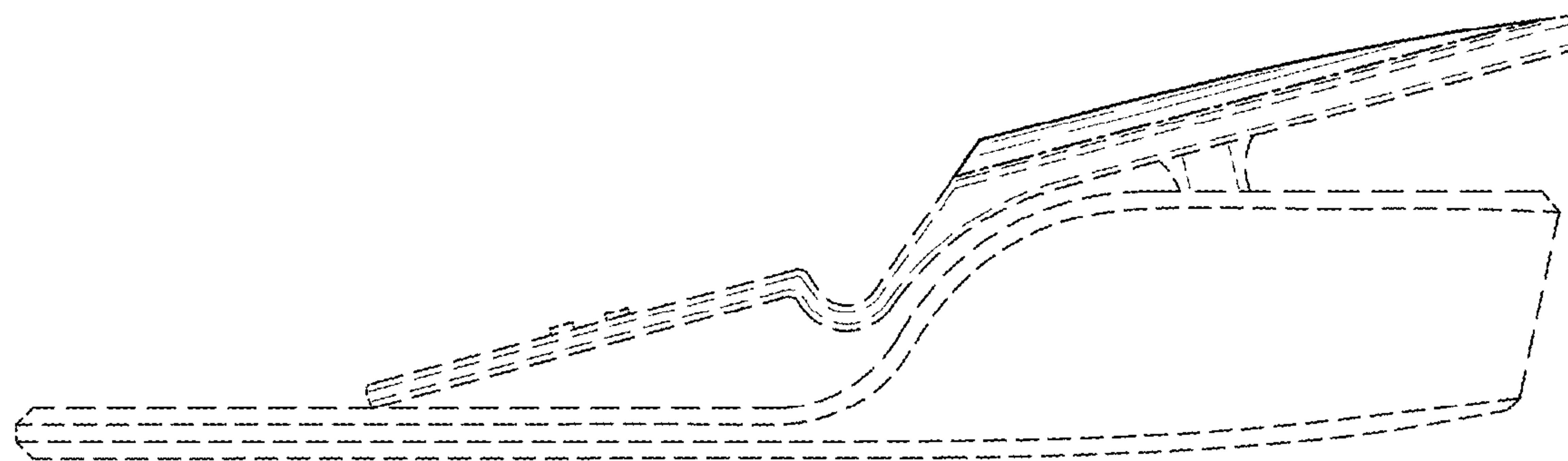

FIG. 7

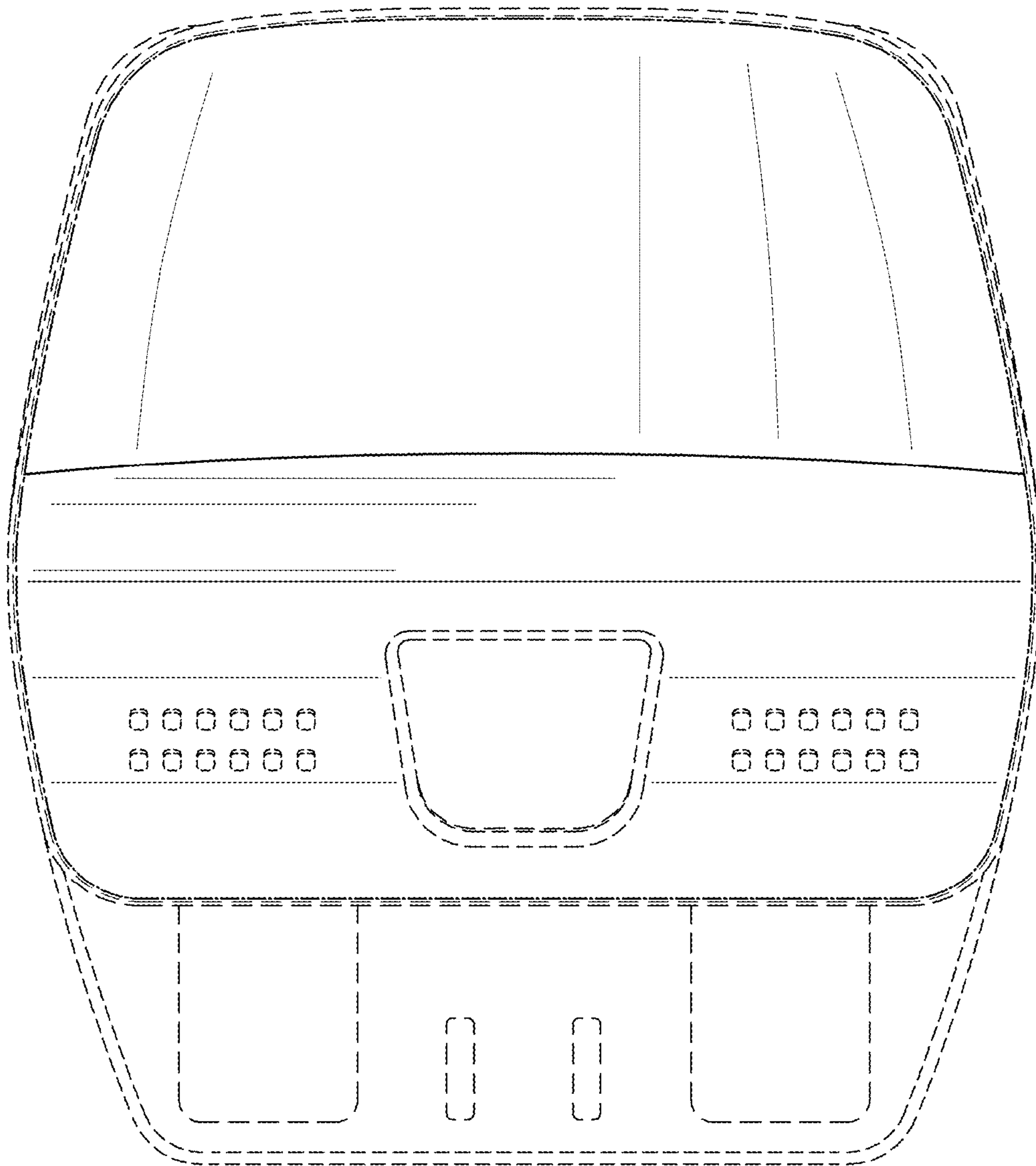

FIG. 8





FIG. 9

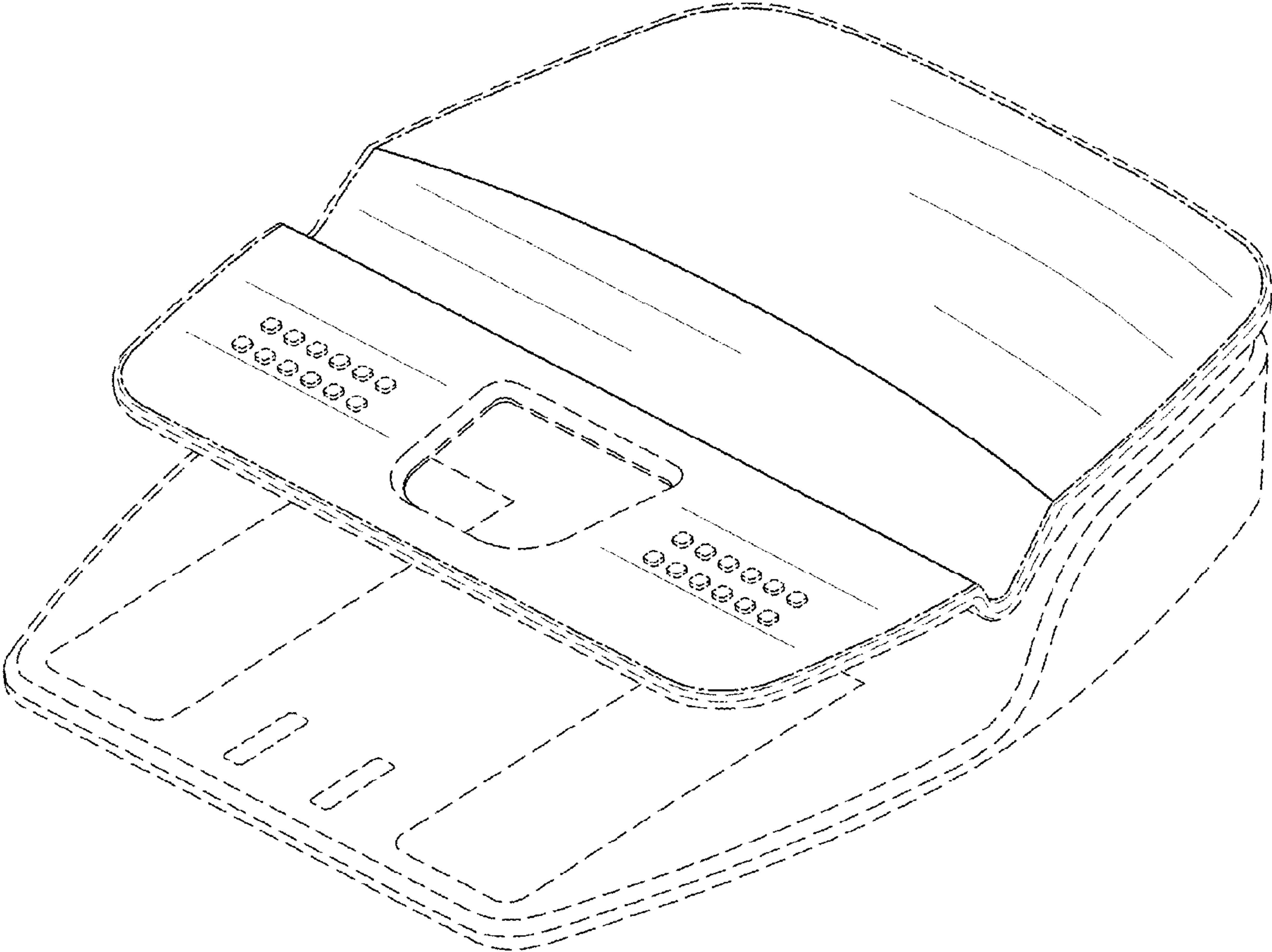

FIG. 10

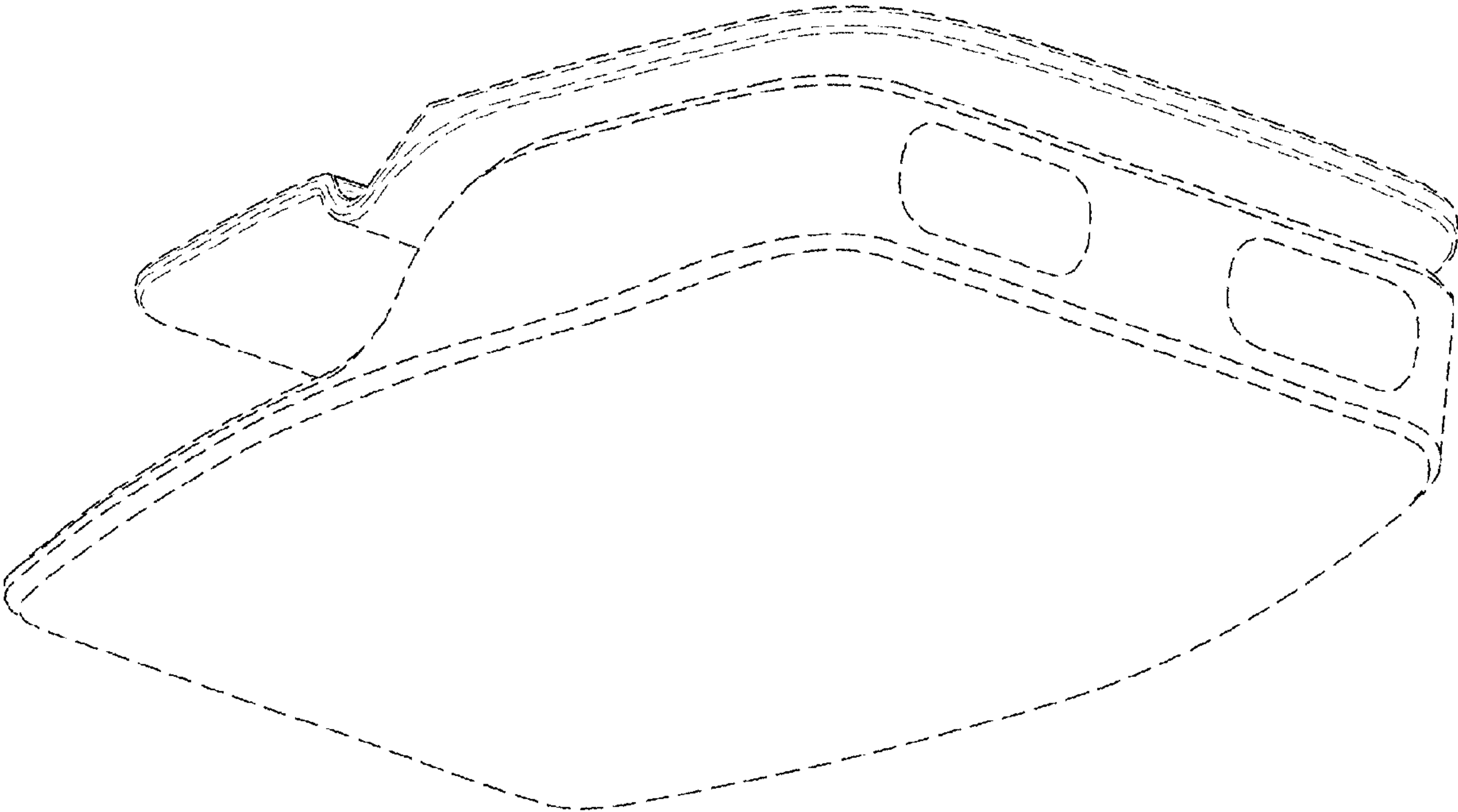

FIG. 11

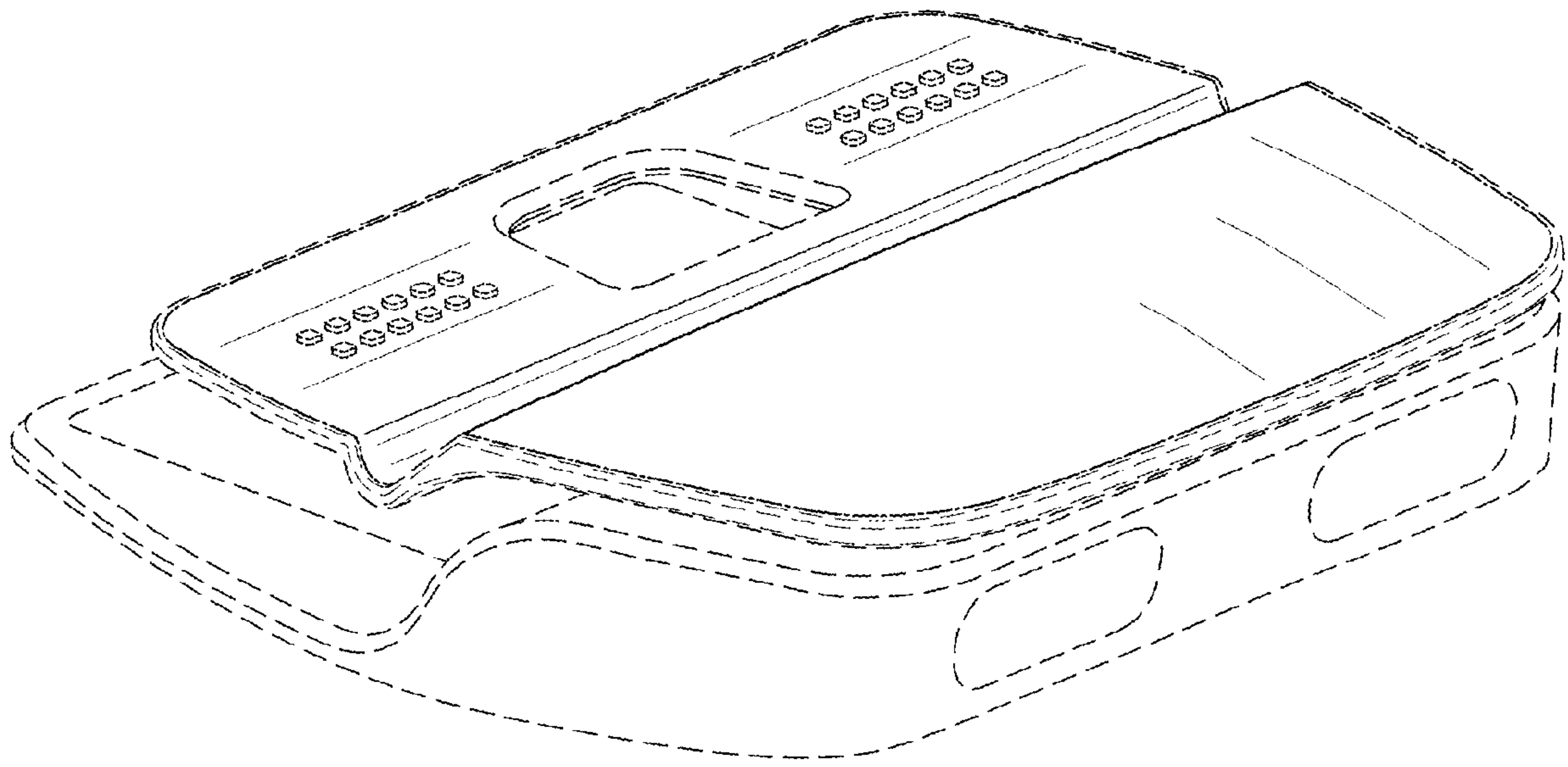

FIG. 12

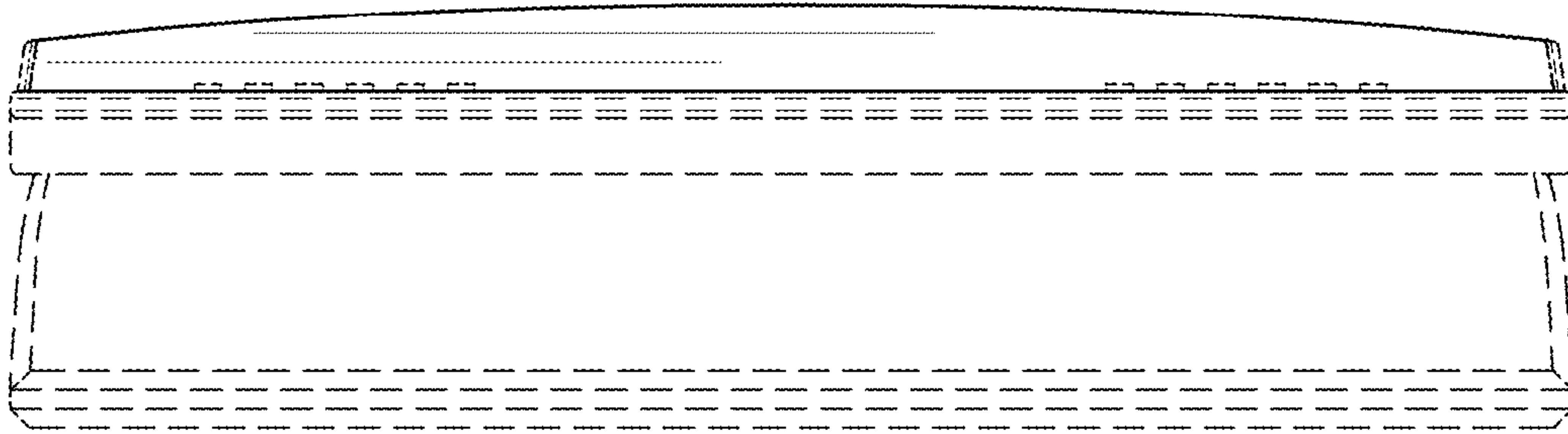

FIG. 13

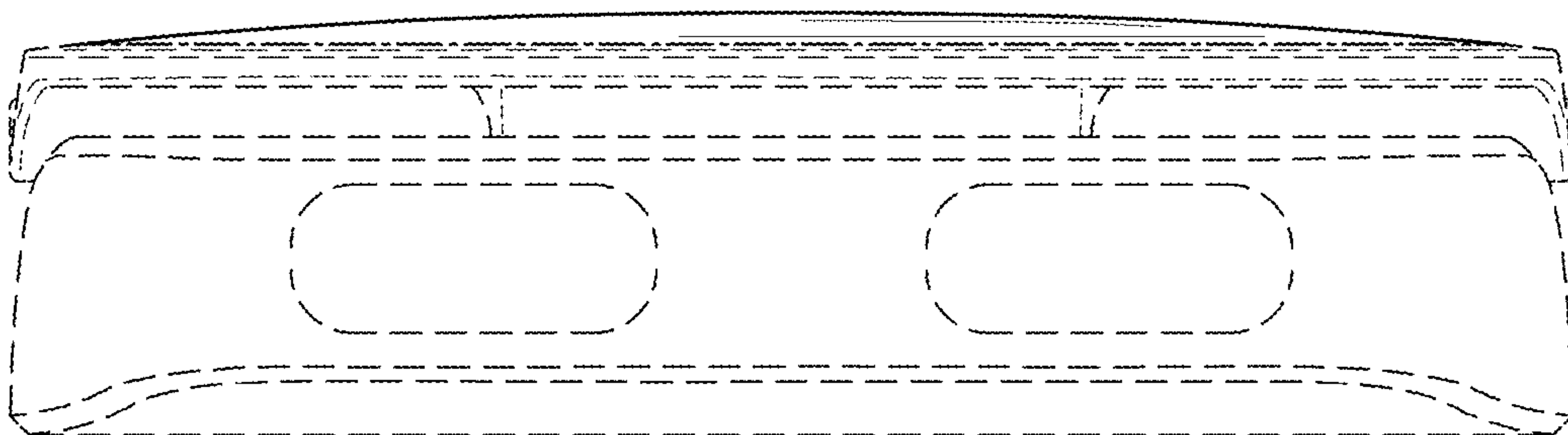

FIG. 14



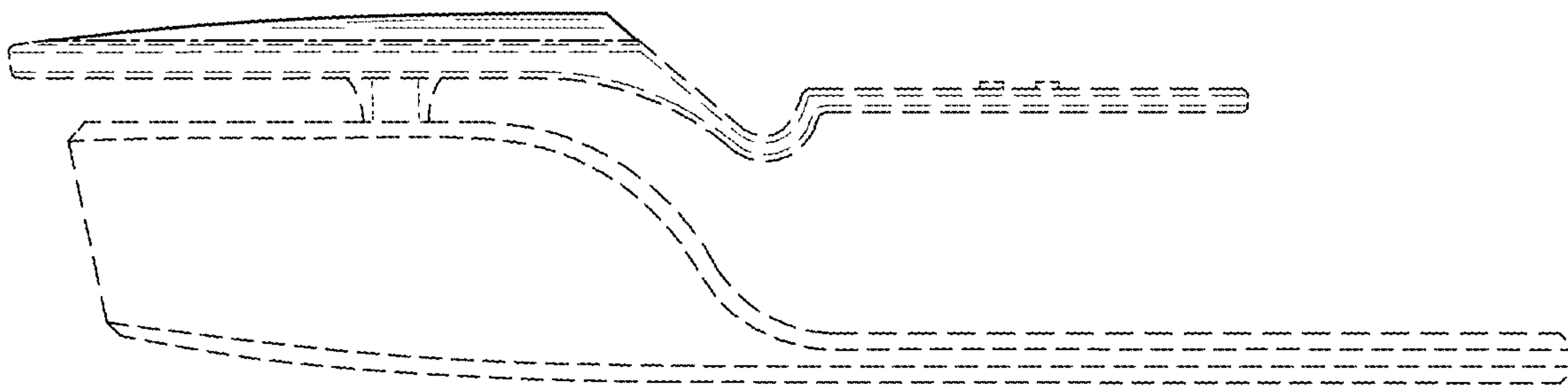

FIG. 15

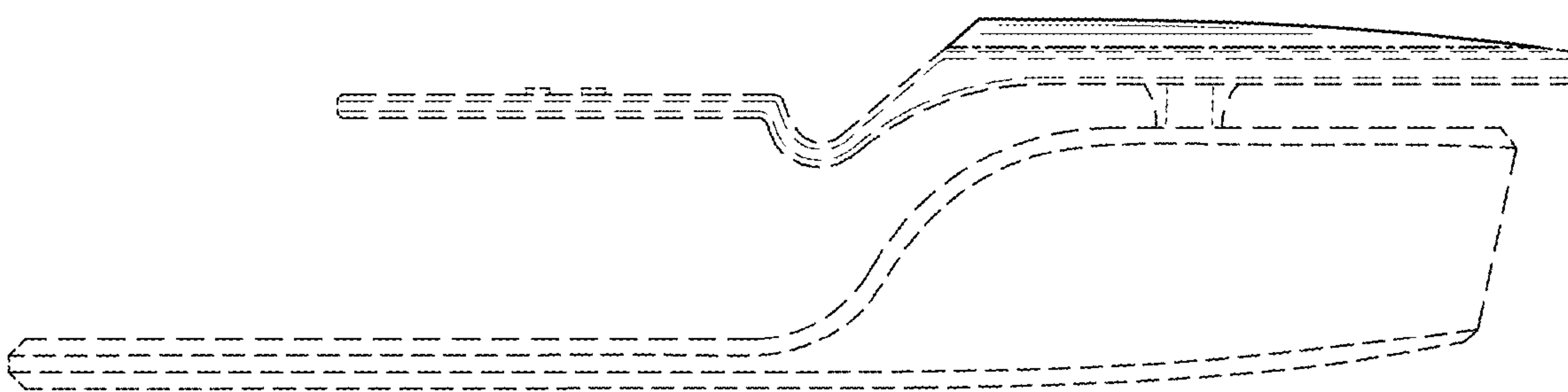

FIG. 16

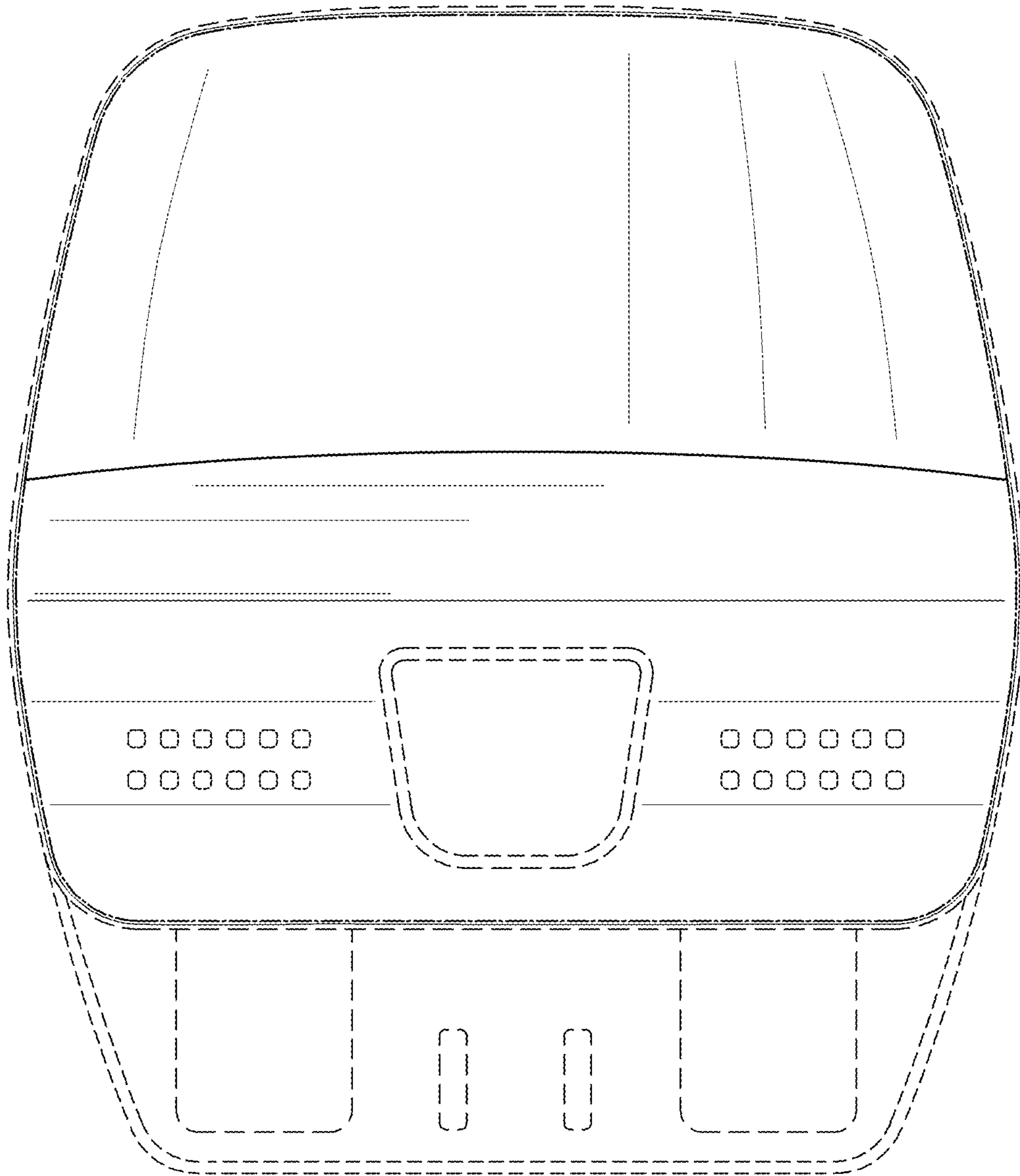

FIG. 17



FIG. 18

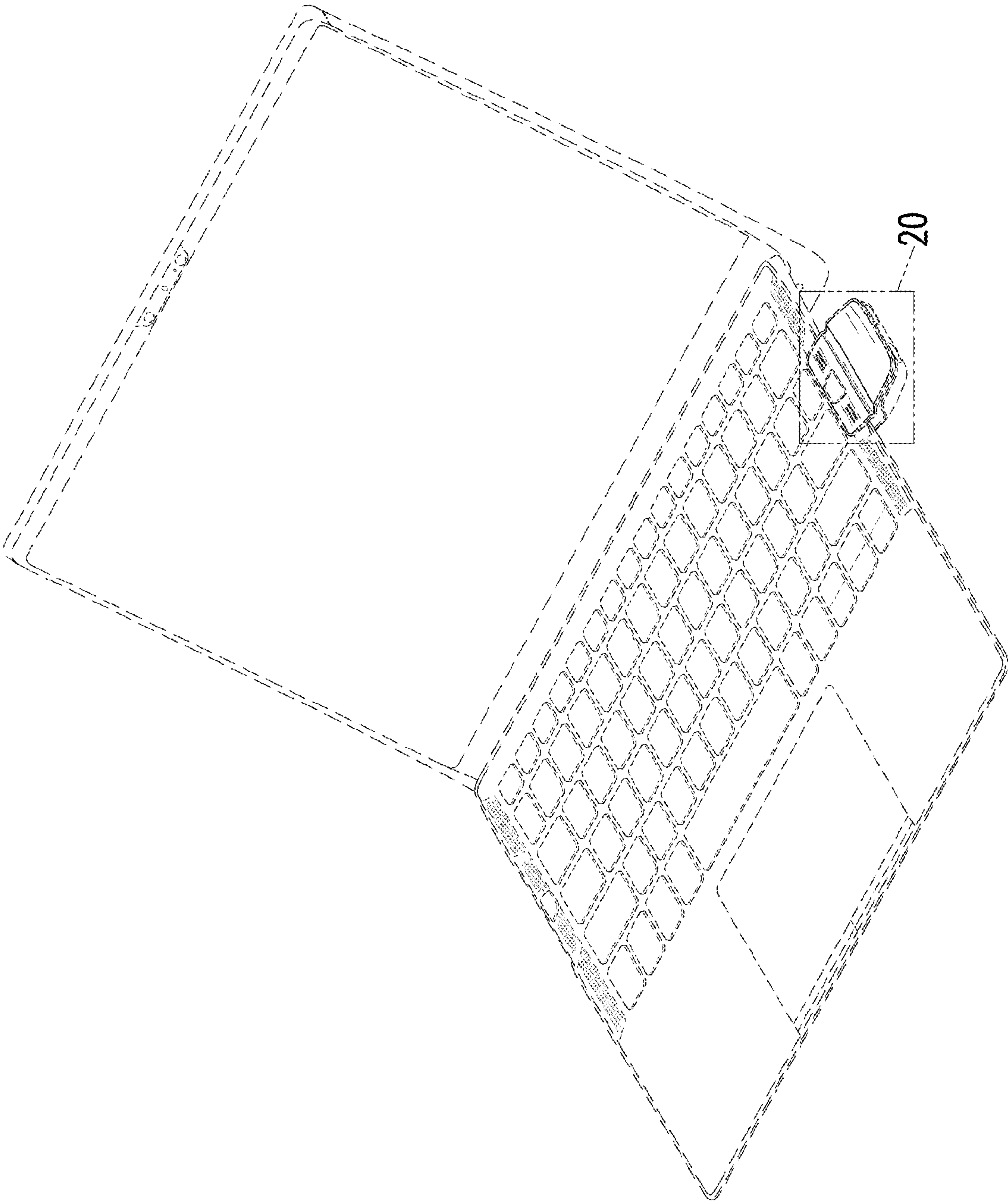

FIG. 19

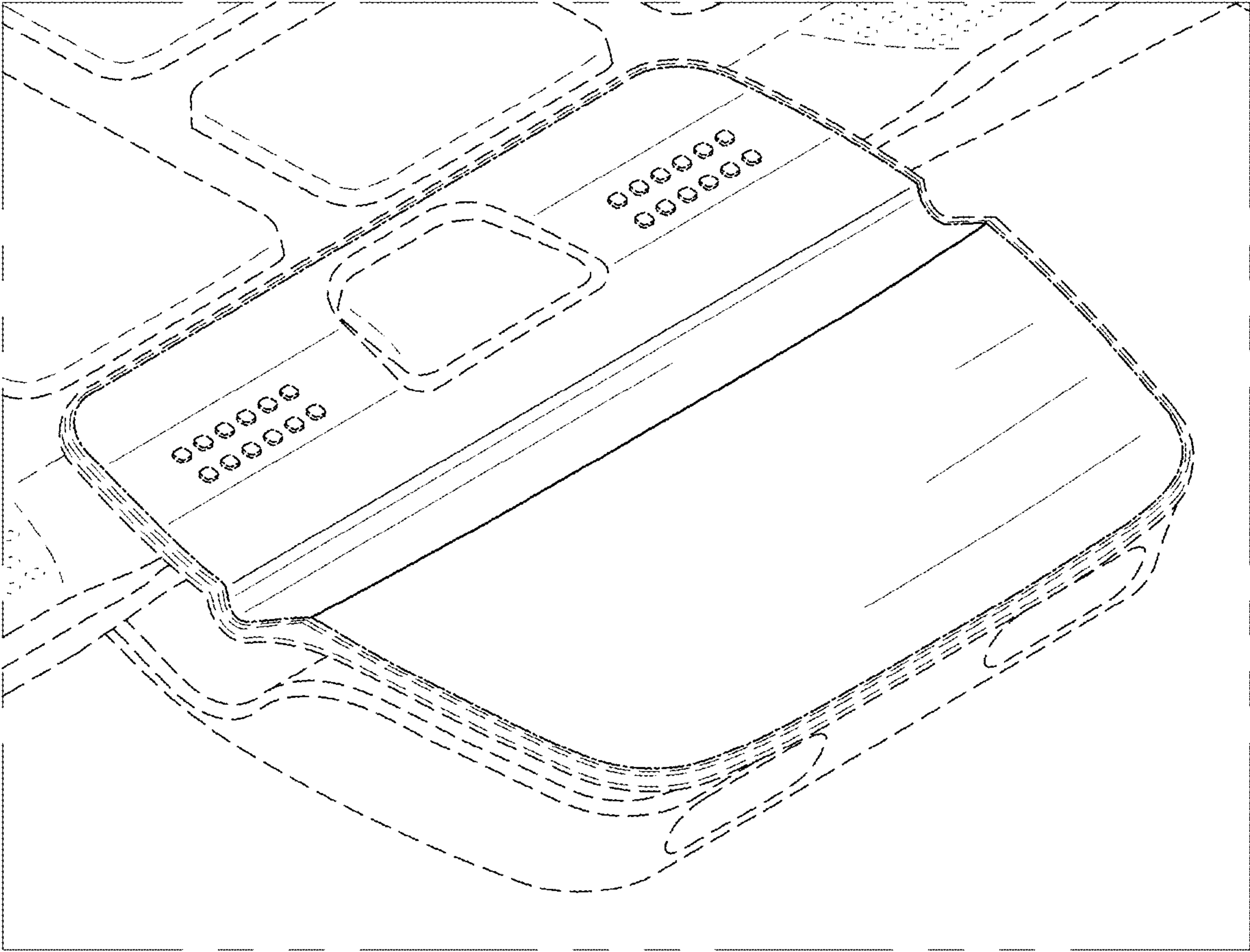

FIG. 20



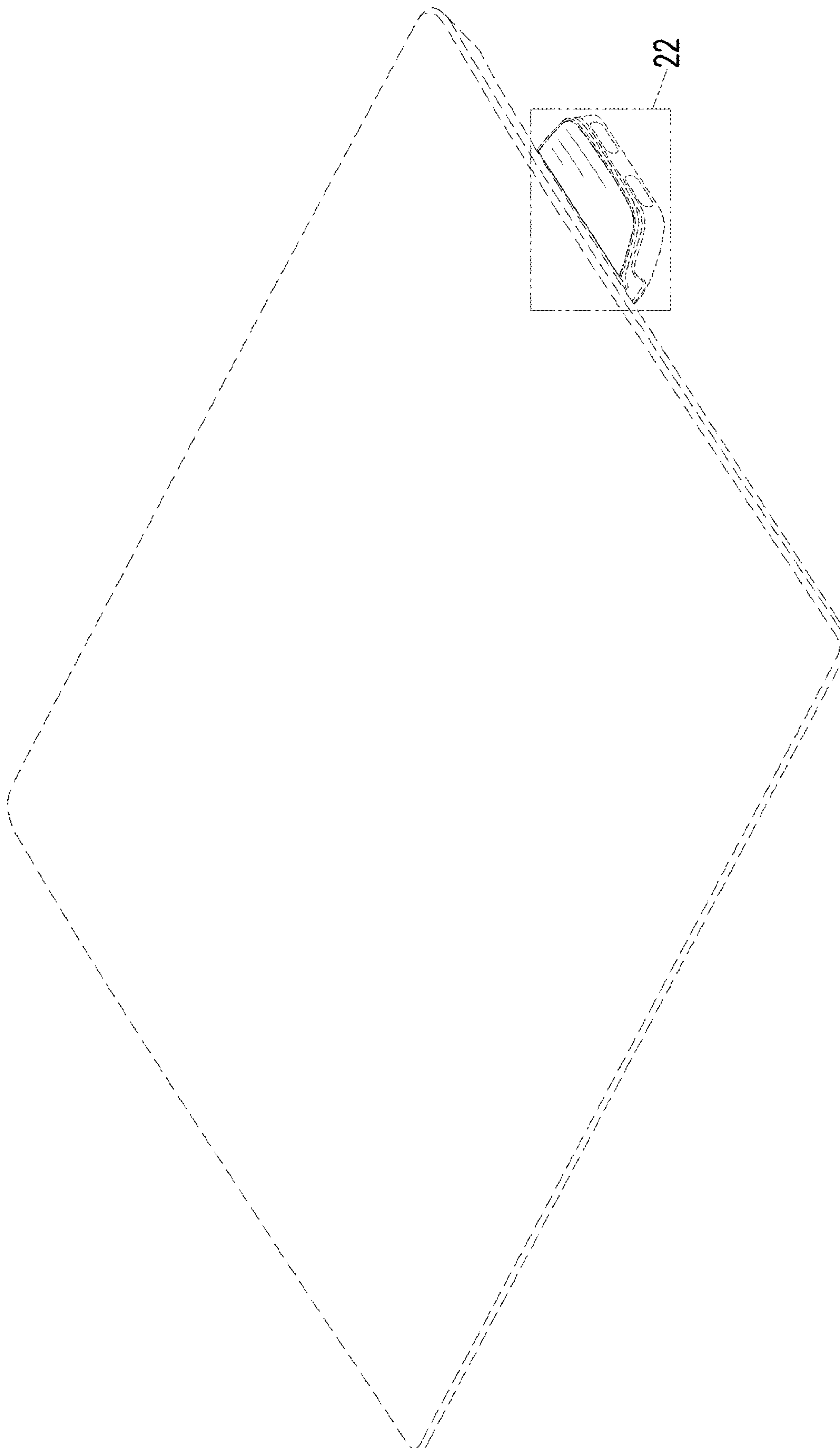

FIG. 21

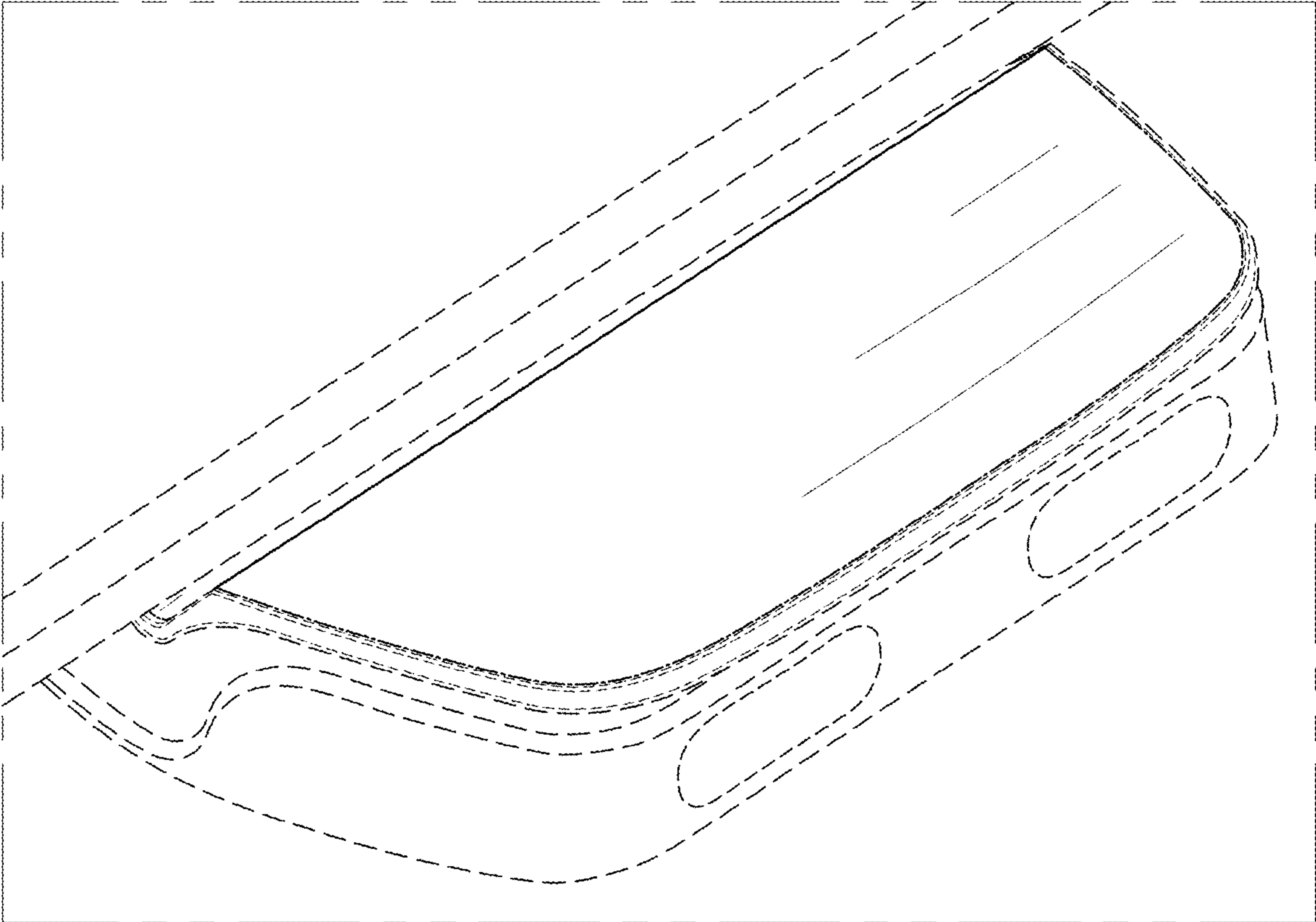

FIG. 22