



US00D885210S

(12) **United States Design Patent**
Siminoff et al.

(10) **Patent No.:** **US D885,210 S**
(45) **Date of Patent:** **** May 26, 2020**

- (54) **FLOOD AND FREEZE SENSOR**
- (71) Applicant: **AMAZON TECHNOLOGIES, INC.**,
Seattle, WA (US)
- (72) Inventors: **Mark Siminoff**, Mountain View, CA
(US); **Timothy G. Wellener**,
Phoenixville, PA (US); **Vinay Sao**,
Malvern, PA (US); **Peter Gerstberger**,
Laguna Niguel, CA (US); **Andrew L.**
Russell, Philadelphia, PA (US);
Christopher Loew, Palo Alto, CA (US)
- (73) Assignee: **Amazon Technologies, Inc.**, Seattle,
WA (US)
- (**) Term: **15 Years**
- (21) Appl. No.: **29/673,206**
- (22) Filed: **Dec. 12, 2018**
- (51) **LOC (12) Cl.** **10-01**
- (52) **U.S. Cl.**
USPC **D10/53; D10/56; D10/59; D10/101;**
D10/106.5
- (58) **Field of Classification Search**
USPC **D10/52, 53, 56, 57, 60, 101, 106.5**
(Continued)

(56) **References Cited**

U.S. PATENT DOCUMENTS

- 4,932,254 A * 6/1990 Davidson G01W 1/14
73/170.25
- 5,245,274 A * 9/1993 Youngquist G01W 1/16
324/202

(Continued)

Primary Examiner — Antoine Duval Davis

(74) *Attorney, Agent, or Firm* — Lathrop GPM LLP

(57) **CLAIM**

The ornamental design for a flood and freeze sensor, as shown and described.

DESCRIPTION

FIG. 1 is a front perspective view of the flood and freeze sensor according to a first embodiment of the present design;

FIG. 2 is a right-side elevational view of the flood and freeze sensor of FIG. 1;
 FIG. 3 is a left-side elevational view of the flood and freeze sensor of FIG. 1;
 FIG. 4 is a rear elevational view of the flood and freeze sensor of FIG. 1;
 FIG. 5 is a front elevational view of the flood and freeze sensor of FIG. 1;
 FIG. 6 is a top plan view of the flood and freeze sensor of FIG. 1;
 FIG. 7 is a bottom plan view of the flood and freeze sensor of FIG. 1;
 FIG. 8 is a front perspective view of the flood and freeze sensor according to a second embodiment of the present design;
 FIG. 9 is a right-side elevational view of the flood and freeze sensor of FIG. 8;
 FIG. 10 is a left-side elevational view of the flood and freeze sensor of FIG. 8;
 FIG. 11 is a rear elevational view of the flood and freeze sensor of FIG. 8;
 FIG. 12 is a front elevational view of the flood and freeze sensor of FIG. 8;
 FIG. 13 is a top plan view of the flood and freeze sensor of FIG. 8;
 FIG. 14 is a bottom plan view of the flood and freeze sensor of FIG. 8;
 FIG. 15 is a front perspective view of the flood and freeze sensor according to a third embodiment of the present design;
 FIG. 16 is a right-side elevational view of the flood and freeze sensor of FIG. 15;
 FIG. 17 is a left-side elevational view of the flood and freeze sensor of FIG. 15;
 FIG. 18 is a rear elevational view of the flood and freeze sensor of FIG. 15;
 FIG. 19 is a front elevational view of the flood and freeze sensor of FIG. 15;
 FIG. 20 is a top plan view of the flood and freeze sensor of FIG. 15; and,
 FIG. 21 is a bottom plan view of the flood and freeze sensor of FIG. 15.
 In the drawings, the broken lines depict environmental subject matter only and form no part of the claimed design.

1 Claim, 15 Drawing Sheets

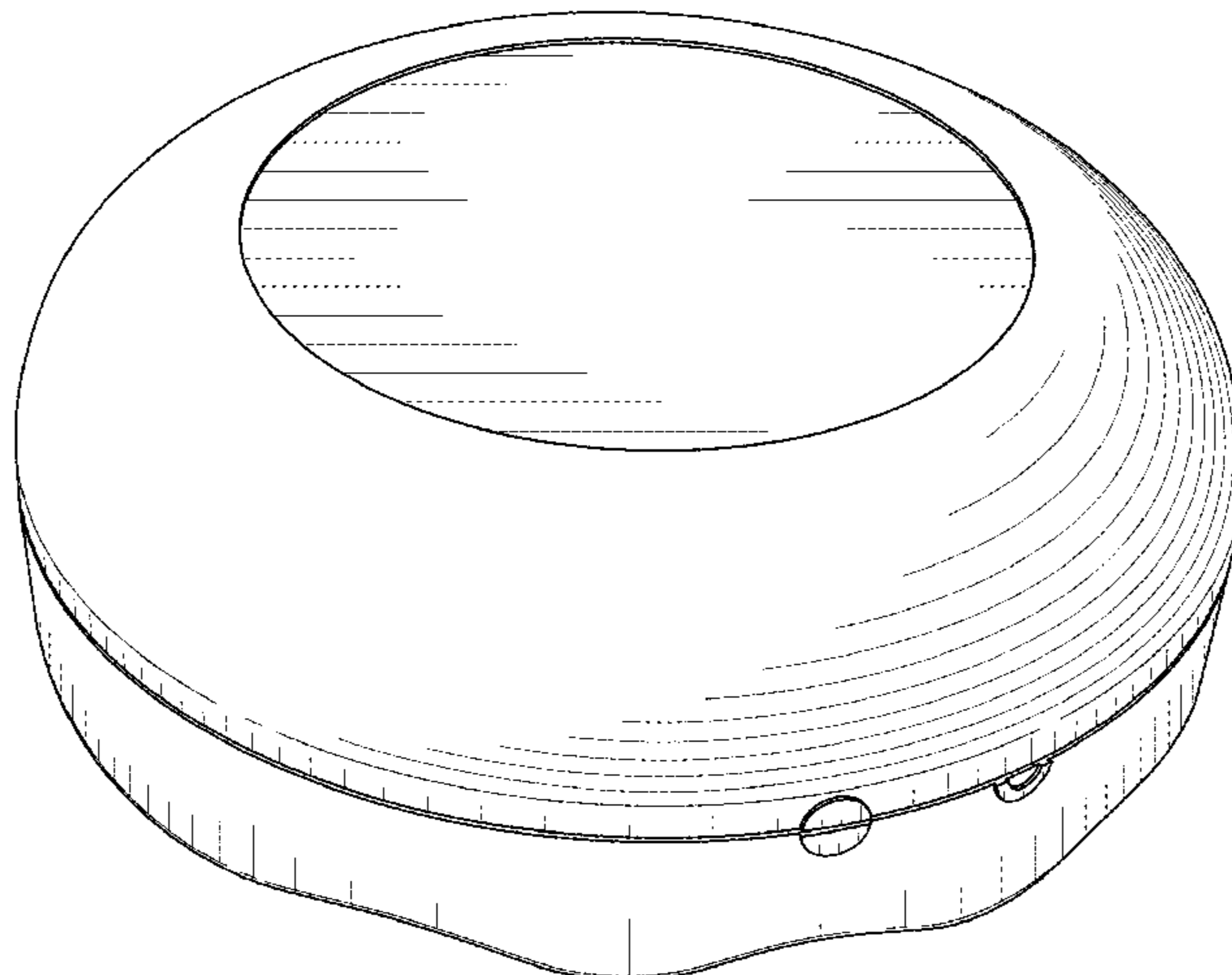

(58) **Field of Classification Search**

CPC G01W 1/00; G01W 2001/003; G01W
2001/006; G01W 1/02; G01W 1/04;
G01W 1/06; G01W 1/08; G01W 1/10;
G01W 1/11; G01W 1/12; G01W 1/14;
G01W 1/16; G01W 1/17; G01W 1/18

See application file for complete search history.

(56) **References Cited**

U.S. PATENT DOCUMENTS

D675,543 S *	2/2013	Brooking	D10/56
8,448,507 B2 *	5/2013	Salmi	G01W 1/14
			73/170.16
D705,098 S *	5/2014	Brooking	D10/56
D731,334 S *	6/2015	Fiedler	D10/70
D850,939 S *	6/2019	Siminoff	D10/53
D854,950 S *	7/2019	Seum	G01W 1/14
			D10/53
D856,169 S *	8/2019	Libson	G01W 1/16
			D10/49
D859,184 S *	9/2019	Meis	G01W 1/14
			D10/52

* cited by examiner

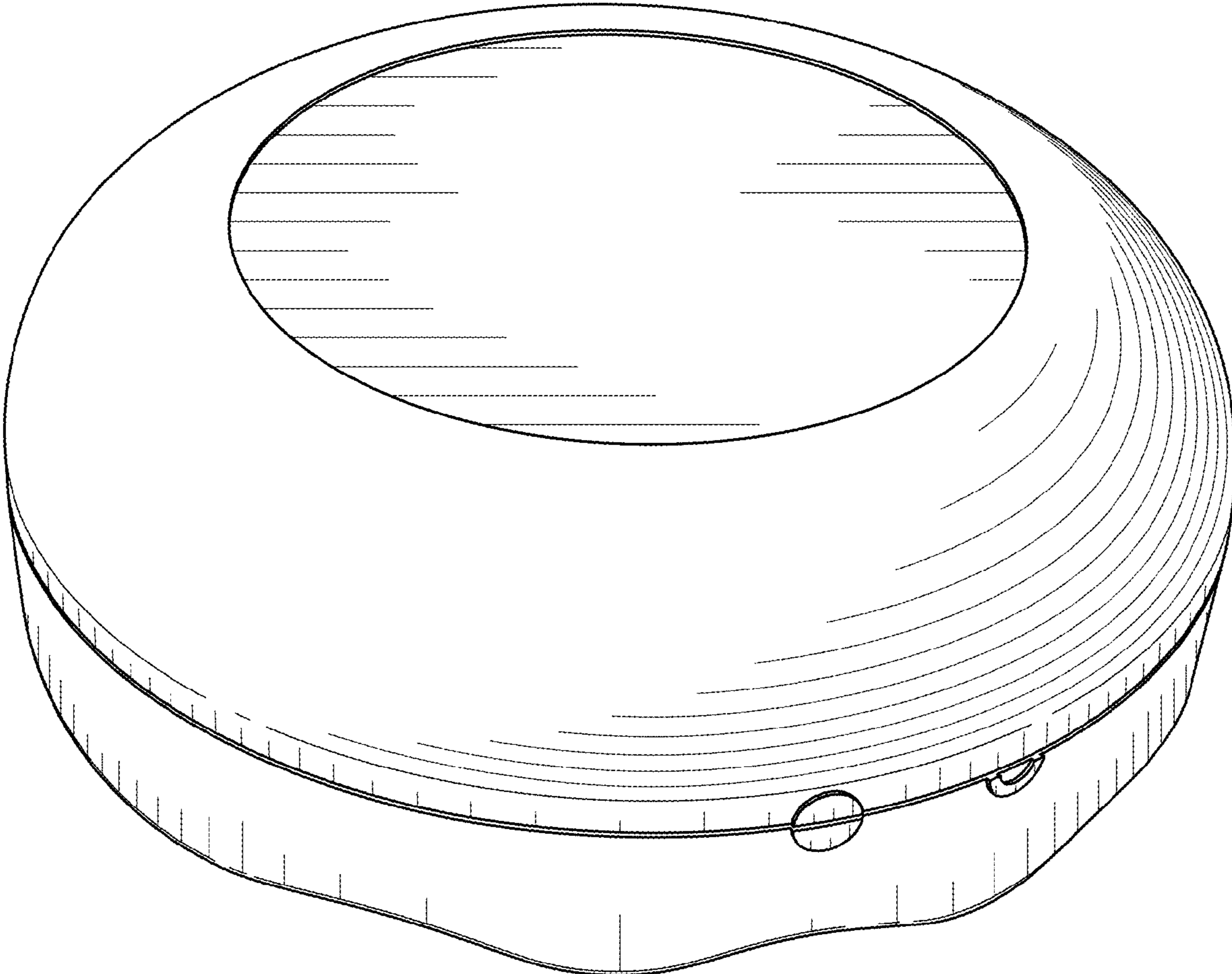

FIG. 1

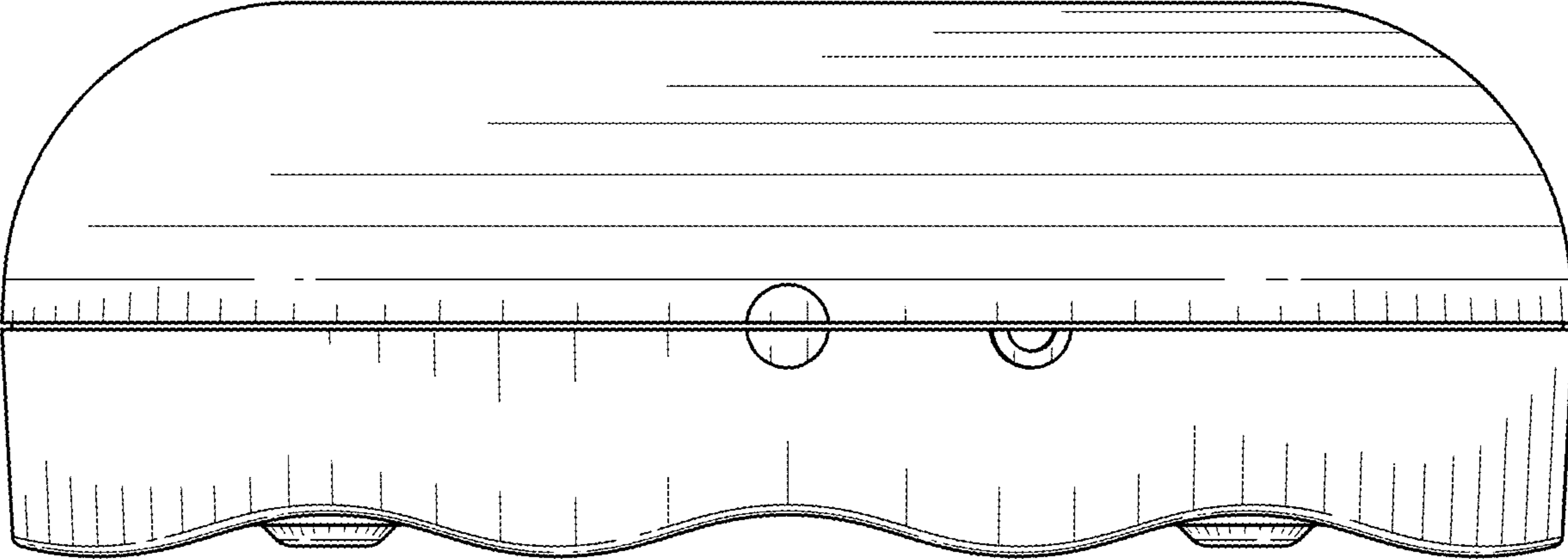

FIG. 2

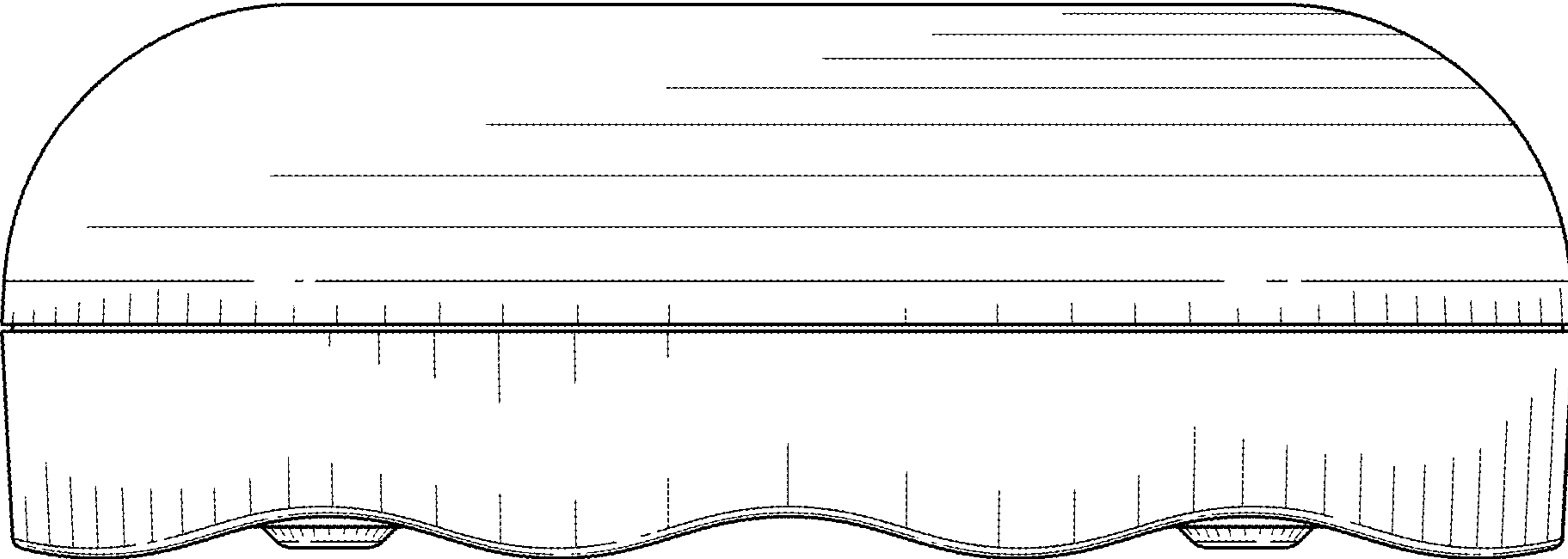

FIG. 3

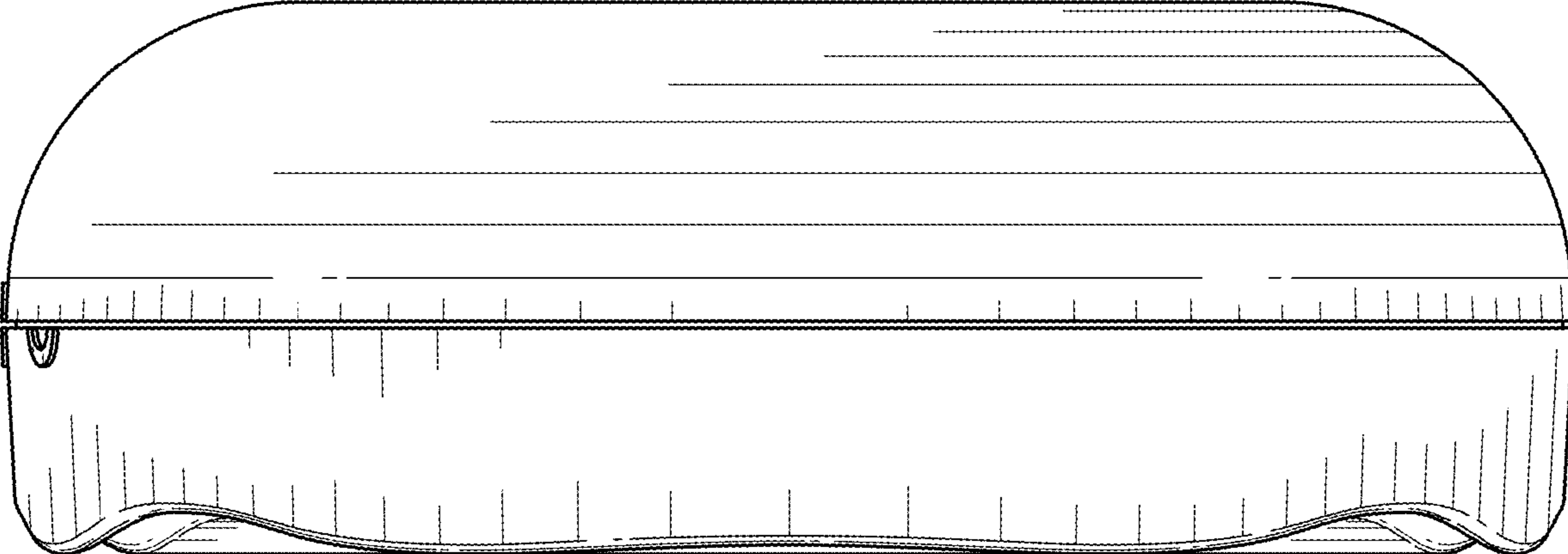

FIG. 4

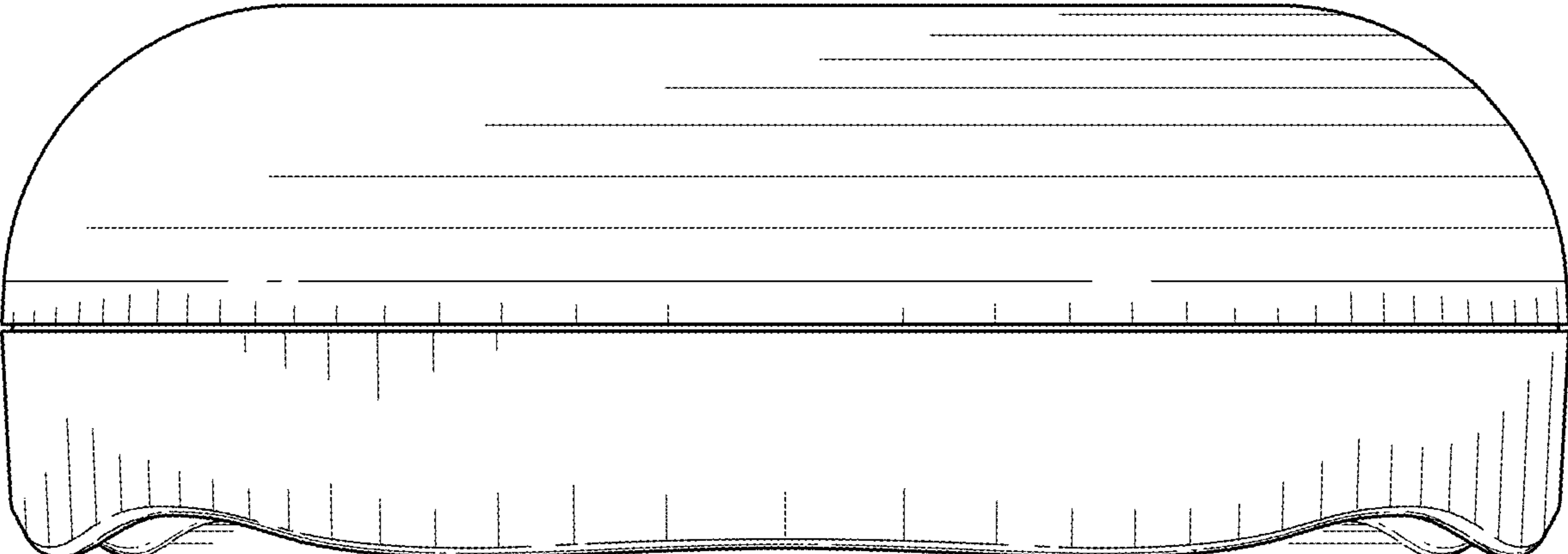

FIG. 5

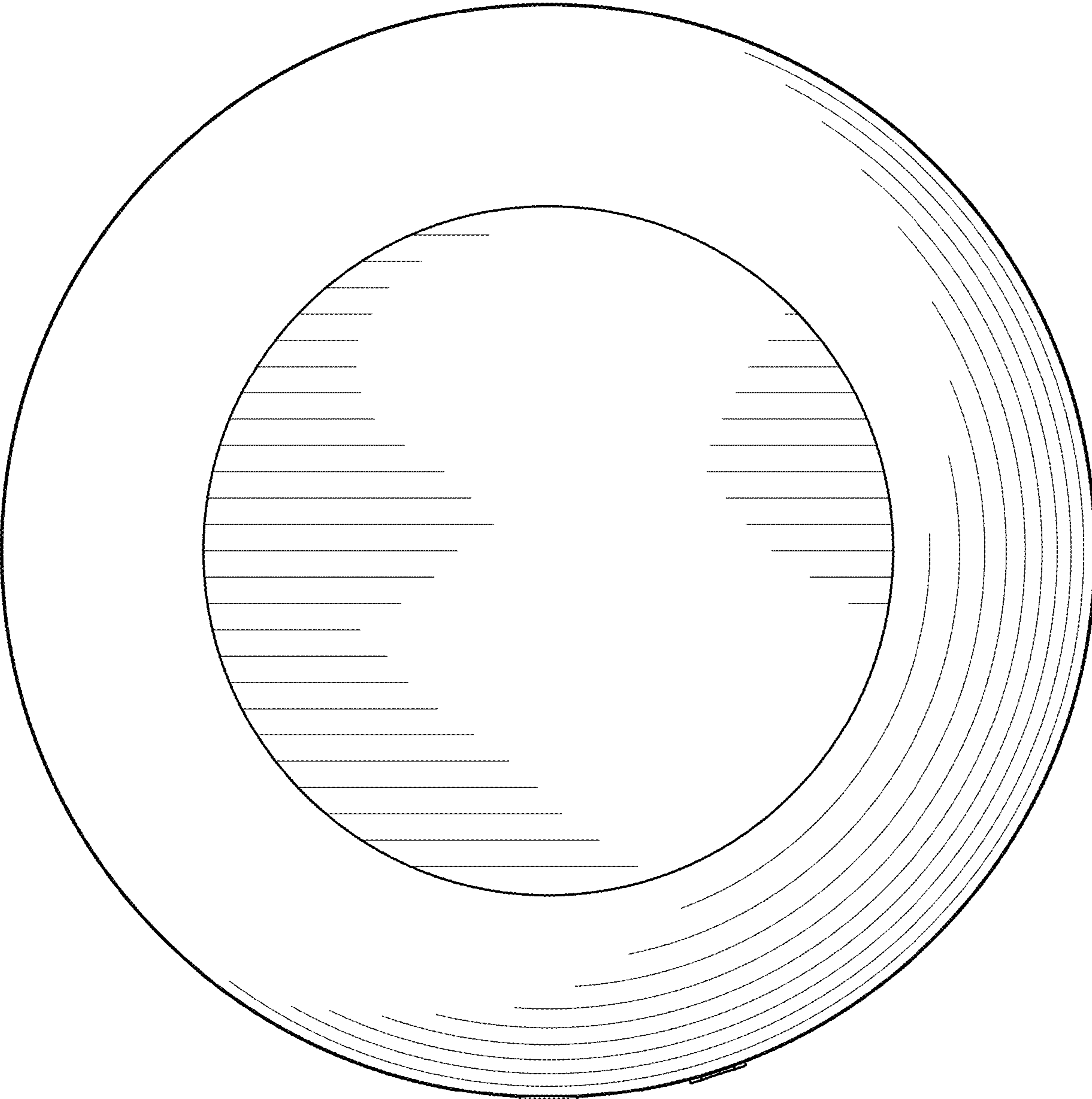

FIG. 6

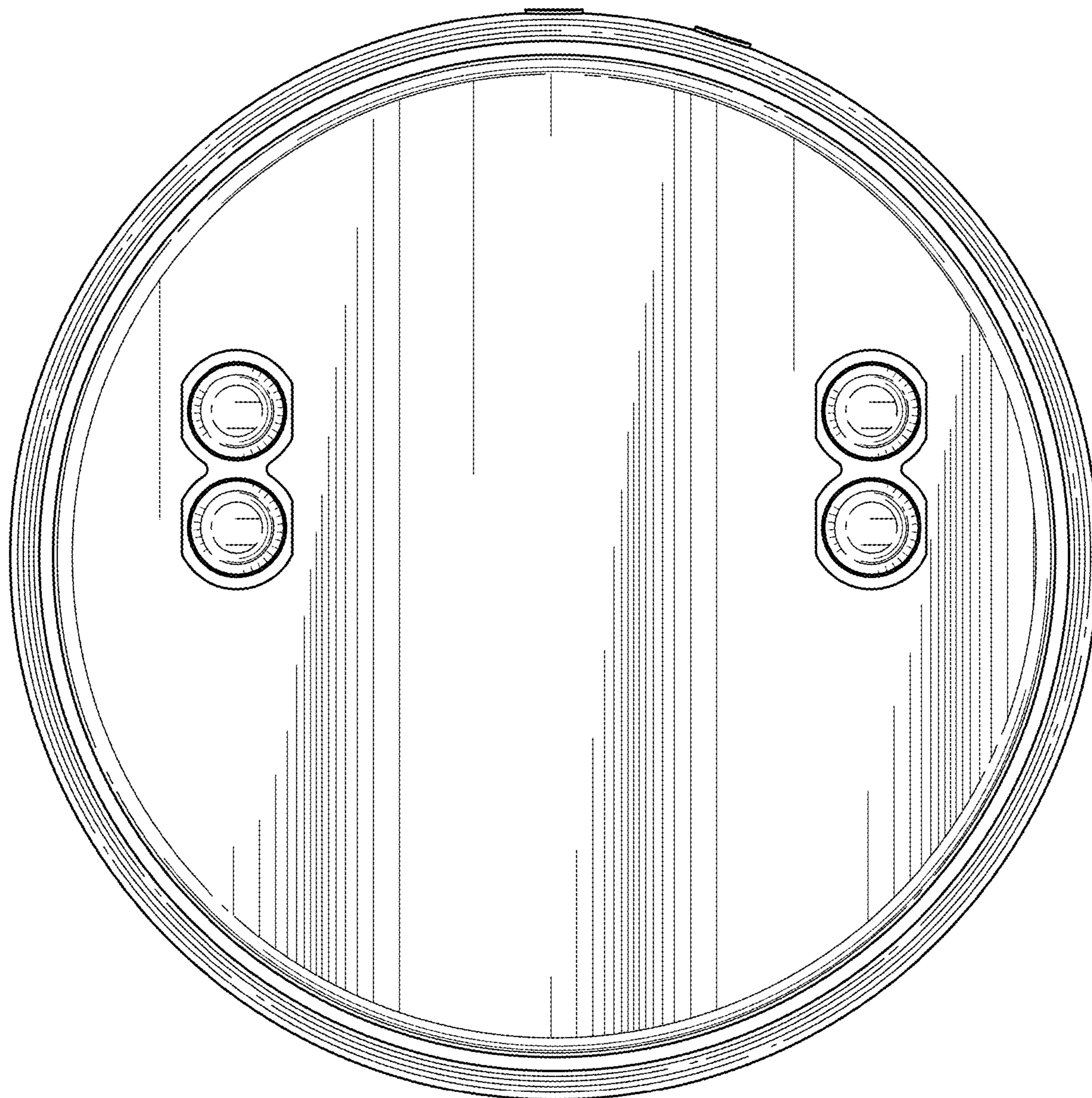

FIG. 7

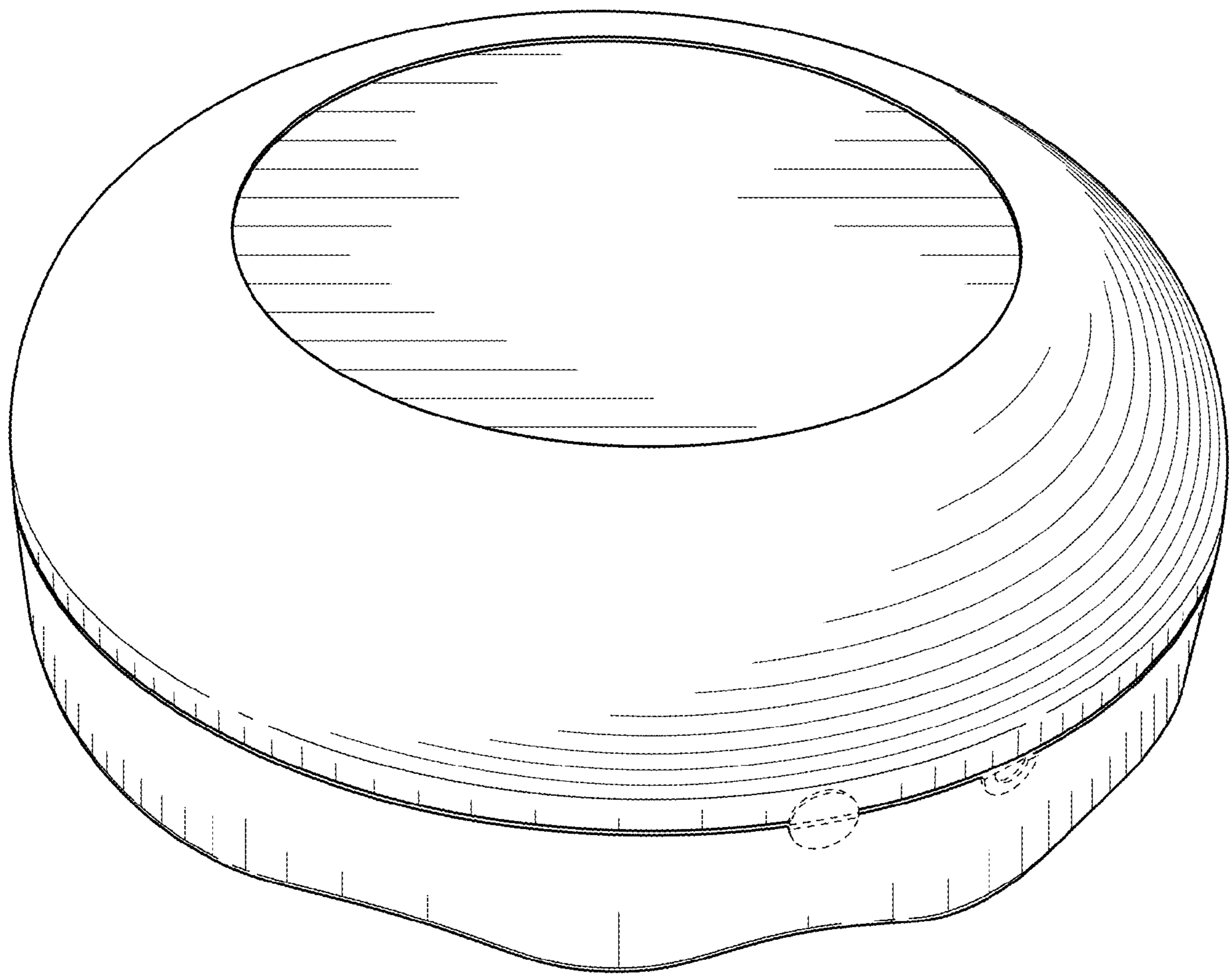

FIG. 8

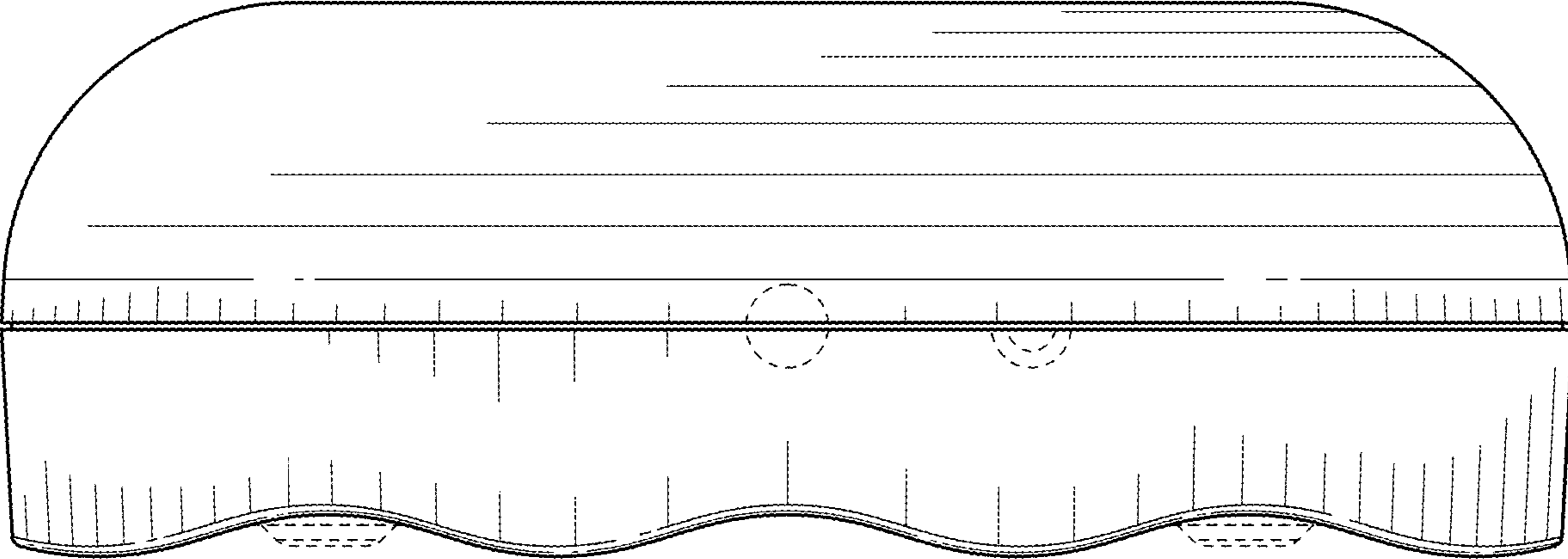

FIG. 9

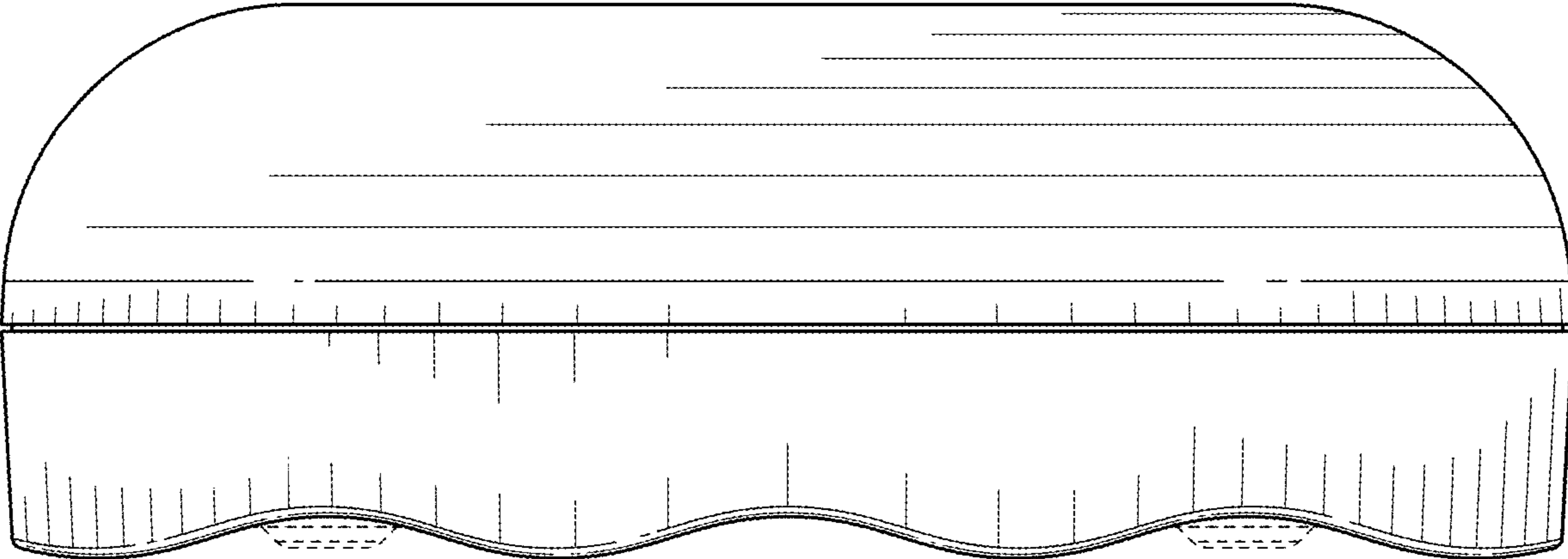

FIG. 10

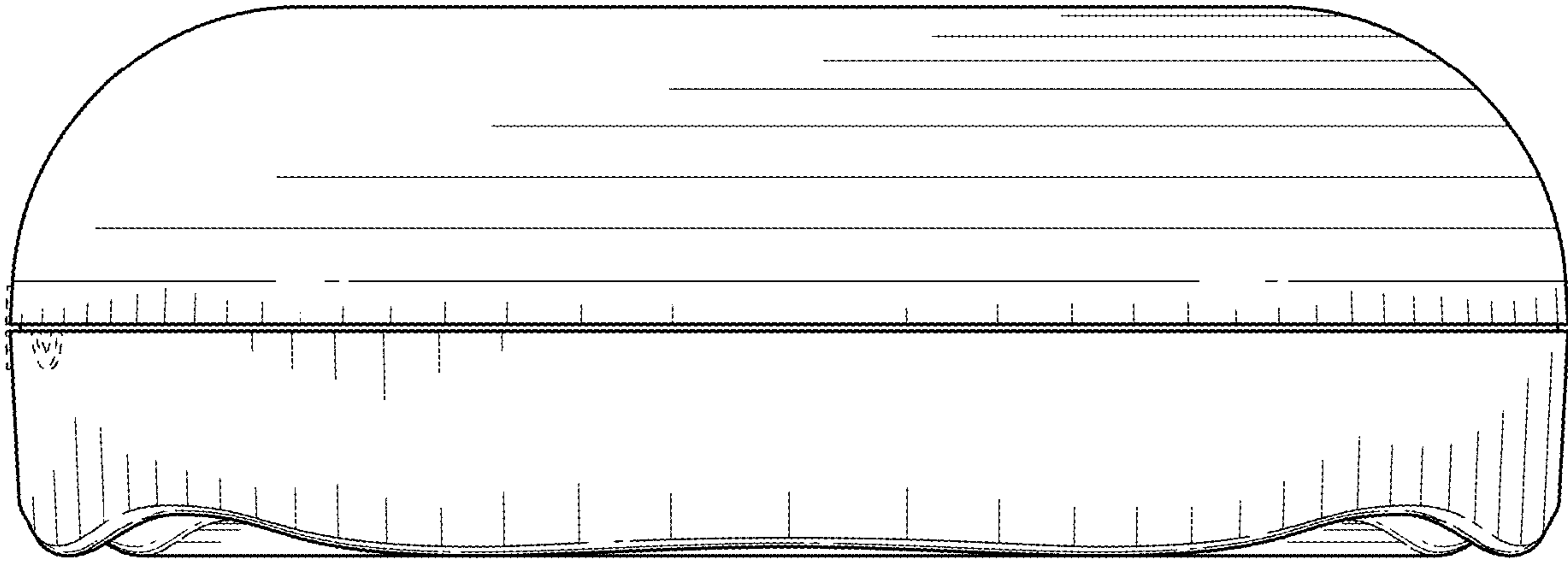

FIG. 11

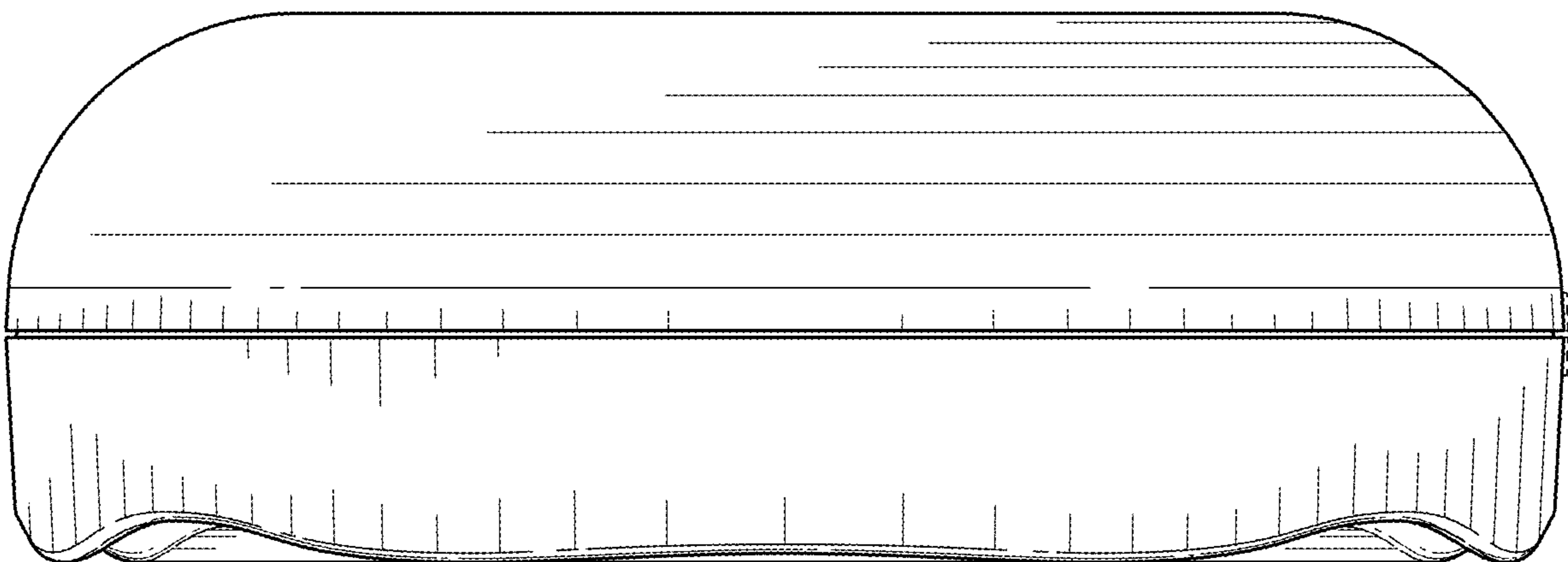

FIG. 12

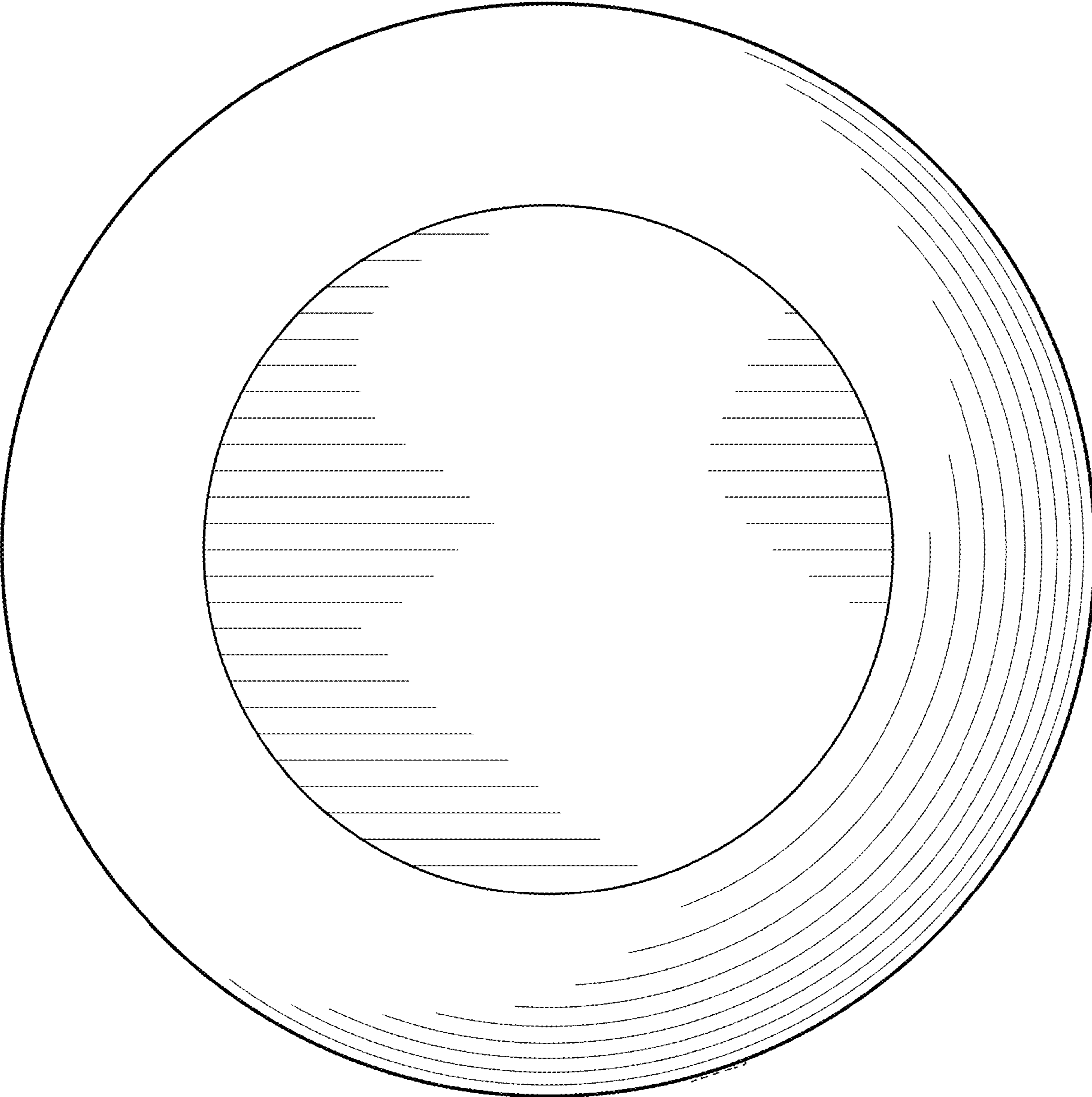

FIG. 13

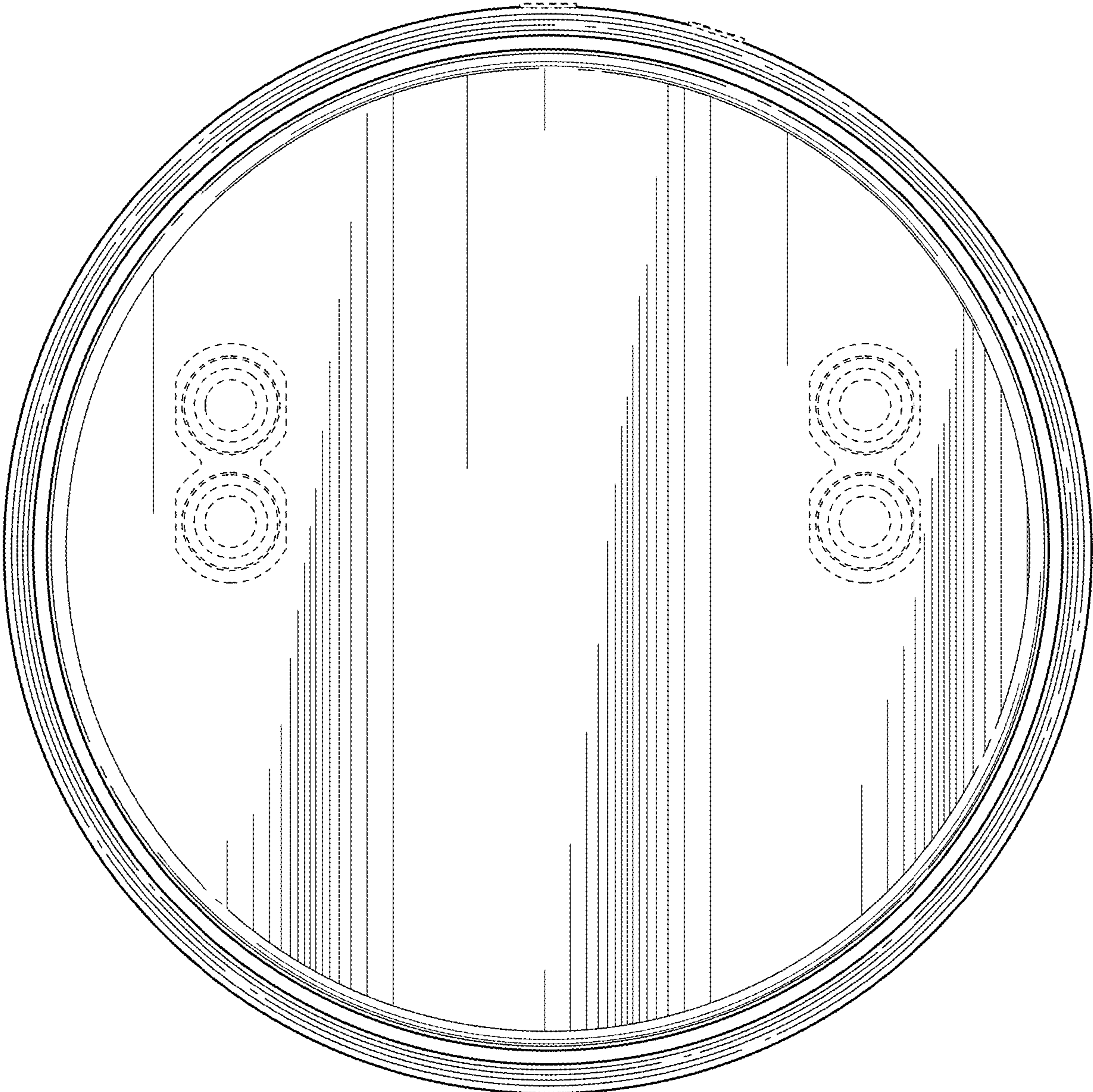

FIG. 14

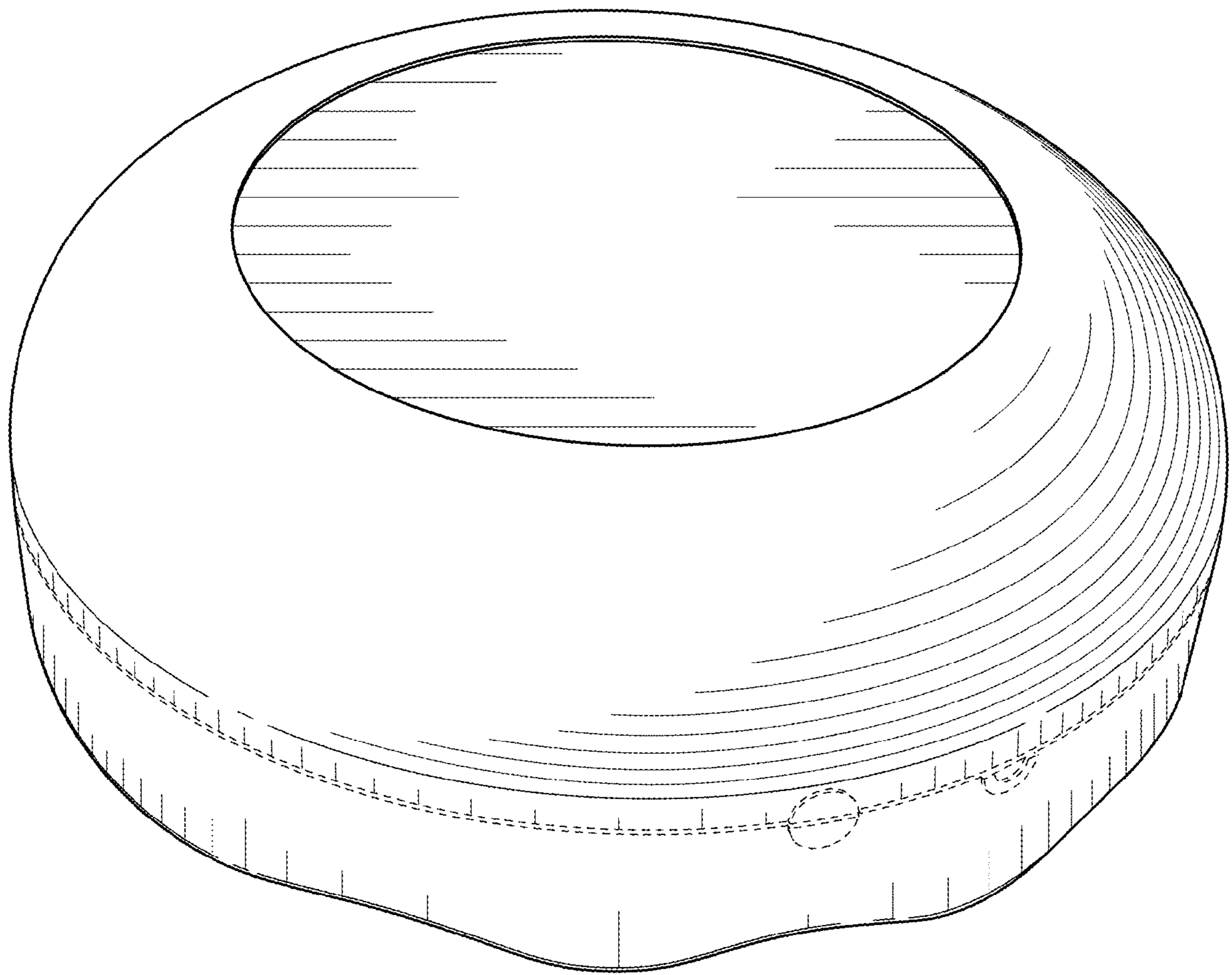

FIG. 15

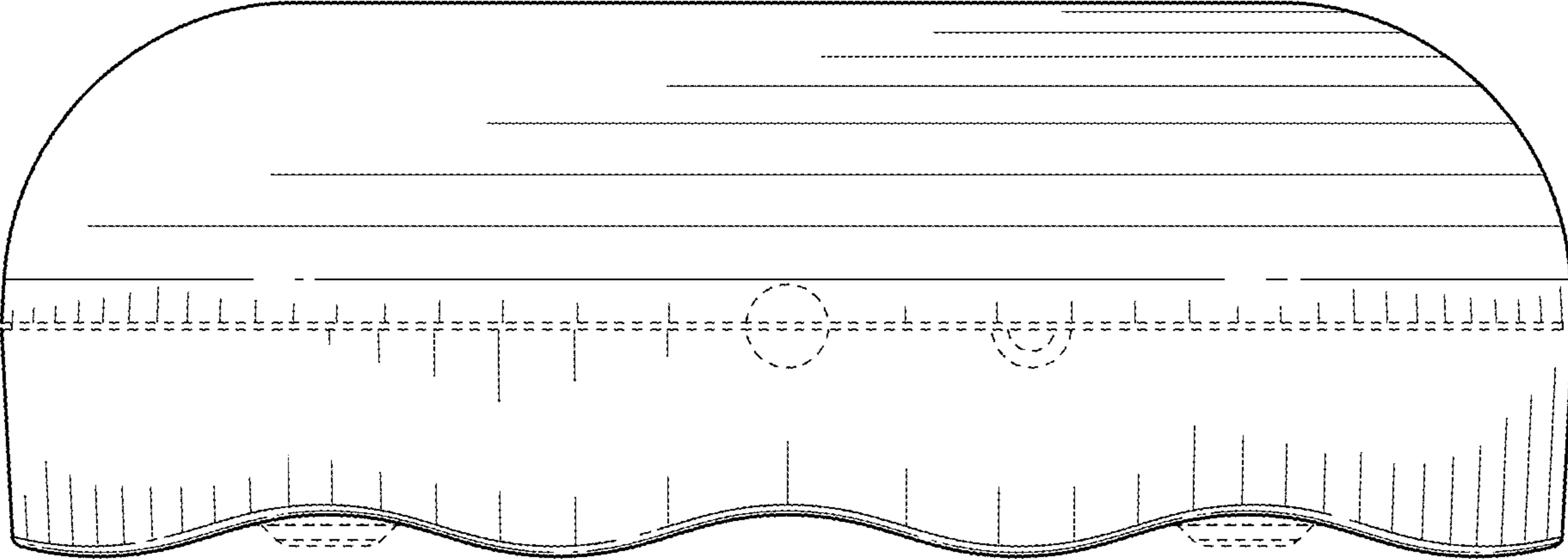

FIG. 16

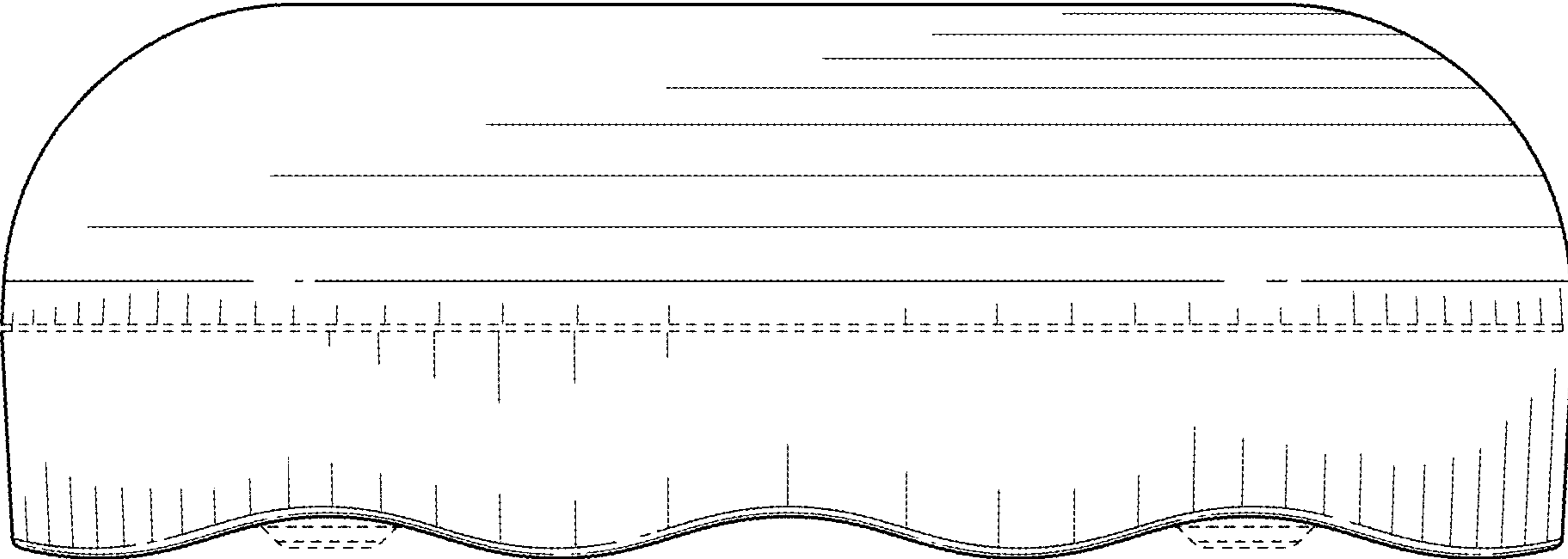

FIG. 17

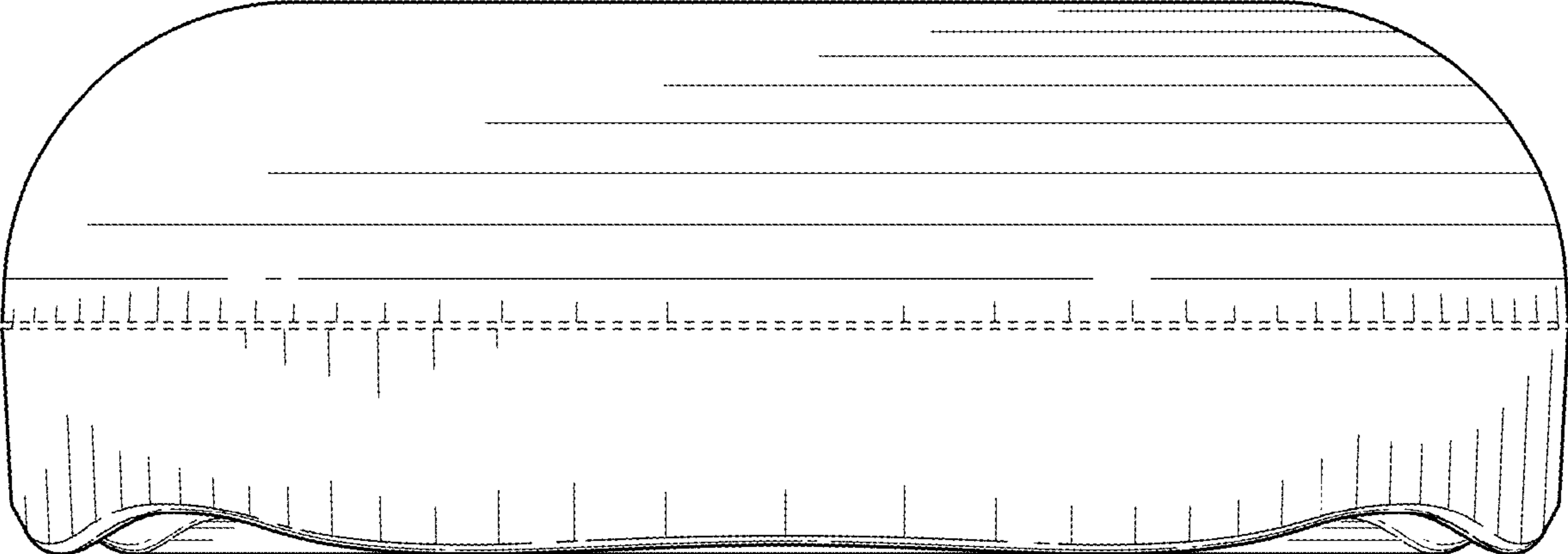

FIG. 18

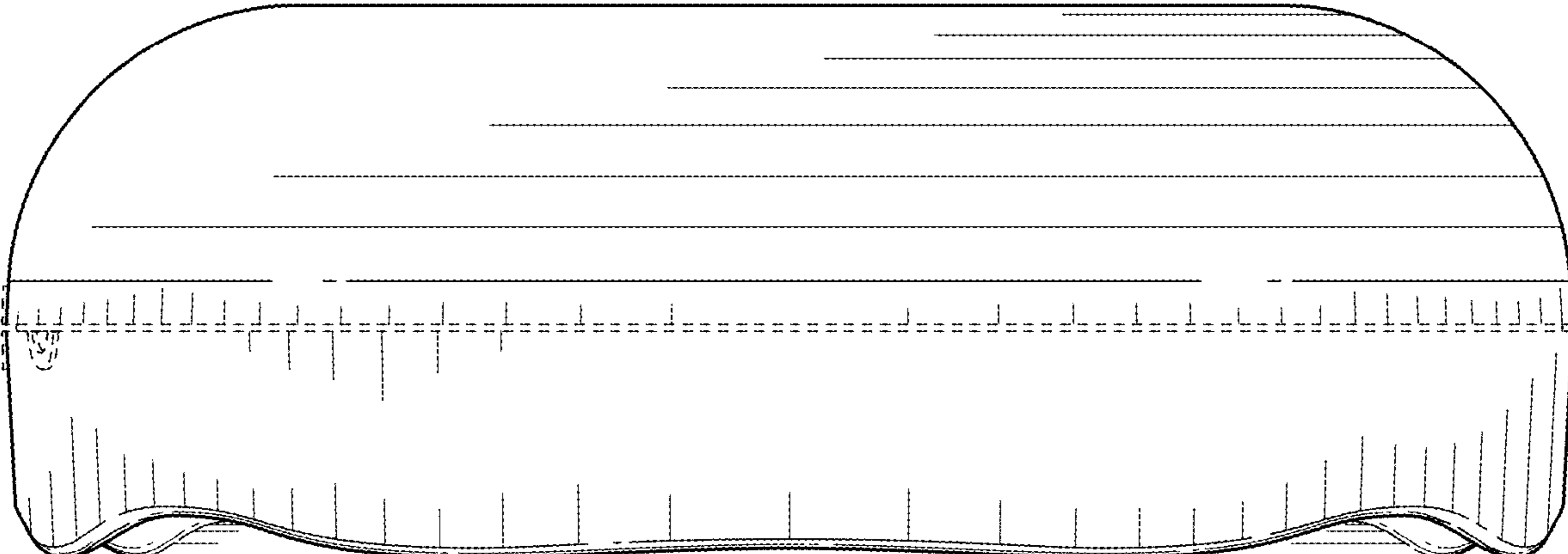

FIG. 19

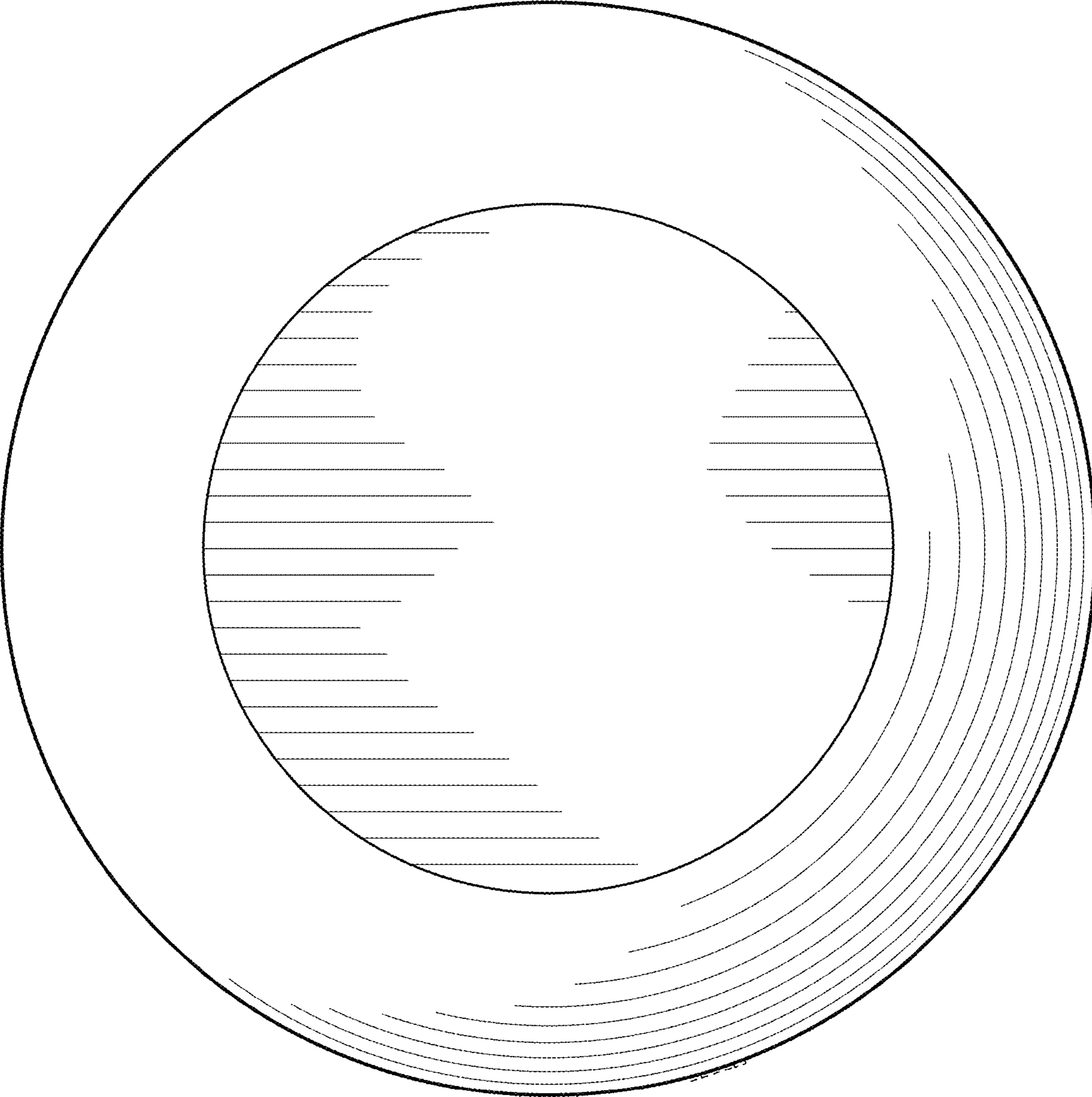

FIG. 20

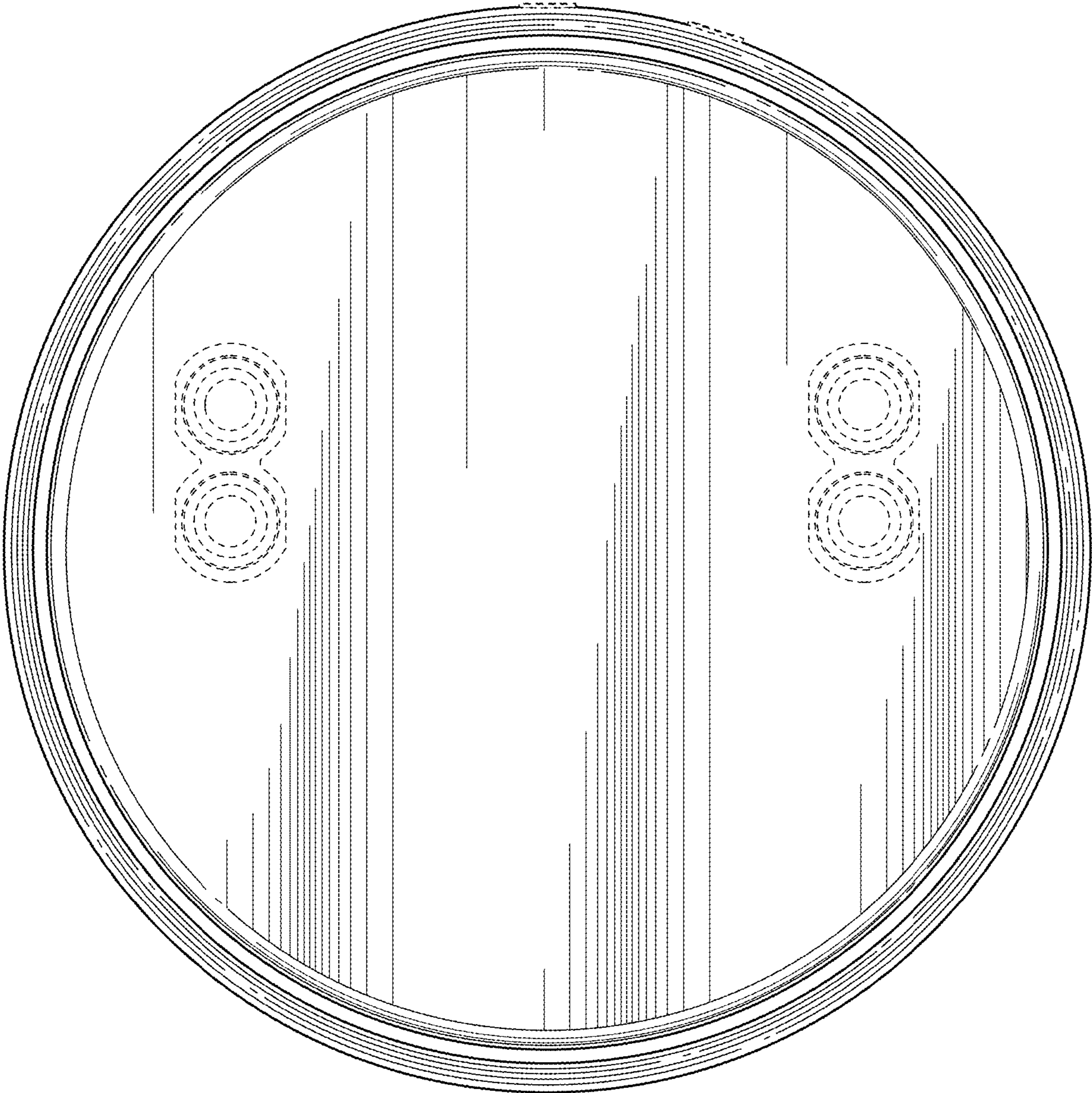

FIG. 21