



US00D885193S

(12) **United States Design Patent** (10) **Patent No.:** **US D885,193 S**
Vandenbos (45) **Date of Patent:** **** May 26, 2020**

(54) **SINGLE-SERVE CONTAINER WITH SURFACE ORNAMENTATION**

(71) Applicant: **Buzzbox Beverages, Inc.**, Palm Desert, CA (US)

(72) Inventor: **Rodney W. Vandenbos**, Palm Desert, CA (US)

(73) Assignee: **BUZZBOX BEVERAGES, INC.**, Palm Desert, CA (US)

(**) Term: **15 Years**

(21) Appl. No.: **29/673,827**

(22) Filed: **Dec. 18, 2018**

Related U.S. Application Data

(63) Continuation of application No. 29/612,876, filed on Aug. 4, 2017, now Pat. No. Des. 835,997.

(51) **LOC (12) Cl.** **09-01**

(52) **U.S. Cl.**
USPC **D9/600; D9/434**

(58) **Field of Classification Search**
USPC D3/270, 271.1–271.4; D9/600, 649, D9/414–434; 206/457, 459.5, 527; 215/381–384, 400; 229/116.1, 137, 140
CPC B65D 5/42; B65D 5/4208; B65D 81/30; B65D 81/60; B65D 81/365; B65D 81/366; B65D 81/368; B65D 2203/00; B65D 2203/02; B65D 67/00; B65D 5/75; B65D 71/16; B65D 71/20; B65D 5/08; B65D 5/065; A63H 81/16
See application file for complete search history.

(56) **References Cited**

U.S. PATENT DOCUMENTS

D140,559 S * 3/1945 Clark D9/600
4,294,362 A * 10/1981 Martensson B65D 5/065
229/140

(Continued)

OTHER PUBLICATIONS

Distillerista Buzzbox cocktail review, Jun. 24, 2016. <http://distillerista.com/buzz-boxes/>.*

Primary Examiner — Sandra L Morris

(74) *Attorney, Agent, or Firm* — Barnes & Thornburg LLP

(57) **CLAIM**

I claim the ornamental design for a single-serve container with surface ornamentation, as shown and described.

DESCRIPTION

FIG. 1 is a perspective view of a single-serve container with surface ornamentation in its blank, unassembled condition.

FIG. 2 is a top view of the single-serve container of FIG. 1.

FIG. 3 is a perspective view of the single-serve container of FIG. 1, showing the container in a constructed state.

FIG. 4 is a front view of the single-serve container of FIG. 3.

FIG. 5 is a rear view of the single-serve container of FIG. 3.

FIG. 6 is a left side view of the single-serve container of FIG. 3.

FIG. 7 is a right side view of the single-serve container of FIG. 3.

FIG. 8 is a top view of the single-serve container of FIG. 3; and,

FIG. 9 is a bottom view of the single-serve container of FIG. 3.

Features shown in broken or dotted lines in the drawings are not part of the claim. Also, any shading presented in the accompanying drawings is provided merely to highlight the contour of the invention and is not intended to be illustrative of texture or gloss.

1 Claim, 4 Drawing Sheets

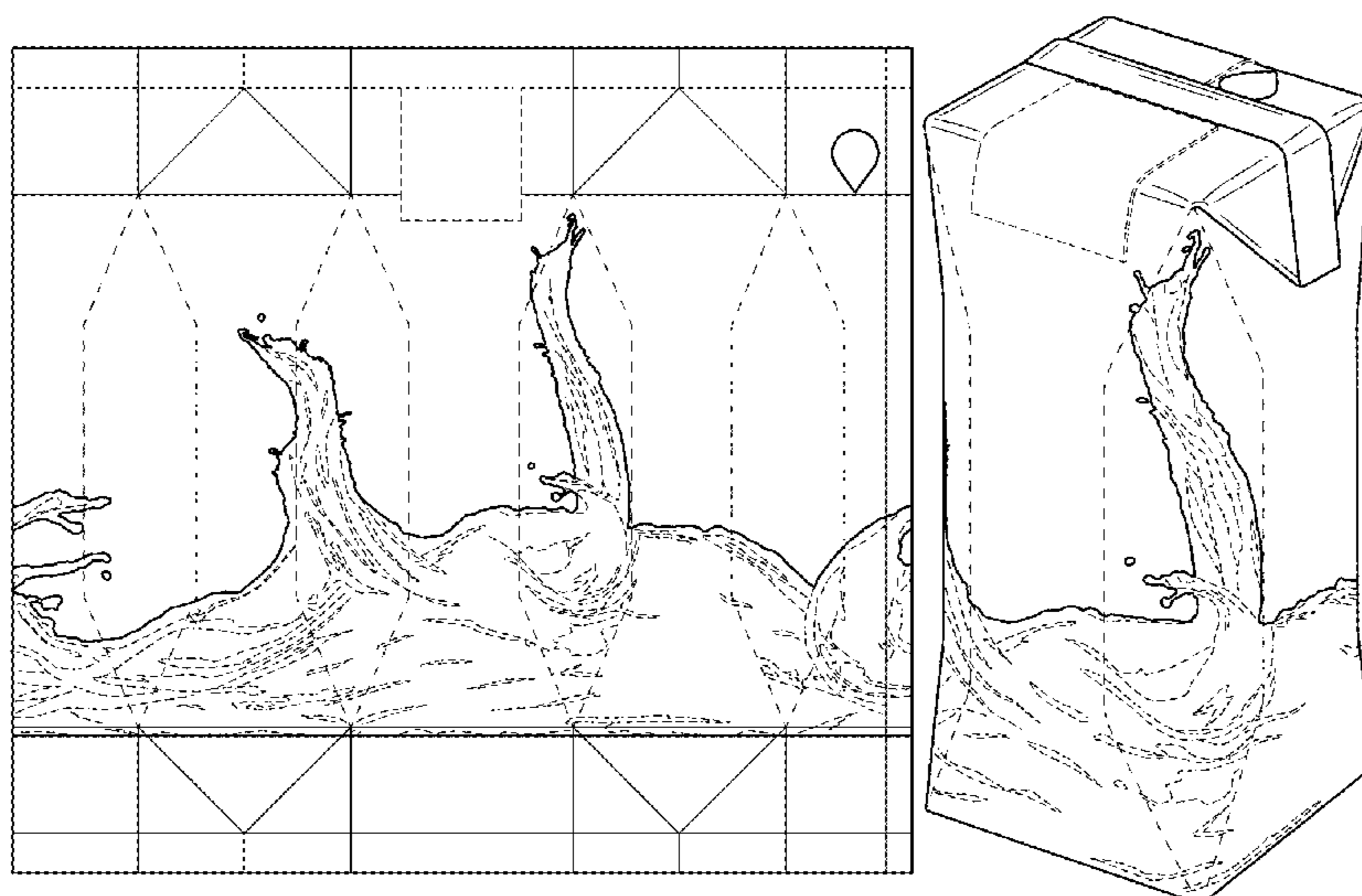

(56)

References Cited

U.S. PATENT DOCUMENTS

4,343,402 A * 8/1982 Holmstrom B65D 5/065
229/216
D281,668 S * 12/1985 Berard D9/416
5,474,232 A * 12/1995 Ljungstrom B65D 5/067
229/137
D464,566 S * 10/2002 Anchor D9/432
D494,861 S * 8/2004 Guidotti D9/431
D558,058 S * 12/2007 Raso D9/600
D617,386 S * 6/2010 Heinke D20/20
D617,843 S * 6/2010 Heinke D20/23
D621,275 S * 8/2010 Marotti D9/600
D634,625 S * 3/2011 Wallace D9/433
D635,018 S * 3/2011 Wallace D9/433
D656,837 S * 4/2012 Lanz D9/434
D677,335 S * 3/2013 Murphy D20/23
D691,882 S * 10/2013 Barbieri D9/430
D714,638 S * 10/2014 Mohn D9/432
D715,640 S * 10/2014 Okezawa B65D 5/067
D9/430
D721,576 S * 1/2015 De Pietri Tonelli D9/431
D733,556 S * 7/2015 De Pietri Tonelli ... B65D 5/065
D9/431
D748,470 S * 2/2016 Mohn B65D 5/065
D9/432
D764,283 S * 8/2016 Mohn D9/432
D835,997 S * 12/2018 Vandenbos D9/600
D835,998 S * 12/2018 Vandenbos D9/600
D835,999 S * 12/2018 Vandenbos D9/600

* cited by examiner

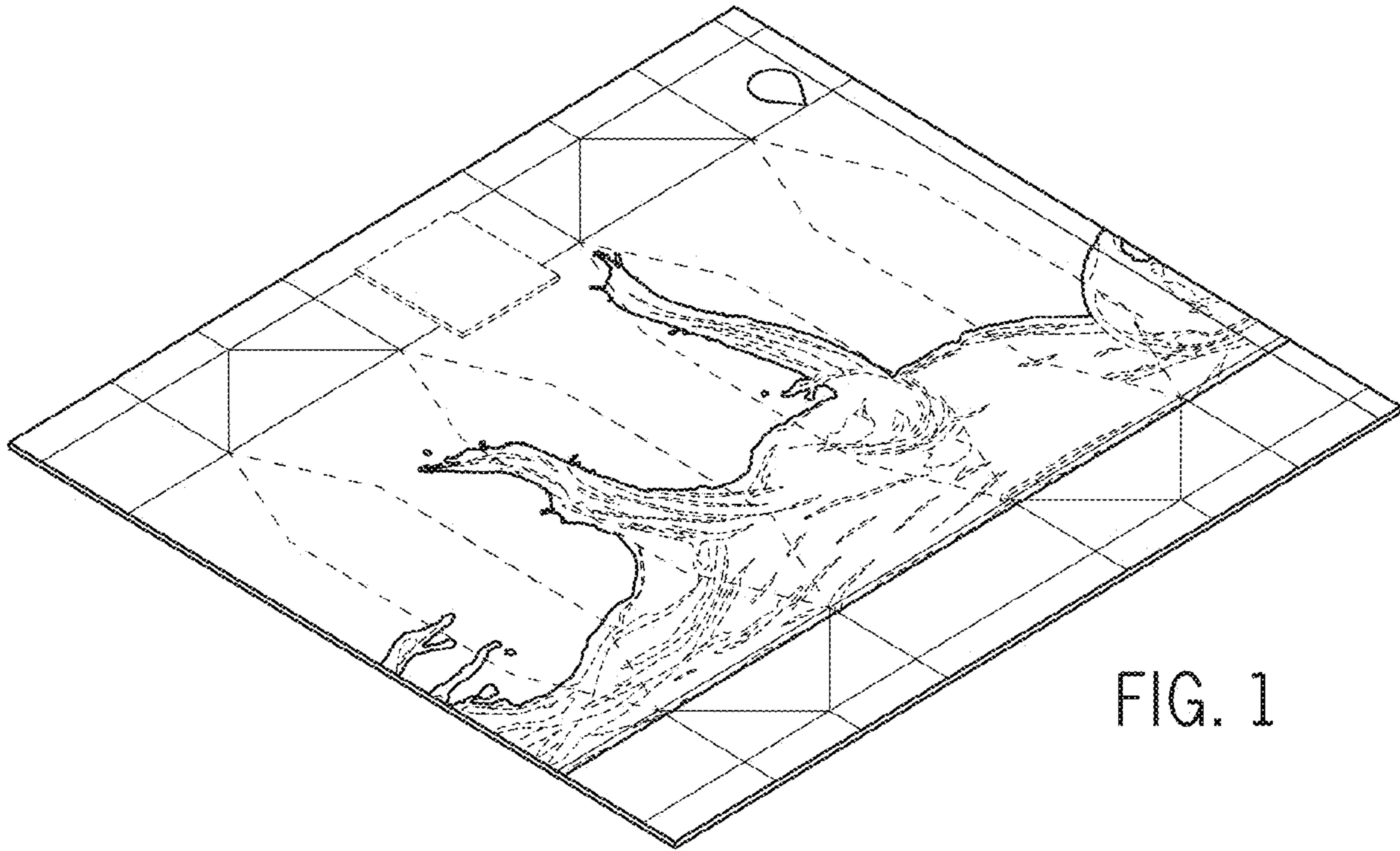

FIG. 1

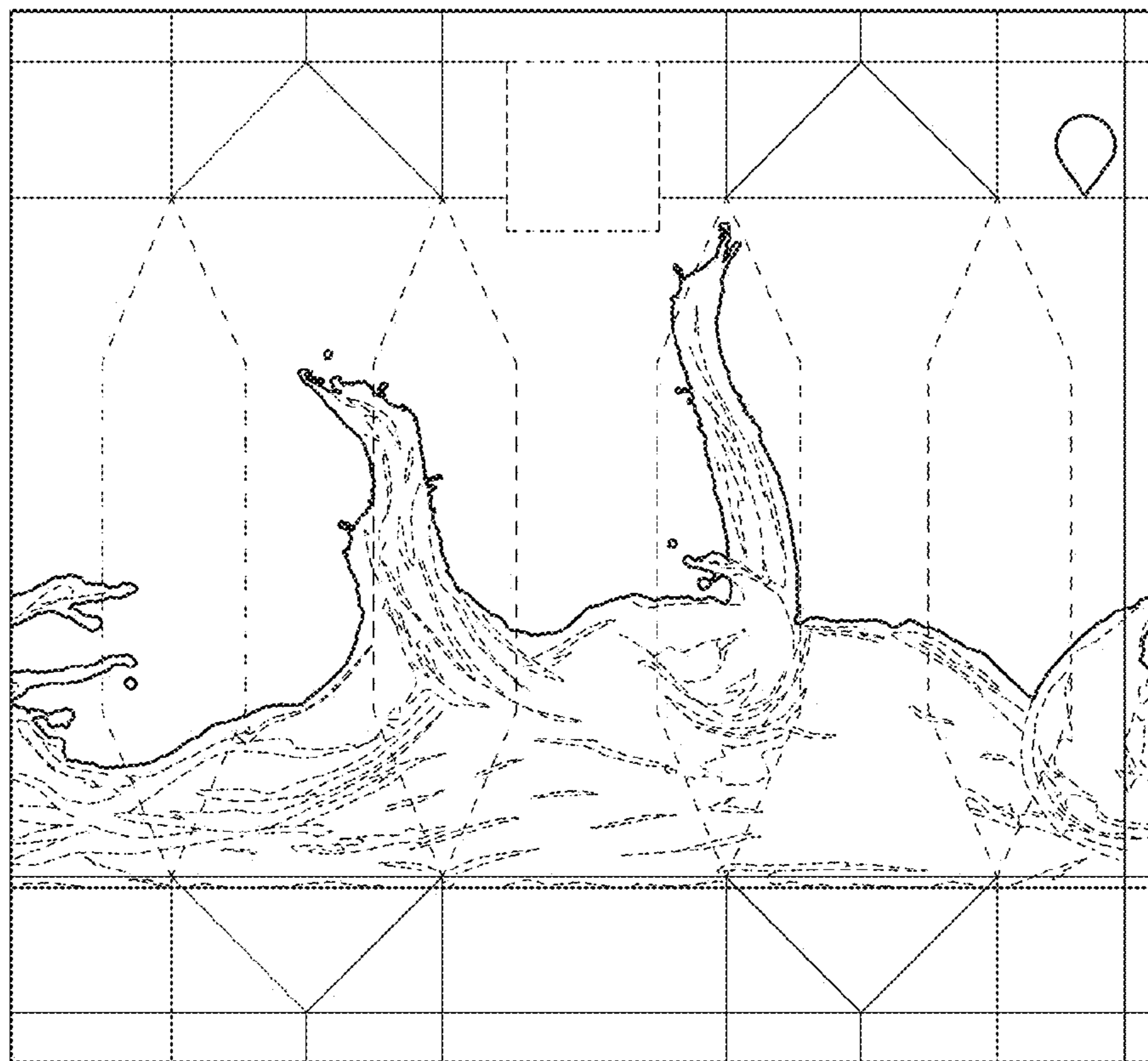

FIG. 2

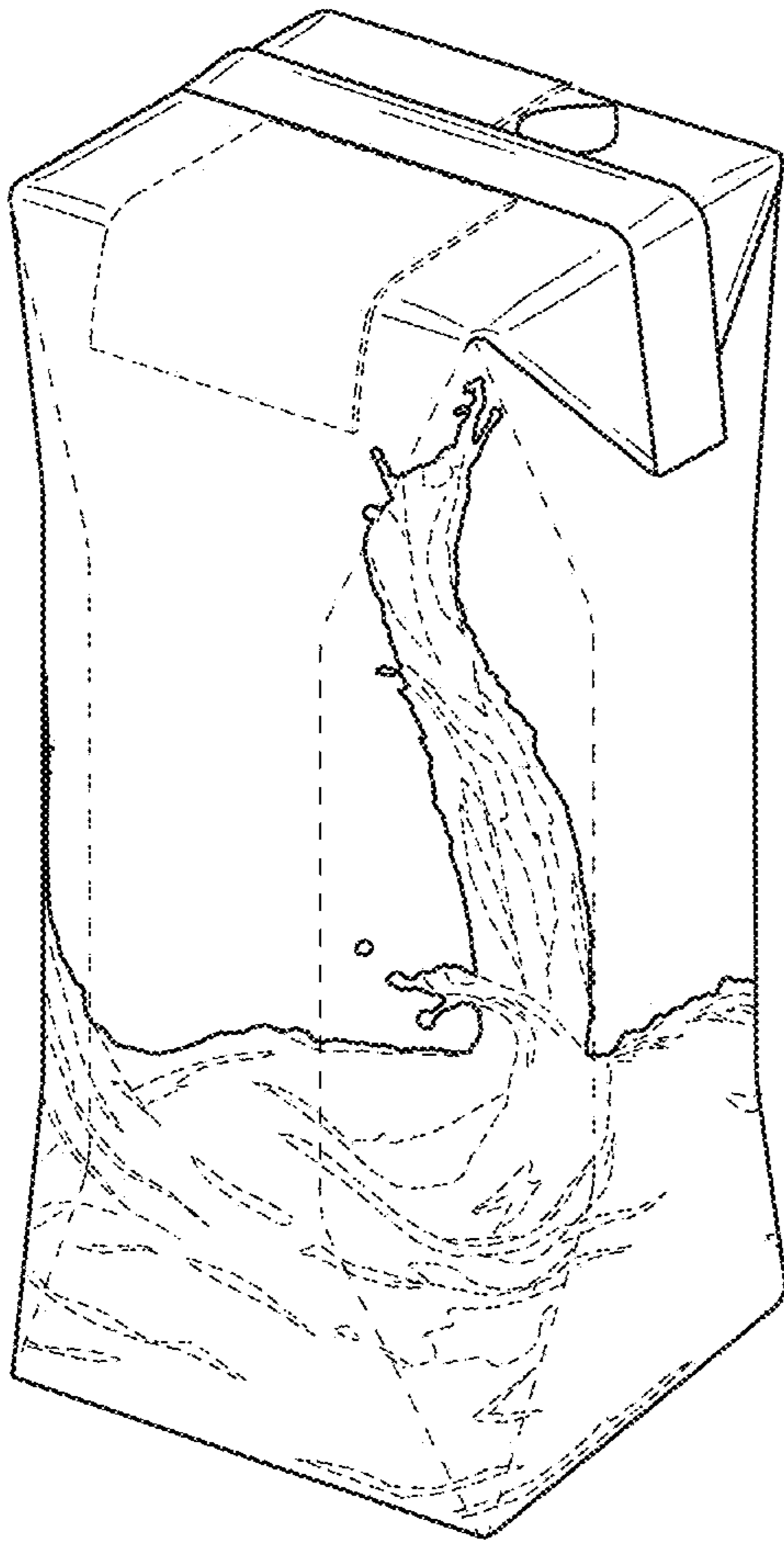

FIG. 3

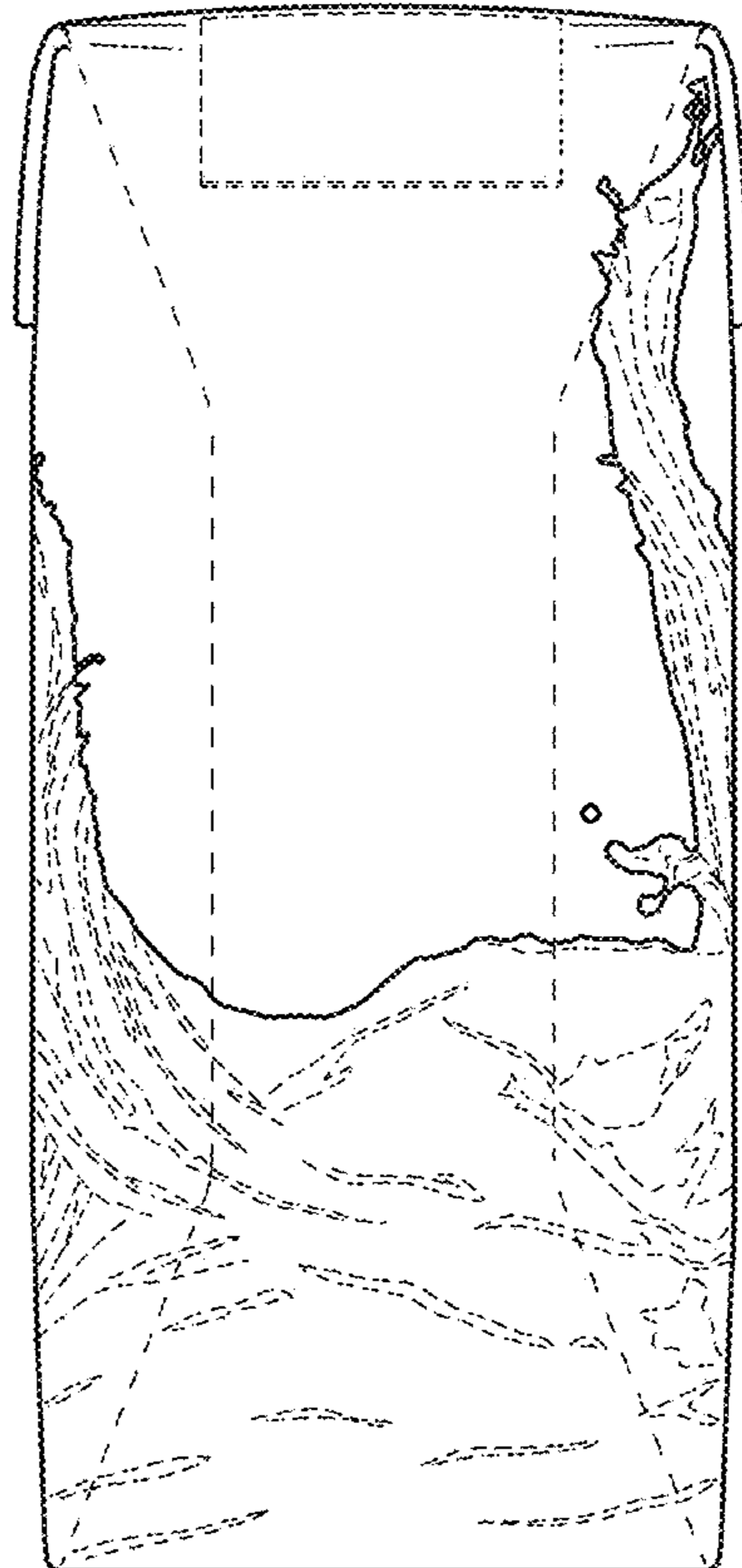

FIG. 4

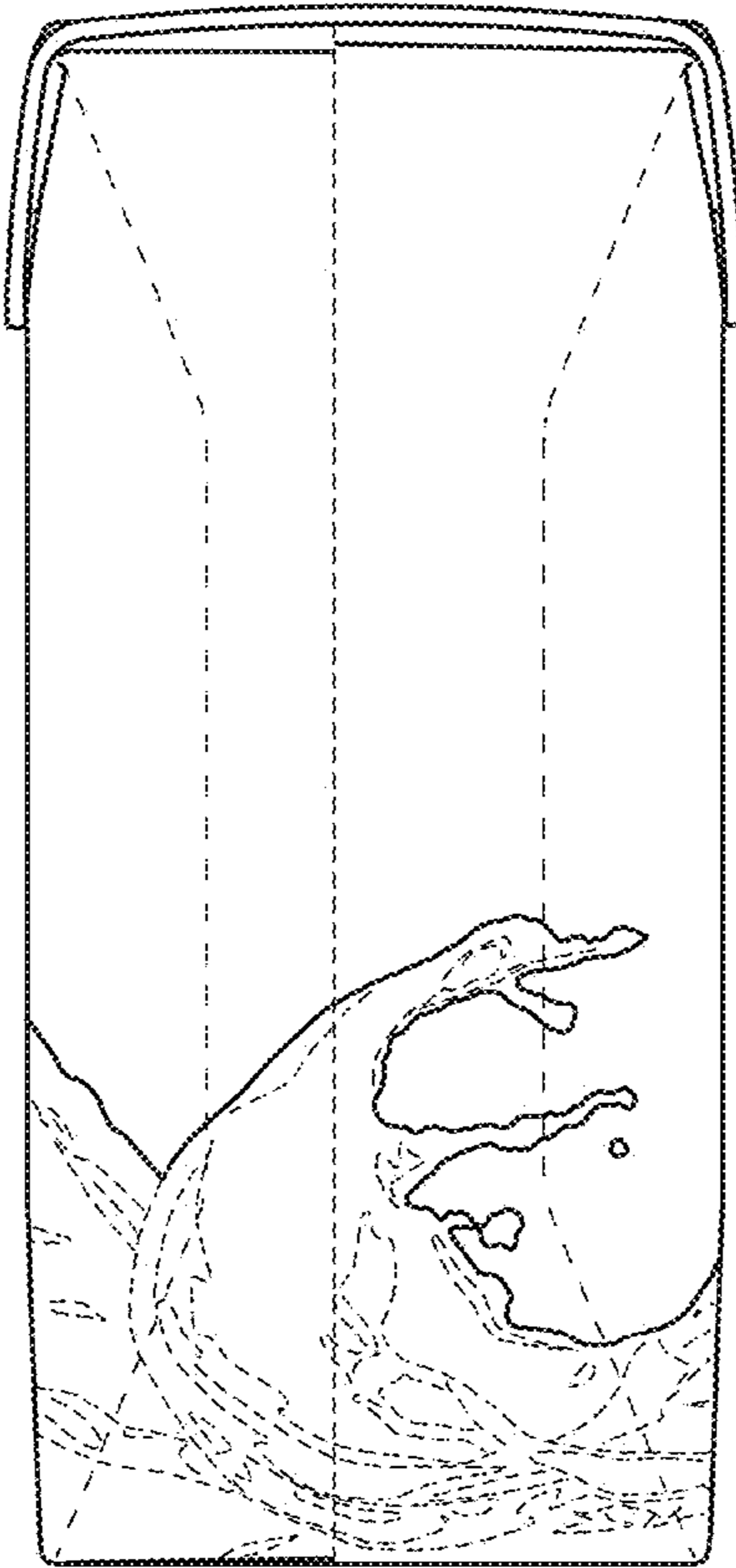

FIG. 5

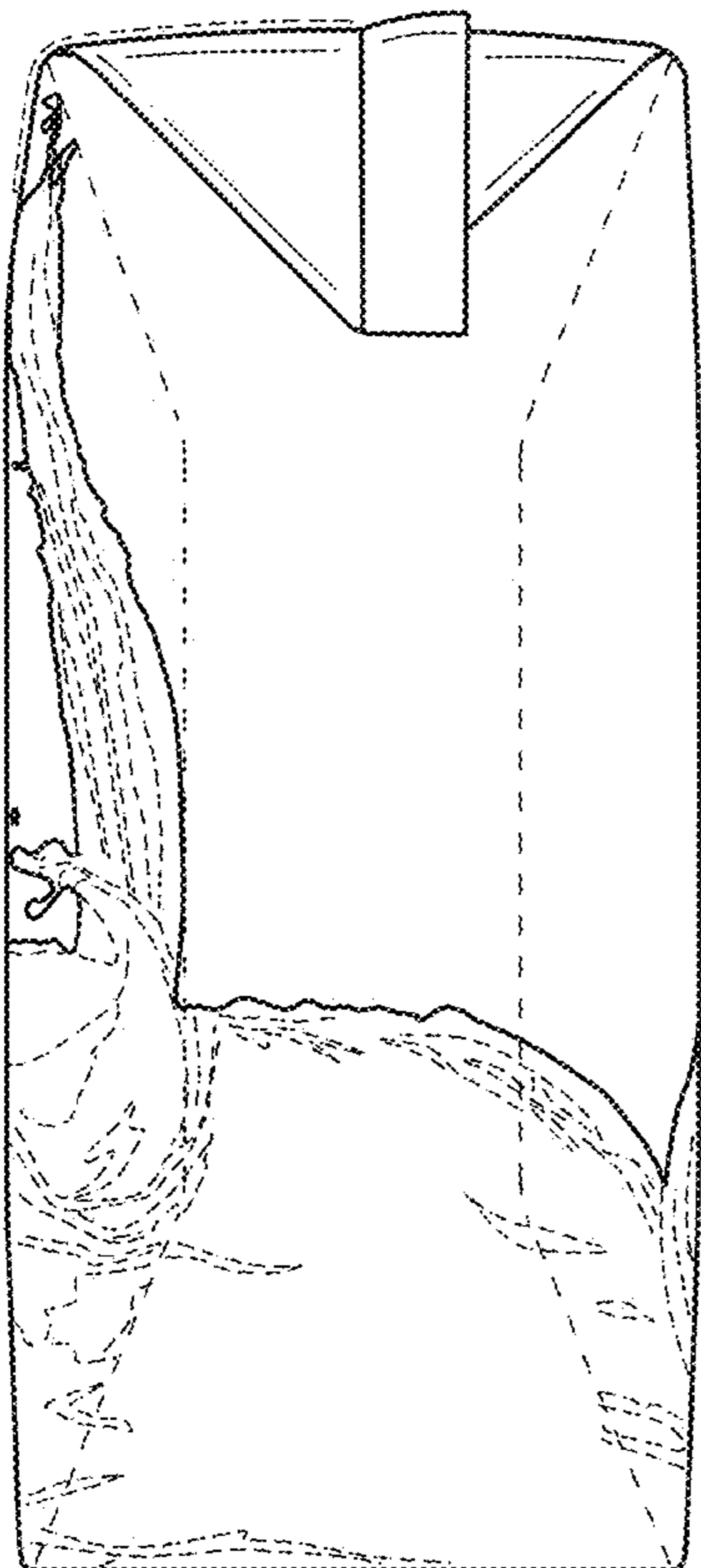

FIG. 6

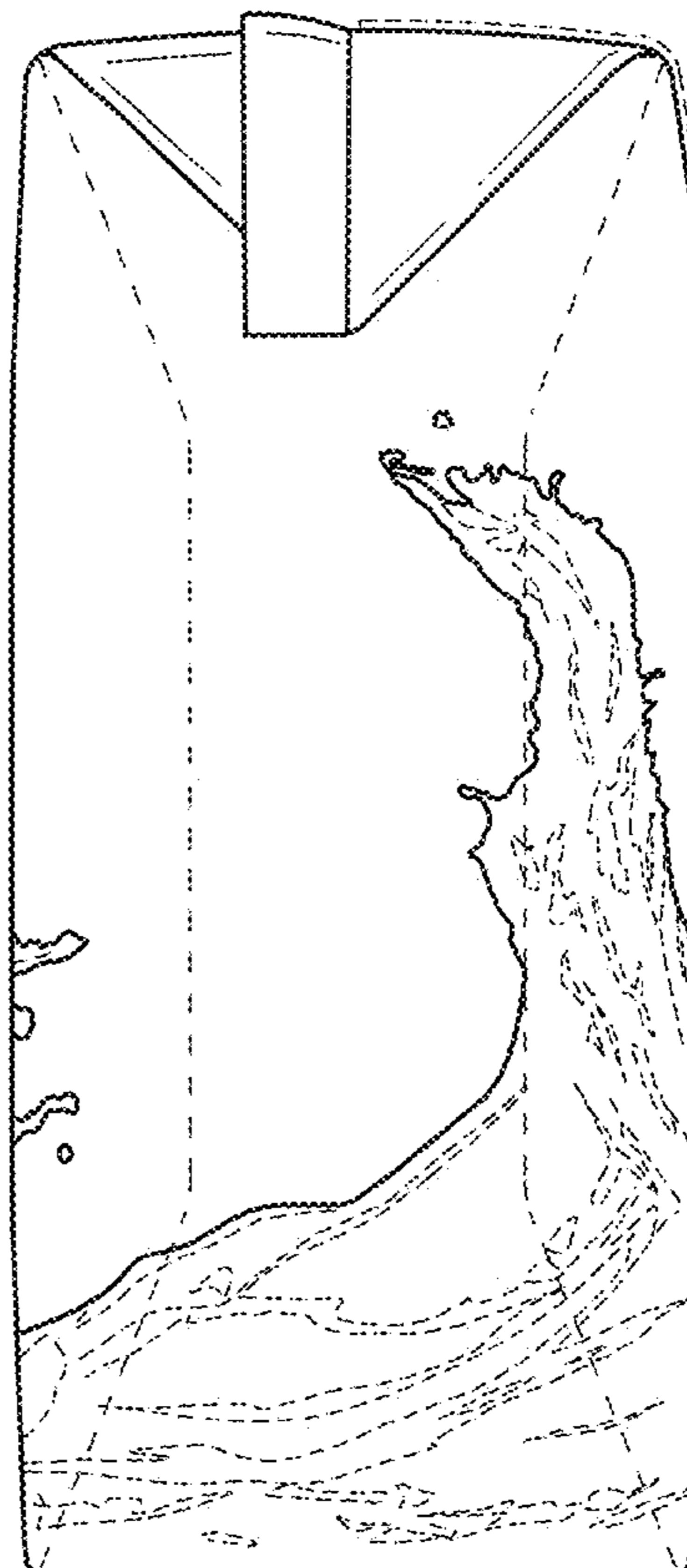

FIG. 7

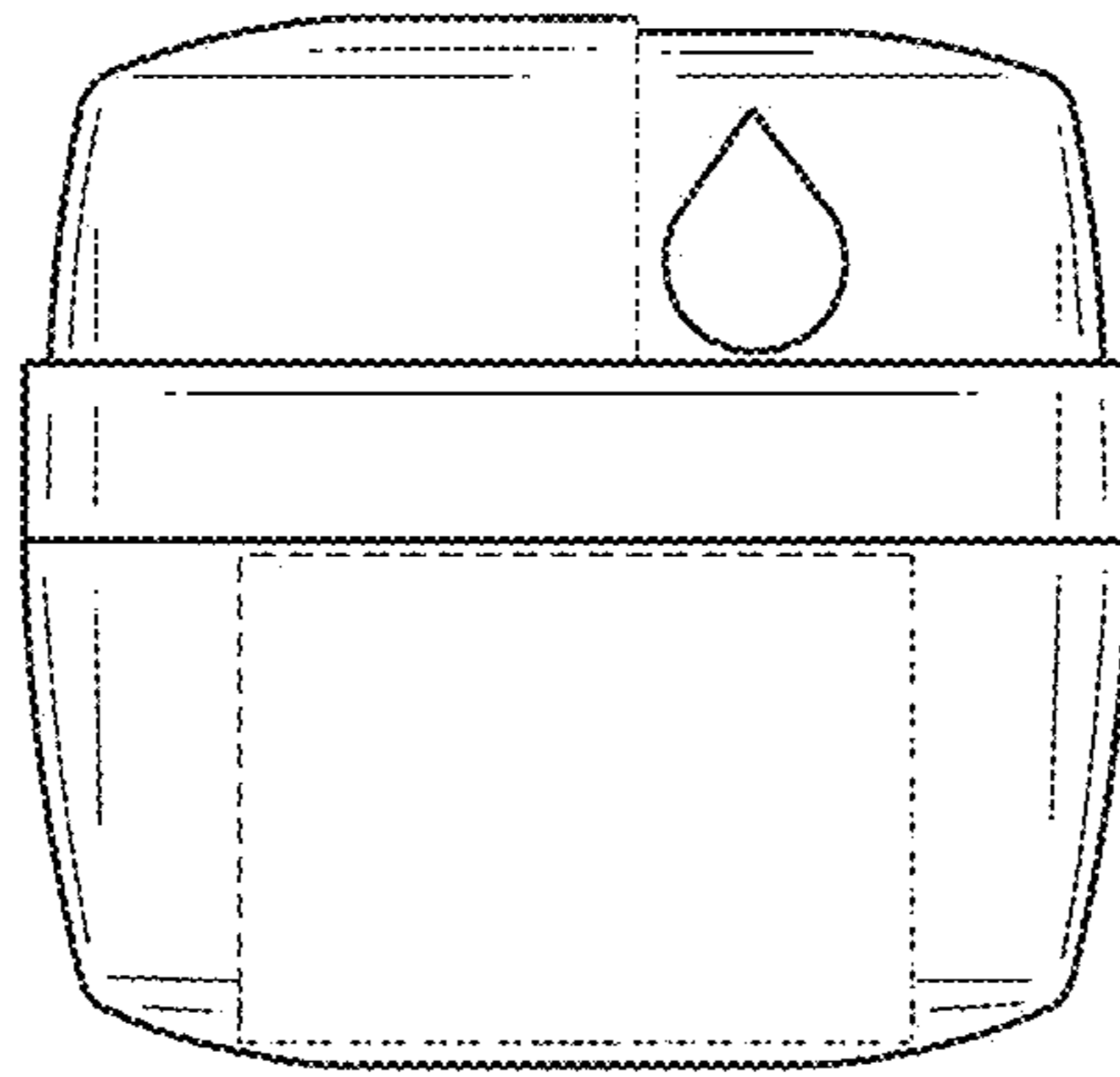

FIG. 8

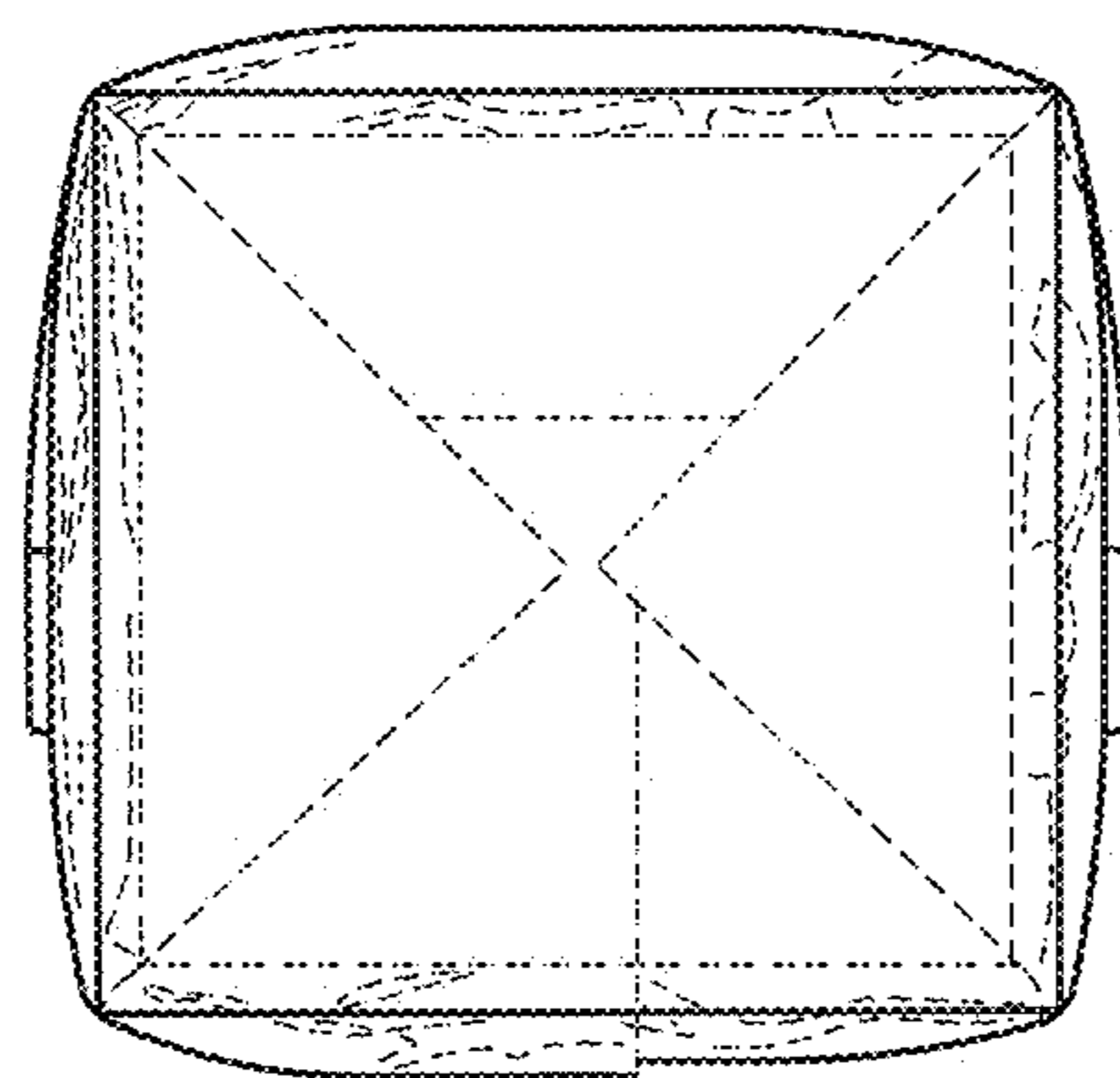

FIG. 9