



US00D885190S

(12) **United States Design Patent**
Chen et al.

(10) **Patent No.:** **US D885,190 S**
(45) **Date of Patent:** **** May 26, 2020**

(54) **CONTAINER**

(71) Applicant: **Conopco, Inc.**, Englewood Cliffs, NJ
(US)

(72) Inventors: **Weiqing Chen**, Shanghai (CN);
Thomas Peter Gilbert, Singapore (SG)

(73) Assignee: **Conopco, Inc.**, Englewood Cliffs, NJ
(US)

(**) Term: **15 Years**

(21) Appl. No.: **29/697,681**

(22) Filed: **Jul. 10, 2019**

Related U.S. Application Data

(62) Division of application No. 29/598,507, filed on Mar. 27, 2017, now Pat. No. Des. 855,466.

(30) **Foreign Application Priority Data**

Sep. 30, 2016 (EM) 003400373-0001
Sep. 30, 2016 (EM) 003400373-0002
Sep. 30, 2016 (EM) 003400373-0003

(51) **LOC (12) Cl.** **09-01**

(52) **U.S. Cl.**

USPC **D9/504**; D9/454

(58) **Field of Classification Search**

USPC D9/434-435, 444-445, 449, 454, 500,
D9/503-504, 516, 520, 529, 549, 558,
D9/715; D3/202, 203.2, 302; D7/608,
D7/629-630; D28/4, 8, 76, 91

CPC B65D 1/00; B65D 1/02; B65D 1/0223;
B65D 23/00; B65D 81/00; B65D
2501/00; B65D 2501/0009

See application file for complete search history.

(56) **References Cited**

U.S. PATENT DOCUMENTS

D20,336 S 11/1890 Whilldin
D24,991 S * 12/1895 Estes D9/504

D114,460 S 4/1939 Platt
D155,043 S 8/1949 Serra
D223,691 S 5/1972 Newman
D254,180 S 2/1980 Morin
4,440,181 A 4/1984 Scherer
4,703,863 A 11/1987 Kohus
D372,194 S 7/1996 Dallaire
D373,084 S 8/1996 Choi
D405,699 S 2/1999 Chae
D446,456 S 8/2001 Adachi et al.

(Continued)

OTHER PUBLICATIONS

Eye Cream; Herborist eye cream.

(Continued)

Primary Examiner — Dana Meyrow

(74) *Attorney, Agent, or Firm* — Gerard J. McGowan, Jr.

(57)

CLAIM

The ornamental design for a container, as shown and described.

DESCRIPTION

The patent or application file contains at least one drawing executed in color. Copies of this patent or patent application publication with color drawing(s) will be provided by the Office upon request and payment of the necessary fee.

FIG. 1 is a perspective view of a container showing our new design;

FIG. 2 is a front elevational view thereof,

FIG. 3 is a rear elevational view thereof,

FIG. 4 is a side elevational view thereof;

FIG. 5 is an opposing side elevational view thereof; and,

FIG. 6 is a top plan view thereof.

1 Claim, 4 Drawing Sheets
(4 of 4 Drawing Sheet(s) Filed in Color)

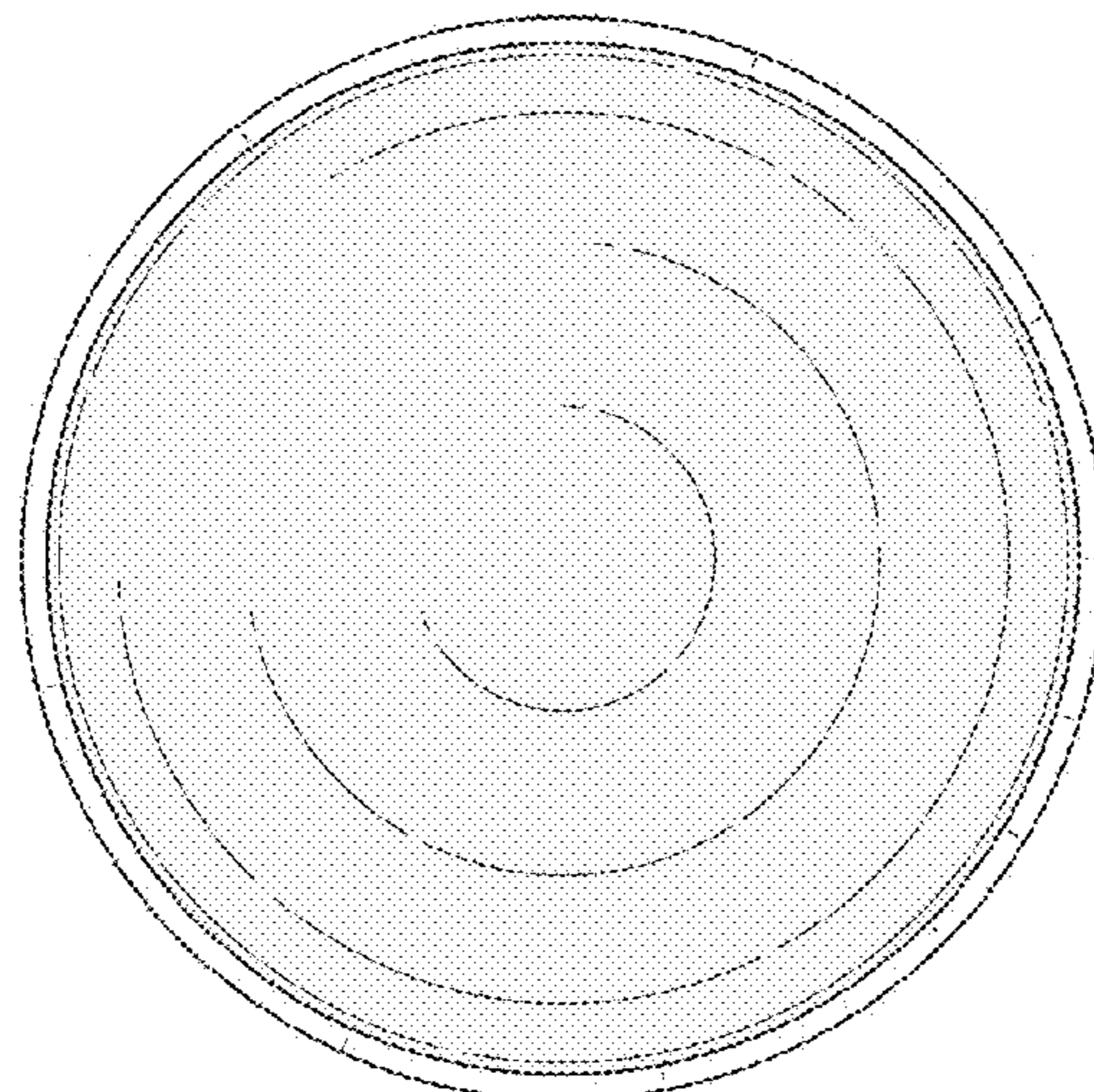
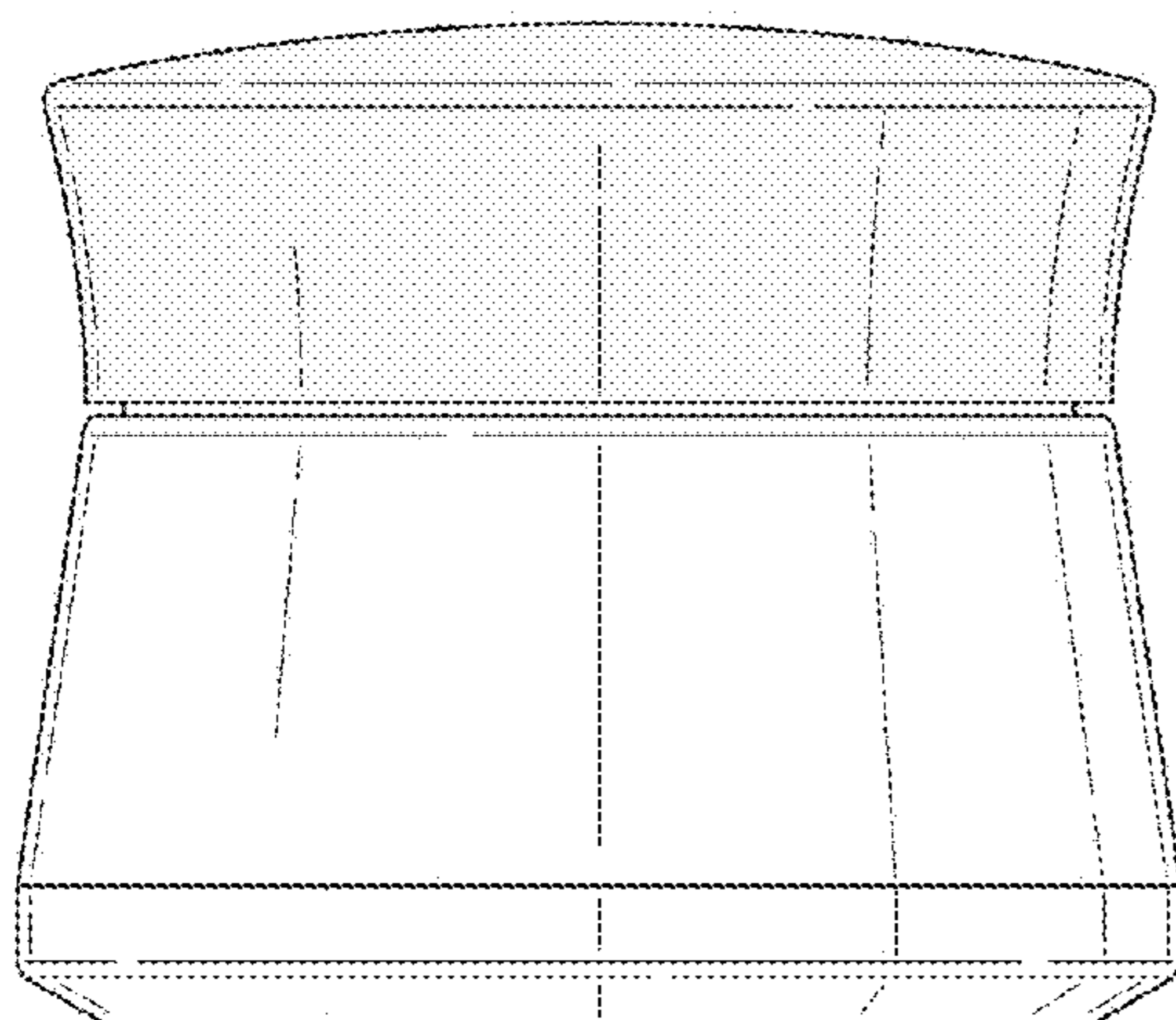

(56)

References Cited

U.S. PATENT DOCUMENTS

D474,341 S 5/2003 Cantone et al.
 D505,074 S 5/2005 Bakic
 D509,434 S 9/2005 Haruta
 D512,914 S 12/2005 Moretti
 D524,161 S * 7/2006 Sauer D28/82
 D530,572 S 10/2006 Daams
 D531,041 S * 10/2006 Sauer D9/529
 D536,614 S 2/2007 Peterson et al.
 D539,480 S * 3/2007 Kostow D28/76
 D574,710 S 8/2008 Gangrade
 D619,456 S 7/2010 Walters
 D662,422 S * 6/2012 Avakian D9/435
 D695,116 S * 12/2013 Ahn D9/454
 D699,593 S 2/2014 Boon et al.
 D702,755 S * 4/2014 Bould D16/237
 D716,427 S 10/2014 Lim et al.

D739,738 S 9/2015 Kawai
 D751,135 S * 3/2016 Bould D16/237
 D816,505 S 5/2018 Percassi
 D850,917 S * 6/2019 Kuma D9/504
 D850,919 S * 6/2019 Kuma D9/504
 D855,466 S * 8/2019 Chen D9/504
 2011/0297704 A1 12/2011 Esteve et al.

OTHER PUBLICATIONS

Silky All-Day Moisturizing Facial Cream; Herborist Silky All-Day Moisturizing Facial Cream.
 Silky All Day Moisturizing Eye Gel; Heborist.
 Day cream; Herborist day cream.
 Regener-activ Contorno de Ojos; Ponds; Eye cream pack from Spain.
 Day Cream & Eye Cream Range; Herborist.

* cited by examiner

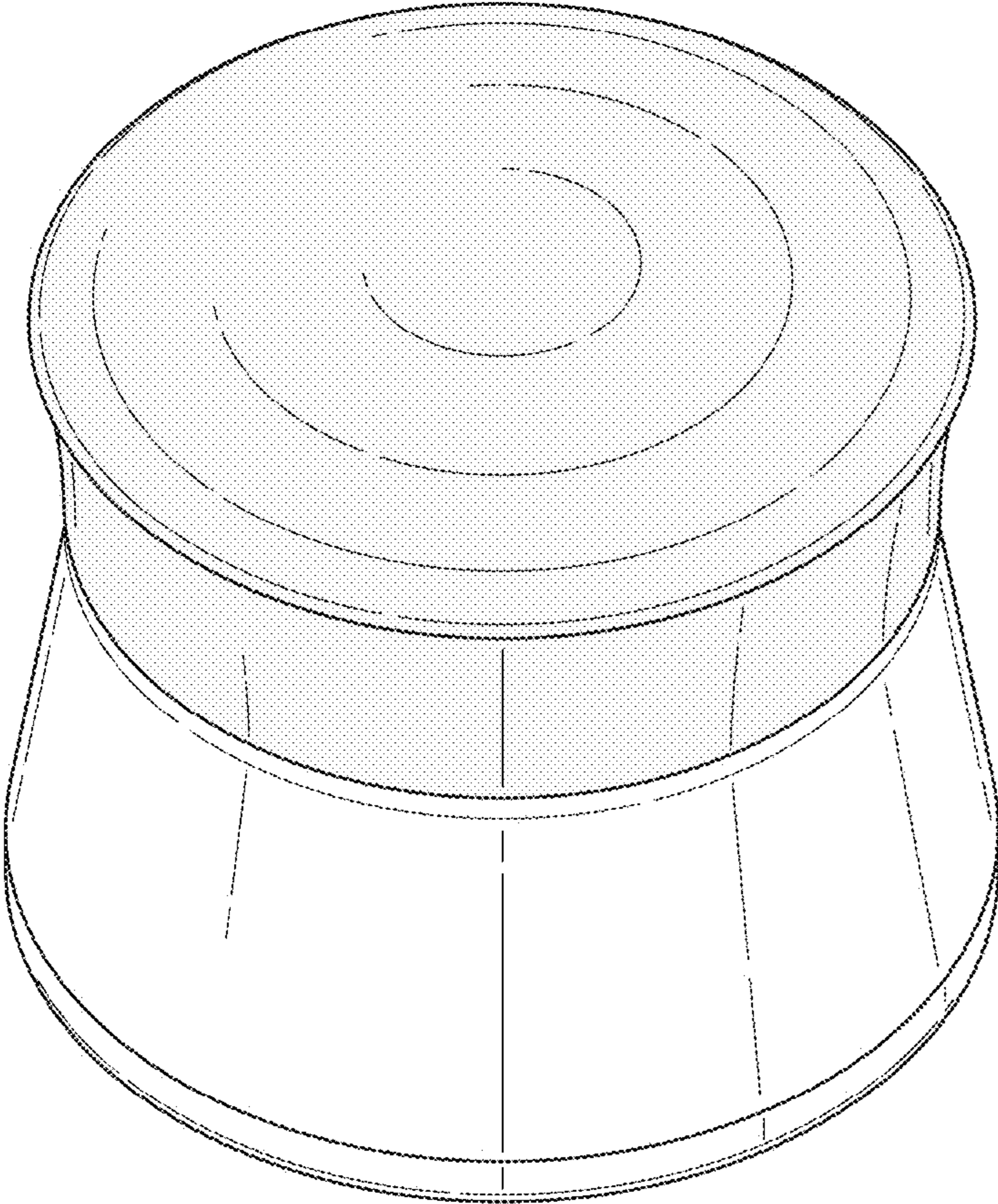

Fig. 1

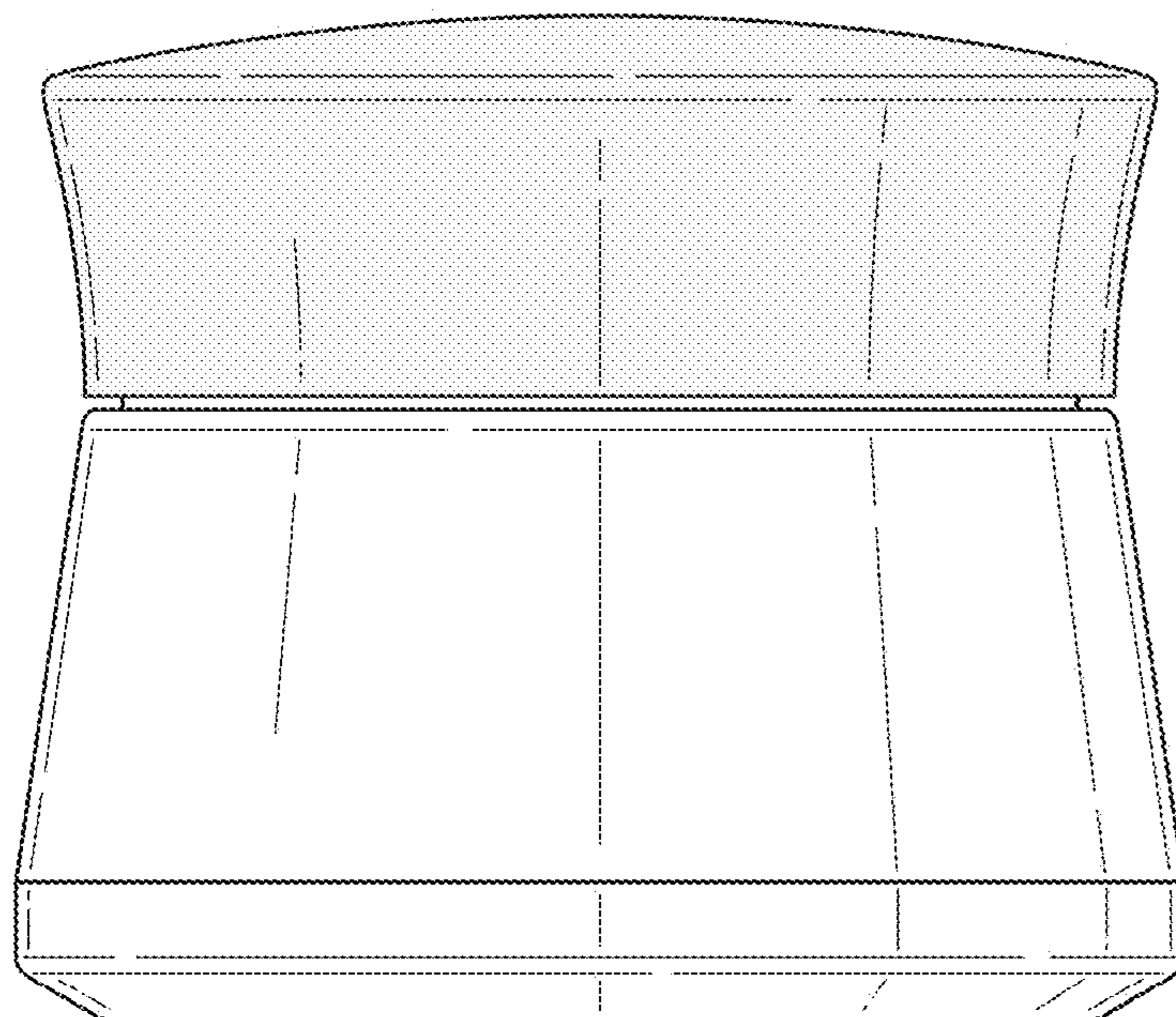

Fig. 2

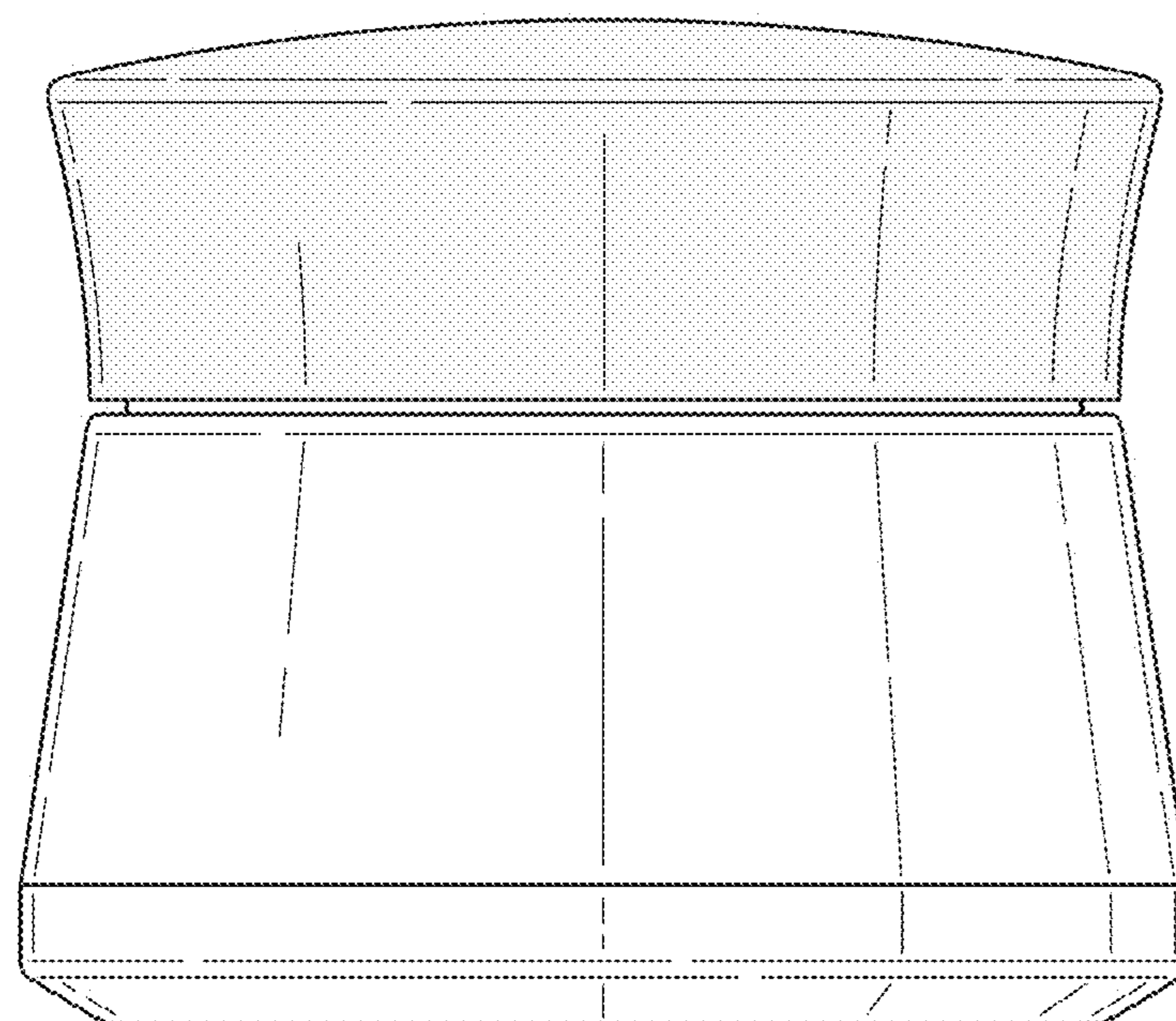

Fig. 3

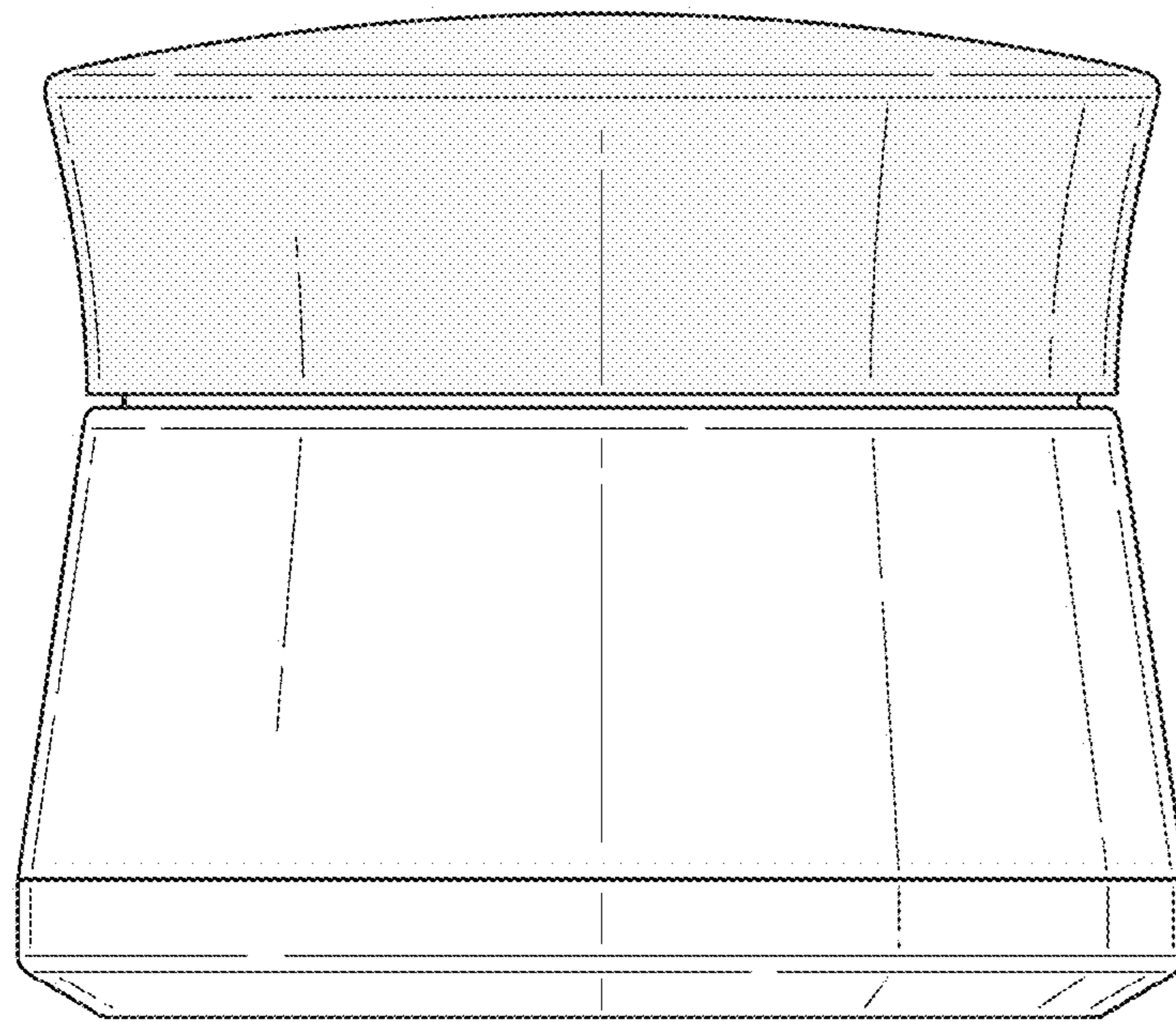

Fig. 4

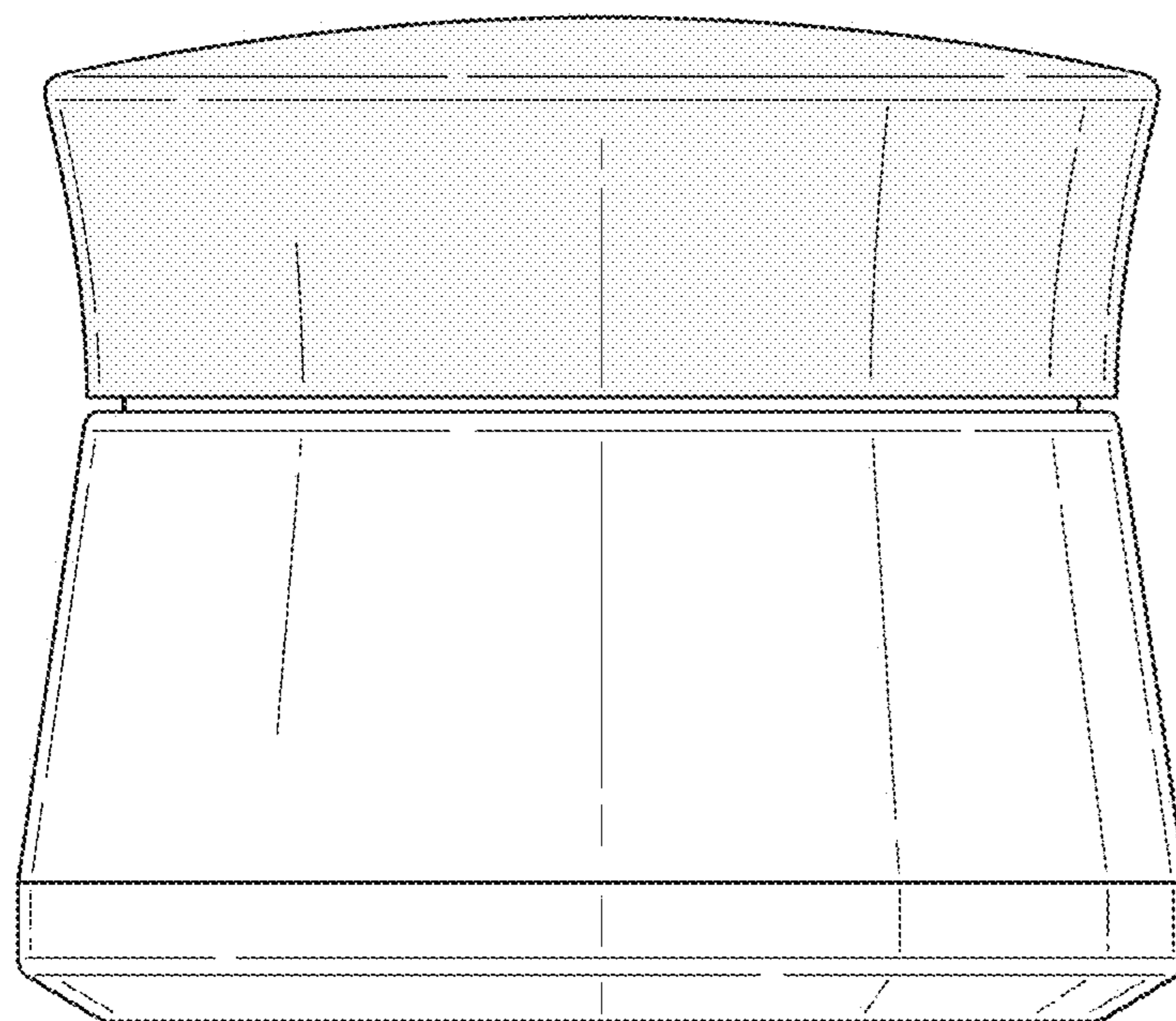

Fig. 5

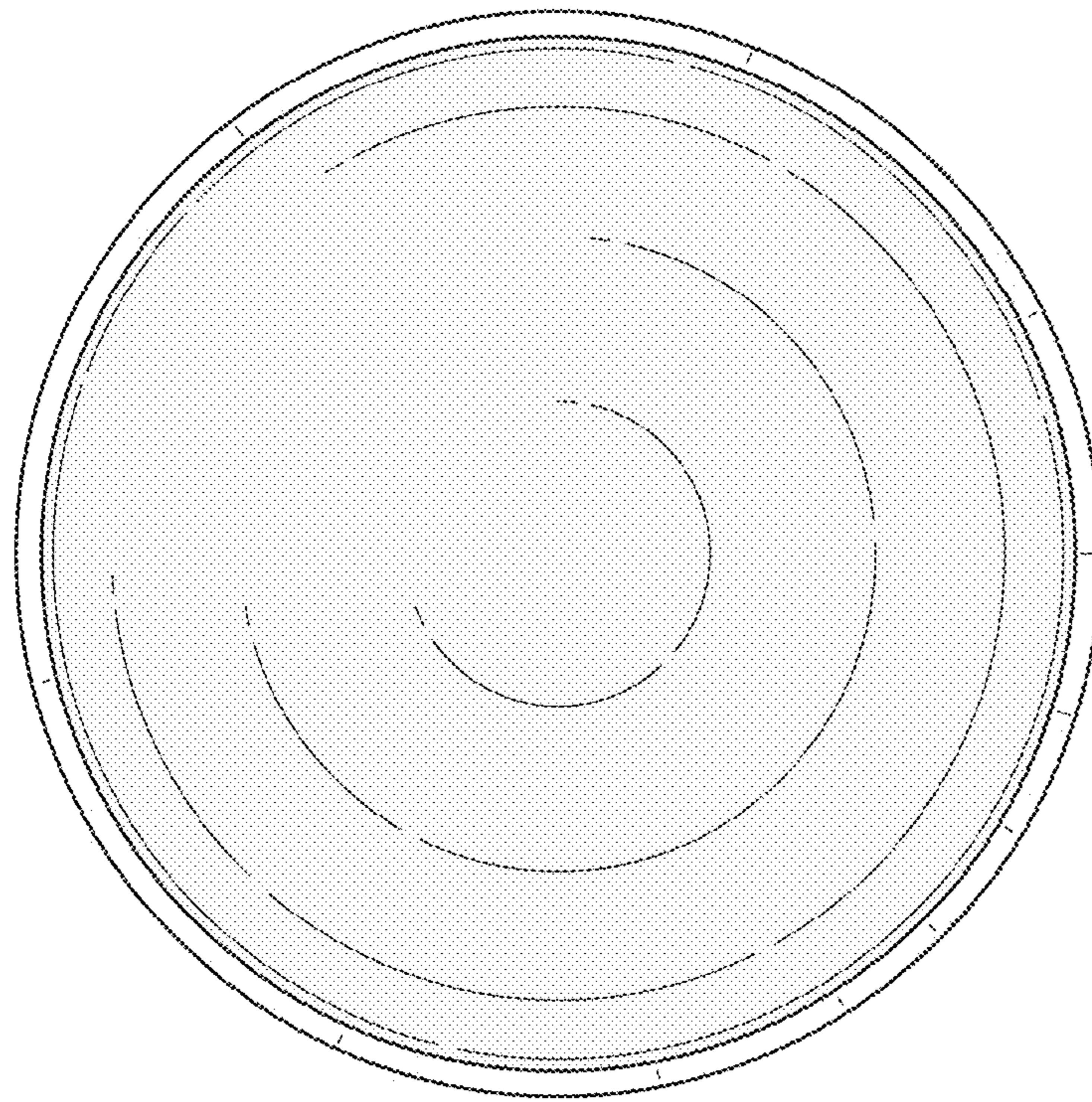

Fig. 6