



US00D885127S

(12) **United States Design Patent**  
**Lin**

(10) **Patent No.:** **US D885,127 S**

(45) **Date of Patent:** **\*\* May 26, 2020**

(54) **KNIFE HANDLE**

(71) Applicant: **Zhejiang Qingyou E-business Co., Ltd.**, Hangzhou (CN)

(72) Inventor: **Zhijie Lin**, Wenzhou (CN)

(73) Assignee: **ZHEJIANG QINGYOU E-BUSINESS CO., LTD.**, Hangzhou (CN)

(\*\*) Term: **15 Years**

(21) Appl. No.: **29/678,396**

(22) Filed: **Jan. 29, 2019**

(51) **LOC (12) Cl.** ..... **07-03**

(52) **U.S. Cl.**  
USPC ..... **D7/401.2; D7/649**

(58) **Field of Classification Search**  
USPC ..... D7/393-395, 401.2, 642-652, 693,  
D7/695-696; D8/93, 97-100, 107, 300,  
D8/321; D22/117-118

CPC ..... A01B 1/20; A01B 1/22; A22C 25/006;  
A47G 21/06; A47G 21/065; A61B  
17/3211; A61B 17/3213; B21D 53/64;  
B25G 3/36; B26B 1/00; B26B 1/08;  
B26B 1/10; B26B 3/00; B26B 3/02;  
B26B 3/03; B26B 3/04; B26B 3/06;  
B26B 5/00; B26B 5/001; B26B 5/007;  
B26B 7/00; B26B 7/005; B26B 9/00;  
B26B 9/02; B26B 11/00; B26B 11/006;  
B26B 17/00; B26B 17/006; B26B 29/02

See application file for complete search history.

(56) **References Cited**

**U.S. PATENT DOCUMENTS**

5,692,308 A \* 12/1997 Di Libero ..... B26B 9/02  
30/308  
D548,543 S \* 8/2007 Izaki ..... D7/649

D559,044 S \* 1/2008 Ono ..... D7/649  
D572,542 S \* 7/2008 Epstein ..... D7/649  
D595,544 S \* 7/2009 Thun ..... D7/649  
D599,172 S \* 9/2009 Wang ..... D7/642  
D637,048 S \* 5/2011 Ono ..... D7/649  
D649,412 S \* 11/2011 Lo ..... D7/649  
D675,068 S \* 1/2013 Mahaffey ..... D7/642  
D816,433 S \* 5/2018 Murken ..... D7/649  
D833,219 S \* 11/2018 Liu ..... D7/401.2  
D842,663 S \* 3/2019 Heine ..... D7/649  
D849,476 S \* 5/2019 Heine ..... D7/401.2

\* cited by examiner

*Primary Examiner* — Ricky Pham

(57) **CLAIM**

The ornamental design for a knife handle, as shown and described.

**DESCRIPTION**

FIG. 1 is a perspective view of a knife handle showing my new design;  
FIG. 2 is a front elevational view thereof;  
FIG. 3 is a rear elevational view thereof;  
FIG. 4 is an enlarged left side elevational view thereof;  
FIG. 5 is an enlarged right side elevational view thereof;  
FIG. 6 is a top plan view thereof;  
FIG. 7 is a bottom plan view thereof; and,  
FIG. 8 is an enlarged view of portion 8 shown in FIG. 1.  
The broken lines in the drawings illustrate portions of the knife handle that form no part of the claimed design.

**1 Claim, 8 Drawing Sheets**

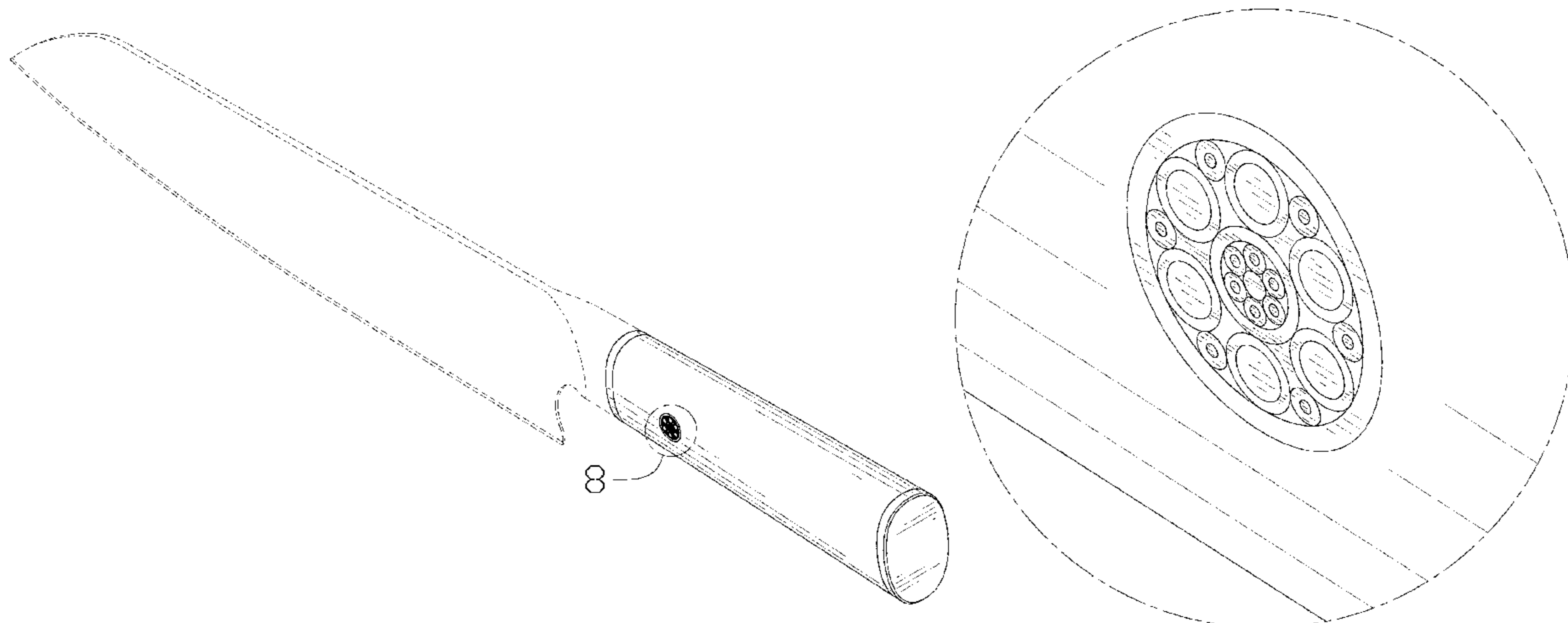

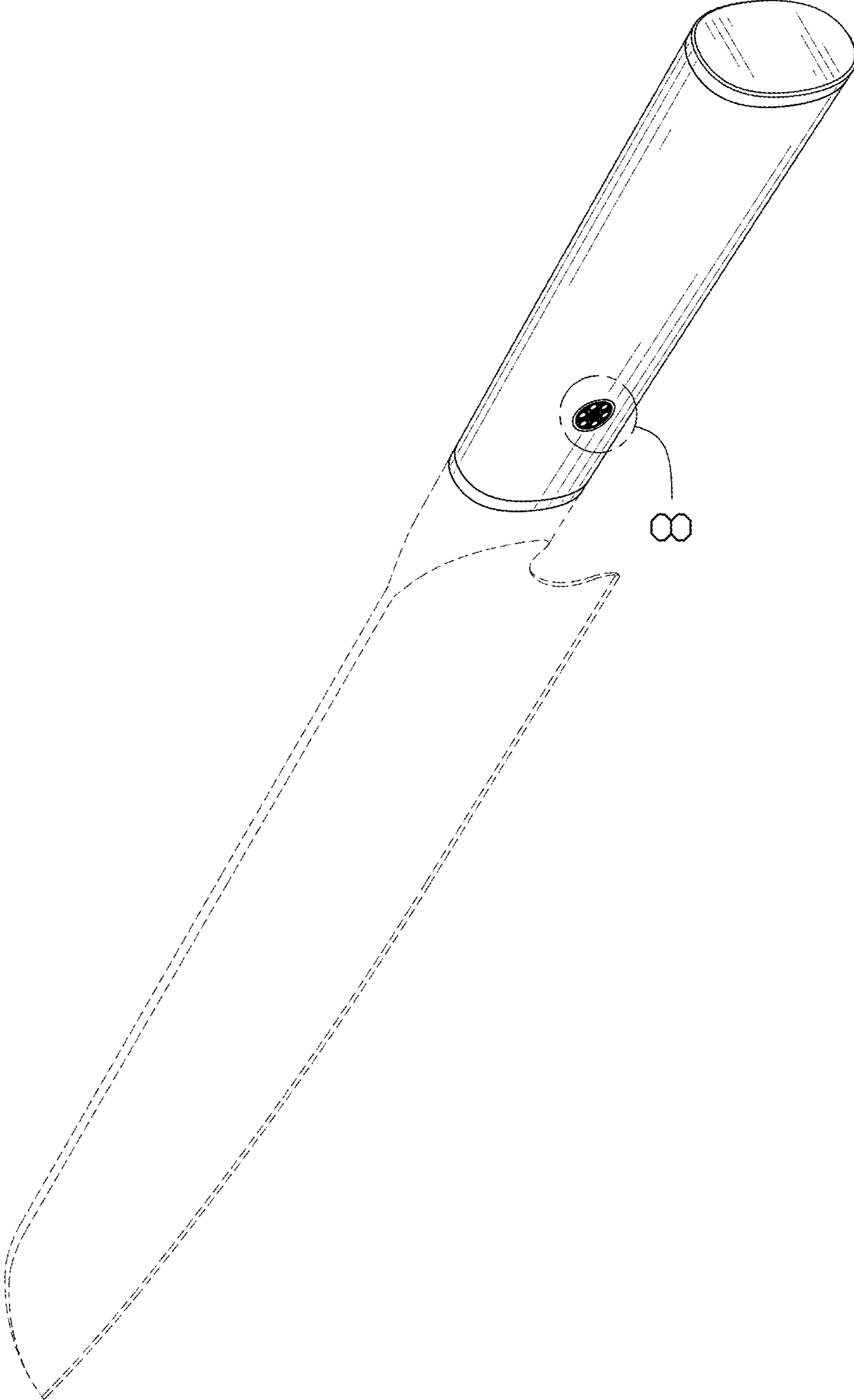

FIG. 1

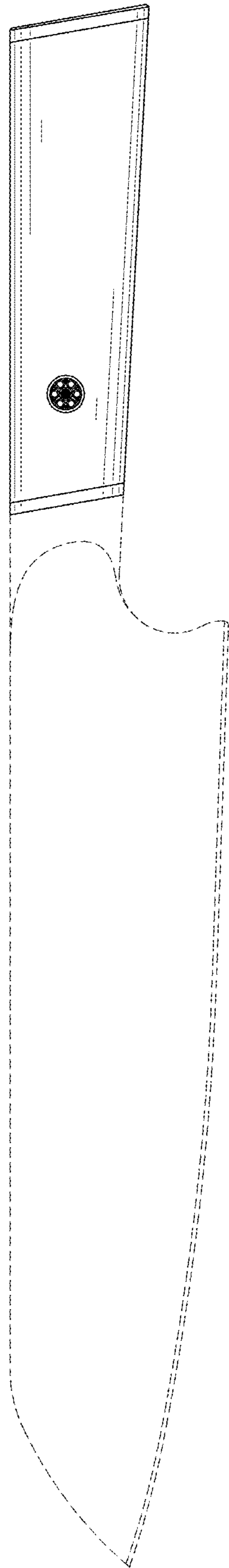

FIG. 2

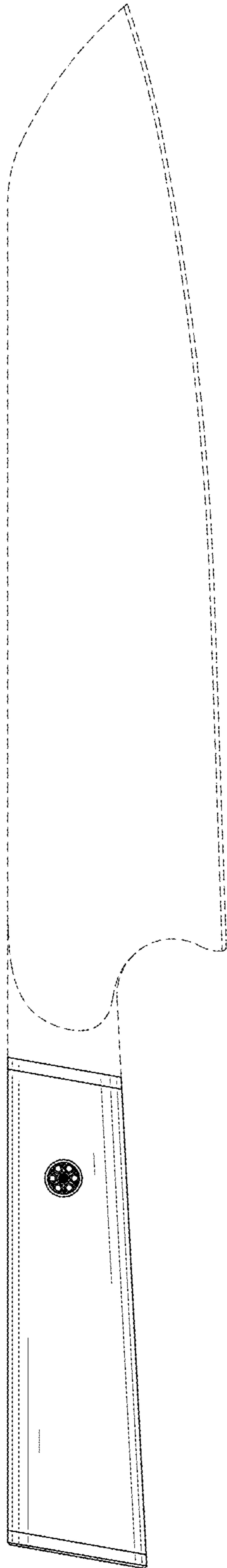

FIG. 3

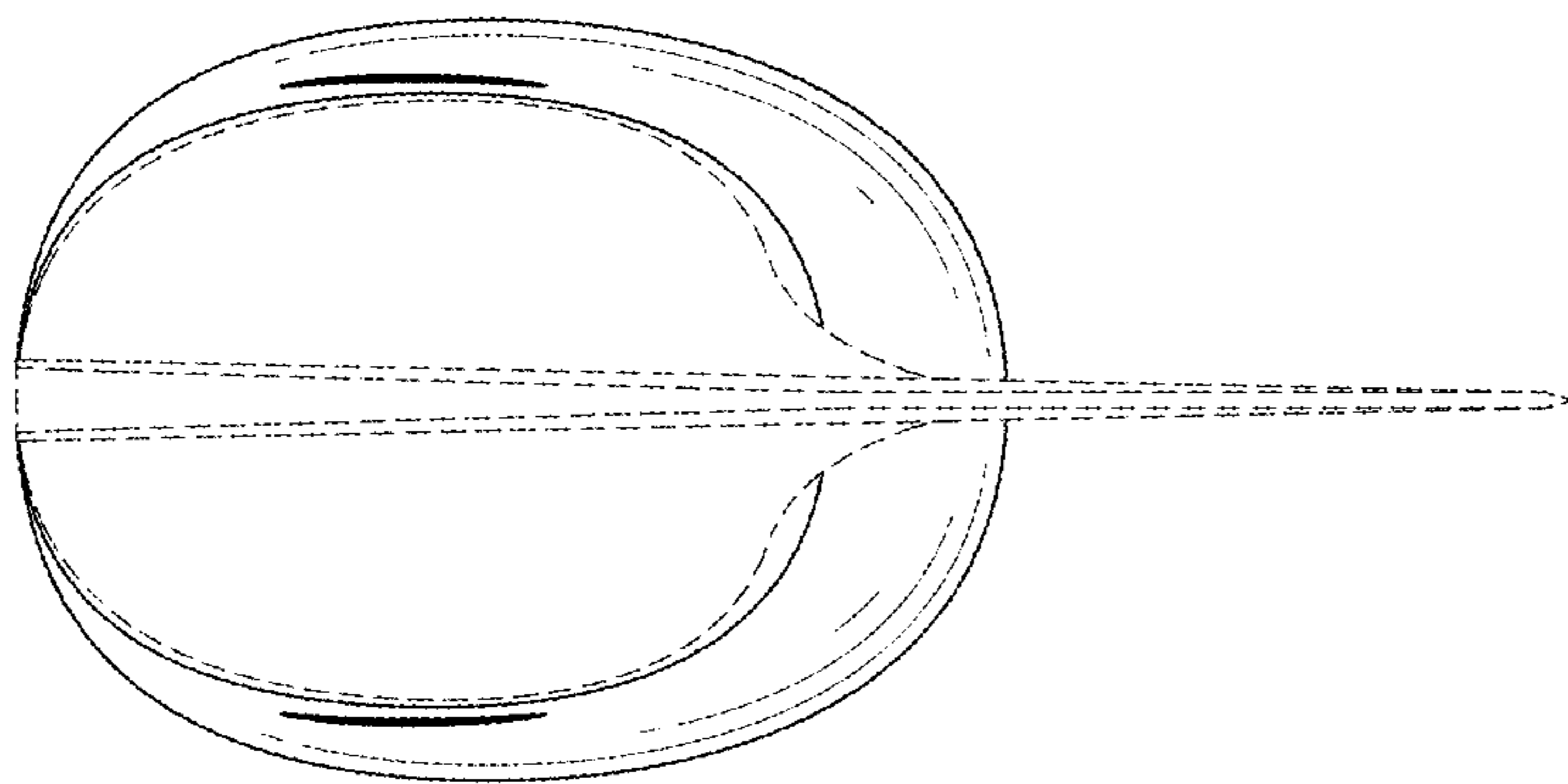

FIG. 4

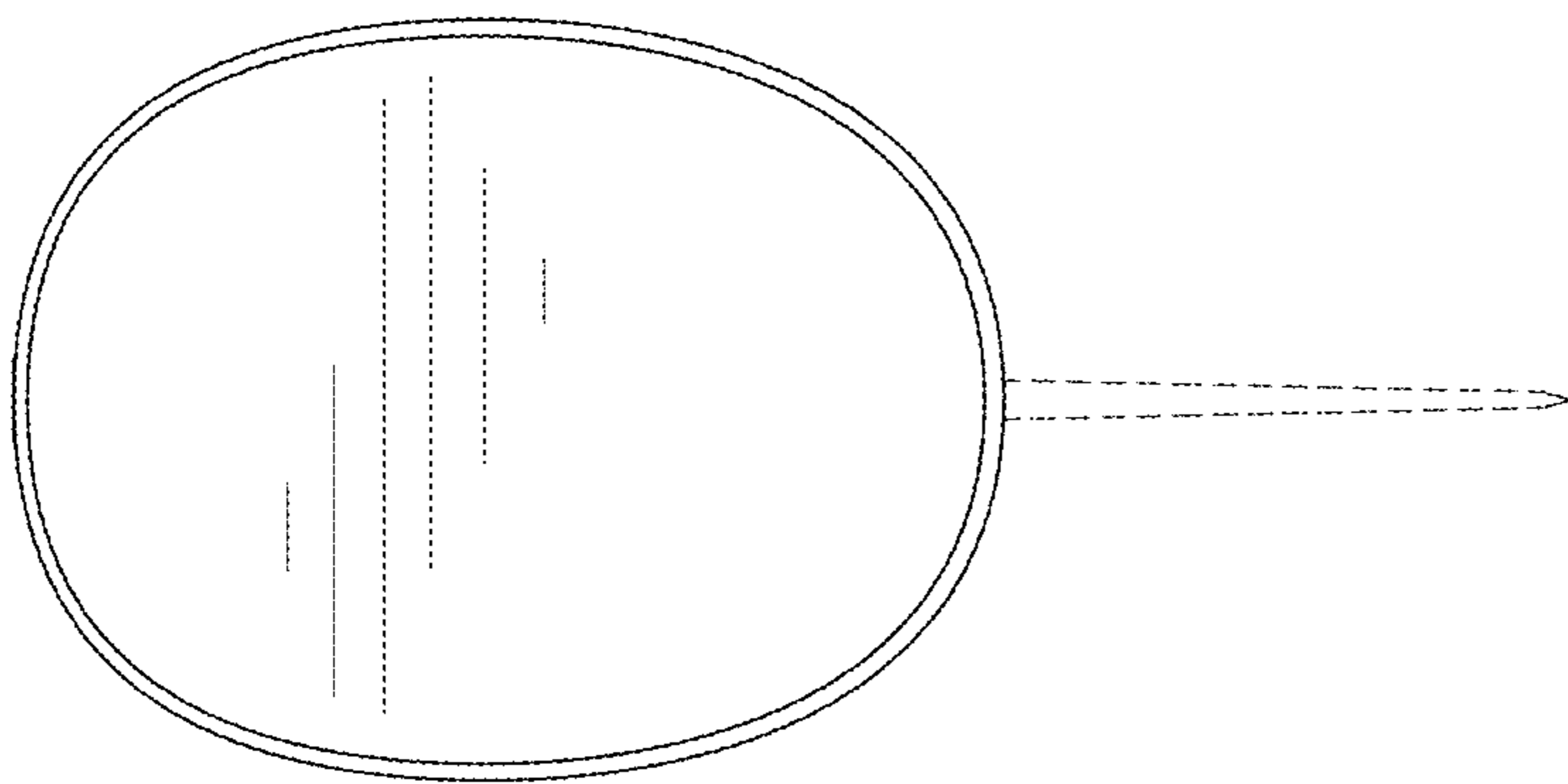

FIG. 5

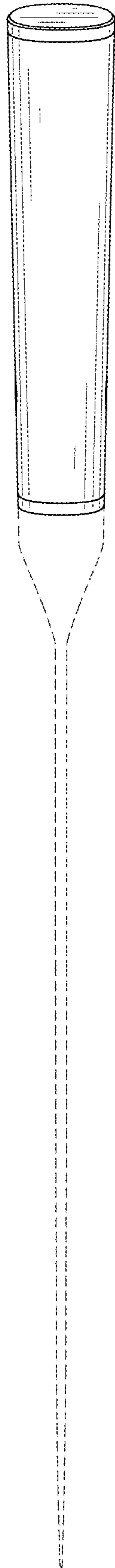

FIG. 6

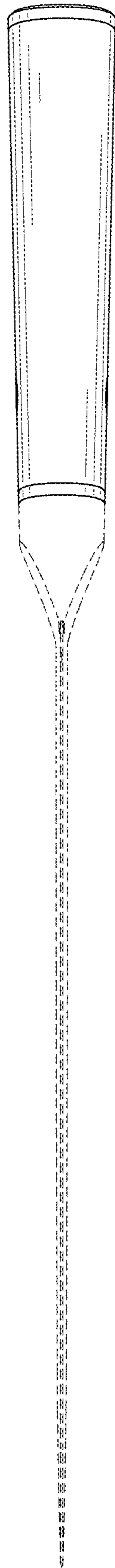

FIG. 7



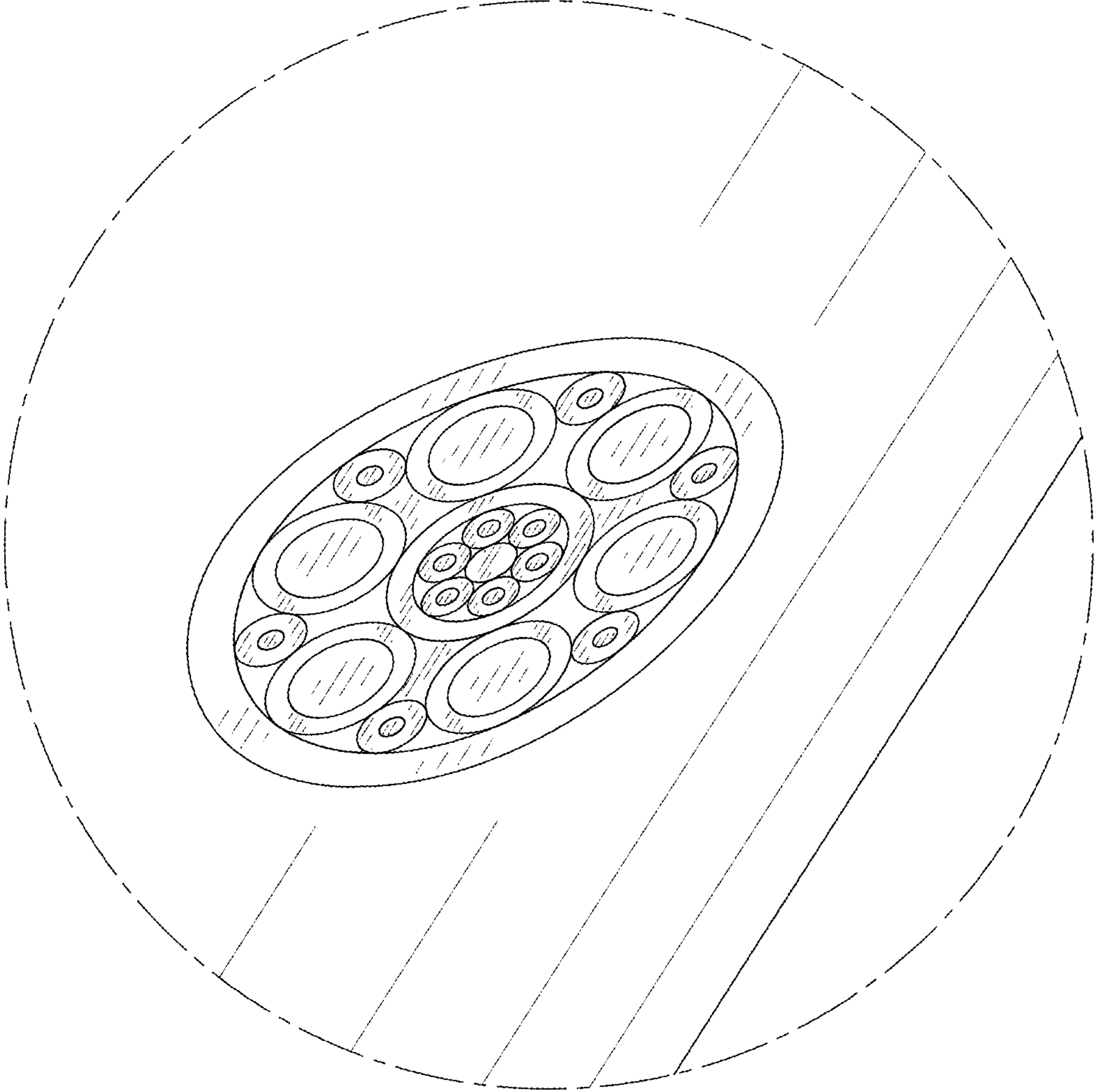

FIG. 8