



US00D885121S

(12) **United States Design Patent**
Born et al.

(10) **Patent No.:** **US D885,121 S**

(45) **Date of Patent:** **** May 26, 2020**

(54) **CUP LID**

(71) Applicants: **Lily Ann Born**, Skokie, IL (US);
Joseph Born, Lincolnwood, IL (US)

(72) Inventors: **Lily Ann Born**, Skokie, IL (US);
Joseph Born, Lincolnwood, IL (US)

(**) Term: **15 Years**

(21) Appl. No.: **29/688,243**

(22) Filed: **Apr. 19, 2019**

(51) **LOC (12) Cl.** **07-99**

(52) **U.S. Cl.**
USPC **D7/392; D7/392.1**

(58) **Field of Classification Search**
USPC D7/387, 391, 394, 396.2, 509-511, 538,
D7/900; D3/201, 202; D9/434, 435,
D9/436, 439, 440, 442, 443, 446-450,
D9/499, 686

CPC .. A61J 1/00; A61J 1/1412; B65D 1/00; B65D
1/02; B65D 1/10; B65D 1/46; B65D
2585/56; B65D 2585/545; B65D 41/00;
B65D 41/38; B65D 41/56; B65D 41/62;
B65D 47/00; B65D 47/06; B65D 47/08;
B65D 2543/00046; B65D 2543/00092;
B65D 2543/00296; B65D 5/46; B65D
2251/00

See application file for complete search history.

(56) **References Cited**

U.S. PATENT DOCUMENTS

D442,029	S	*	5/2001	Otake	D7/510
D478,779	S	*	8/2003	Stamper, III	D7/510
D490,272	S	*	5/2004	Rohe	D7/510
D612,197	S	*	3/2010	Chan	D7/392.1
D751,694	S	*	3/2016	Shubin, Sr.	D24/121
D800,503	S	*	10/2017	Notheis	D7/523
D820,634	S	*	6/2018	Michie	D7/392.1
D827,377	S	*	9/2018	Silsby	D7/510
D861,432	S	*	10/2019	Ou	D7/507
2015/0021458	A1	*	1/2015	Zorovich	B29C 33/0038 249/134

* cited by examiner

Primary Examiner — Karen S Acker

Assistant Examiner — Steven B Reinholdt, Jr.

(74) *Attorney, Agent, or Firm* — Clifford H. Kraft

(57) **CLAIM**

The ornamental design for a cup lid, as shown and described.

DESCRIPTION

FIG. 1 is a top perspective view of a cup lid showing our new design.

FIG. 2 is a front view thereof.

FIG. 3 is a back view thereof.

FIG. 4 is a left view thereof.

FIG. 5 is a right view thereof.

FIG. 6 is a top view thereof; and,

FIG. 7 is a bottom view thereof.

1 Claim, 5 Drawing Sheets

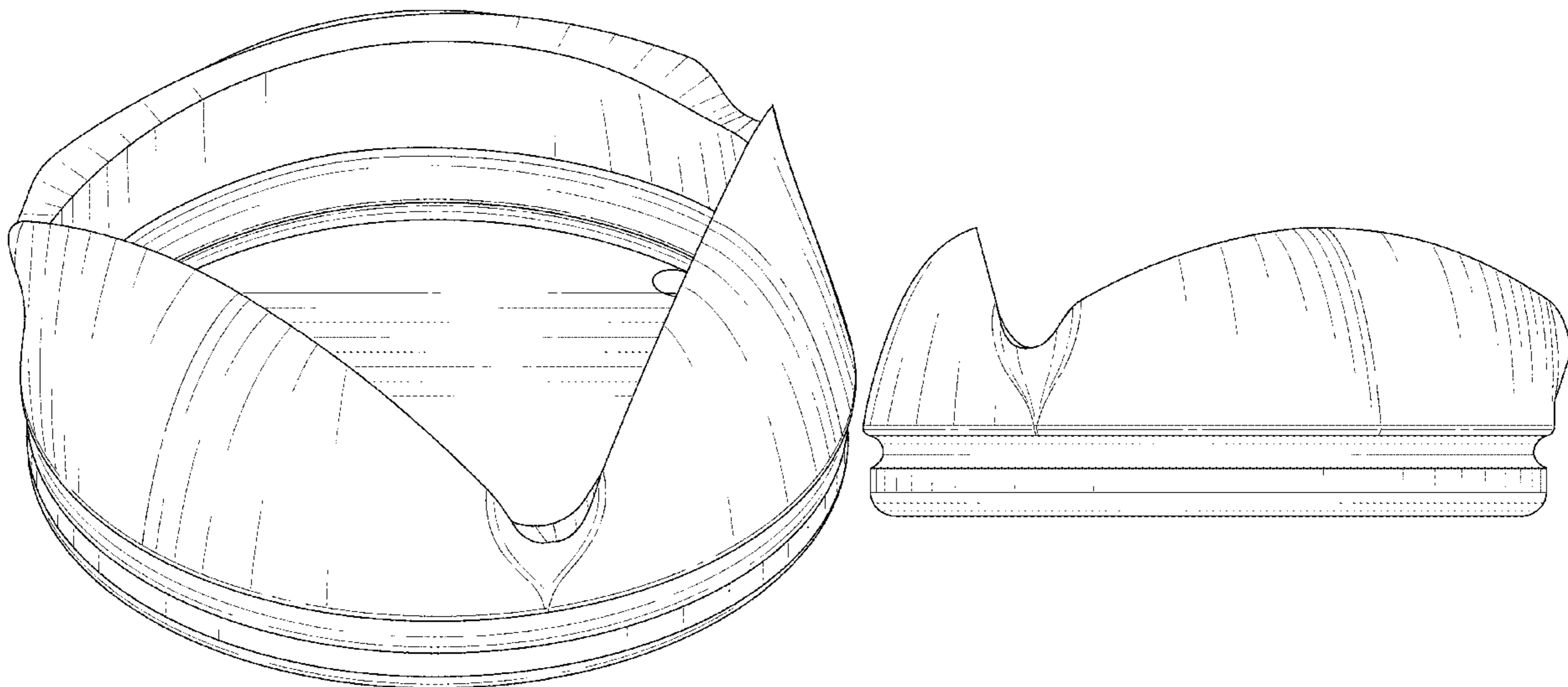

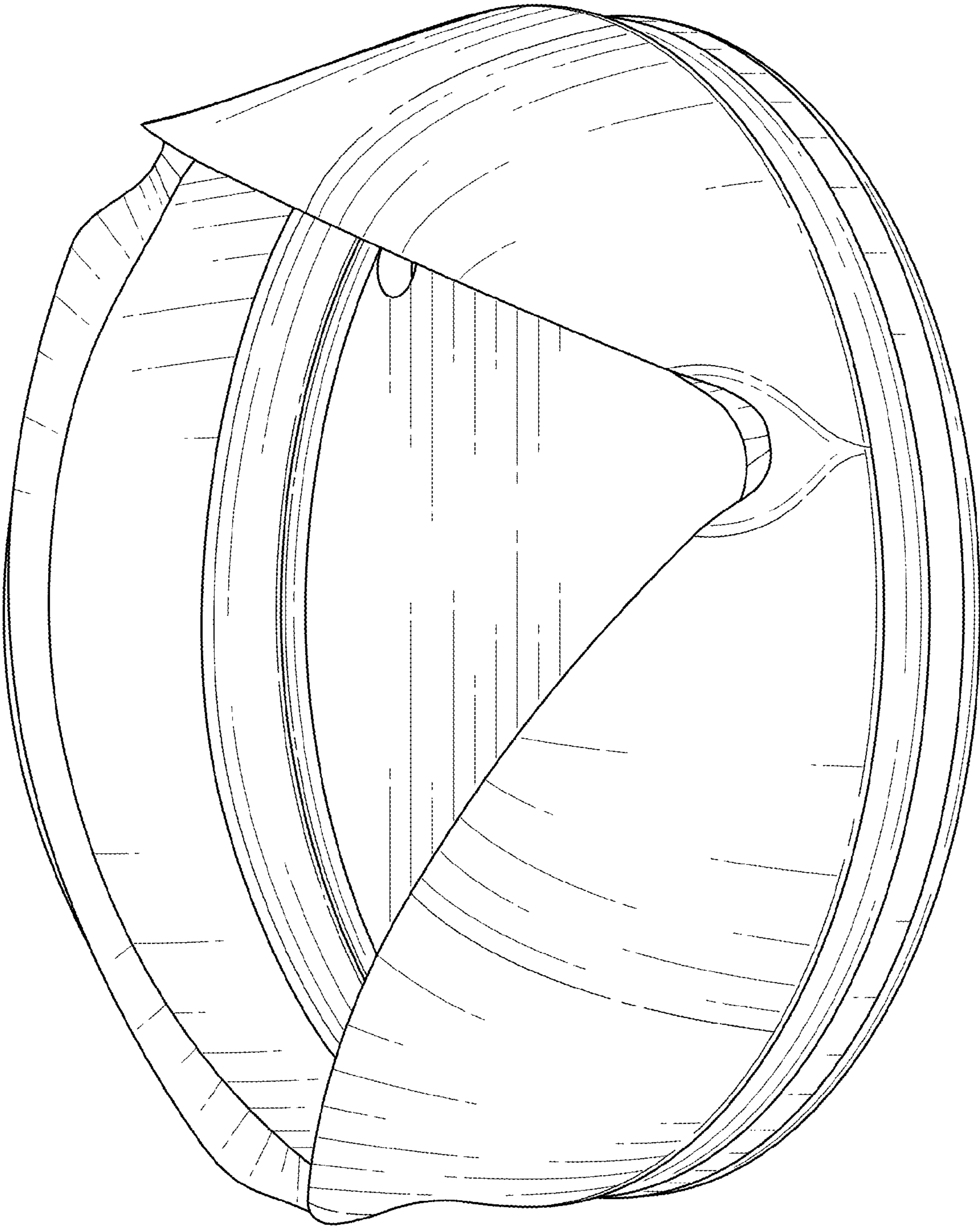

FIG. 1

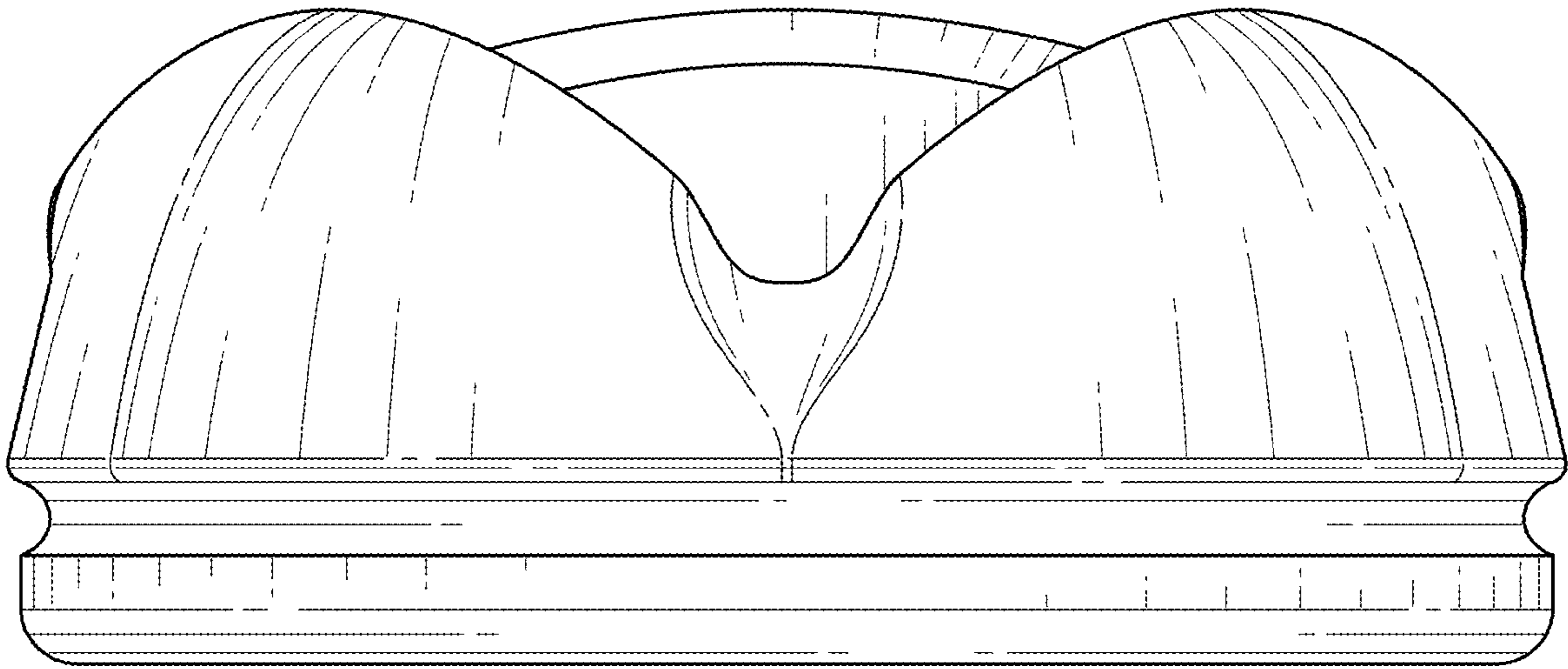

FIG. 2

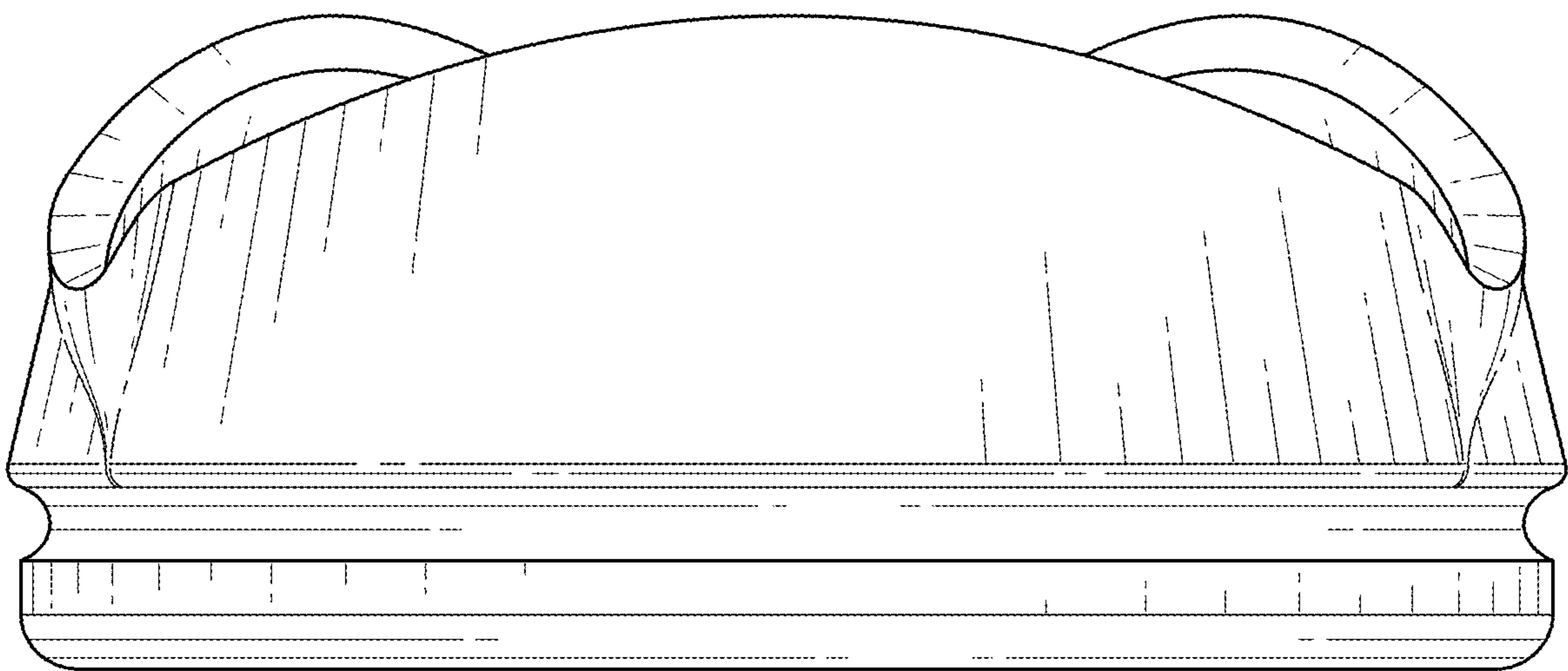

FIG. 3

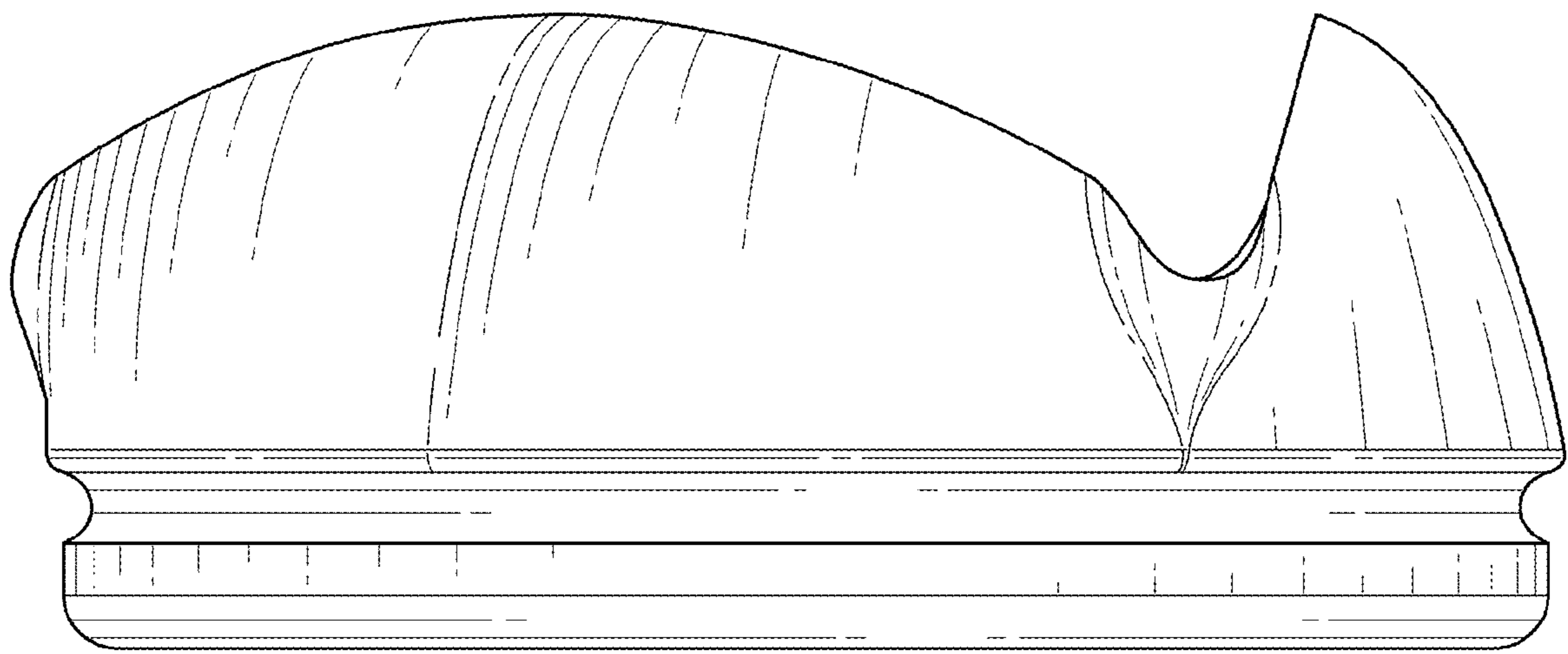

FIG. 4

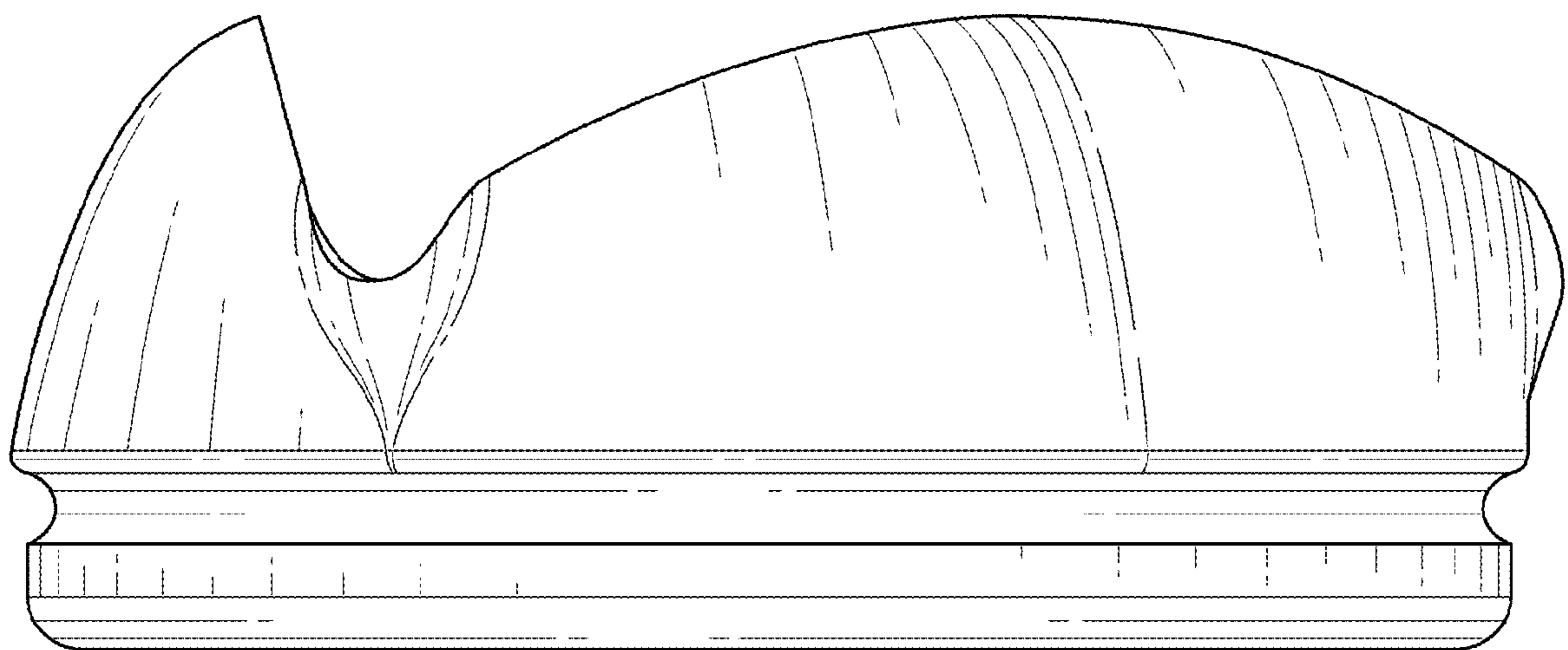

FIG. 5

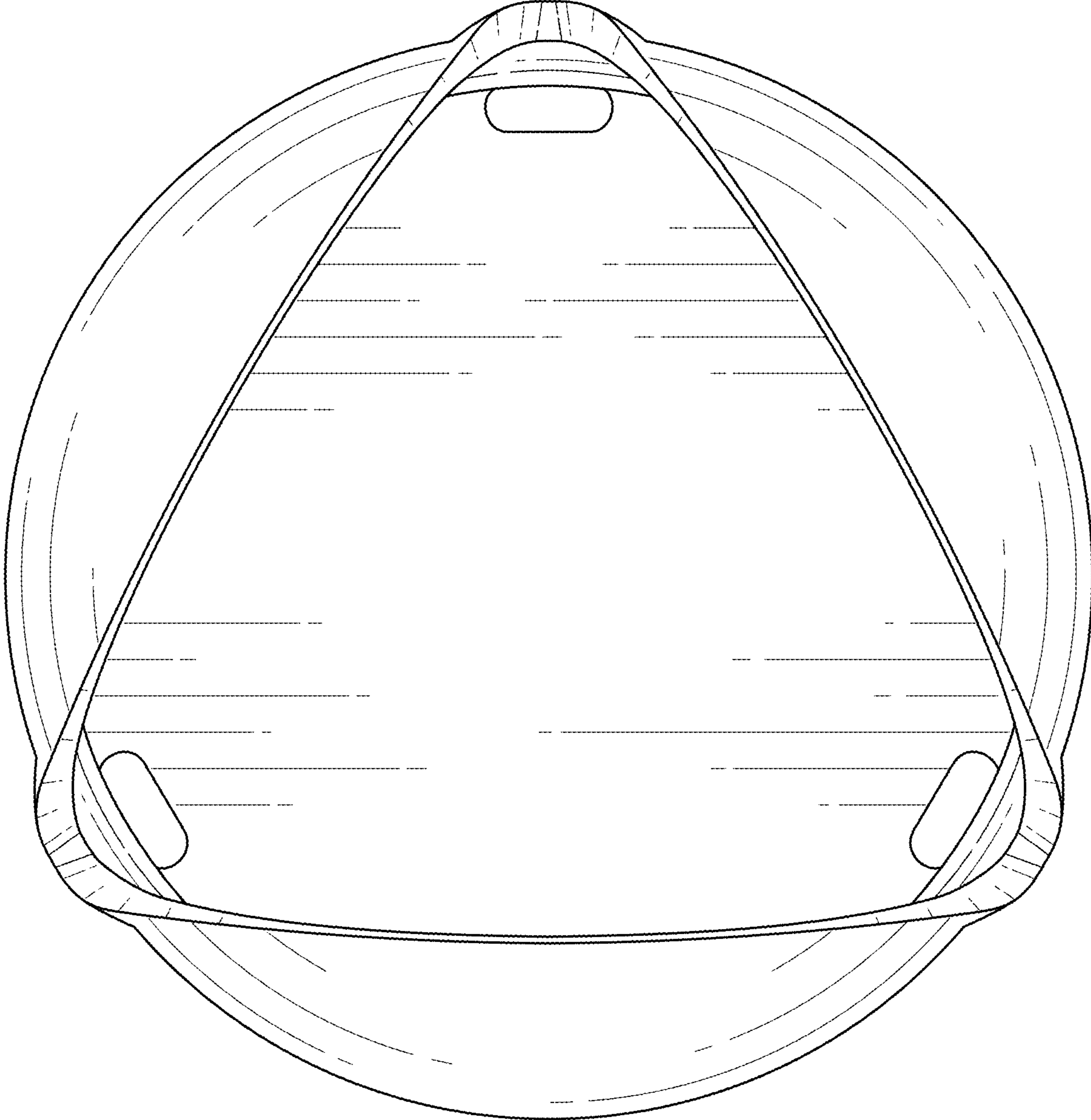

FIG. 6



FIG. 7