



US00D885111S

(12) **United States Design Patent**
Rubin et al.

(10) **Patent No.:** **US D885,111 S**

(45) **Date of Patent:** **** May 26, 2020**

(54) **FOOD WARMER**

(71) Applicant: **Trade Secret Chocolates**, Indianapolis, IN (US)

(72) Inventors: **Matthew J. Rubin**, Indianapolis, IN (US); **Adam D. Ambrecht**, Kennesaw, GA (US); **Glen D. Fuller**, Indianapolis, IN (US)

(73) Assignee: **Trade Secret Chocolates**, Indianapolis, IN (US)

(**) Term: **15 Years**

(21) Appl. No.: **29/650,730**

(22) Filed: **Jun. 8, 2018**

Related U.S. Application Data

(63) Continuation of application No. 15/923,980, filed on Mar. 16, 2018, and a continuation of application No. (Continued)

(51) **LOC (12) Cl.** **07-02**

(52) **U.S. Cl.**
USPC **D7/323**

(58) **Field of Classification Search**
USPC D7/323, 326-327, 350.1, 368, 589, 601, D7/602, 605, 709

(Continued)

(56) **References Cited**

U.S. PATENT DOCUMENTS

3,025,998 A * 3/1962 Petersen A45C 11/20
206/169
3,428,103 A * 2/1969 Walsh A47J 47/145
383/97

(Continued)

Primary Examiner — Ricky Pham

(74) *Attorney, Agent, or Firm* — C. John Brannon;
Brannon Sowers & Cracraft PC

(57) **CLAIM**

The ornamental design for a food warmer, as shown and described herein.

DESCRIPTION

FIG. 1 is a top front/right side perspective view with doors closed of the food warmer design.

FIG. 2 is a bottom rear/left side perspective view with doors closed of the food warmer design.

FIG. 3 is a front view with doors closed of the food warmer design.

FIG. 4 is a back view with doors closed of the food warmer design.

FIG. 5 is a right side view with doors closed of the food warmer design,

FIG. 6 is a left side view with doors closed of the food warmer design.

FIG. 7 is a top view with doors closed of the food warmer design.

FIG. 8 is a bottom view with doors closed of the food warmer design.

FIG. 9 is a top front/right side perspective view with doors open of the food warmer design.

FIG. 10 is a front view with doors open of the food warmer design.

FIG. 11 is a back view with doors open of the food warmer design.

FIG. 12 is a right side view with doors open of the food warmer design.

FIG. 13 is a left side view with doors open of the food warmer design.

FIG. 14 is a top view with doors open of the food warmer design; and,

FIG. 15 is a bottom view with doors open of the food warmer design.

The broken lines shown in the drawings are for illustrative purposes only and form no part of the claimed design.

1 Claim, 14 Drawing Sheets

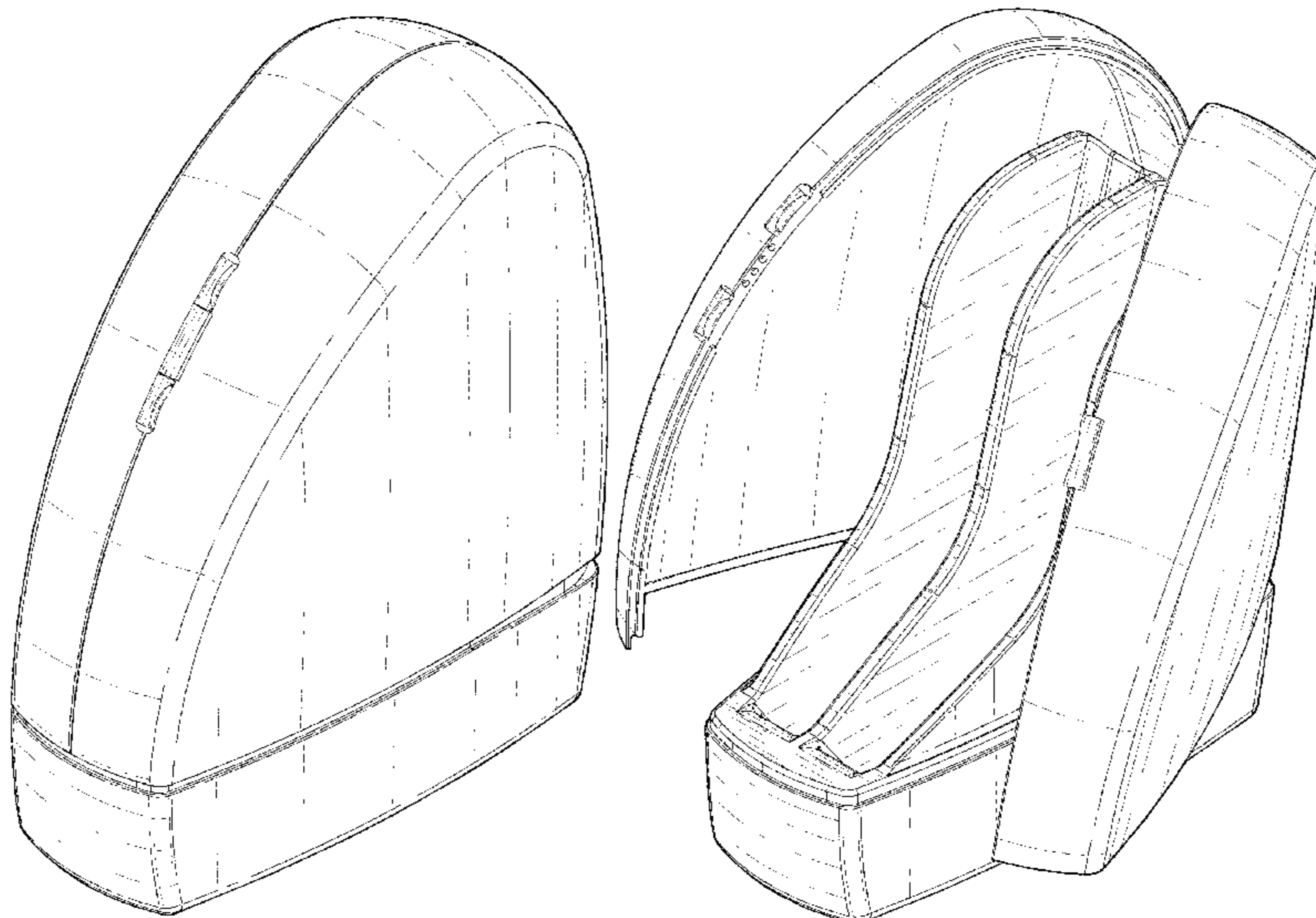

Related U.S. Application Data

15/923,971, filed on Mar. 16, 2018, and a continuation of application No. 15/923,976, filed on Mar. 16, 2018, and a continuation of application No. 15/923,974, filed on Mar. 16, 2018.

(58) **Field of Classification Search**

CPC A01J 9/08; A23G 1/20; A23L 3/10; A45C 11/20; A47J 27/04; A47J 27/004; A47J 36/24; A47J 36/2411; A47J 36/2416; A47J 36/2433; A47J 36/2438; A47J 39/00; A47J 39/006; A47J 41/00; A47J 47/145; B67D 1/0001; B67D 1/0004; B67D 1/0462; H05B 3/0004

See application file for complete search history.

(56) **References Cited**

U.S. PATENT DOCUMENTS

D227,044	S	*	5/1973	Camp	D7/709
5,096,092	A	*	3/1992	Devine	B67D 1/0462 222/105
D328,404	S	*	8/1992	Small	D7/323
5,803,317	A	*	9/1998	Wheeler	B67D 1/0004 222/105
D819,388	S	*	6/2018	Fowkes	D7/350.1
D820,643	S	*	6/2018	Mitchell	D7/589
10,420,355	B2	*	9/2019	Vulpitta	B67D 1/0001
2016/0100604	A1	*	4/2016	Rubin	A23G 1/20 426/520

* cited by examiner

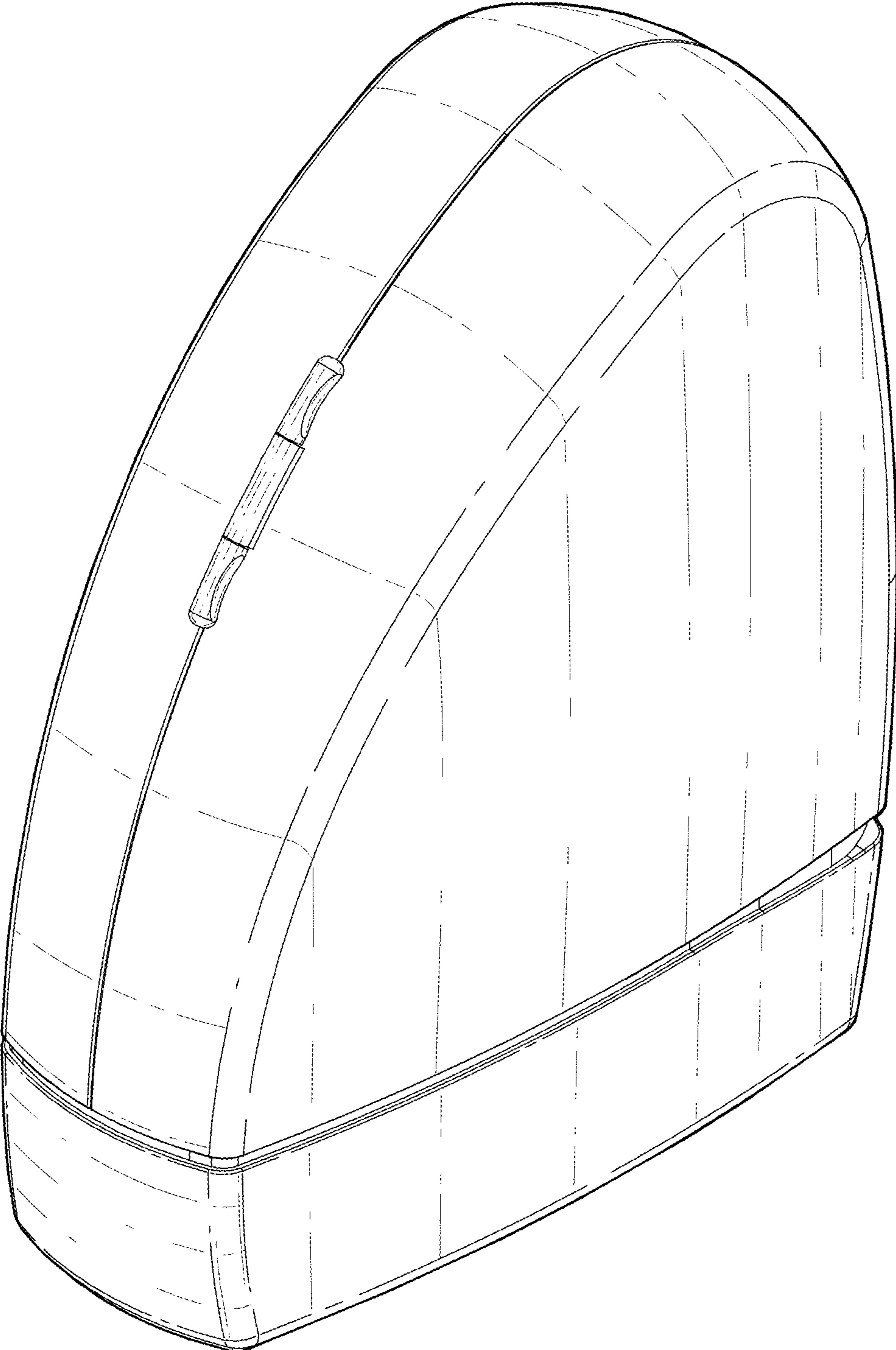

Fig. 1

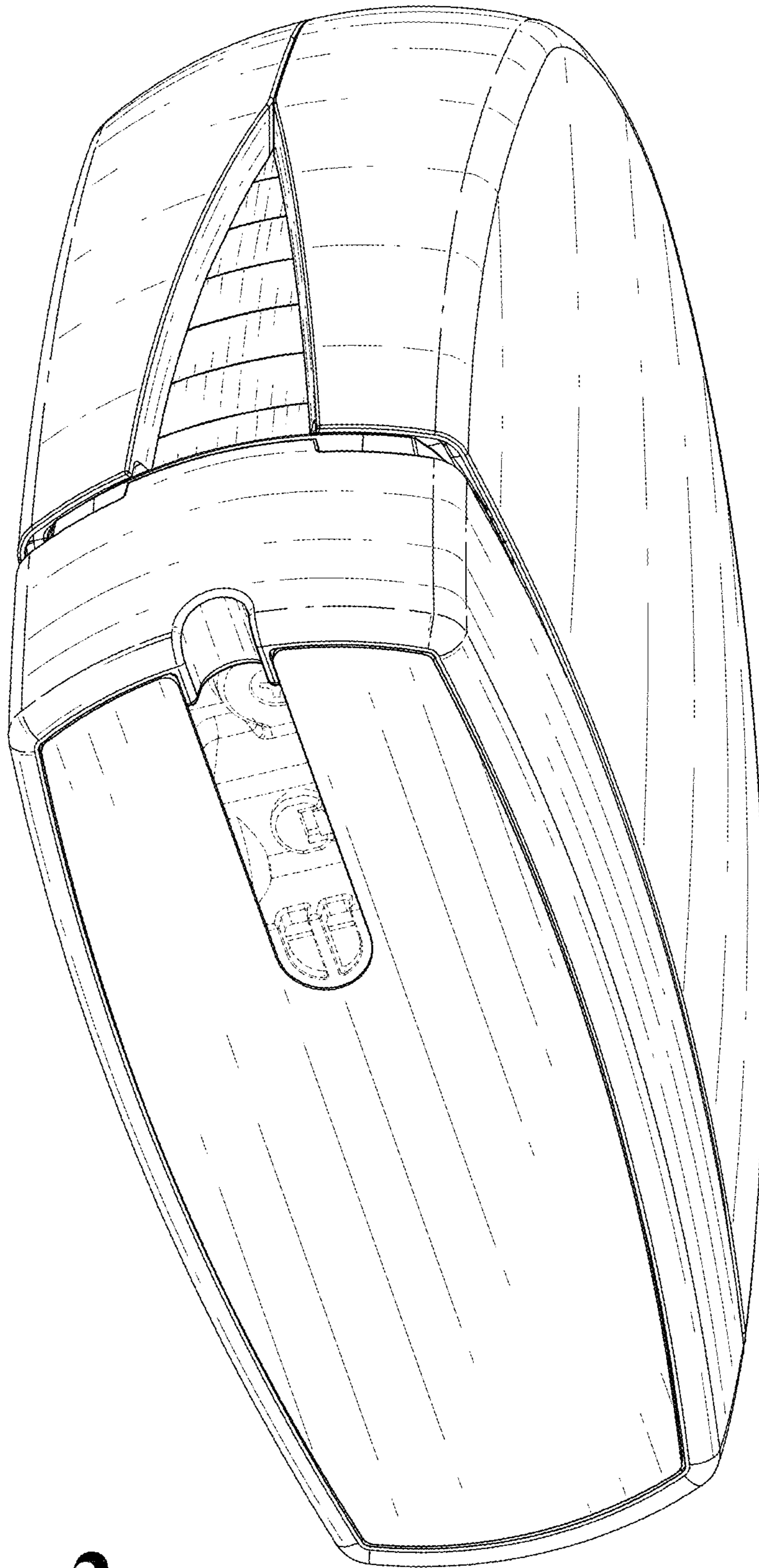

Fig. 2

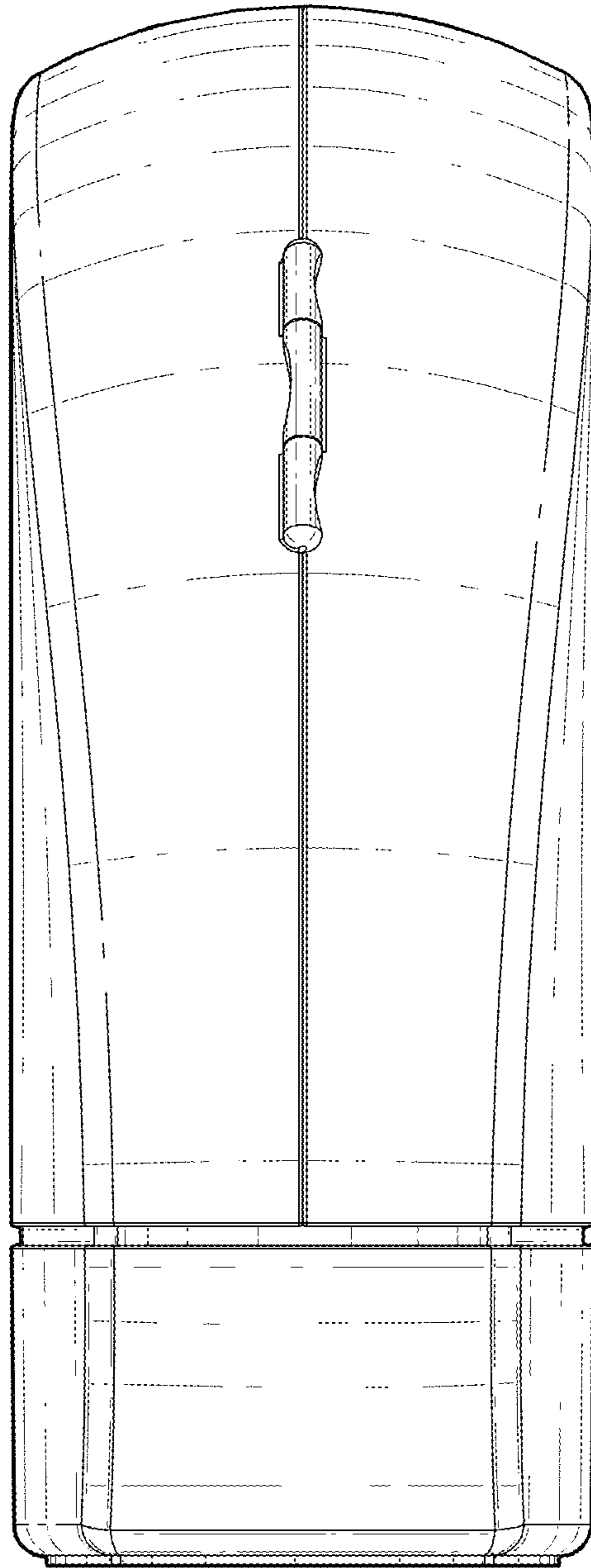

Fig. 3

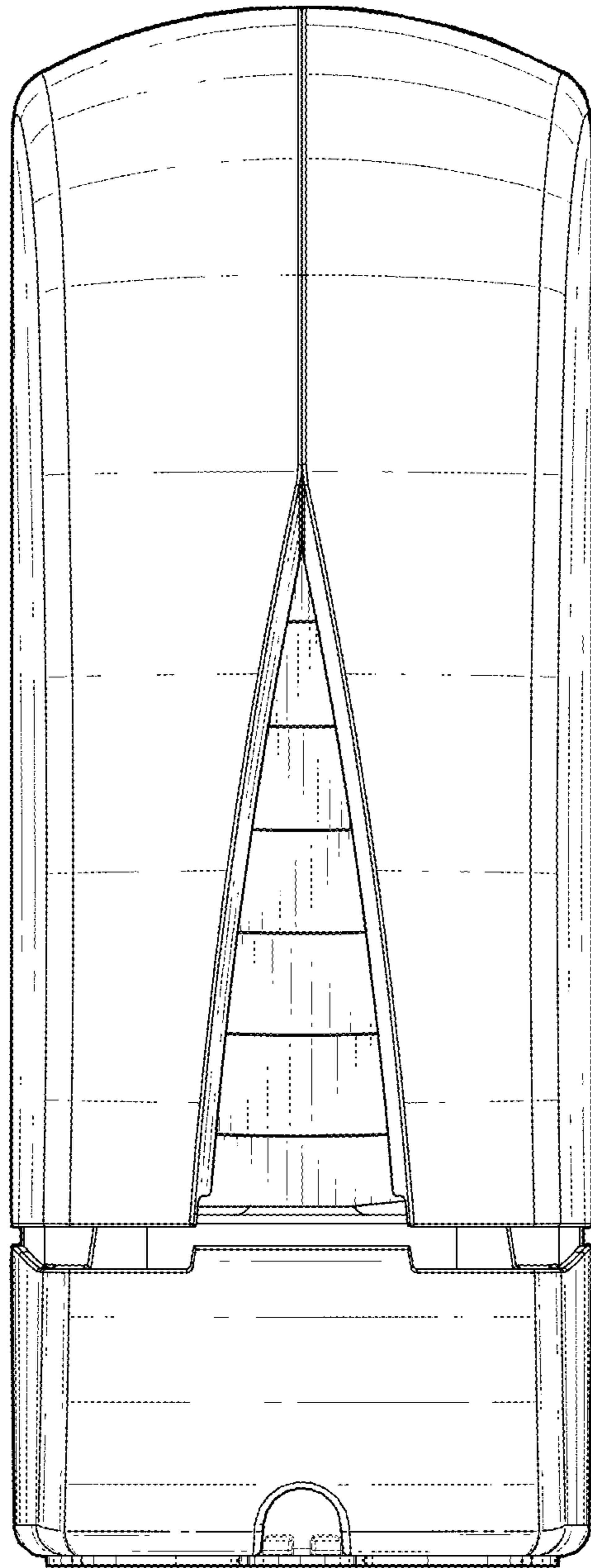

Fig. 4

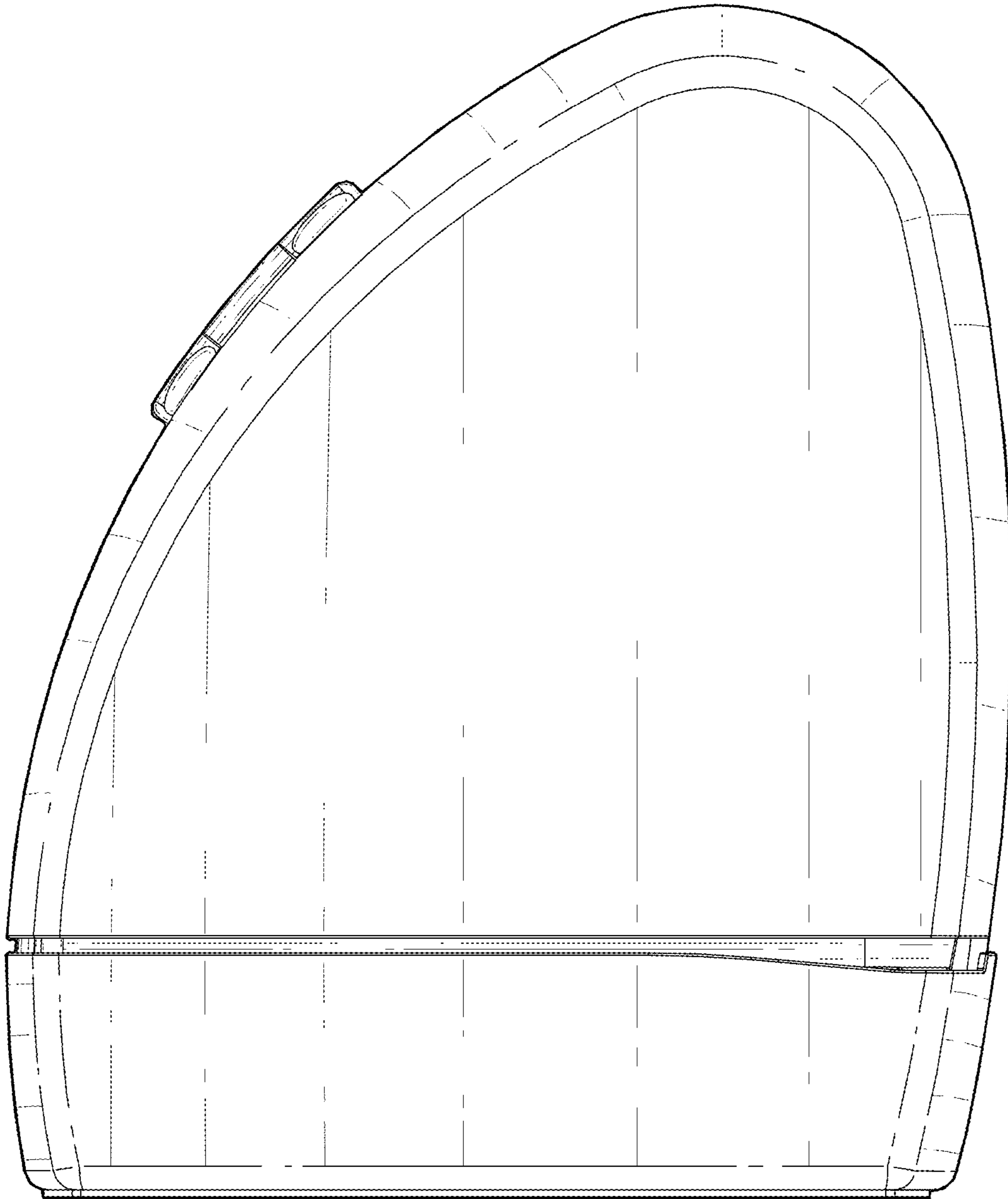

Fig. 5

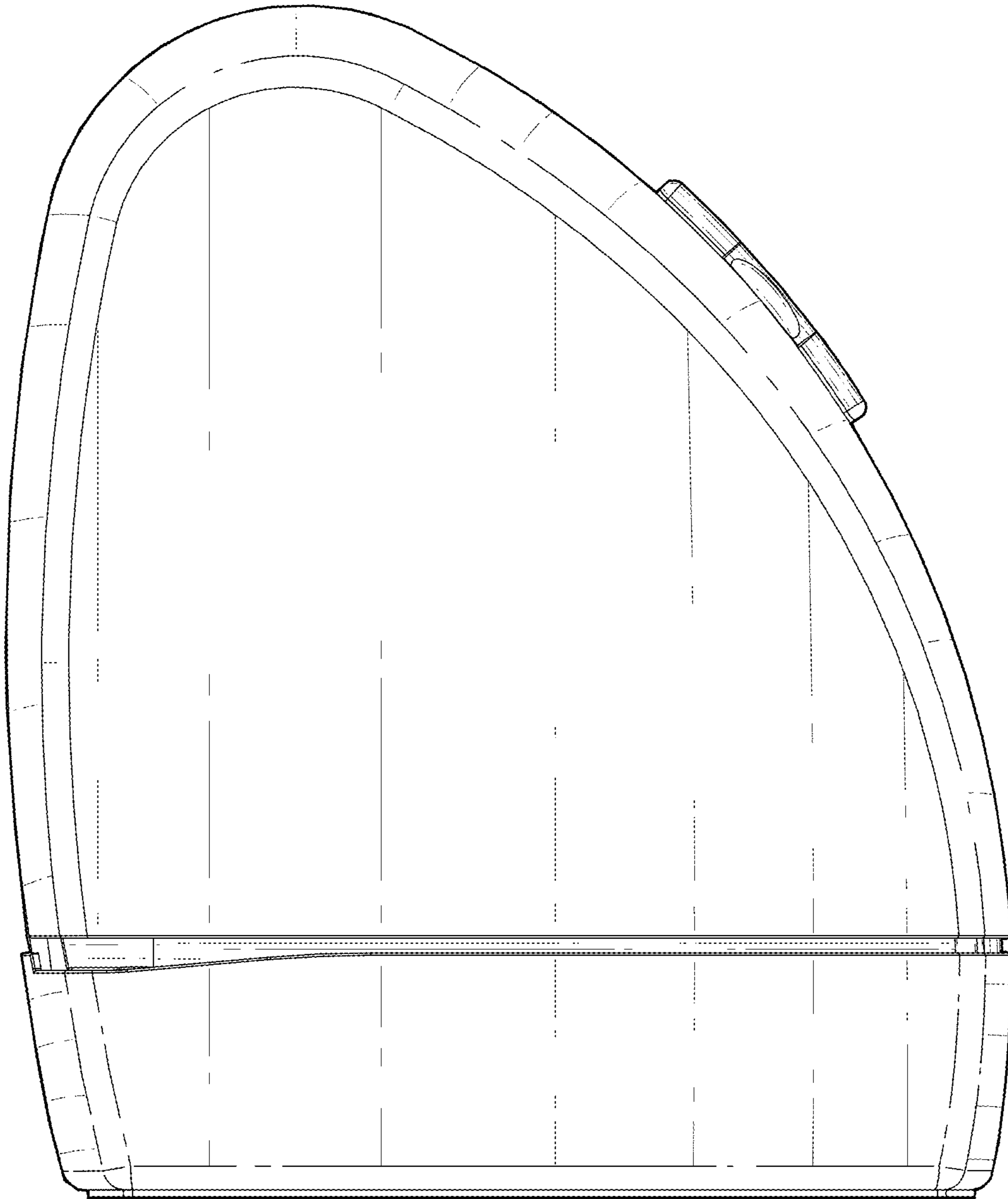

Fig. 6

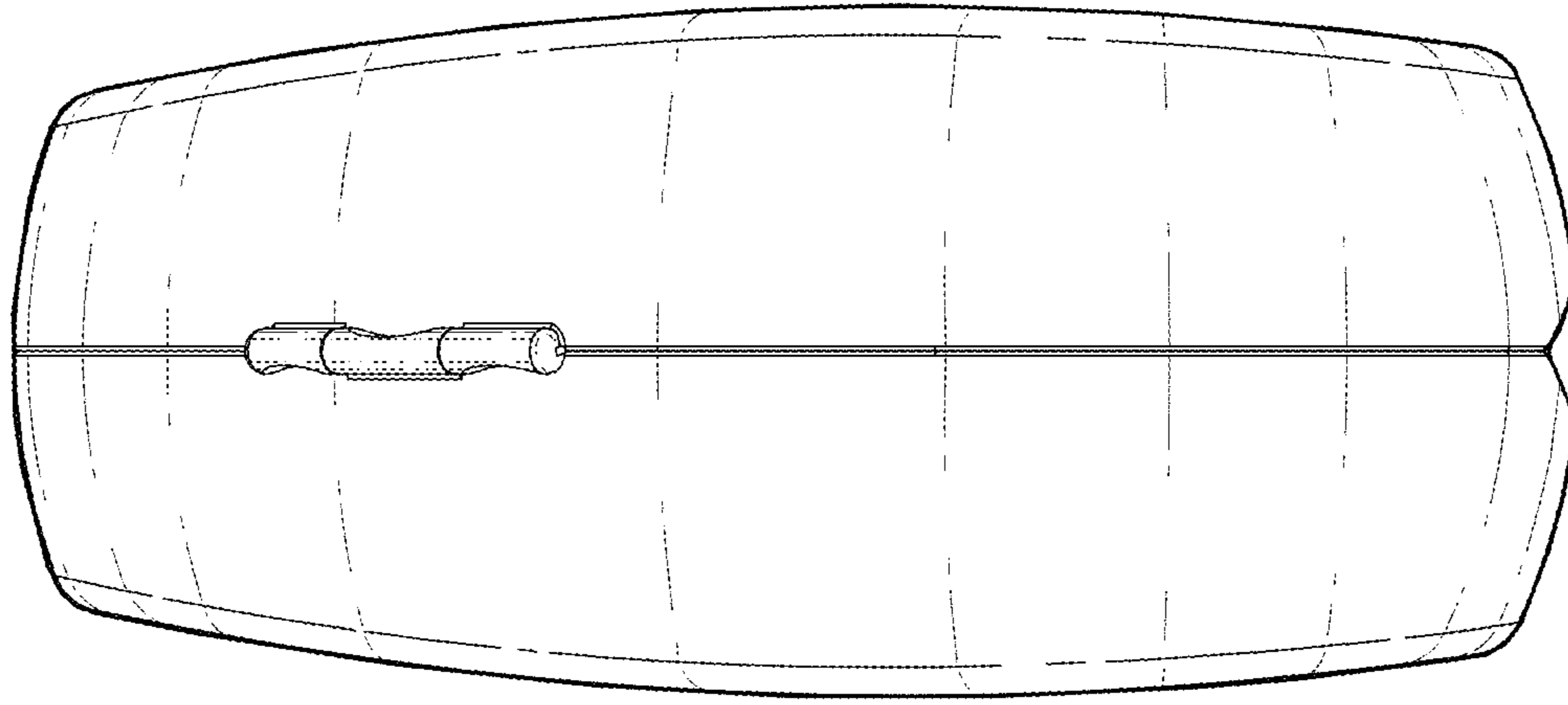

Fig. 7

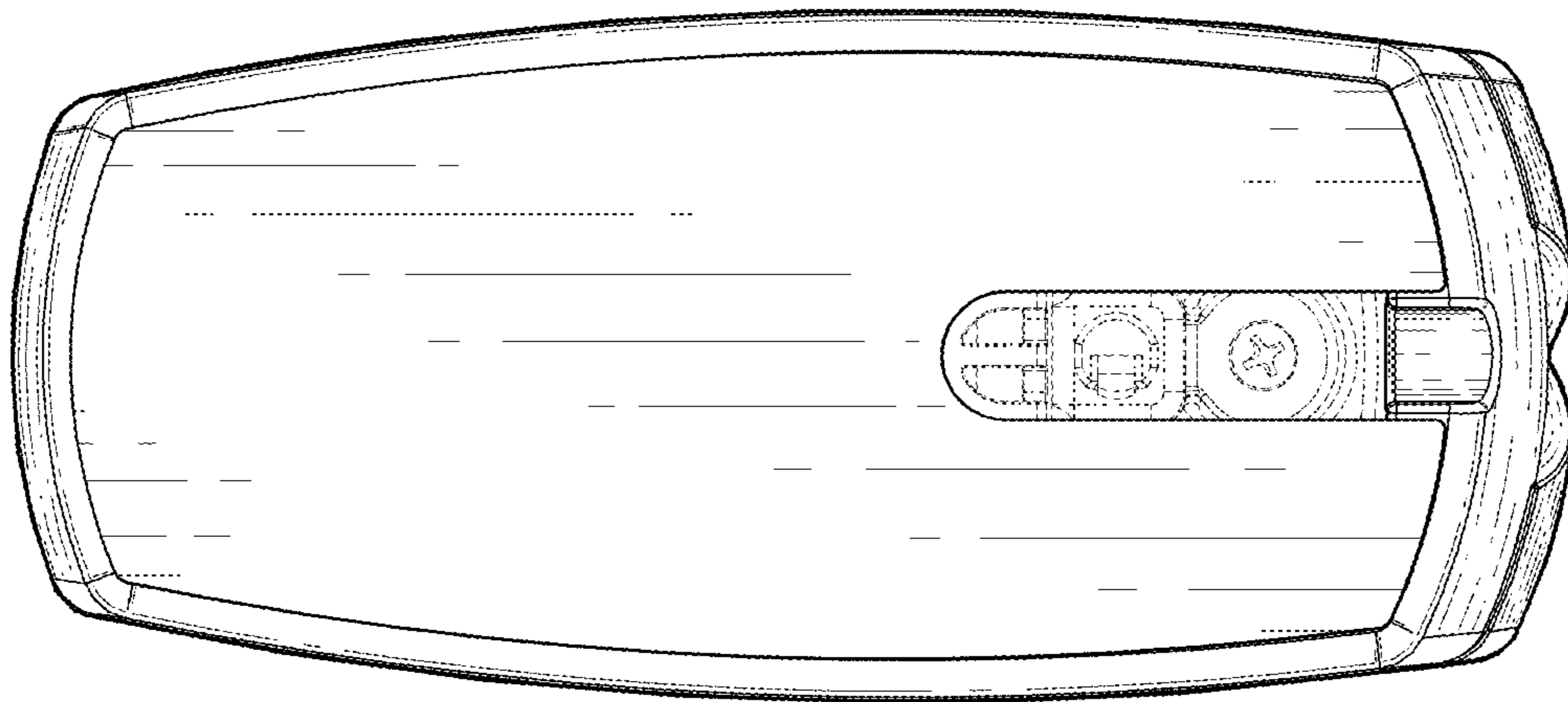

Fig. 8

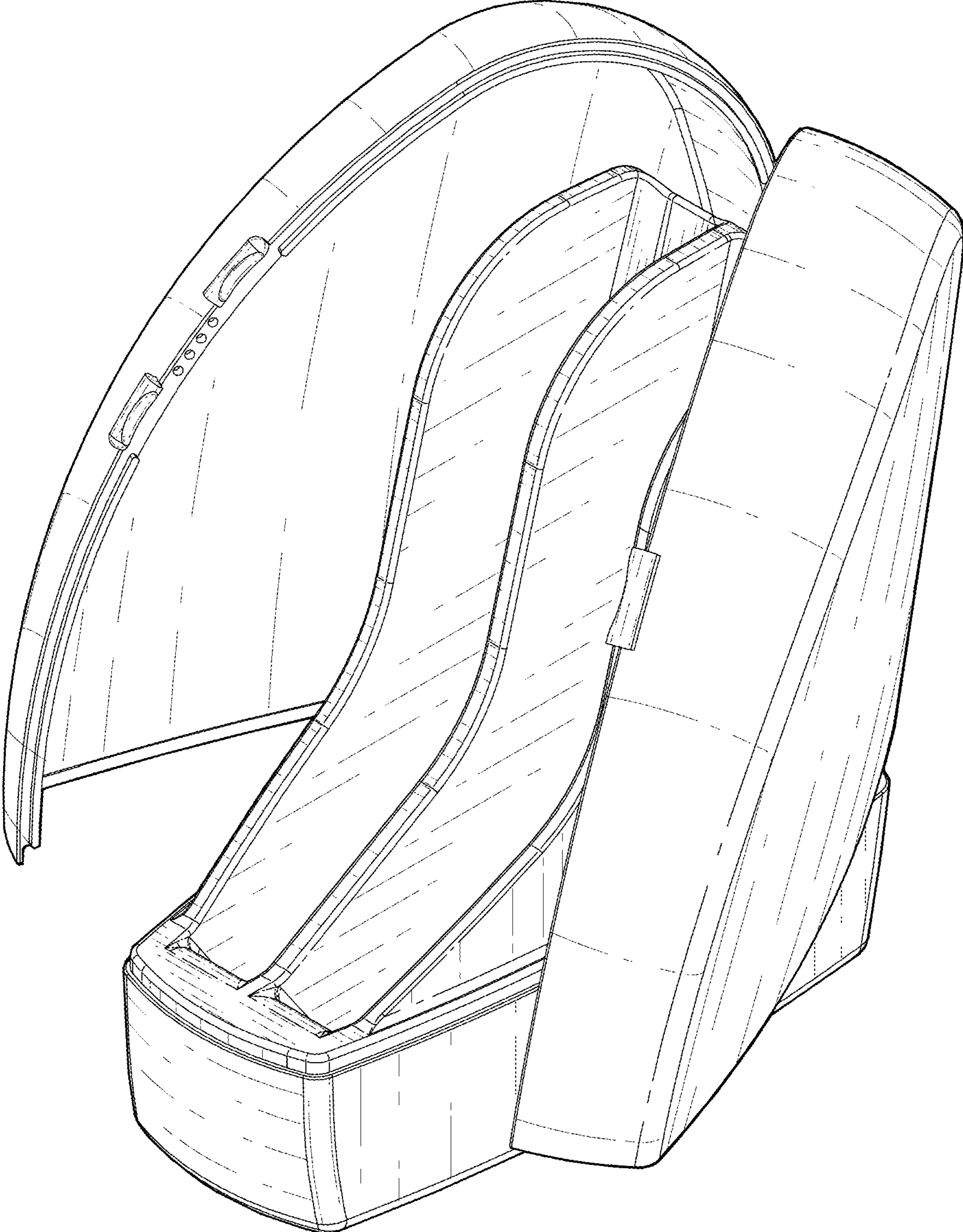

Fig. 9

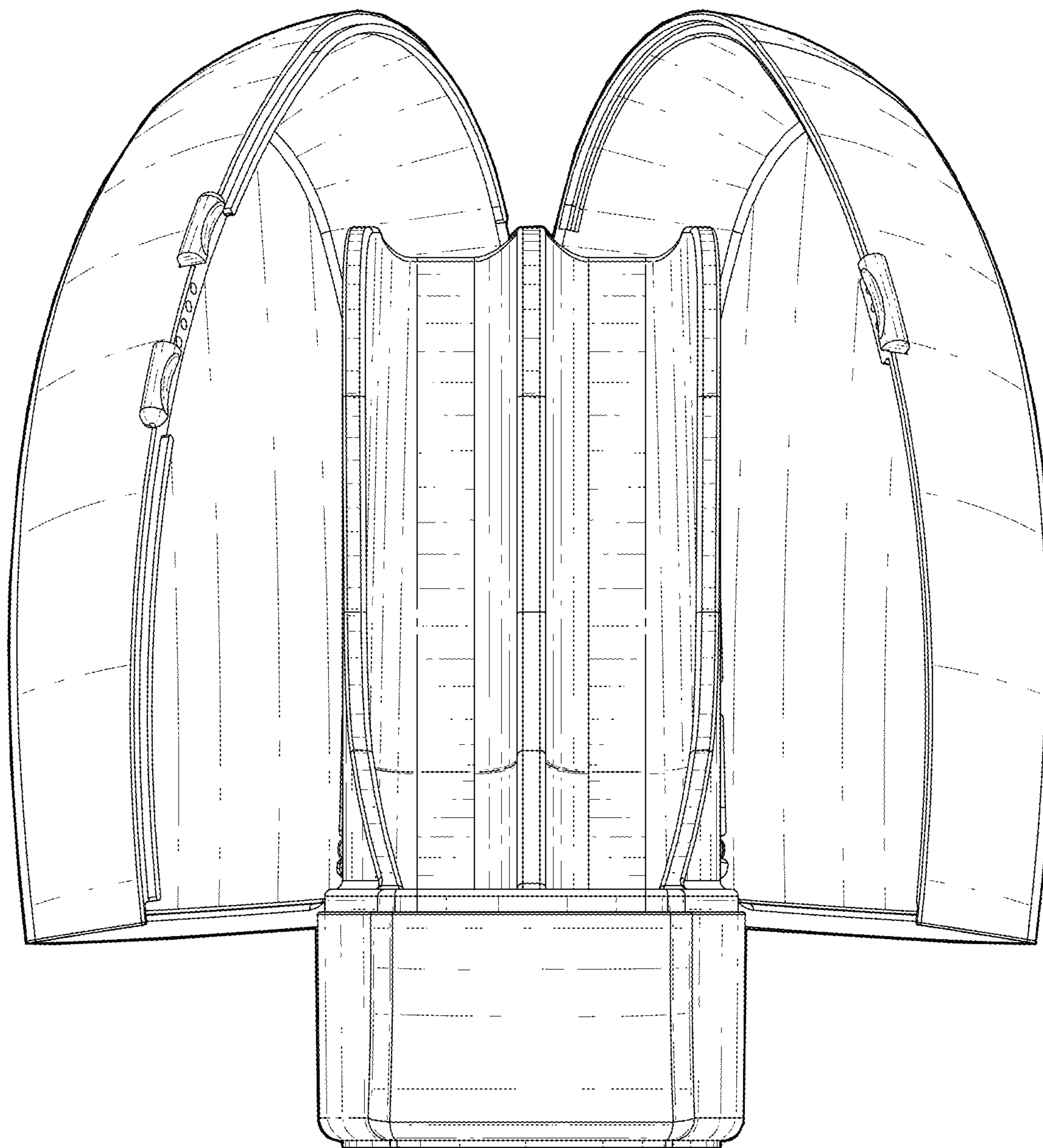

Fig. 10

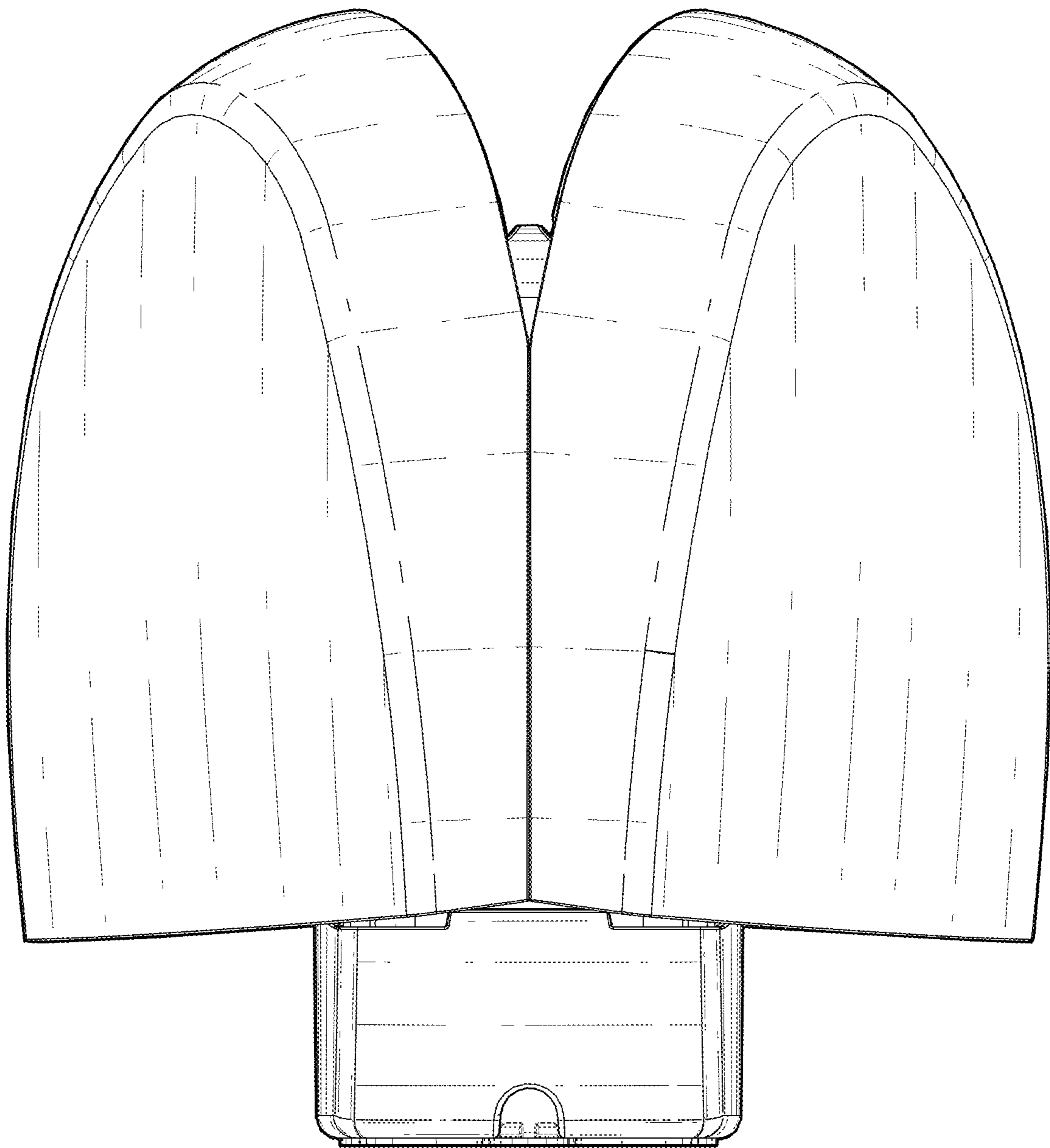

Fig. 11

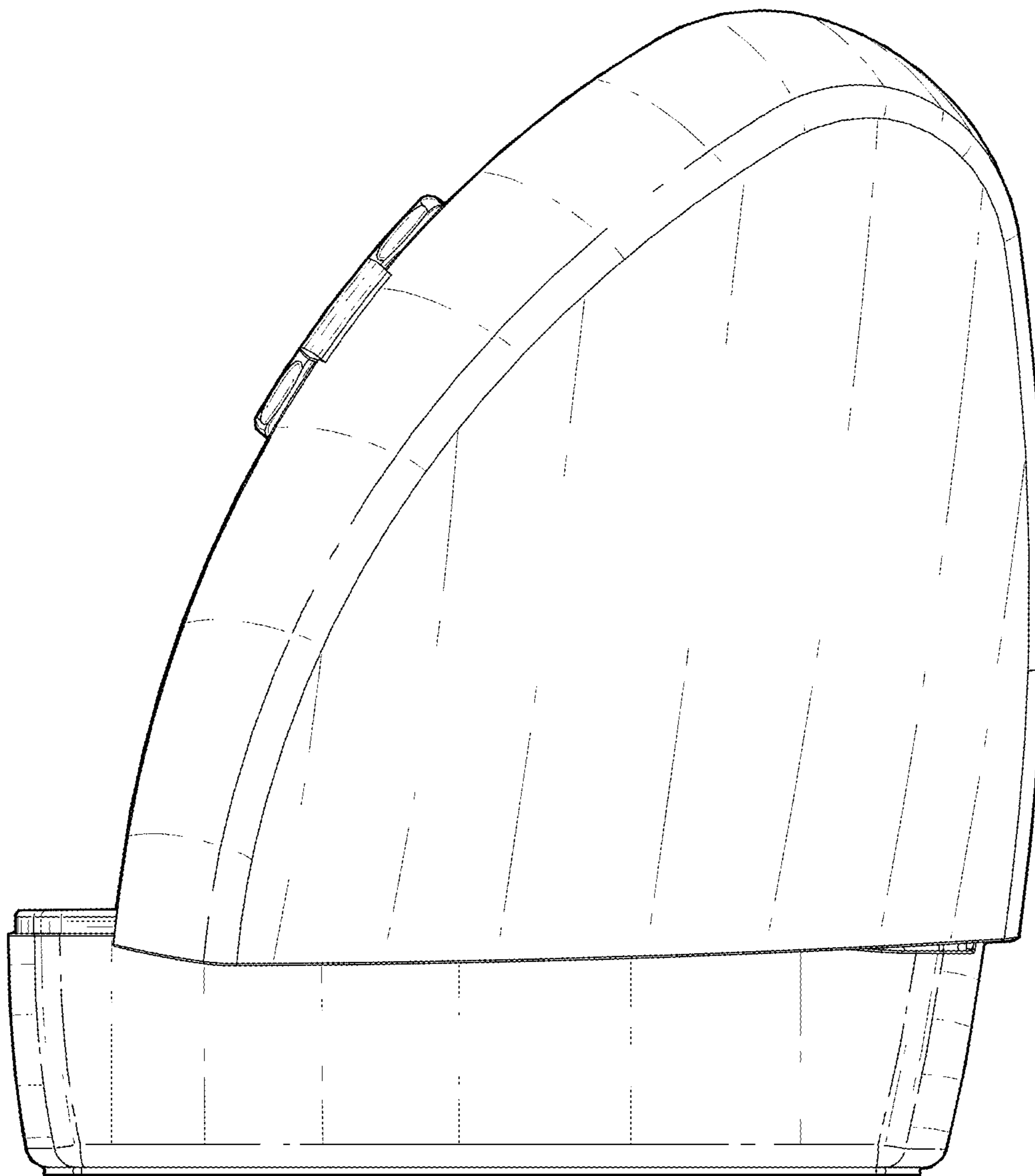

Fig. 12

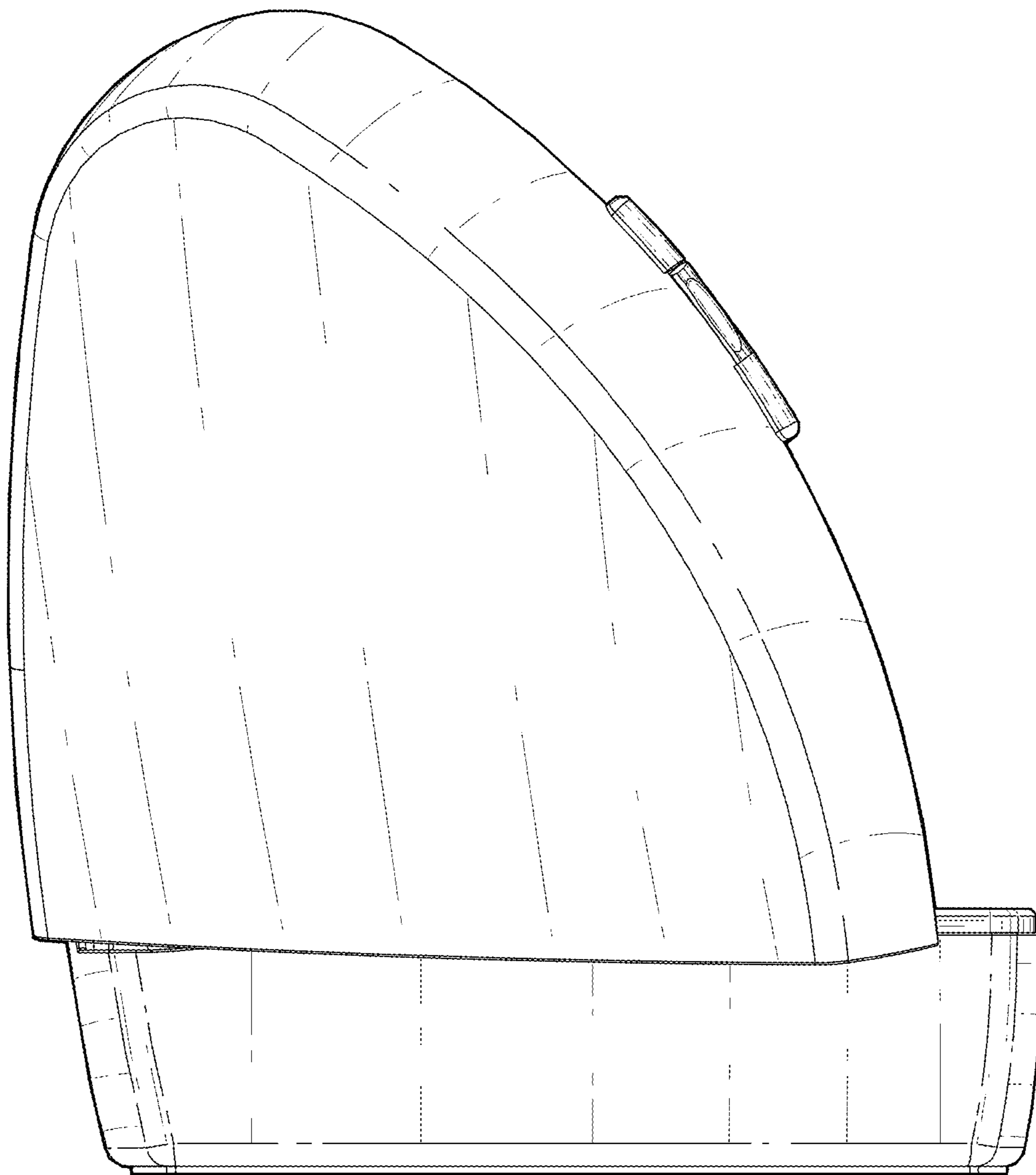

Fig. 13

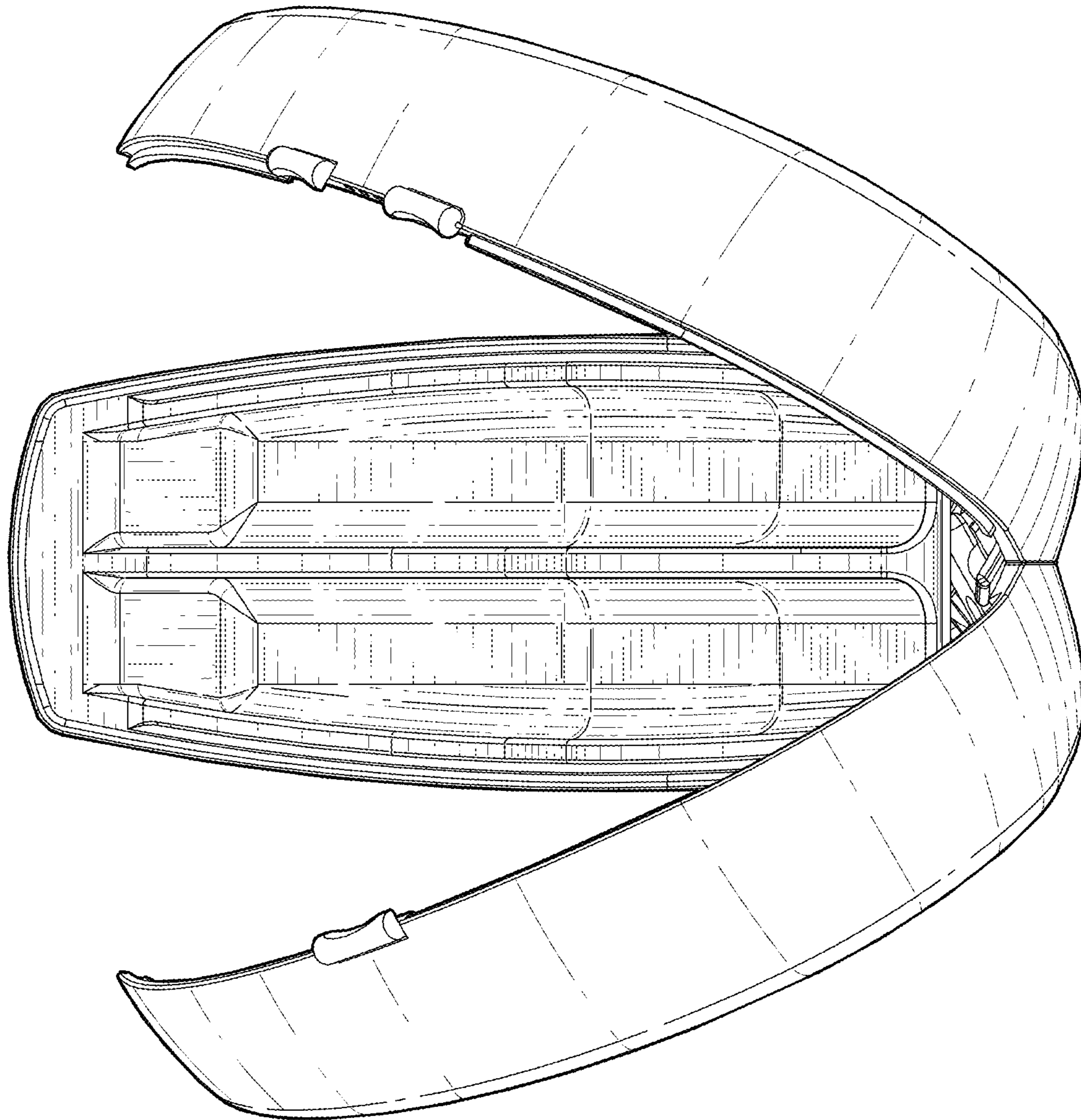

Fig. 14

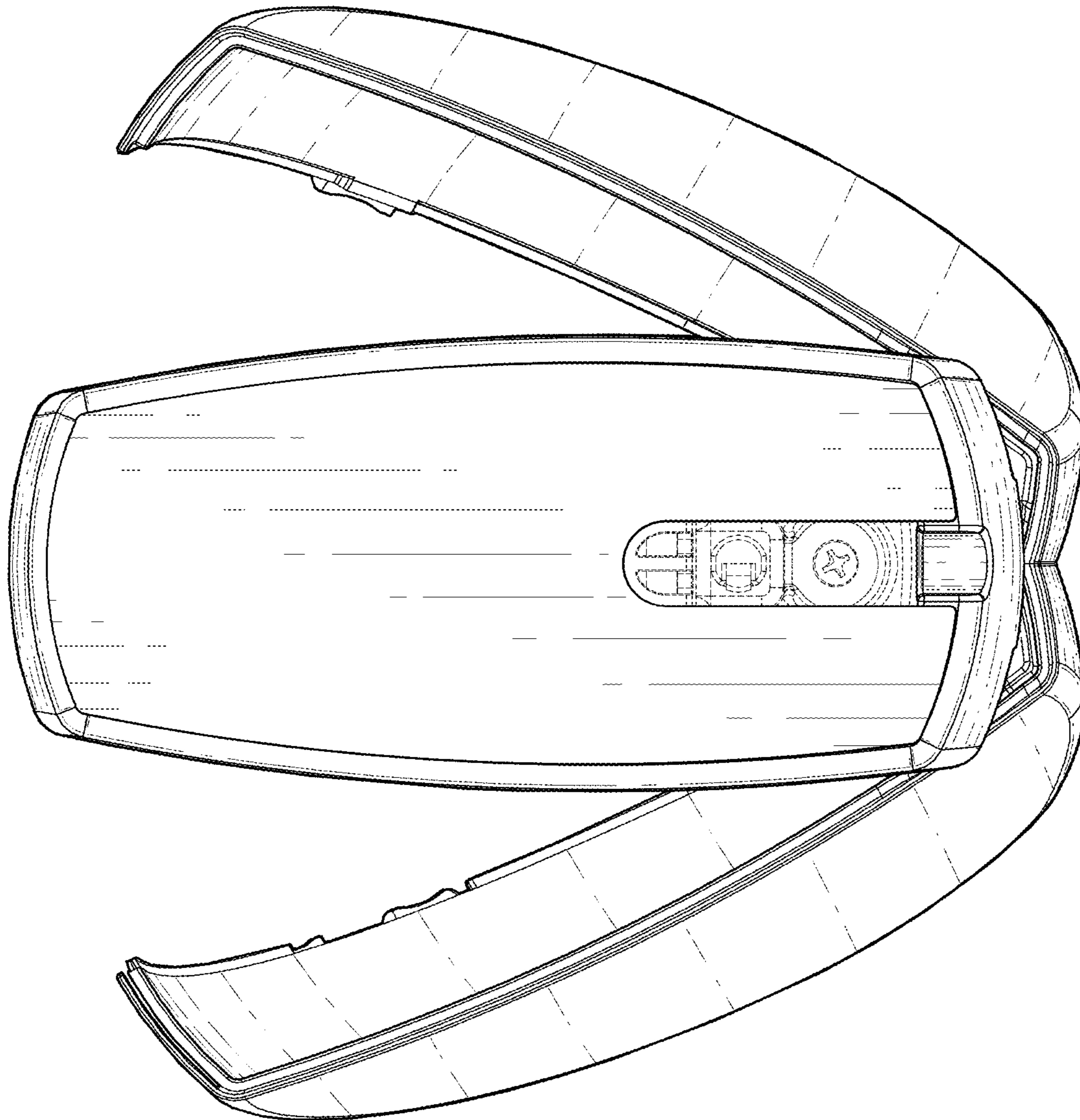

Fig. 15