



US00D885014S

(12) **United States Design Patent** (10) **Patent No.:** **US D885,014 S**
Carey et al. (45) **Date of Patent:** **** May 26, 2020**

(54) **JACKET**

(71) Applicant: **NIKE, Inc.**, Beaverton, OR (US)

(72) Inventors: **Maureen Carey**, Hillsboro, OR (US);
Mark Pimentel, Tigard, OR (US);
Ryan Tharp, Portland, OR (US)

(73) Assignee: **NIKE, Inc.**, Beaverton, OR (US)

(**) Term: **15 Years**

(21) Appl. No.: **29/683,641**

(22) Filed: **Mar. 14, 2019**

(51) **LOC (12) Cl.** **02-02**

(52) **U.S. Cl.**
USPC **D2/853**

(58) **Field of Classification Search**
USPC D2/865, 853, 839, 831
See application file for complete search history.

(56) **References Cited**

U.S. PATENT DOCUMENTS

- 2,439,382 A * 4/1948 De Grazia A42B 1/048
2/84
- 2,581,366 A * 1/1952 De Grazia A42B 1/045
2/203
- 4,334,325 A * 6/1982 Walkuski A41D 3/00
2/202
- D323,733 S * 2/1992 Shalom D2/831
- D374,332 S * 10/1996 Brister D2/881
- D406,936 S * 3/1999 Sivret D2/865
- D478,708 S * 8/2003 Miros D2/831
- D479,902 S * 9/2003 Brown D2/831
- D626,725 S * 11/2010 Snyder D2/830
- D633,692 S 3/2011 Lawrence et al.
- 8,438,665 B2 * 5/2013 Roemer A41D 3/00
2/84
- D695,491 S * 12/2013 Hawkins D2/750

- D700,418 S 3/2014 Borovicka et al.
- D701,368 S * 3/2014 Borovicka D2/831
- D704,924 S * 5/2014 Roberts D2/831
- D705,522 S 5/2014 Borovicka et al.
- D714,526 S 10/2014 Ingram
- D719,722 S 12/2014 Bublak
- D746,551 S * 1/2016 Ingram D2/839
- D747,075 S 1/2016 Ingram

(Continued)

OTHER PUBLICATIONS

Mountain Hardwear Quasar Pullover posted to campsaver.com. Available date: Aug. 29, 2014 [site visited: Sep. 16, 2019]. Available: <<https://www.campsaver.com/mountain-hardwear-quasar-pullover-mens.html>> (Year: 2014).*

(Continued)

Primary Examiner — Kevin K Rudzinski

(74) *Attorney, Agent, or Firm* — Banner & Witcoff, Ltd.

(57) **CLAIM**

The ornamental design for a jacket, as shown and described.

DESCRIPTION

FIG. 1 is a front perspective view of a jacket showing our new design in an in-use configuration; FIG. 2 is a rear perspective view thereof; FIG. 3 is a front view thereof; FIG. 4 is a rear view thereof; FIG. 5 is a left side view thereof; FIG. 6 is a right side view thereof; and, FIG. 7 is a top view thereof.

The broken lines immediately adjacent to the shaded area define the bounds of the claimed design and form no part thereof. The broken lines depicting the remainder of the jacket show features that form no part of the claimed design.

1 Claim, 7 Drawing Sheets

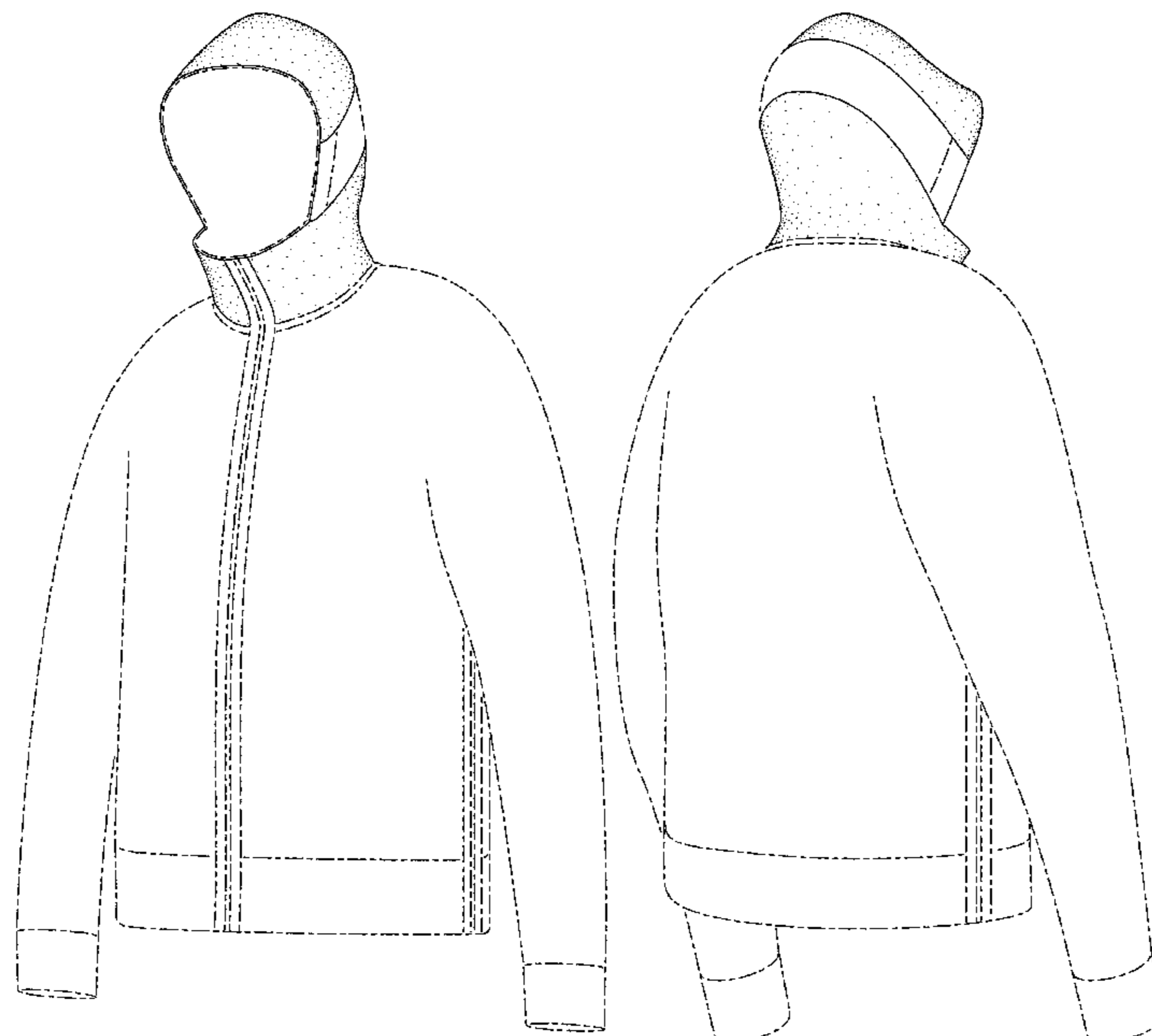

(56)

References Cited

U.S. PATENT DOCUMENTS

D756,602 S	5/2016	Darmour	
D757,398 S	5/2016	Ingram	
D758,047 S	6/2016	Burlo	
D758,698 S	6/2016	Darmour	
D758,699 S *	6/2016	Darmour	D2/831
D762,346 S	8/2016	Lomax	
D764,742 S	8/2016	Criss	
D767,855 S *	10/2016	Maguire	D2/828
D770,136 S	11/2016	Darmour	
D775,788 S	1/2017	Darmour	
D781,027 S	3/2017	Zheng	
D783,944 S	4/2017	Lomax	
D785,906 S *	5/2017	Darmour	D2/731
D786,537 S	5/2017	Ingram	
D787,161 S *	5/2017	Darmour	D2/840
D789,042 S	6/2017	Lomax	
D790,807 S	7/2017	Darmour	
D791,440 S *	7/2017	Ingram	D2/828
D791,444 S	7/2017	Darmour	
D791,445 S	7/2017	Darmour	
D792,680 S *	7/2017	Ingram	D2/828
D799,167 S	10/2017	Carey et al.	
D799,168 S	10/2017	Carey et al.	
D808,121 S	1/2018	Noll	
D827,249 S *	9/2018	Darmour	D2/728
D843,689 S	3/2019	Kinnear	
D854,805 S	7/2019	Link et al.	
2002/0095712 A1 *	7/2002	Fayle	A41D 3/00 2/84
2006/0162048 A1	7/2006	Blutstein	
2013/0042384 A1 *	2/2013	Mitchell	A42B 1/048 2/84
2015/0327612 A1	11/2015	Bublitz	
2018/0049499 A1	2/2018	Noll	
2018/0184729 A1	7/2018	Rybak	

OTHER PUBLICATIONS

Dynafit Beast Hybrid Jacket posted to backcountry.com. Available date: Dec. 20, 2018 [site visited Mar. 2, 2020]. Available: <<https://www.backcountry.com/dynafit-beast-hybrid-jacket-mens?irgwc=1&ircid=5311&irpid=10078&clickid=xoQXbIleMxyOWZT05-R4sULoUknXVWwuiQ6%3Axk0#the-wall>> (Year: 2018).*

Nike Footwear Catalog, 2008 Fall Jordan Apparel, p. 3, published date unknown, but prior to the filing date of the present application, NIKE, Inc., USA.

Nike Footwear Catalog, 2010 Spring Indie Footwear and Apparel, p. 3, published May 2009, NIKE, Inc., USA.

Nike Footwear Catalog, 2010 Spring Indie Footwear and Apparel, p. 4, published May 2009, NIKE, Inc., USA.

Nike Footwear Catalog, 2010 Spring Jordan Apparel and Accessories, p. 53, published May 2009, NIKE, Inc., USA.

Nike Footwear Catalog, 2011 Spring Performance Apparel, p. 15, published May 2010, NIKE, Inc., USA.

Nike Footwear Catalog, 2011 Fall Jordan Catalog, p. 33, published Nov. 2010, NIKE, Inc., USA.

Nike Footwear Catalog, 2015 Spring Soccer Specialty, p. 43, published May 14, 2014, NIKE, Inc., USA.

Nike Footwear Catalog, 2015 Spring Nike Running Specialty, p. 64, published May 14, 2014, NIKE, Inc., USA.

Nike Footwear Catalog, 2016 Spring Allocated Styles Footwear Apparel NA, p. 106, published May 2015, NIKE, Inc., USA.

Nike Footwear Catalog, 2016 Spring City Specialty Better Apparel Equipment NA, p. 7, published May 2015, NIKE, Inc., USA.

Nike Footwear Catalog, 2016 Spring Dept Store Apparel Equipment Best NA, p. 5, published May 2015, NIKE, Inc., USA.

Nike Footwear Catalog, 2016 Spring Dept Store Apparel Equipment Best NA, p. 18, published May 2015, NIKE, Inc., USA.

Nike Footwear Catalog, 2016 Spring Territory Sporting Goods Apparel Equipment Best NA, p. 63, published May 2015, NIKE Inc., USA.

Nike Footwear Catalog, 2016 Spring Territory Sporting Goods Apparel Equipment Best NA, p. 102, published May 2015, NIKE Inc., USA.

Nike Footwear Catalog, 2016 Spring Territory Sporting Goods Apparel Equipment Best NA, p. 242, published May 2015, NIKE, Inc., USA.

Nike Footwear Catalog, 2016 Fall Department Store Apparel and Equipment Best NA, p. 39, published Nov. 2015, NIKE, Inc., USA.

Nike Footwear Catalog, 2016 Fall Sporting Goods Apparel Equipment Best NA, p. 22, published Nov. 2015, NIKE, Inc., USA.

Nike Footwear Catalog, 2017 Spring City Specialty Apparel Equipment T11 NA, p. 258, published May 2016, NIKE, Inc., USA.

Nike Footwear Catalog, 2017 Spring Jordan Apparel Equipment NA, p. 14, published May 2016, NIKE, Inc., USA.

Nike Footwear Catalog, 2017 Spring Lacrosse Specialty Footwear Apparel Equipment NA, p. 102, published May 2016, NIKE, Inc., USA.

Nike Footwear Catalog, 2017 Spring Strategic Sporting Goods Apparel Equipment Best NA, p. 40, published May 2016, NIKE, Inc., USA.

Nike Footwear Catalog, 2017 Spring Territory Sporting Goods Apparel Equipment Best NA, p. 41, published May 2016, NIKE, Inc., USA.

Nike Footwear Catalog, 2017 Spring Strategic Sporting Goods Apparel Equipment Best NA, p. 244, published May 2016, NIKE, Inc., USA.

Nike Footwear Catalog, 2017 Spring Strategic Sporting Goods Apparel Equipment Best NA, p. 369, published May 2016, NIKE, Inc., USA.

Nike Footwear Catalog, 2018 Spring Lacrosse Specialty Catalog NA, p. 34, published May 25, 2017, NIKE, Inc., USA.

Nike Footwear Catalog, 2018 Spring Lacrosse Specialty Catalog NA, p. 38, published May 25, 2017, NIKE, Inc., USA.

Nike Footwear Catalog, 2018 Spring GC Account Catalog, p. 46, published May 17, 2017, NIKE, Inc., USA.

Nike Footwear Catalog, 2012 Spring Womens' Performance Apparel, p. 9, published May 2011, NIKE, Inc., USA.

Nike Footwear Catalog, 2010 Spring Jordan Apparel and Accessories, p. 54, published May 2009, NIKE, Inc., USA.

Nike Footwear Catalog, 2011 Spring Performance Apparel, p. 16, published May 2010, NIKE, Inc., USA.

Nike Footwear Catalog, 2016 Spring Allocated Styles Footwear Apparel NA, p. 104, published May 2015, NIKE, Inc., USA.

Nike Footwear Catalog, 2016 Spring Allocated Styles Footwear Apparel NA, p. 107, published May 2015, NIKE, Inc., USA.

Nike Footwear Catalog, 2016 Fall Athletic Specialty Apparel and Equipment NA, p. 319, published Nov. 2015, NIKE, Inc., USA.

Nike Footwear Catalog, 2016 Fall Athletic Specialty Apparel and Equipment NA, p. 321, published Nov. 2015, NIKE, Inc., USA.

Nike Footwear Catalog, 2016 Fall Jordan Apparel and Equipment NA, p. 18, published Nov. 2015, NIKE, Inc., USA.

Nike Footwear Catalog, 2016 Fall Running Specialty, p. 103, published Nov. 2015, NIKE, Inc., USA.

Nike Footwear Catalog, 2016 Fall Strategic Sporting Goods Apparel Equipment Catalog NA, p. 22, published Nov. 2015, NIKE, Inc., USA.

Nike Footwear Catalog, 2017 Spring Athletic Specialty Apparel Equipment Best NA, p. 154, published May 2016, NIKE, Inc., USA.

Nike Footwear Catalog, 2017 Spring Boutique Apparel Equipment NA, p. 26, published May 2016, NIKE, Inc., USA.

Nike Footwear Catalog, 2017 Spring Boutique Apparel Equipment NA, p. 145, published May 2016, NIKE, Inc., USA.

Nike Footwear Catalog, 2017 Spring MLB Men's Apparel Final 2, p. 28, published May 2016, NIKE, Inc., USA.

Nike Footwear Catalog, 2017 Fall GC Account Catalog, p. 49, published Nov. 9, 2016, NIKE, Inc., USA.

Nike Footwear Catalog, 2017 Fall GC Account Catalog, p. 120, published Nov. 9, 2016, NIKE, Inc., USA.

Nike Footwear Catalog, 2019 Spring Basketball, p. 120, published date unknown, but prior to the filing date of the present application, NIKE, Inc., USA.

(56)

References Cited

OTHER PUBLICATIONS

Nike Footwear Catalog, Mens Nike Athletic Dept Classics Apparel SP12, p. 3, published date unknown, but prior to the filing date of the present application, NIKE, Inc., USA.

Nike Footwear Catalog, Mens Nike Athletic Dept Classics Apparel SP12, p. 8, published date unknown, but prior to the filing date of the present application, NIKE, Inc., USA.

Nike Footwear Catalog, 2012 Spring Men's Performance Apparel, p. 8, published date unknown, but prior to the filing date of the present application, NIKE, Inc., USA.

Nike Footwear Catalog, 2012 Spring Men's Performance Apparel, p. 18, published date unknown, but prior to the filing date of the present application, NIKE, Inc., USA.

Nike Footwear Catalog, 2018 Spring GC Account Catalog, p. 21, published May 17, 2017, NIKE, Inc., USA.

Nike Footwear Catalog, 2012 Spring Women's Performance Apparel, p. 9, published date unknown, but prior to the filing date of the present application, NIKE, Inc., USA.

Nike Footwear Catalog, 2015 Fall Boutique NA, p. 55, published Nov. 2014, NIKE, Inc., USA.

Nike Windrunner Tech Icon Hoodie [Online], retrieved [Jul. 18, 2019], retrieved from Amazon.com [Internet] <URL:https://www.amazon.com/NIKE-Sportswear-Windrunner-Sweatshirt-805144-091/dp/B005OBZBCW/ref=sr_1_1?keywords=nike+tech+windrunner&qid=1563472561&s=gateway&sr=8-1>; 1 color sheet, No date but published prior to initial filing of application.

Nike Sportswear Windrunner [Online], retrieved [Jun. 4, 2019], retrieved from Nike.com [Internet] <URL:<https://www.nike.com/t/sportswear-windrunner-womens-woven-windbreaker-v2TER47W/883495-366>>; 2 color sheets, No date but published prior to initial filing of application.

Nike-Clothing Nike Elite Stripe Performance Full Zip Hoodie Men Clothes 645087-480 [Online], retrieved [Jun. 5, 2019], retrieved from StepToRun.com [Internet] <URL:<http://www.steptorun.com/shop/product.php?productid=11707>>; 3 color sheets, No date but published prior to initial filing of application.

* cited by examiner

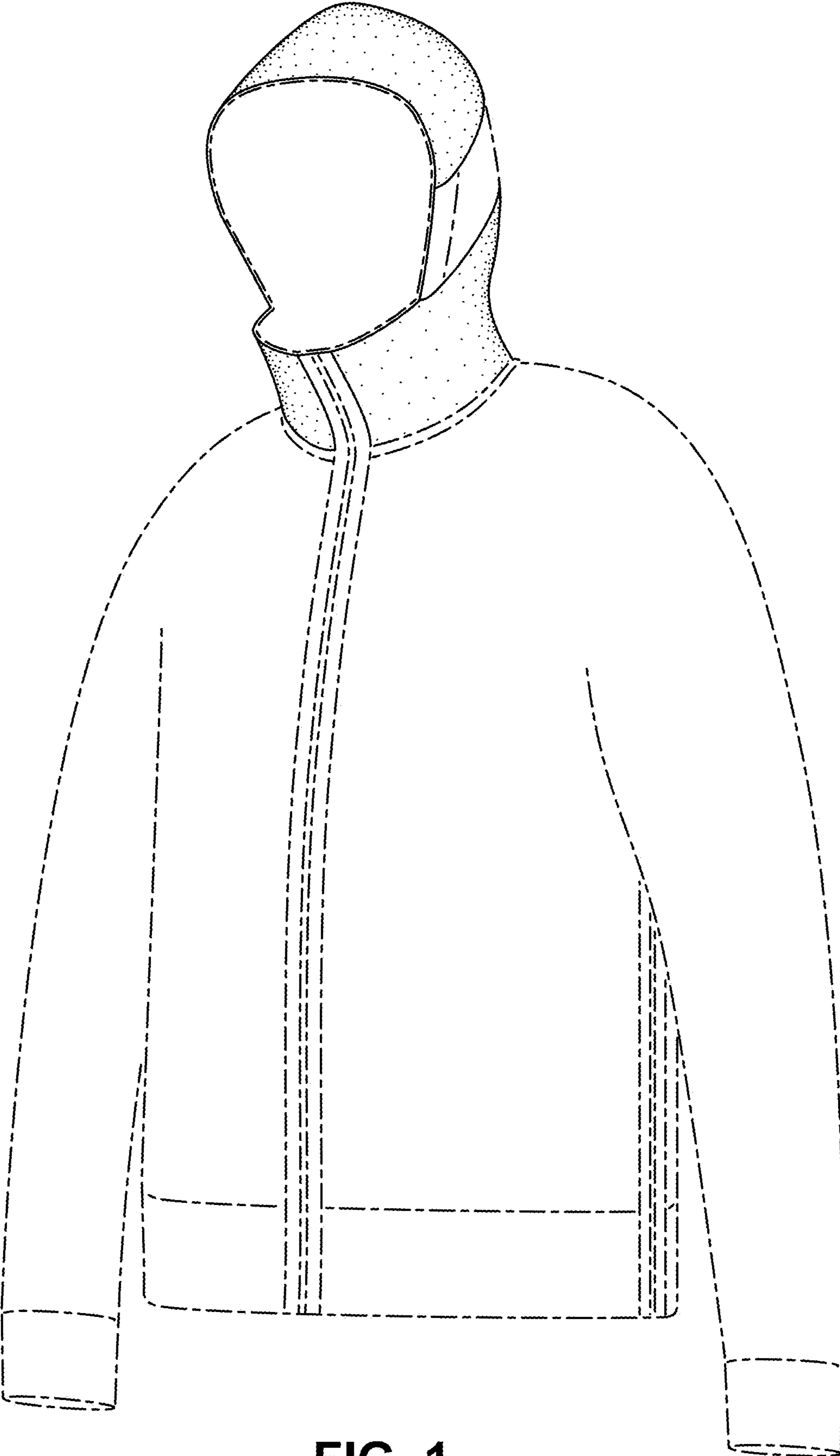

FIG. 1

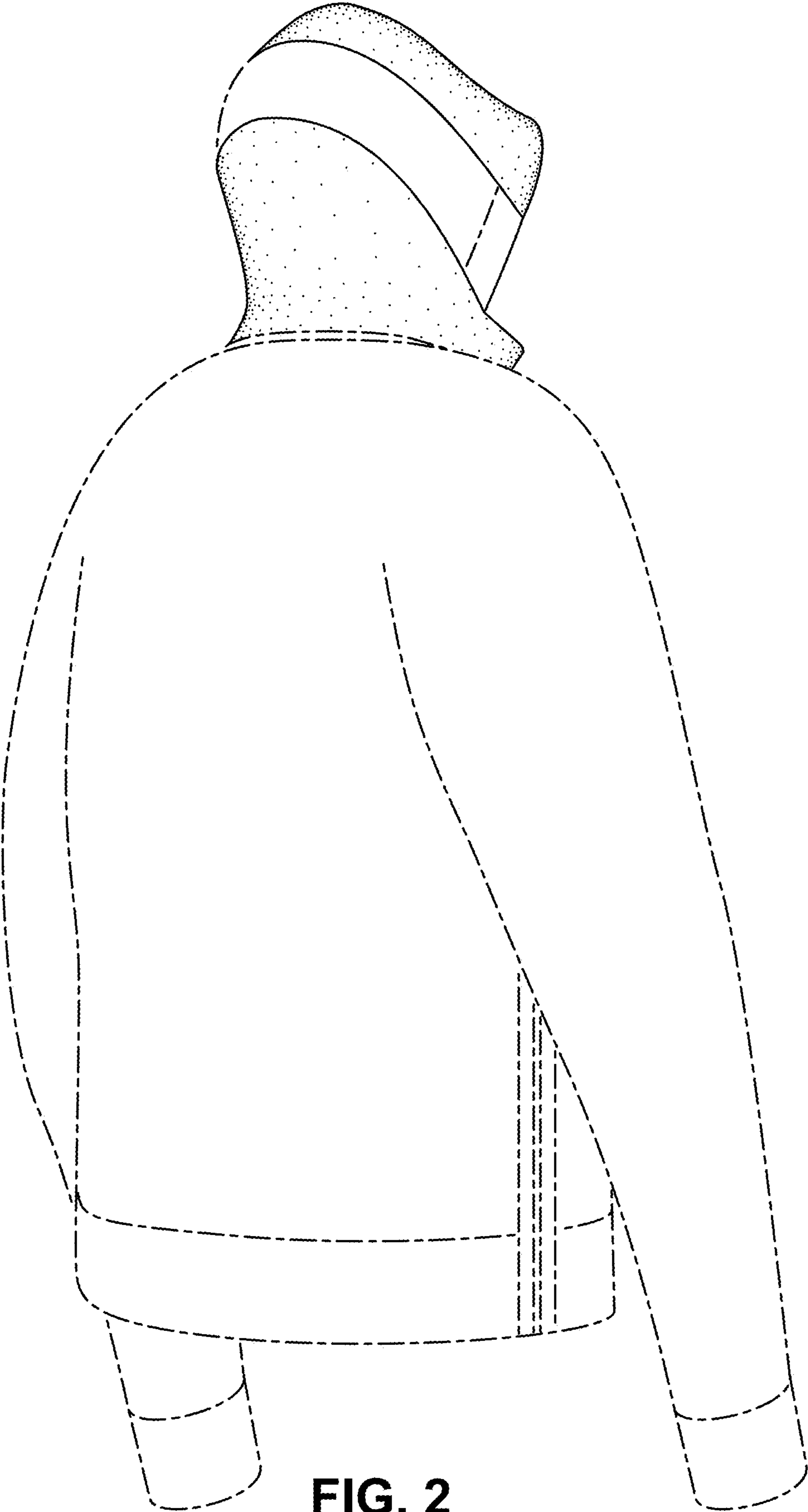

FIG. 2

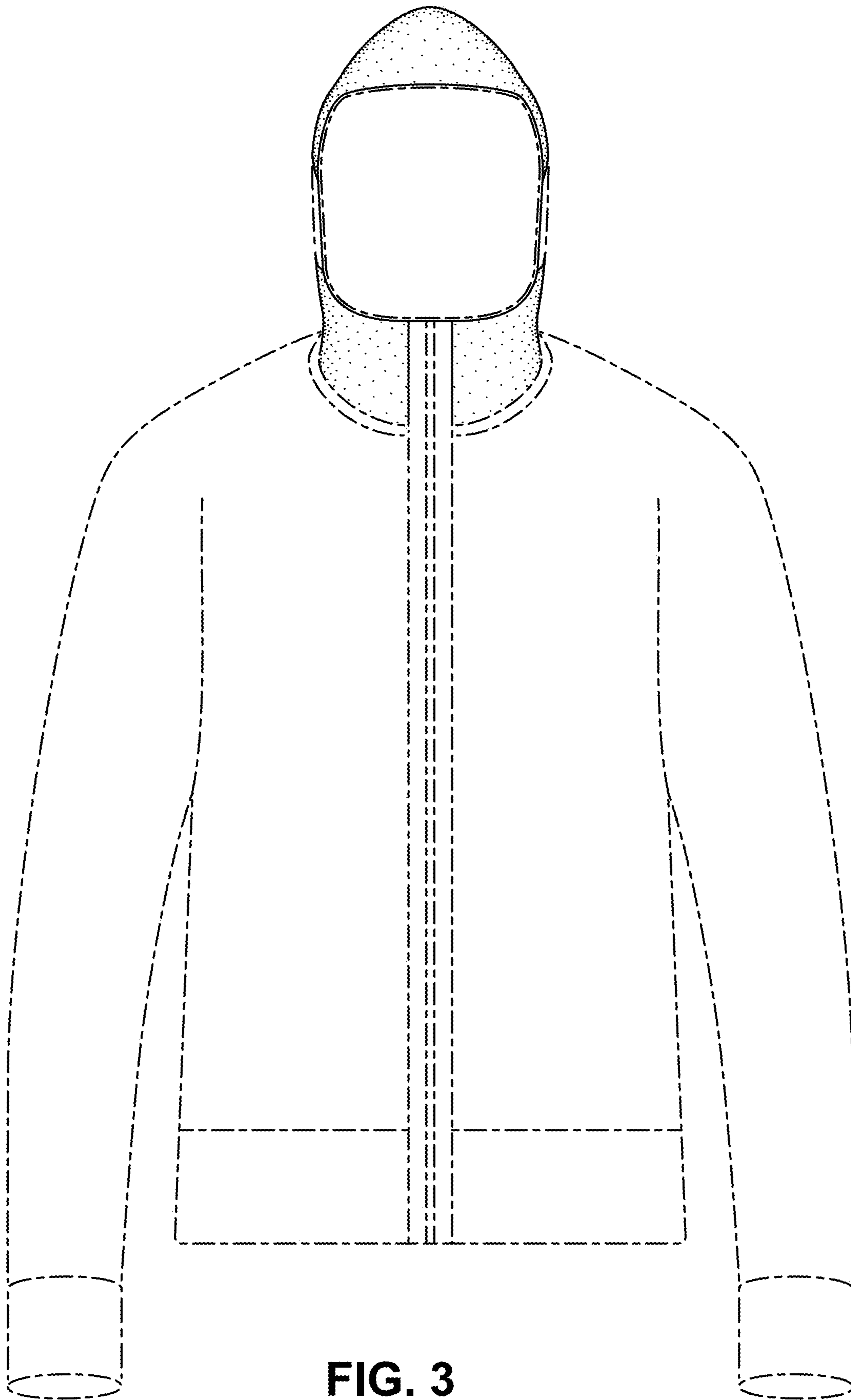

FIG. 3

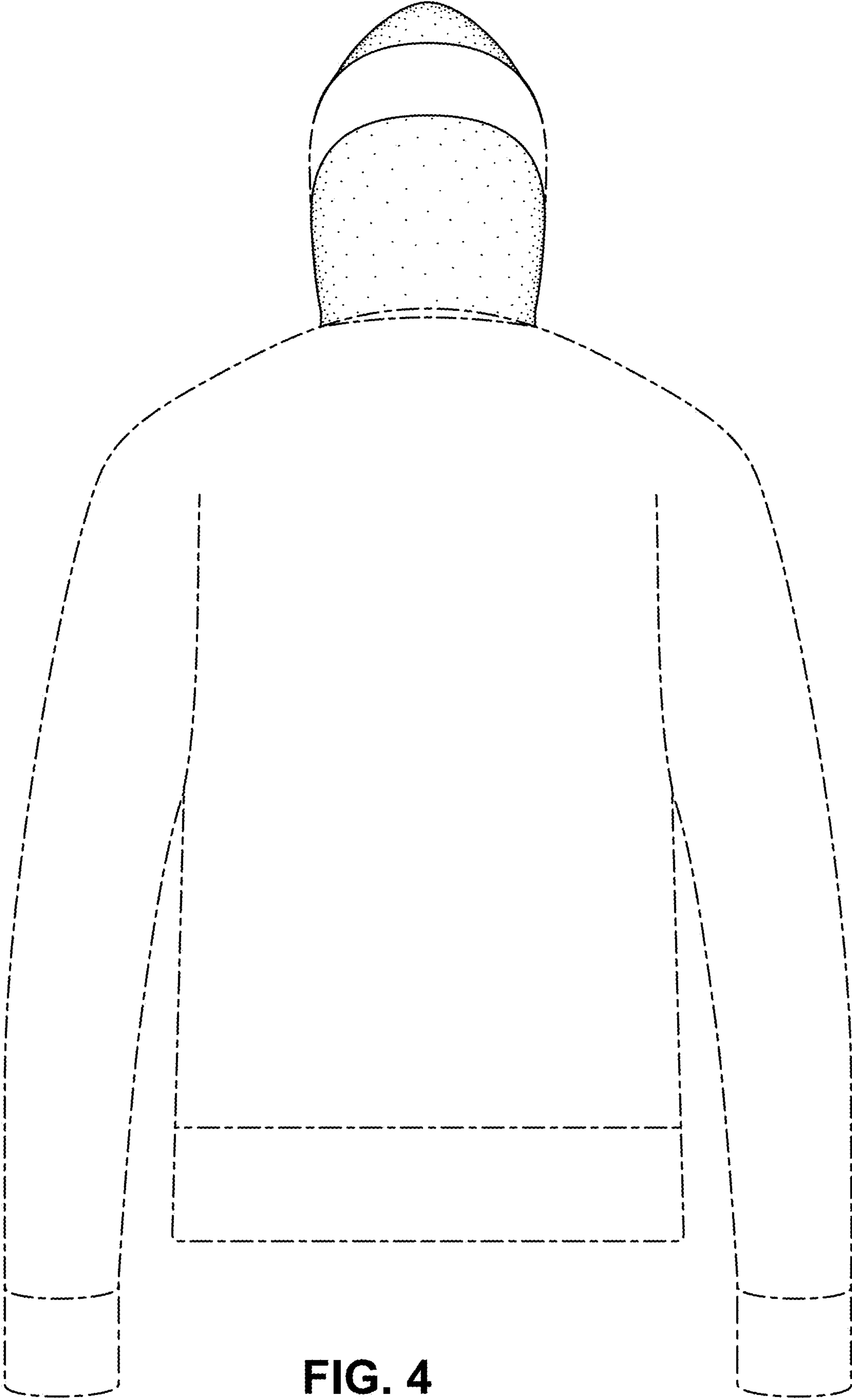

FIG. 4

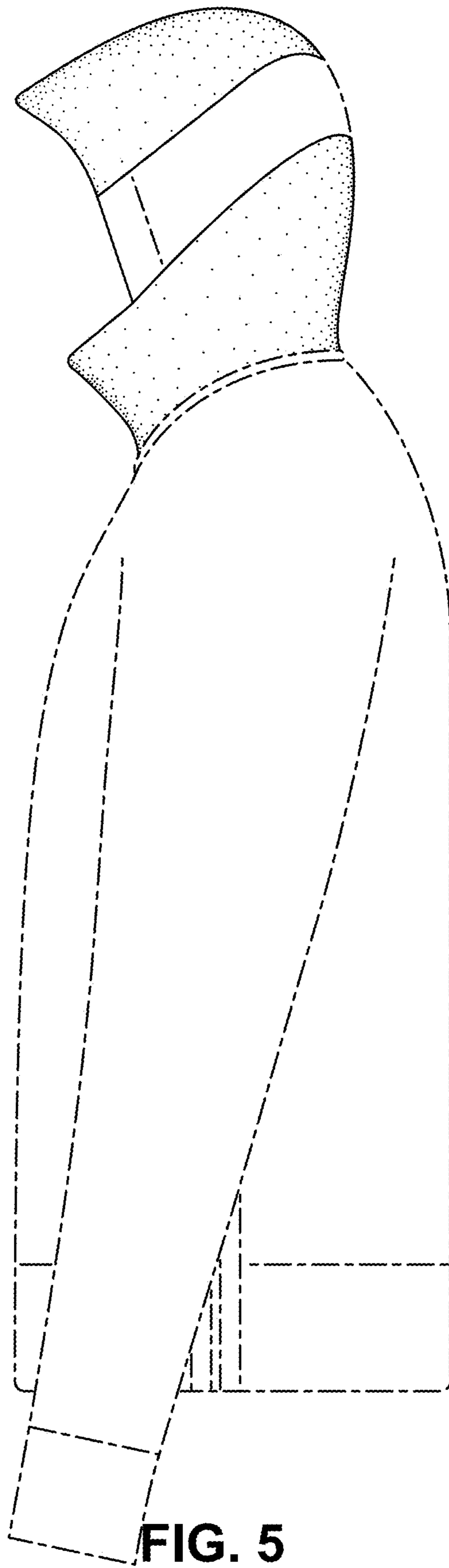

FIG. 5

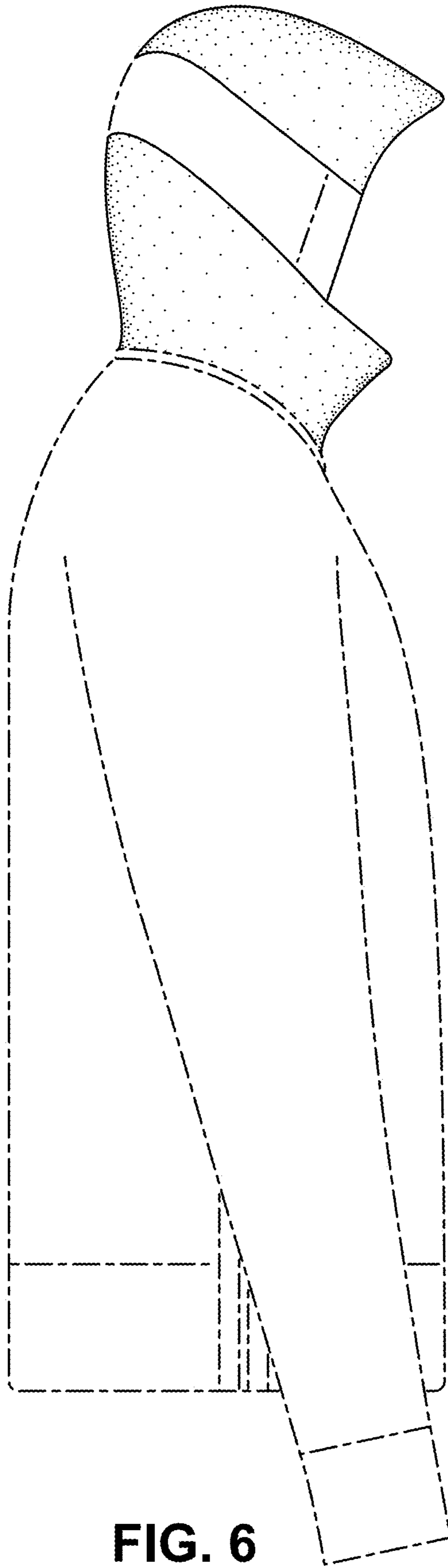

FIG. 6

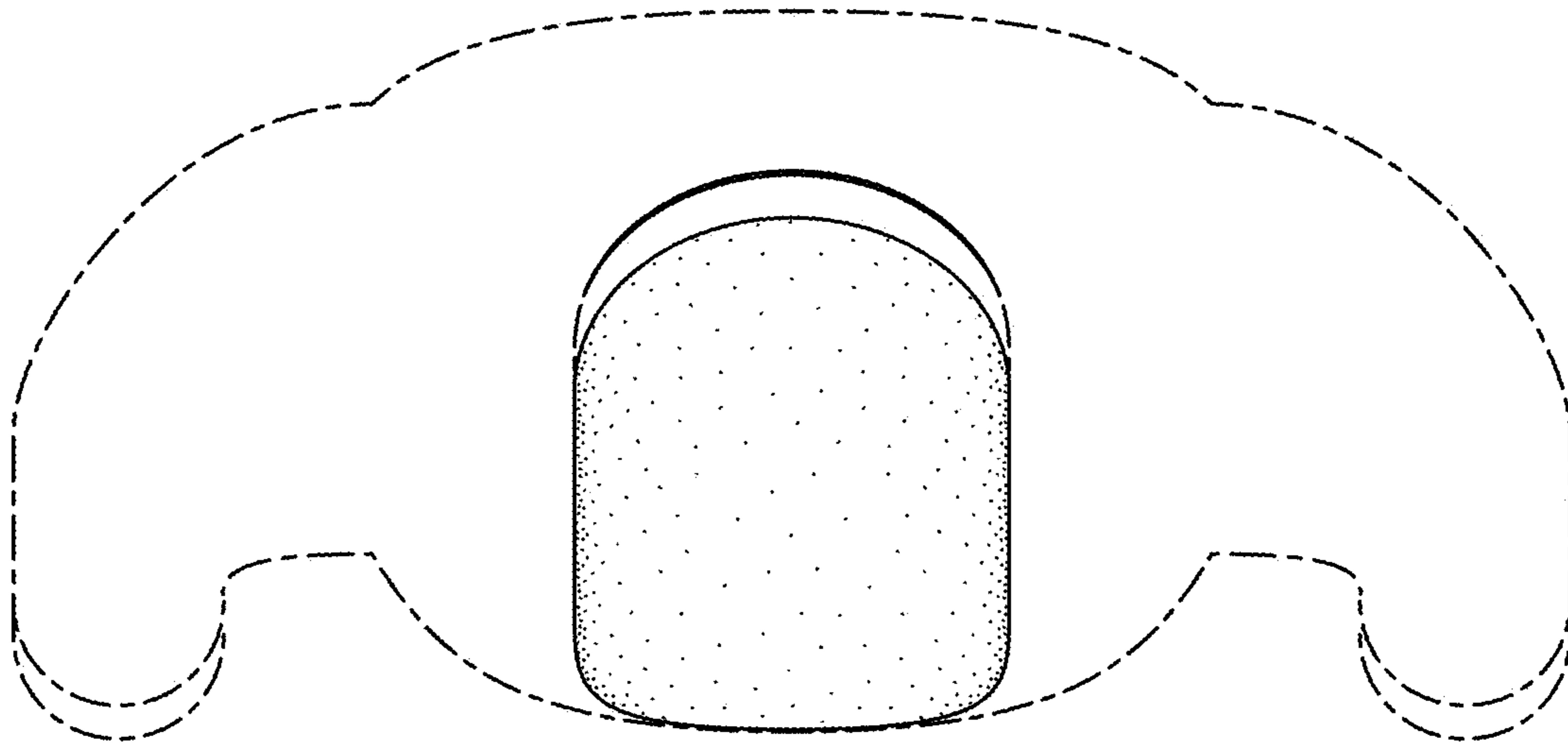

FIG. 7