



US00D884952S

(12) **United States Design Patent**  
**Cao**

(10) **Patent No.:** **US D884,952 S**

(45) **Date of Patent:** **\*\* May 19, 2020**

(54) **LED GARAGE LIGHT**

(71) Applicant: **Jingfeng Cao**, Guangdong Province  
(CN)

(72) Inventor: **Jingfeng Cao**, Guangdong Province  
(CN)

(\*\*) Term: **15 Years**

(21) Appl. No.: **29/723,784**

(22) Filed: **Feb. 10, 2020**

(51) **LOC (12) Cl.** ..... **26-03**

(52) **U.S. Cl.**  
USPC ..... **D26/63; D26/2**

(58) **Field of Classification Search**  
USPC ..... D26/2, 24, 61, 63, 65, 72, 81, 83, 92  
CPC .. F21S 8/036; F21S 8/038; F21S 8/043; F21S  
8/081; F21S 8/083; F21S 8/085; F21S  
8/086; F21S 8/088; F21S 13/10; F21S  
9/03; F21S 9/035; F21S 9/037; F21S  
10/063; F21S 6/003

See application file for complete search history.

(56) **References Cited**

**U.S. PATENT DOCUMENTS**

- 4,528,618 A \* 7/1985 Bitsch ..... F21S 6/003  
362/220
- D357,993 S \* 5/1995 Yuen ..... D26/65
- D578,696 S \* 10/2008 Wang ..... D26/63
- D650,937 S \* 12/2011 Horsley ..... D26/65

- D690,859 S \* 10/2013 Mollaghaffari ..... D26/63
- D745,201 S 12/2015 Lee
- D770,657 S \* 11/2016 Fang ..... D26/63
- D822,868 S \* 7/2018 Liu ..... D26/63
- D861,926 S \* 10/2019 Lin ..... D26/2
- D870,943 S \* 12/2019 Kuang ..... D26/65

\* cited by examiner

*Primary Examiner* — Brian N. Vinson

(74) *Attorney, Agent, or Firm* — ZANIP

(57) **CLAIM**

The ornamental design for an LED garage light, as shown and described.

**DESCRIPTION**

FIG. 1 is a front and top perspective view of an LED garage light, showing my new design;  
 FIG. 2 is a rear and bottom perspective view thereof,  
 FIG. 3 is a front elevational view thereof;  
 FIG. 4 is a rear elevational view thereof;  
 FIG. 5 is a left side elevational view thereof;  
 FIG. 6 is a right side elevational view thereof;  
 FIG. 7 is a top plan view thereof;  
 FIG. 8 is a bottom plan view thereof; and,  
 FIG. 9 is a perspective view thereof, showing the LED garage light in a folded position.  
 The broken lines in the figures illustrate portions of the LED garage light that form no part of the claimed design.

**1 Claim, 9 Drawing Sheets**

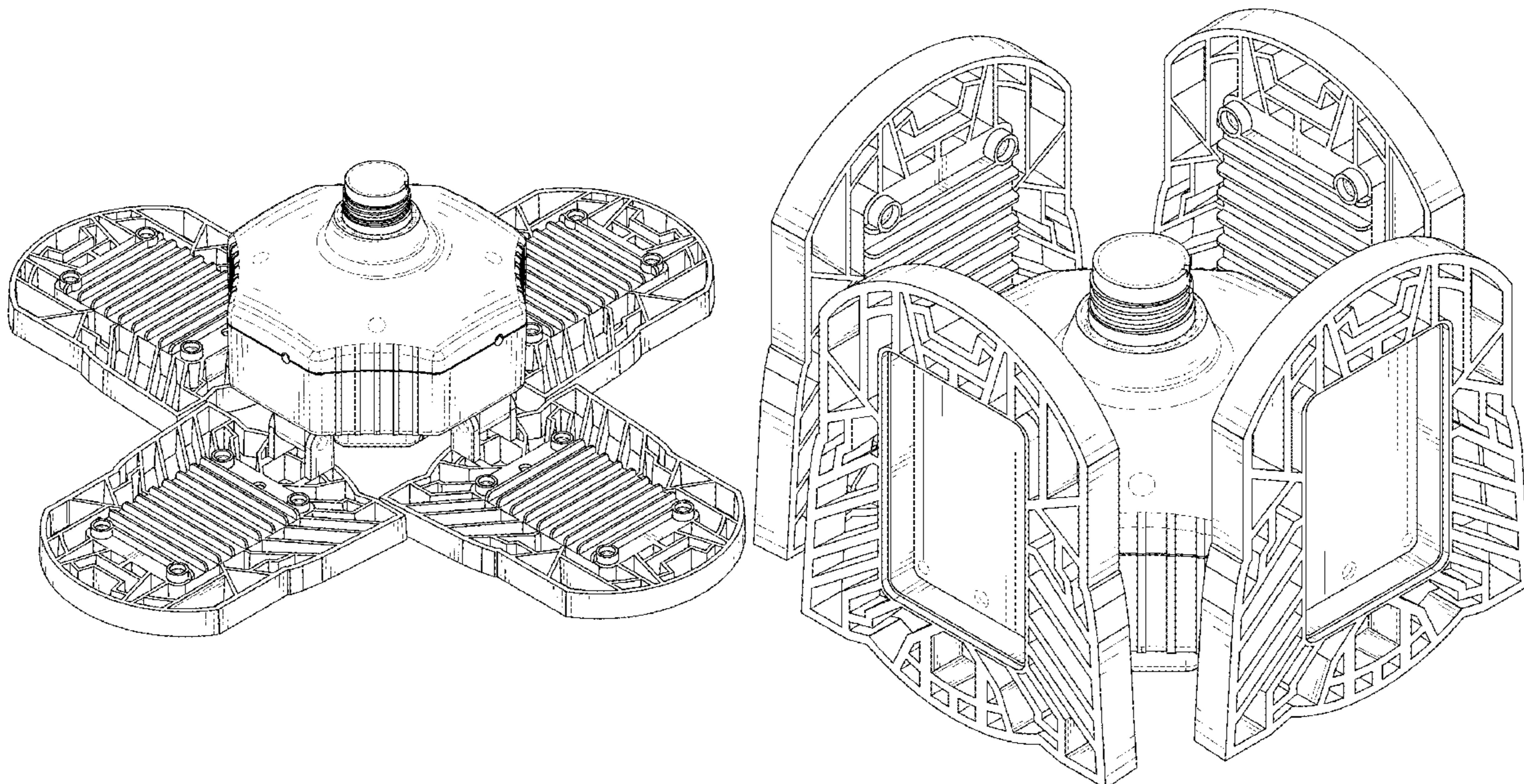

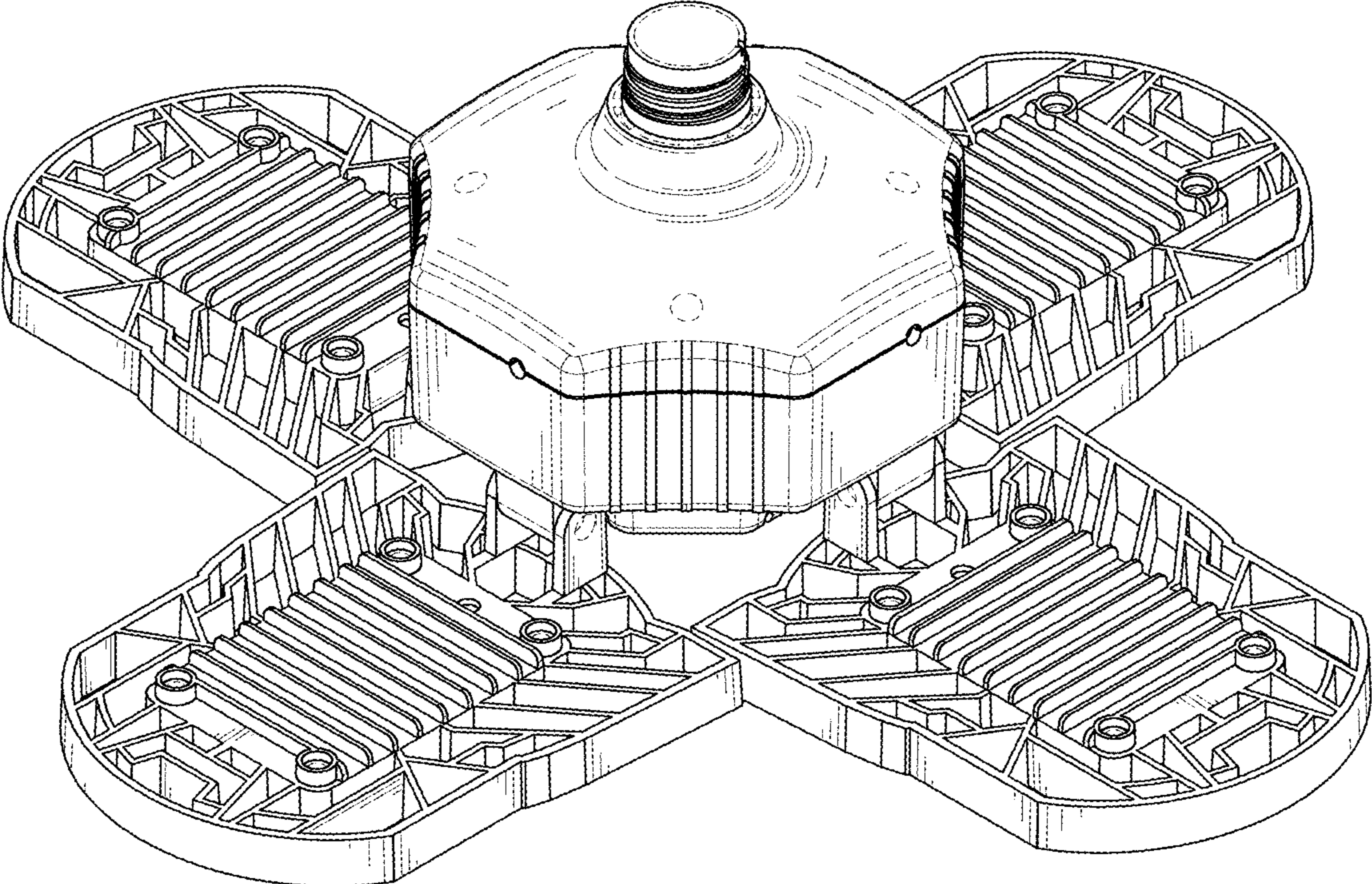

FIG. 1

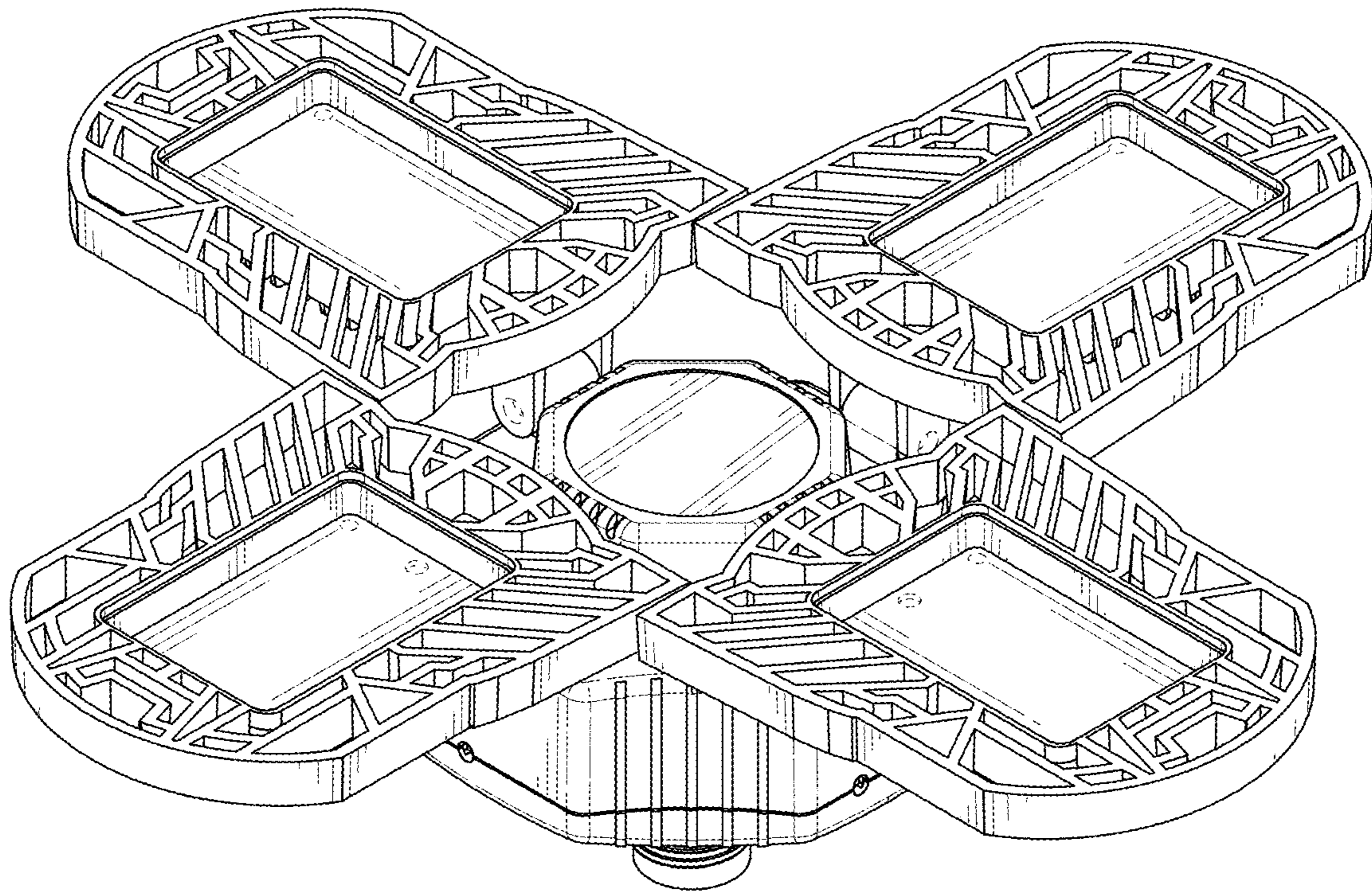

FIG. 2

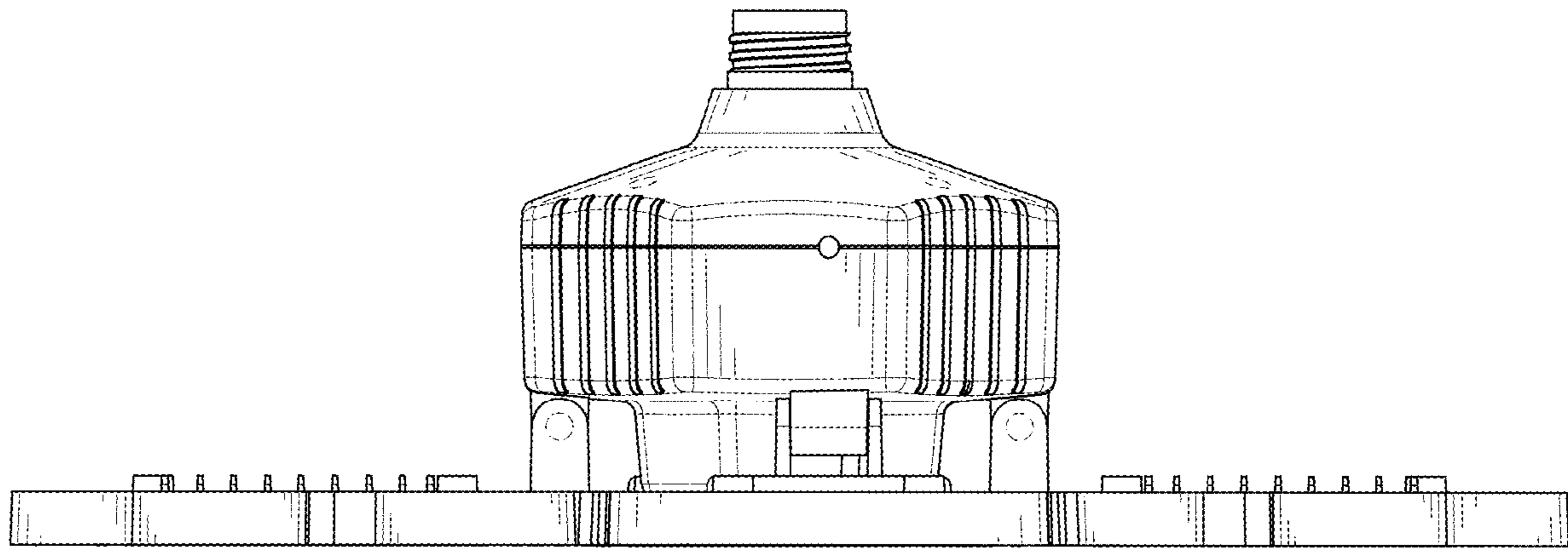

FIG. 3

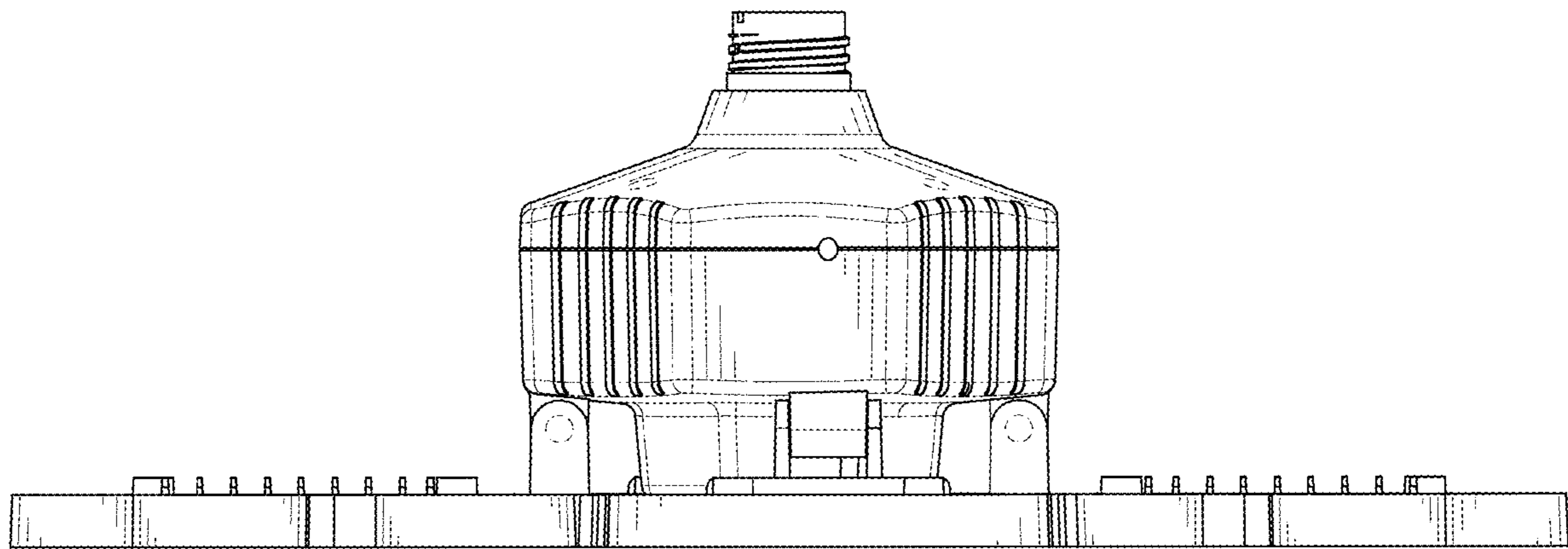

FIG. 4

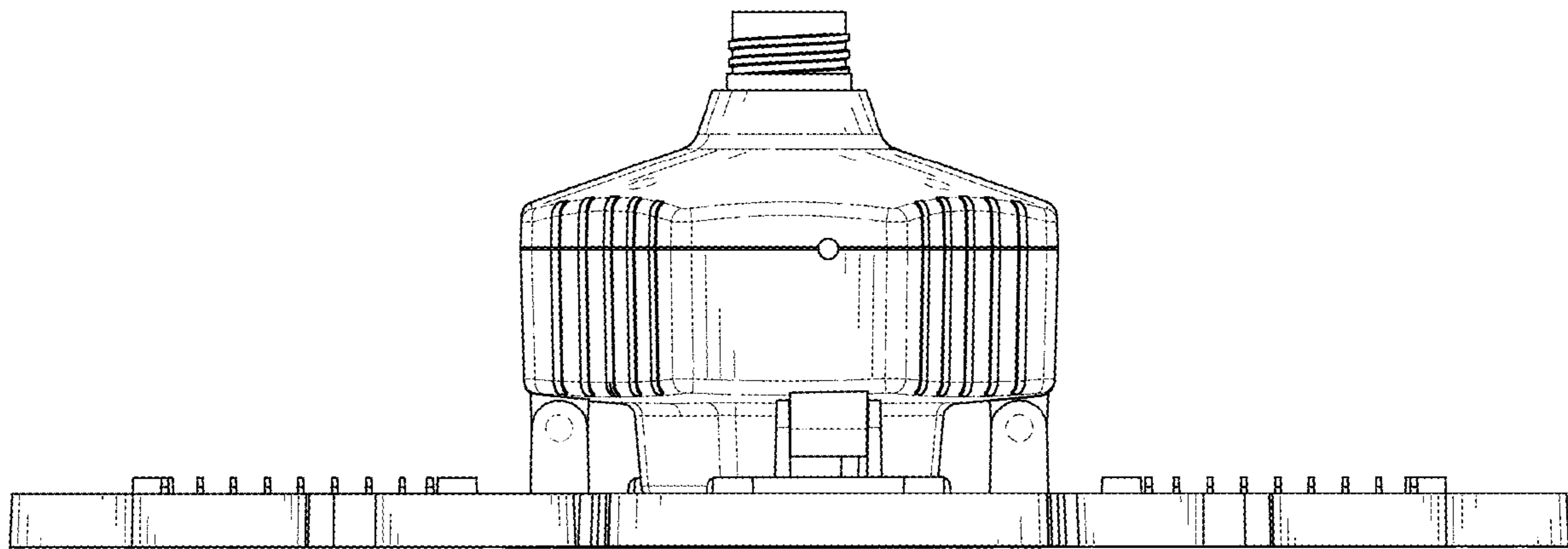

FIG. 5

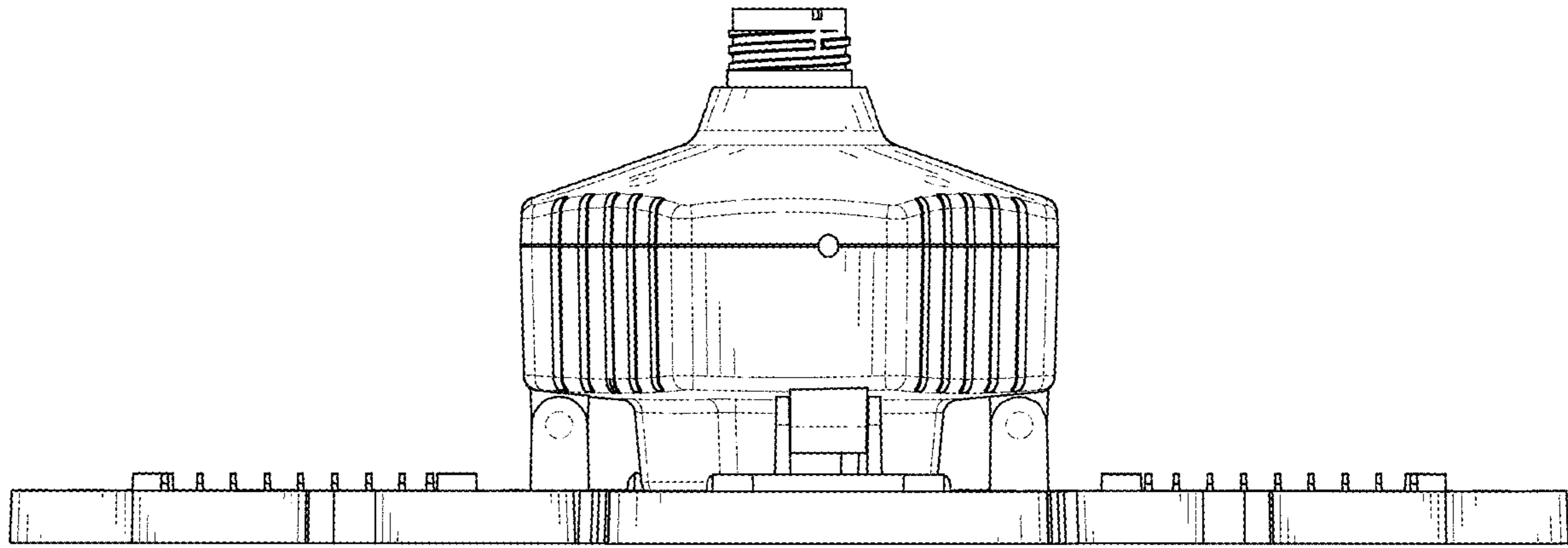

FIG. 6

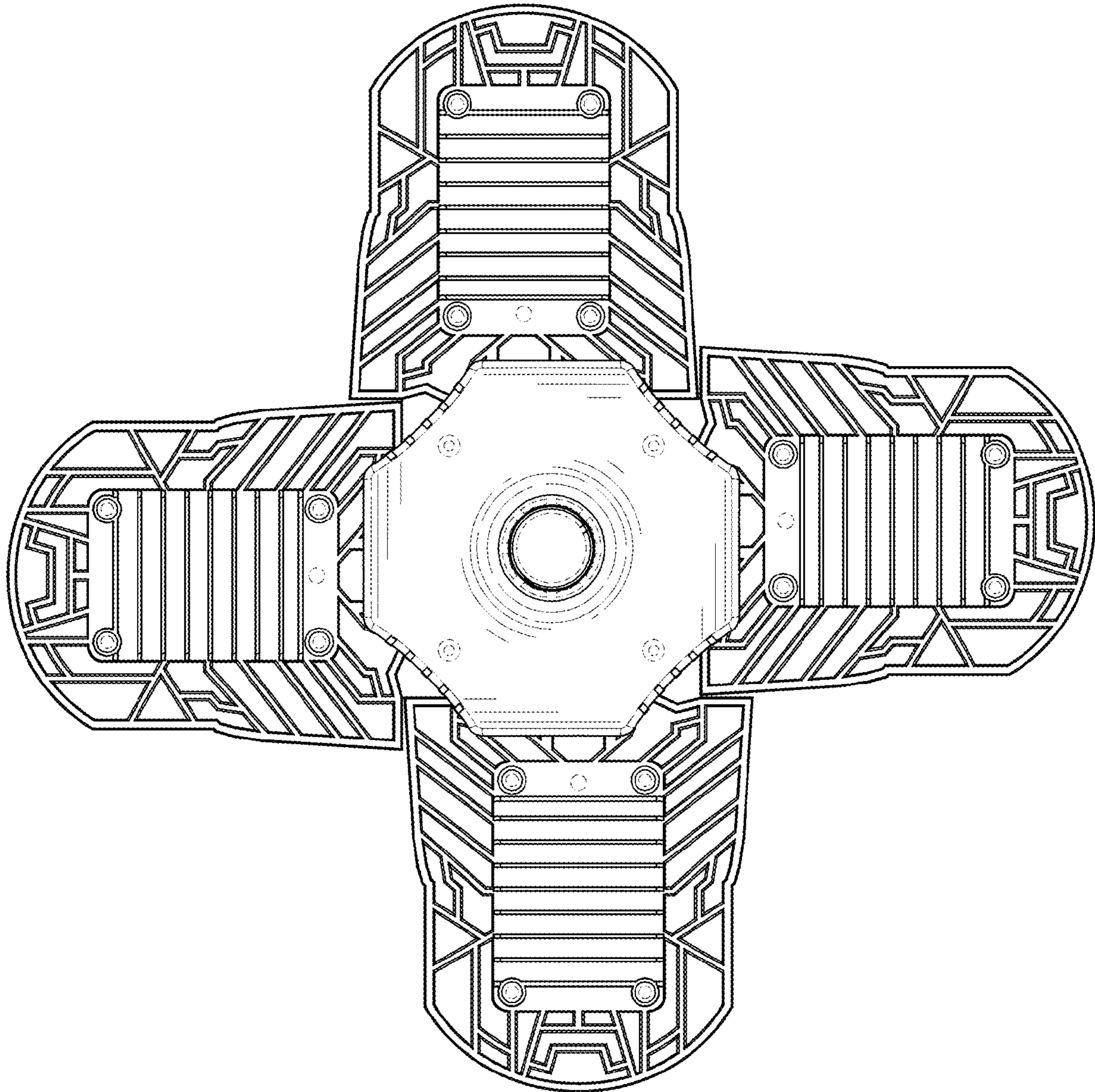

FIG. 7



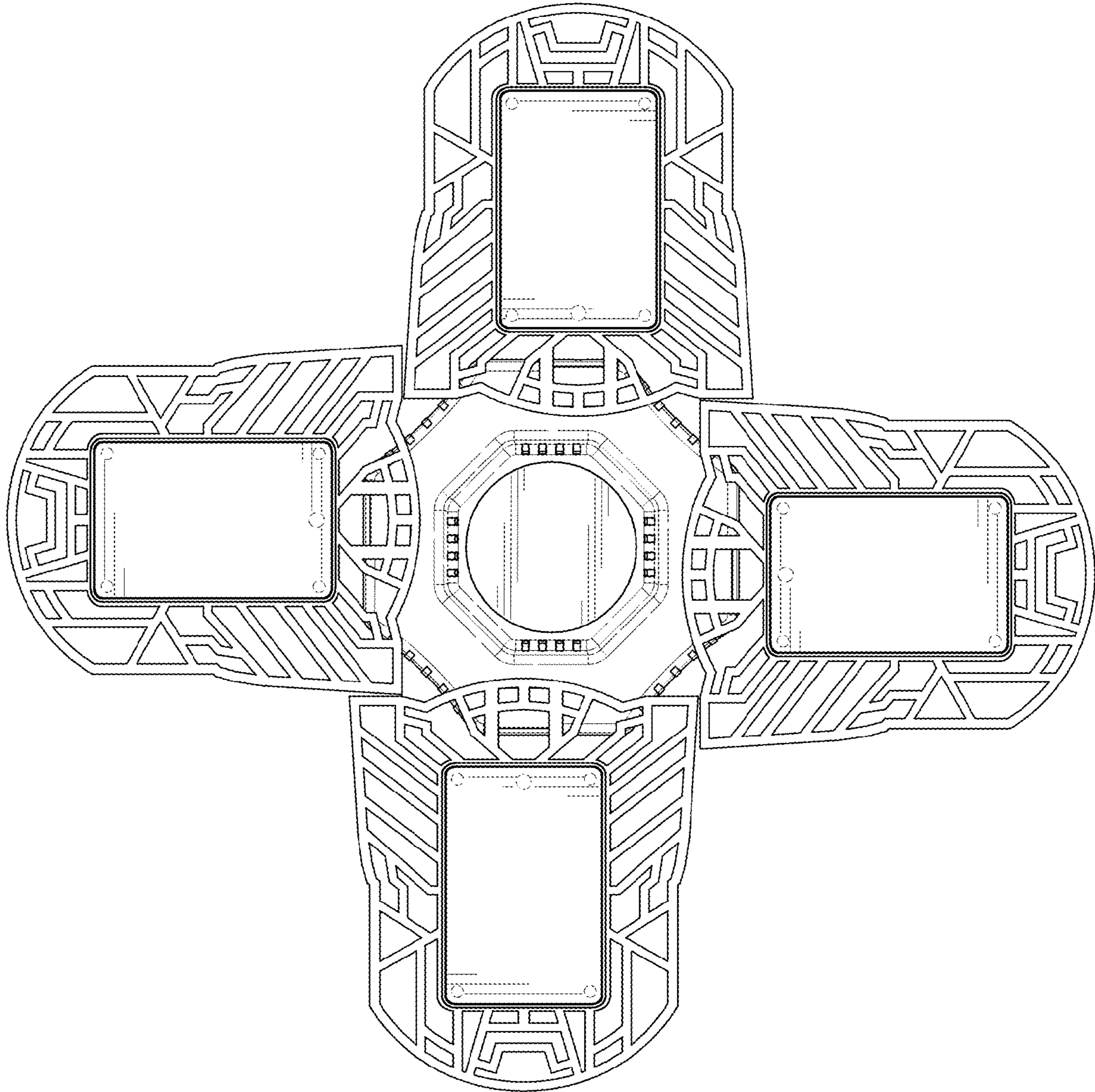

FIG. 8

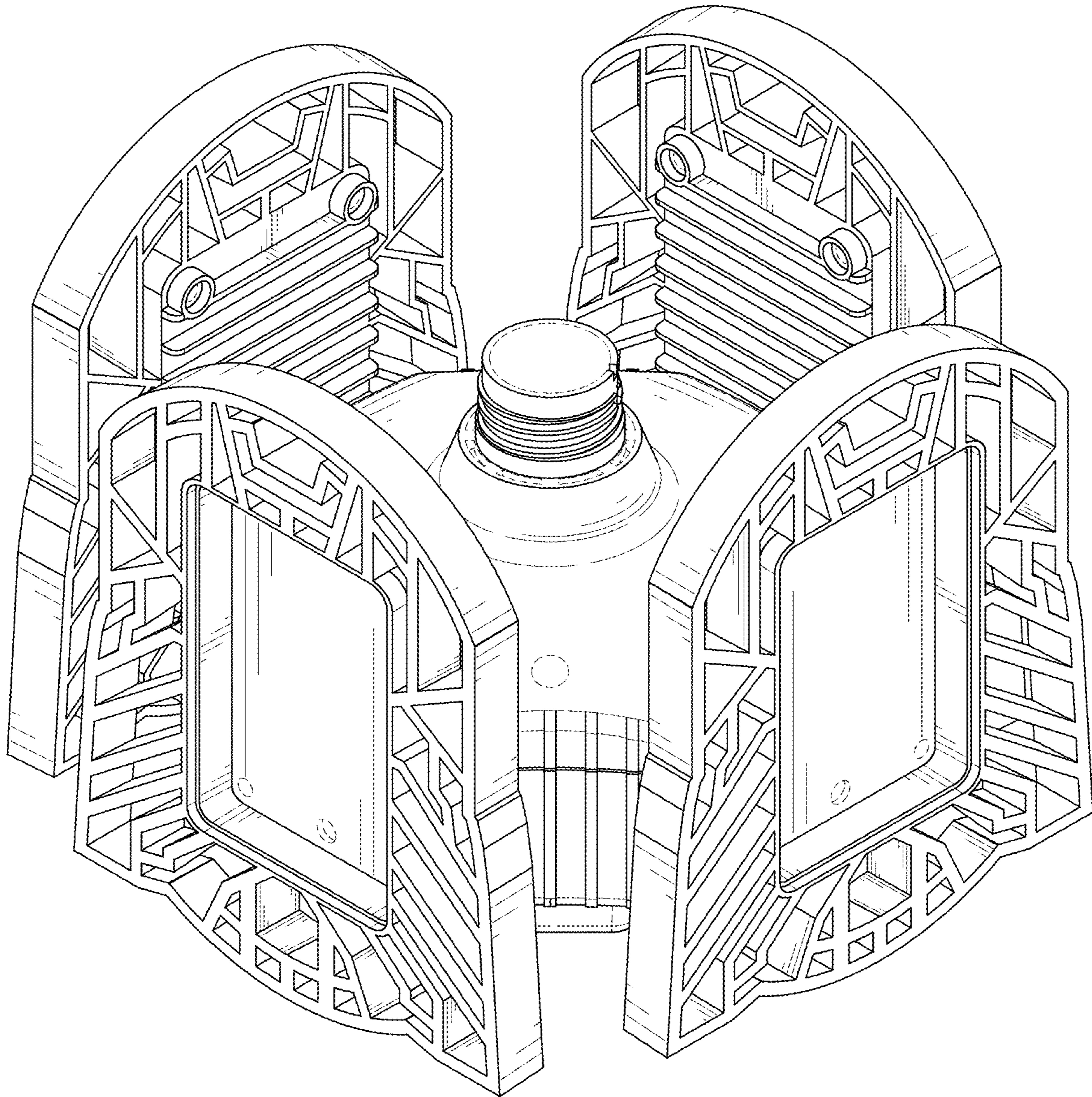

FIG. 9