



US00D884925S

(12) **United States Design Patent** (10) **Patent No.:** **US D884,925 S**  
**Rue** (45) **Date of Patent:** **\*\* May 19, 2020**

(54) **INSULATED WOOD REINFORCED STRUCTURAL BUILDING PANEL**

(71) Applicant: **Richard L Rue**, Little Elm, TX (US)

(72) Inventor: **Richard L Rue**, Little Elm, TX (US)

(\*\*) Term: **15 Years**

(21) Appl. No.: **29/694,553**

(22) Filed: **Jun. 11, 2019**

(51) **LOC (12) Cl.** ..... **25-01**

(52) **U.S. Cl.**

USPC ..... **D25/113; D25/138**

(58) **Field of Classification Search**

USPC ..... D25/102, 103, 112, 113, 114, 115, 118, D25/138, 139, 140, 144; 428/34.2; 52/309.4, 309.8, 426, 582, 590.1, 293.1

CPC ..... E04C 2/38; E04C 2/44; E04C 3/29; E04C 2/384; E04C 2/388; E04C 3/07; E04C 1/00; E04C 2/32; B32B 5/20; B32B 27/40; E04B 1/61; E04B 1/62; E04B 1/14

See application file for complete search history.

(56) **References Cited**

**U.S. PATENT DOCUMENTS**

2,068,798	A *	1/1937	Gray	.....	E04C 1/42 52/308
3,449,879	A *	6/1969	Bloom	.....	E04B 1/04 52/309.5
4,787,189	A *	11/1988	Haug	.....	E04B 2/18 52/415
5,570,552	A *	11/1996	Nehring	.....	E02D 27/02 249/91
5,598,675	A *	2/1997	Pruss	.....	E04B 2/8617 52/309.4
5,943,775	A *	8/1999	Lanahan	.....	B26D 1/553 264/142
6,167,624	B1 *	1/2001	Lanahan	.....	B26D 1/553 264/142

(Continued)

**OTHER PUBLICATIONS**

EnergyWise Panel Systems—Energy Saving Panels for Construction (on-line), dated Nov. 27, 2018. Retrieved from Internet Sep. 6, 2019 , URL: <http://web.archive.org/web/20181127095656/https://www.ewbsi.com/> (1 page) (Year: 2018).\*

(Continued)

*Primary Examiner* — Kevin K Rudzinski

*Assistant Examiner* — Kimberly Barnes

(74) *Attorney, Agent, or Firm* — Mark W Handley; Handley Law Firm, PLLC

(57) **CLAIM**

The ornamental design for an insulated wood reinforced structural building panel, as shown and described.

**DESCRIPTION**

FIG. 1 is a perspective view of an insulated wood reinforced structural building panel embodying my design, and depicting the environment in which the panel is used in an exploded view;

FIG. 2 is a front view of the insulated wood reinforced structural building panel;

FIG. 3 is a rear view of the insulated wood reinforced structural building panel;

FIG. 4 is a left side view of the insulated wood reinforced structural building panel;

FIG. 5 is a right side view of the insulated wood reinforced structural building panel;

FIG. 6 is a top view of the insulated wood reinforced structural building panel; and,

FIG. 7 is a bottom view of the insulated wood reinforced structural building panel.

The broken lines in FIG. 1 depict environmental subject matter that forms no part of the claimed design.

**1 Claim, 5 Drawing Sheets**

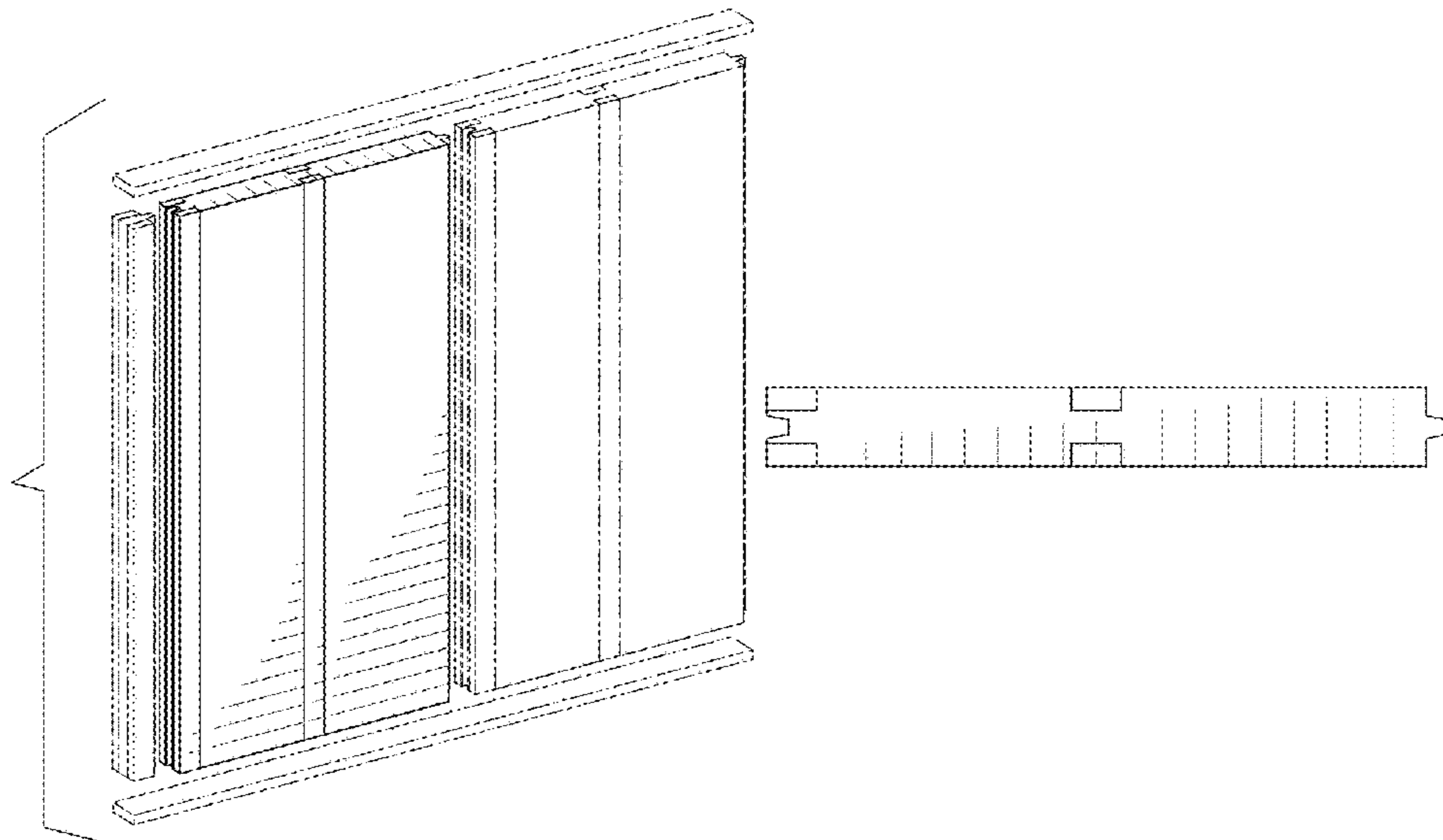

(56)

**References Cited**

U.S. PATENT DOCUMENTS

6,584,740	B2 *	7/2003	Record	.....	E04B 1/14 52/270
6,647,686	B2 *	11/2003	Dunn	.....	E04B 2/8641 52/309.17
7,543,419	B2	6/2009	Rue		
D662,225	S *	6/2012	Amidon	.....	D25/113
8,316,612	B2 *	11/2012	Dickens	.....	E04B 1/90 52/220.2
8,707,631	B2 *	4/2014	Scouten	.....	E04B 1/34321 52/220.2
8,756,889	B2 *	6/2014	LeBlang	.....	E04B 1/80 52/252
9,309,671	B2 *	4/2016	Van Sloun	.....	E04C 2/296
10,011,989	B2 *	7/2018	Pence	.....	E04C 2/34
10,344,479	B2 *	7/2019	Nugent		
D861,194	S *	9/2019	Morrow	.....	D25/138
2005/0204697	A1	9/2005	Rue		
2011/0047912	A1 *	3/2011	Armijo	.....	E04B 1/12 52/309.4

2013/0042556	A1 *	2/2013	Armijo	.....	E04B 1/14 52/309.4
2013/0149477	A1 *	6/2013	Minelli	.....	B32B 1/02 428/34.2
2015/0218808	A1 *	8/2015	Bates	.....	E04C 2/205 52/274
2018/0073797	A1 *	3/2018	Taqi	.....	F25D 23/065
2019/0145101	A1 *	5/2019	Costanza	.....	E04C 3/29 52/309.8
2019/0145699	A1 *	5/2019	Mellits	.....	E05B 63/00 312/406
2019/0242129	A1 *	8/2019	LeBlang	.....	E04B 1/40

OTHER PUBLICATIONS

Thermasteel RevPanel System (on-line), dated Oct. 6, 2016. Retrieved from Internet Sep. 9, 2019, URL: <http://web.archive.org/web/20161006192156/https://www.thermasteelinc.com/content/revpanel-system> (6 pages) (Year: 2016).\*

\* cited by examiner

FIG. 1

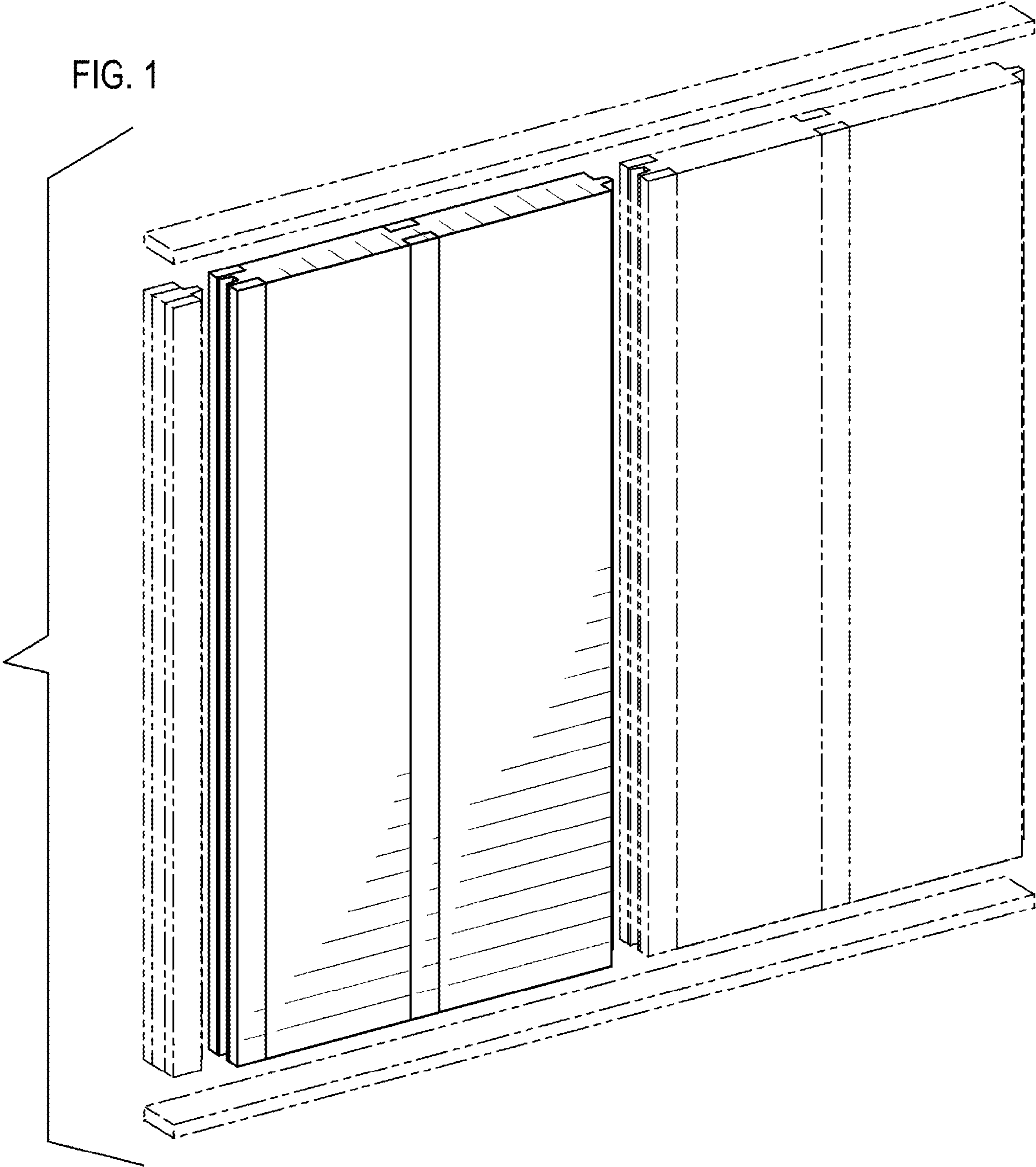

FIG. 2

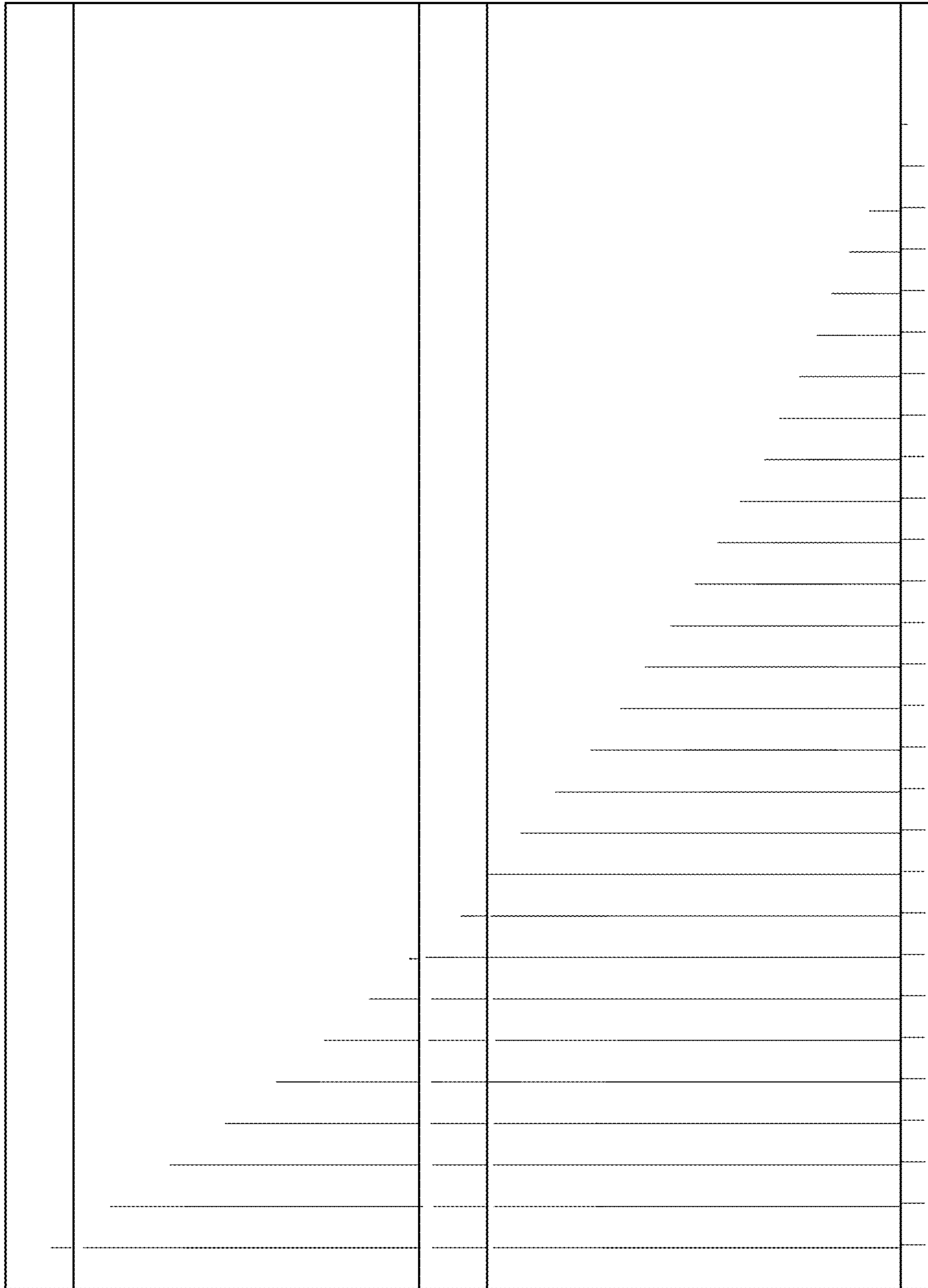

FIG. 3

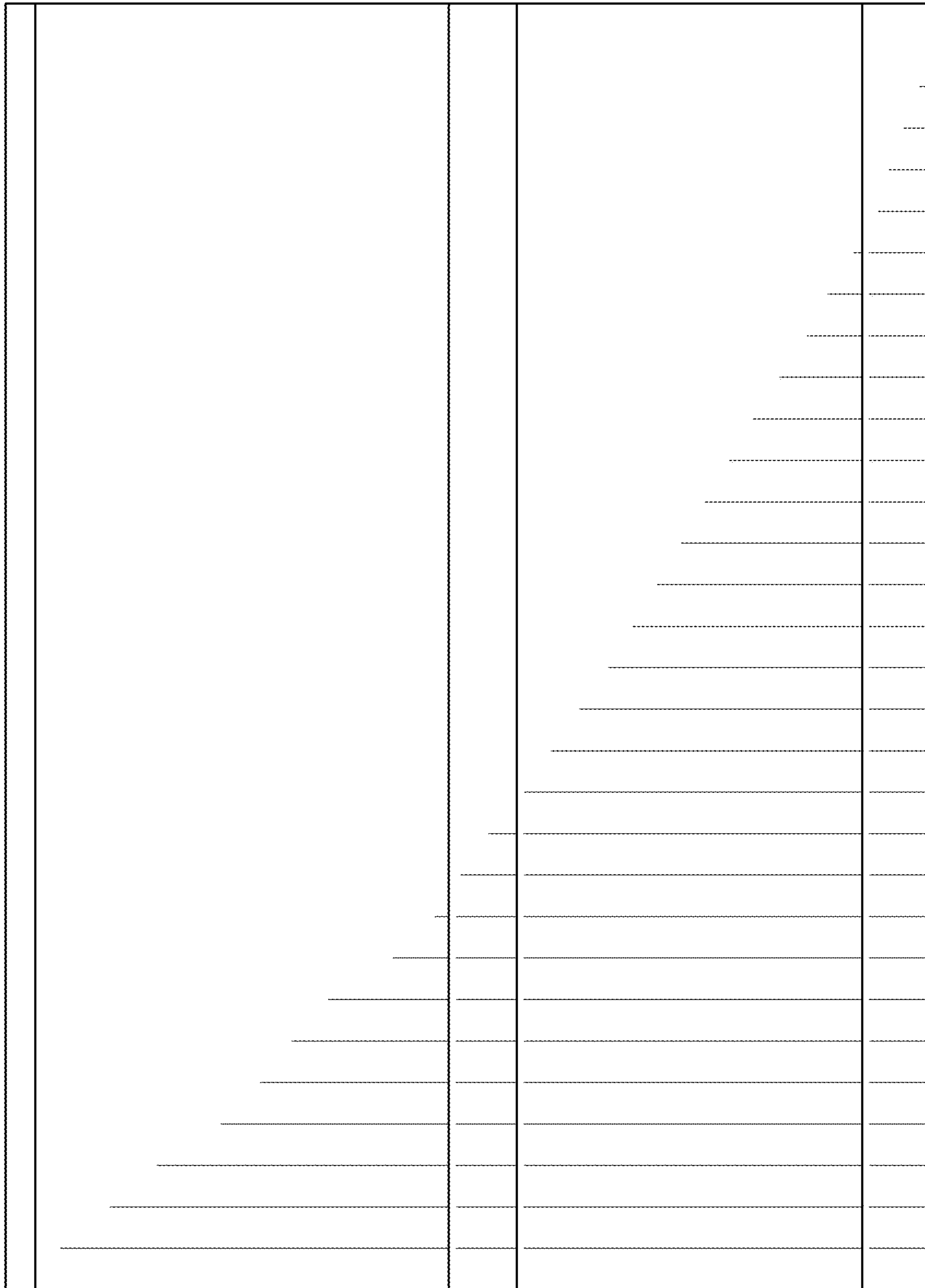



FIG. 4

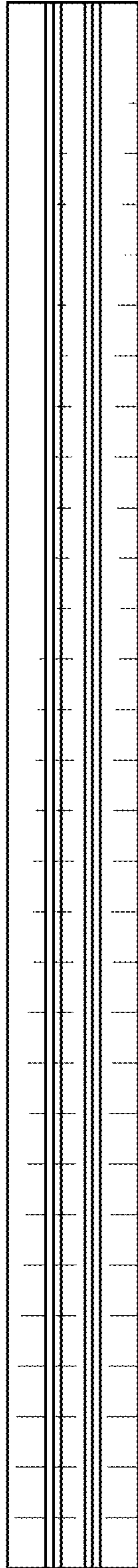

FIG. 5

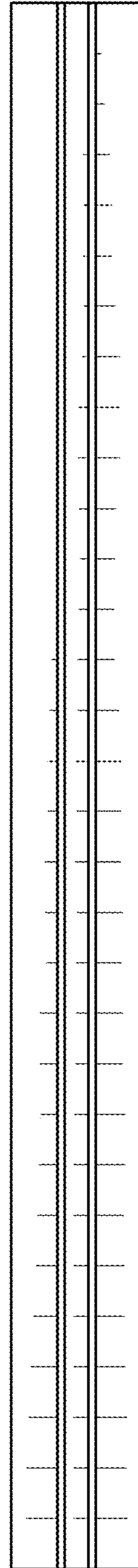

FIG. 6

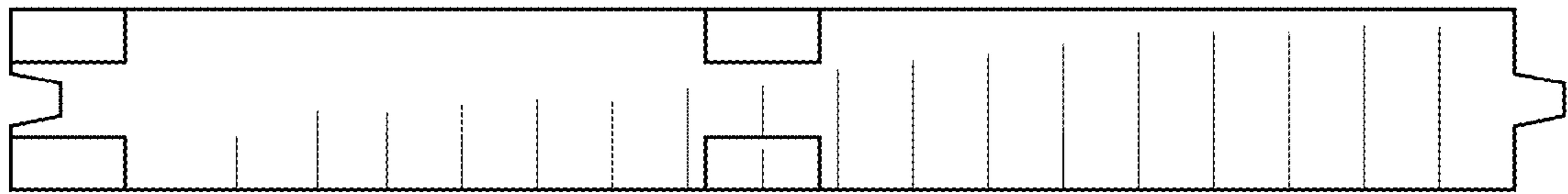

FIG. 7

