



US00D884924S

(12) **United States Design Patent**
Lenci

(10) **Patent No.:** **US D884,924 S**

(45) **Date of Patent:** **** May 19, 2020**

- (54) **LADDER BUFFER**
- (71) Applicant: **Marc S. Lenci**, Mt. Vernon, NY (US)
- (72) Inventor: **Marc S. Lenci**, Mt. Vernon, NY (US)
- (**) Term: **15 Years**
- (21) Appl. No.: **29/634,461**
- (22) Filed: **Jan. 22, 2018**
- (51) **LOC (12) Cl.** **25-04**
- (52) **U.S. Cl.**
USPC **D25/68**
- (58) **Field of Classification Search**
USPC D25/35, 38.1, 39, 41.1, 42-45, 48.8,
D25/61-68, 38; 182/107; 108/51.3,
108/53.1; 206/600
CPC ... E06C 7/423; E06C 7/48; E06C 7/44; E06C
7/482; E06C 7/46; E06C 7/10; E06C
1/34; B65D 2519/00273; B65D
2519/00104; B65D 2519/00139
See application file for complete search history.

- 6,513,625 B1 * 2/2003 Gaskins E04D 15/00
182/107
- D810,960 S * 2/2018 Umlor D25/68
- D812,778 S * 3/2018 Brown D25/68
- 10,202,805 B2 * 2/2019 Surdo E06C 7/488
- D872,879 S * 1/2020 Lenci D25/68

* cited by examiner

Primary Examiner — Gino Colan

(74) *Attorney, Agent, or Firm* — Lackenbach Siegel, LLP;
Andrew F. Young, Esq.

(57) **CLAIM**

The ornamental design for a ladder buffer, as shown and described.

DESCRIPTION

FIG. 1 is a front top perspective view of a ladder buffer showing my new design.
 FIG. 2 is a bottom rear perspective view thereof.
 FIG. 3 is a front elevation view thereof.
 FIG. 4 is a rear elevation view thereof.
 FIG. 5 is a right side elevation view thereof.
 FIG. 6 is a left side elevation view thereof.
 FIG. 7 is a top plan view thereof.
 FIG. 8 is rear plan view thereof; and,
 FIG. 9 is an illustrative front bottom perspective in a use configuration with a ladder.

The broken lines shown in the figures are for the purpose of illustrating environment and form no part of the claimed design.

1 Claim, 7 Drawing Sheets

(56) **References Cited**

U.S. PATENT DOCUMENTS

- D192,218 S * 2/1962 Forsman D6/349
- 4,726,446 A * 2/1988 Perbix E06C 7/48
182/107
- D401,354 S * 11/1998 LaValle D25/68

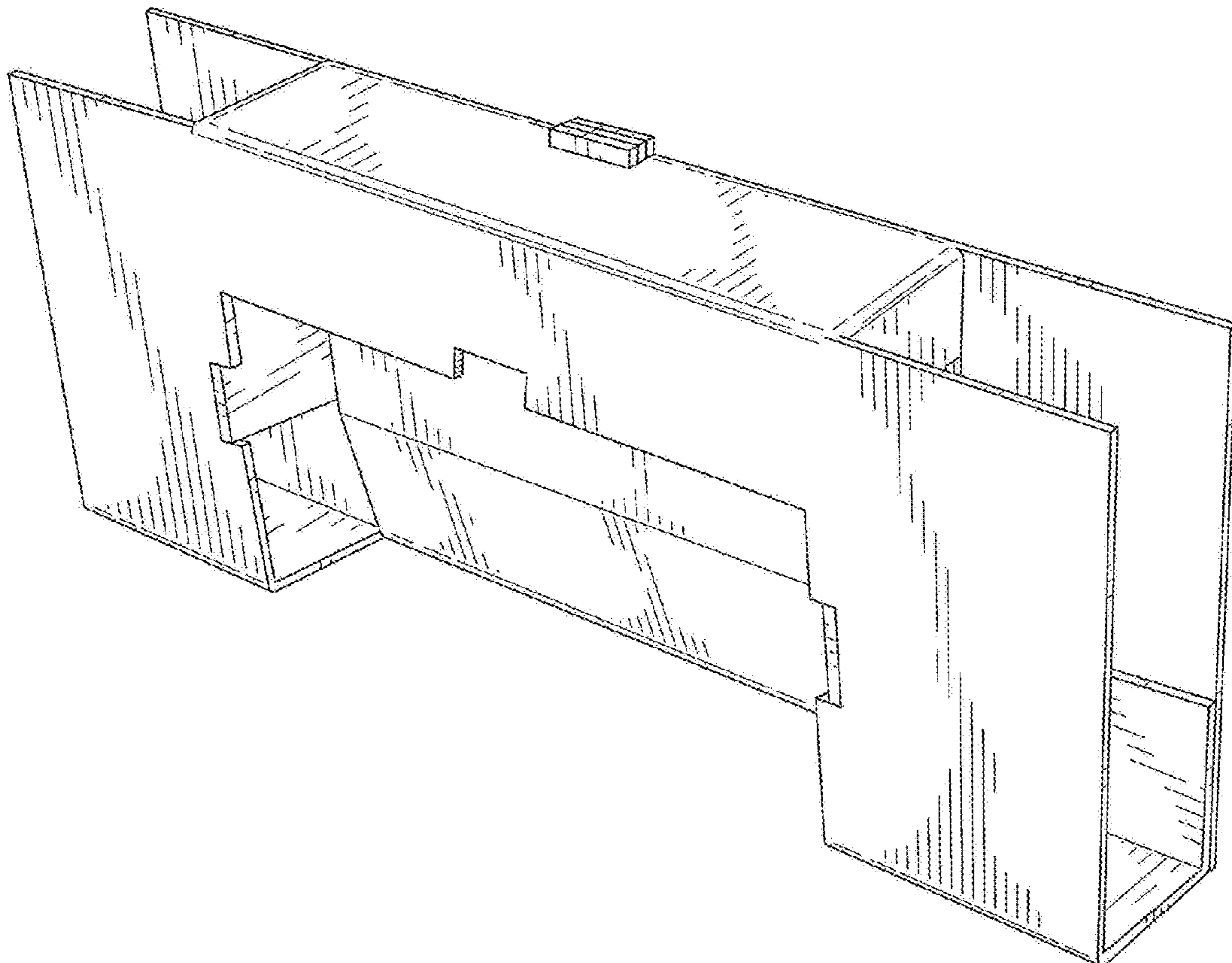

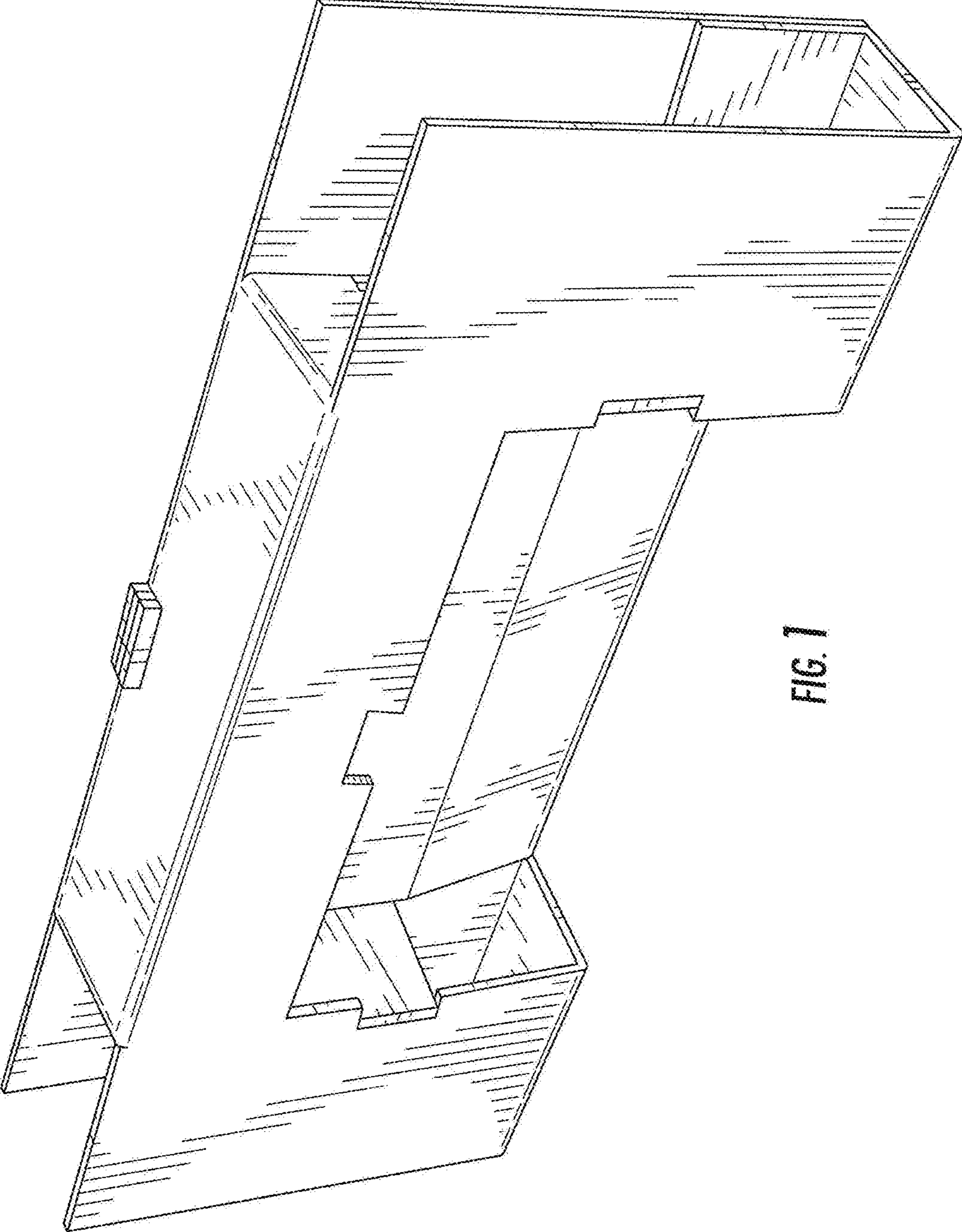

FIG. 1

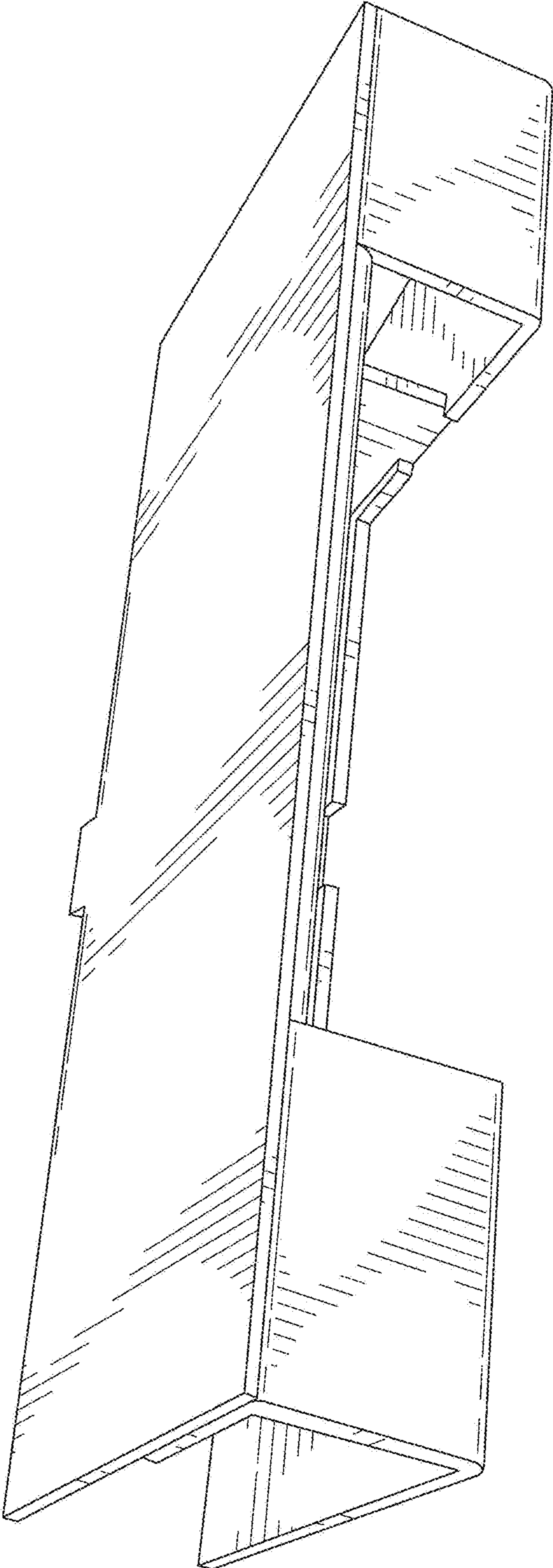

FIG. 2

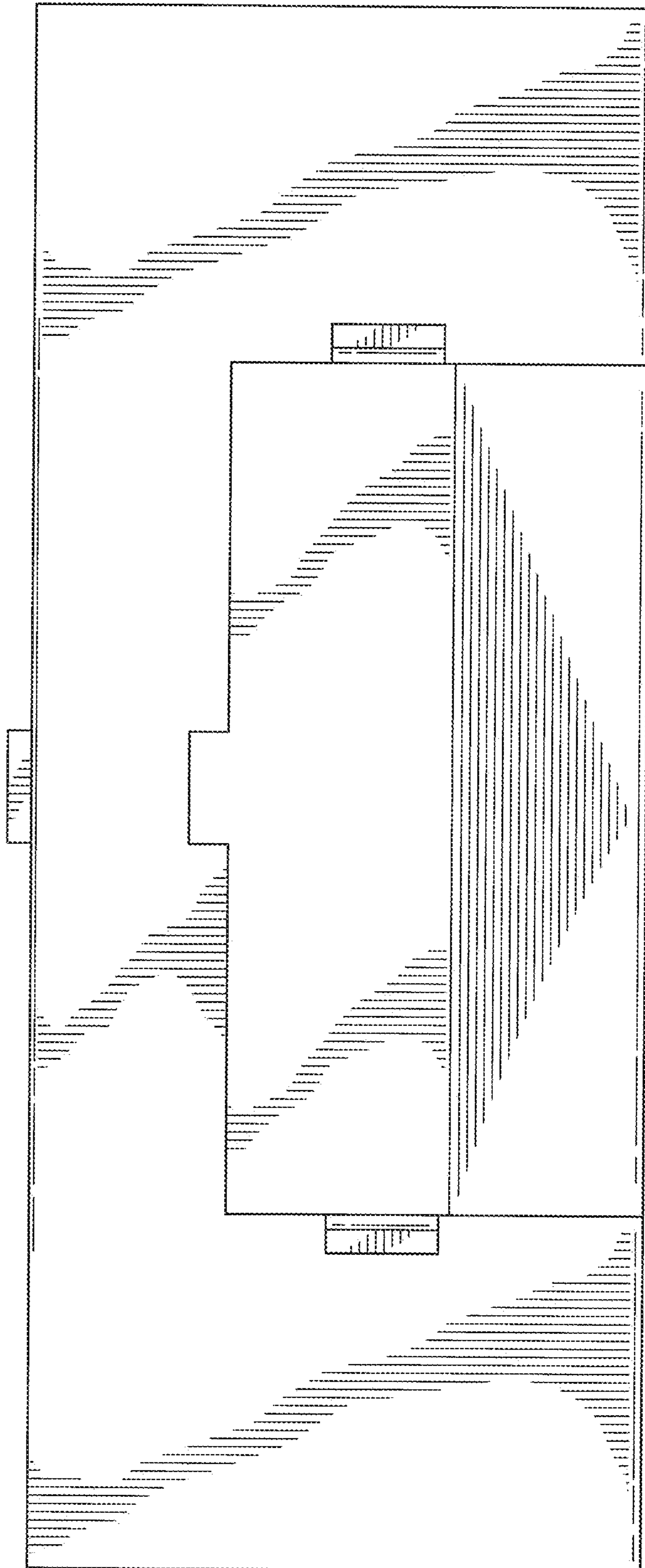

FIG. 3

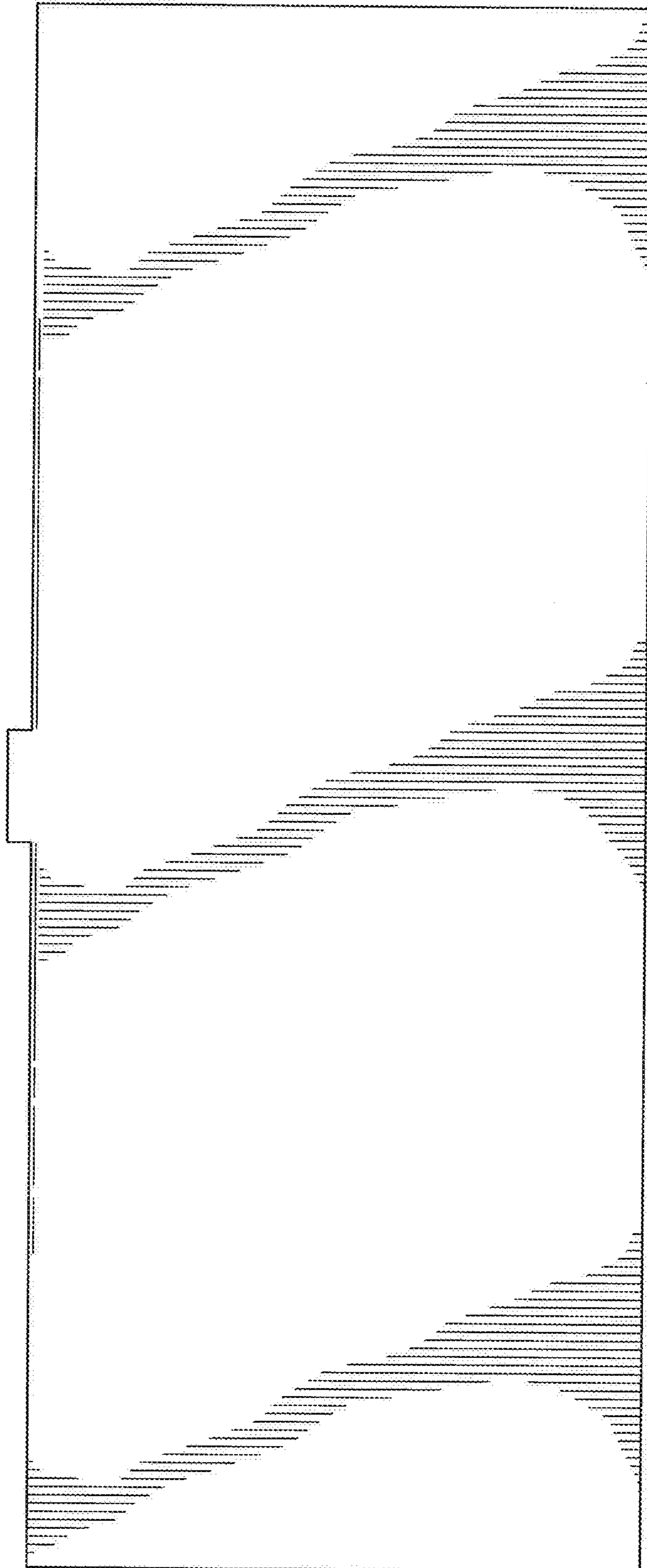

FIG. 4

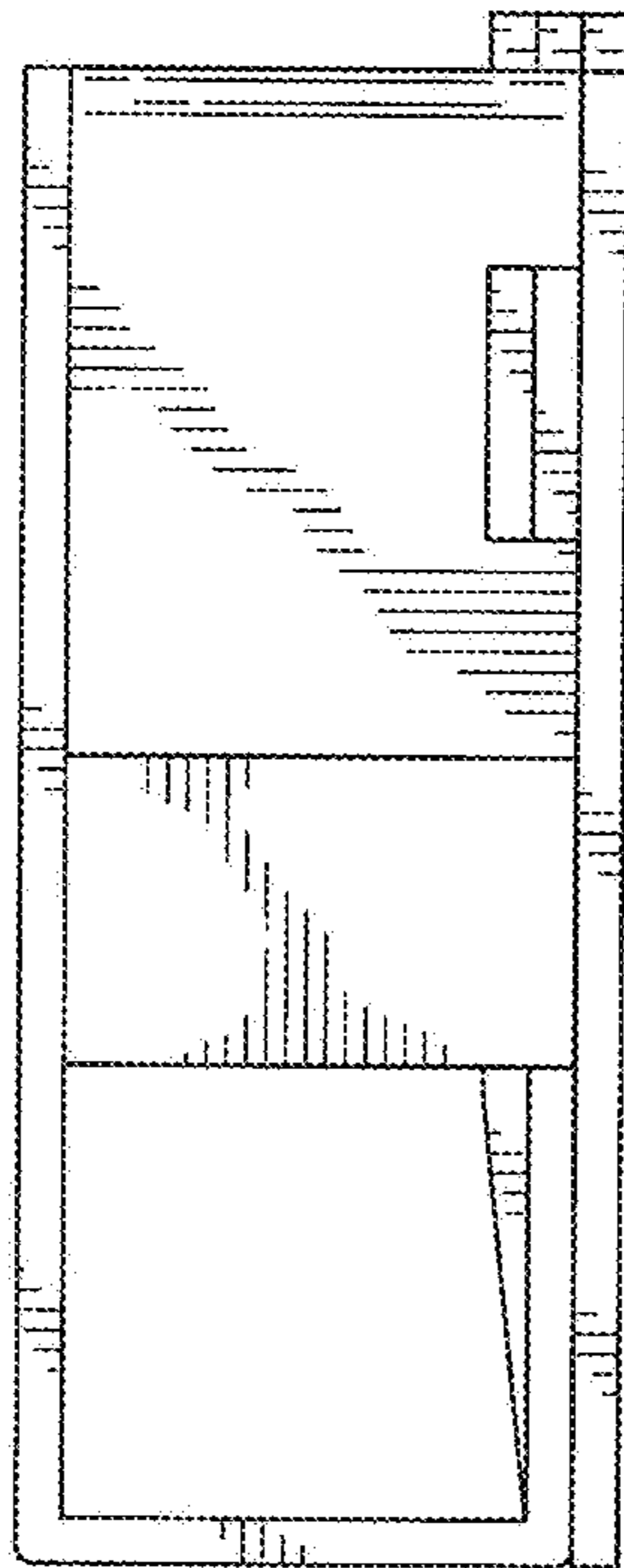

FIG. 5

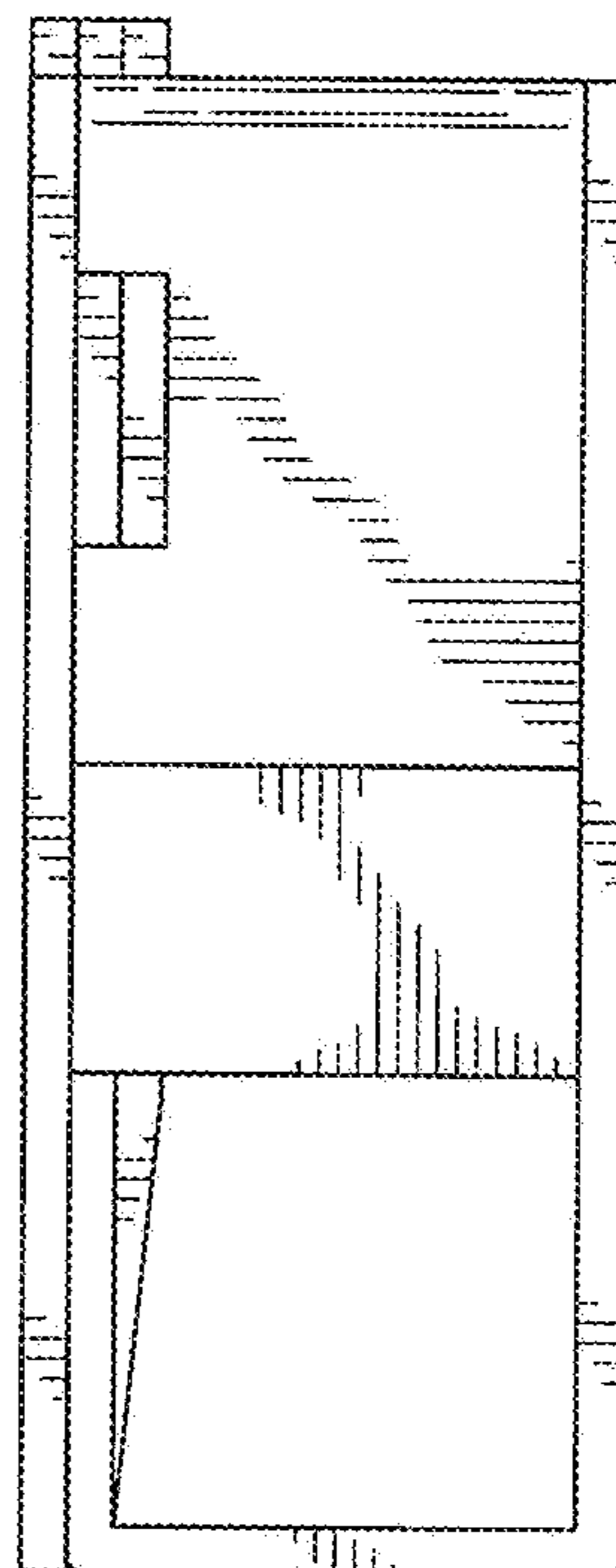

FIG. 6

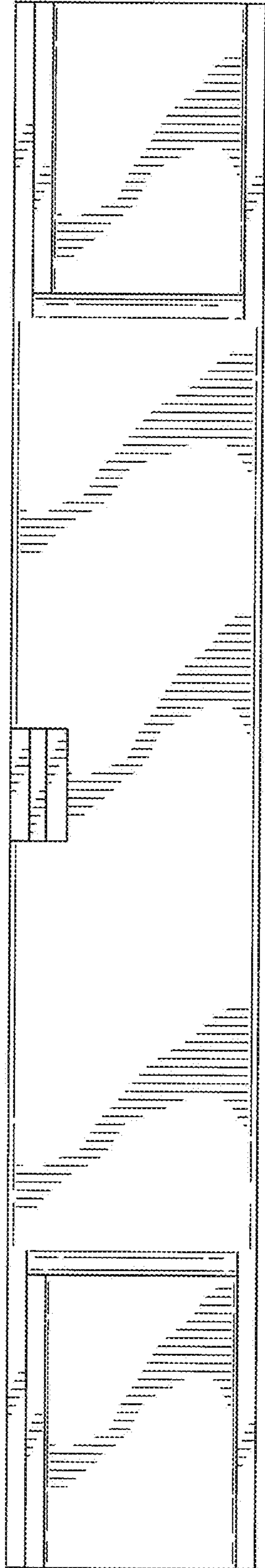

FIG. 7

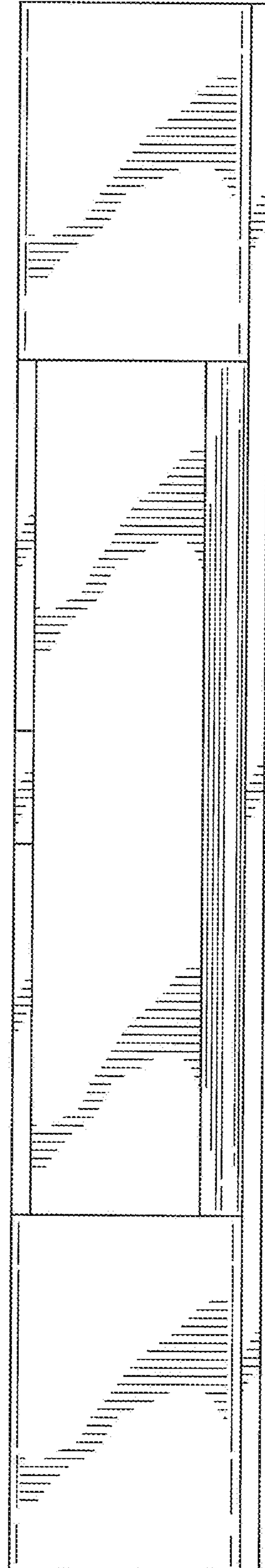

FIG. 8

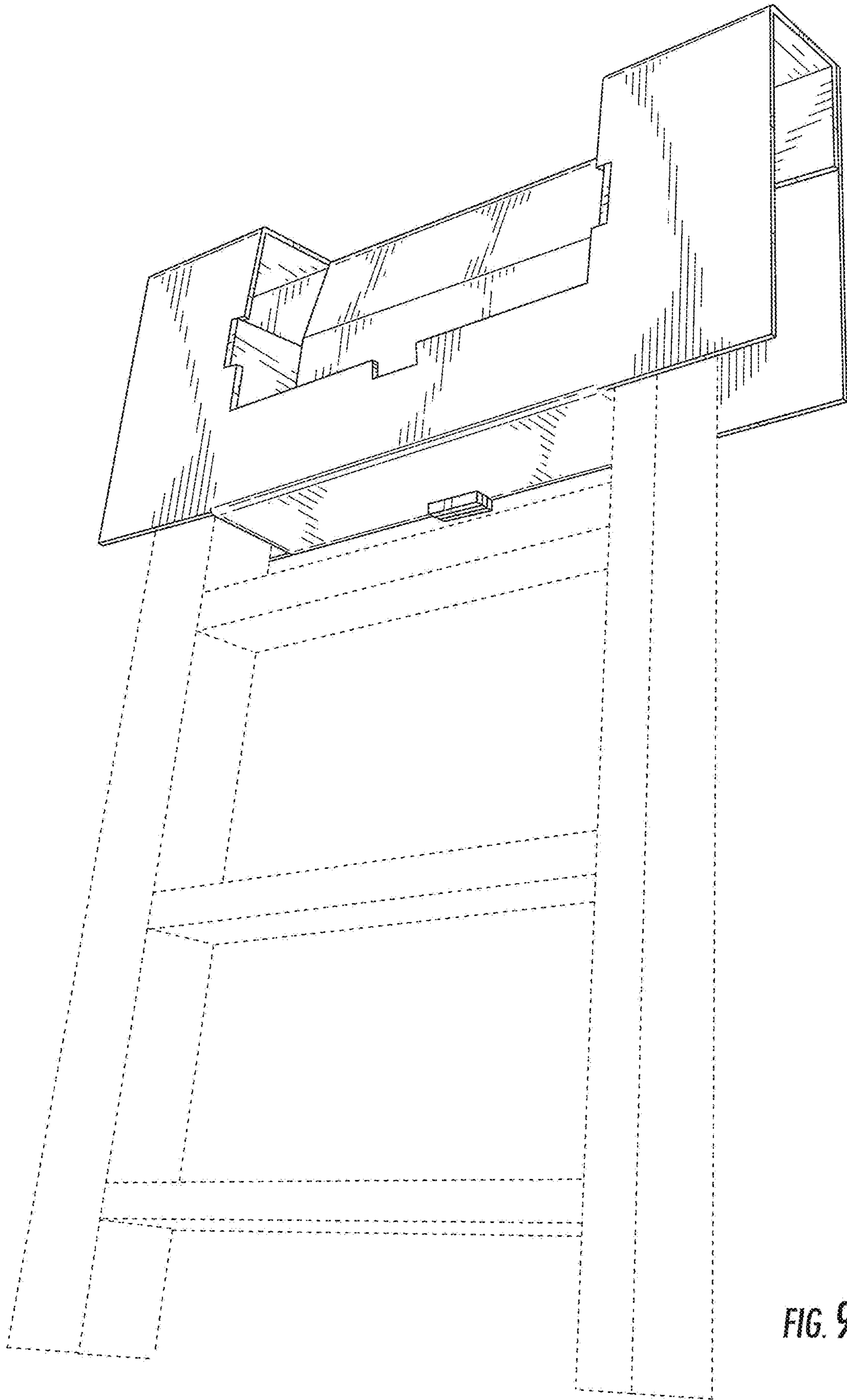

FIG. 9