



US00D884892S

(12) **United States Design Patent**  
**Hulford et al.**

(10) **Patent No.:** **US D884,892 S**

(45) **Date of Patent:** **\*\* May 19, 2020**

(54) **SURGICAL INSTRUMENT BACKEND HOUSING**

(71) Applicant: **Intuitive Surgical Operations, Inc.**,  
Sunnyvale, CA (US)

(72) Inventors: **Timothy B. Hulford**, San Jose, CA  
(US); **Robert Bruce Hubler**, San Jose,  
CA (US)

(73) Assignee: **INTUITIVE SURGICAL OPERATIONS, INC.**, Sunnyvale, CA  
(US)

(\*\*) Term: **15 Years**

(21) Appl. No.: **29/644,770**

(22) Filed: **Apr. 20, 2018**

(51) **LOC (12) Cl.** ..... **24-02**

(52) **U.S. Cl.**  
USPC ..... **D24/145**

(58) **Field of Classification Search**  
USPC ..... D24/144–145, 133, 127; 227/19  
(Continued)

(56) **References Cited**

**U.S. PATENT DOCUMENTS**

D428,487 S 7/2000 Renner  
D438,617 S 3/2001 Cooper et al.  
(Continued)

**FOREIGN PATENT DOCUMENTS**

WO WO-2018013217 A1 1/2018  
WO WO-2018013354 A1 1/2018

**OTHER PUBLICATIONS**

Co-pending U.S. Appl. No. 29/571,116, filed Jul. 14, 2016.  
(Continued)

*Primary Examiner* — Wan Laymon

(74) *Attorney, Agent, or Firm* — Jones Robb, PLLC

(57) **CLAIM**

The ornamental design for a surgical instrument backend housing, as shown and described.

**DESCRIPTION**

FIG. 1 is a front top perspective view of a first embodiment of a surgical instrument backend housing of our new design; FIG. 2 is another front top perspective view thereof; FIG. 3 is a rear top perspective view thereof; FIG. 4 is another rear top perspective view thereof; FIG. 5 is a front view thereof; FIG. 6 is a rear view thereof; FIG. 7 is a right side view thereof; FIG. 8 is a left side view thereof; FIG. 9 is a top view thereof; FIG. 10 is a front top perspective view of a second embodiment of a surgical instrument backend housing of our new design; FIG. 11 is another front top perspective view thereof; FIG. 12 is a rear top perspective view thereof; FIG. 13 is another rear top perspective view thereof; FIG. 14 is a front view thereof; FIG. 15 is a rear view thereof; FIG. 16 is a right side view thereof; FIG. 17 is a left side view thereof; FIG. 18 is a top view thereof; FIG. 19 is a front top perspective view of a third embodiment of a surgical instrument backend housing of our new design; FIG. 20 is another front top perspective view thereof; FIG. 21 is a rear top perspective view thereof; FIG. 22 is another rear top perspective view thereof; FIG. 23 is a front view thereof; FIG. 24 is a rear view thereof; FIG. 25 is a right side view thereof; FIG. 26 is a left side view thereof; FIG. 27 is a top view thereof; and, FIG. 28 is a perspective view of the first embodiment of the surgical instrument backend housing, including a shaft and an end effector that are depicted in broken lines to indicate an exemplary environment for the claimed design and do not form any part of the claimed design.

(Continued)

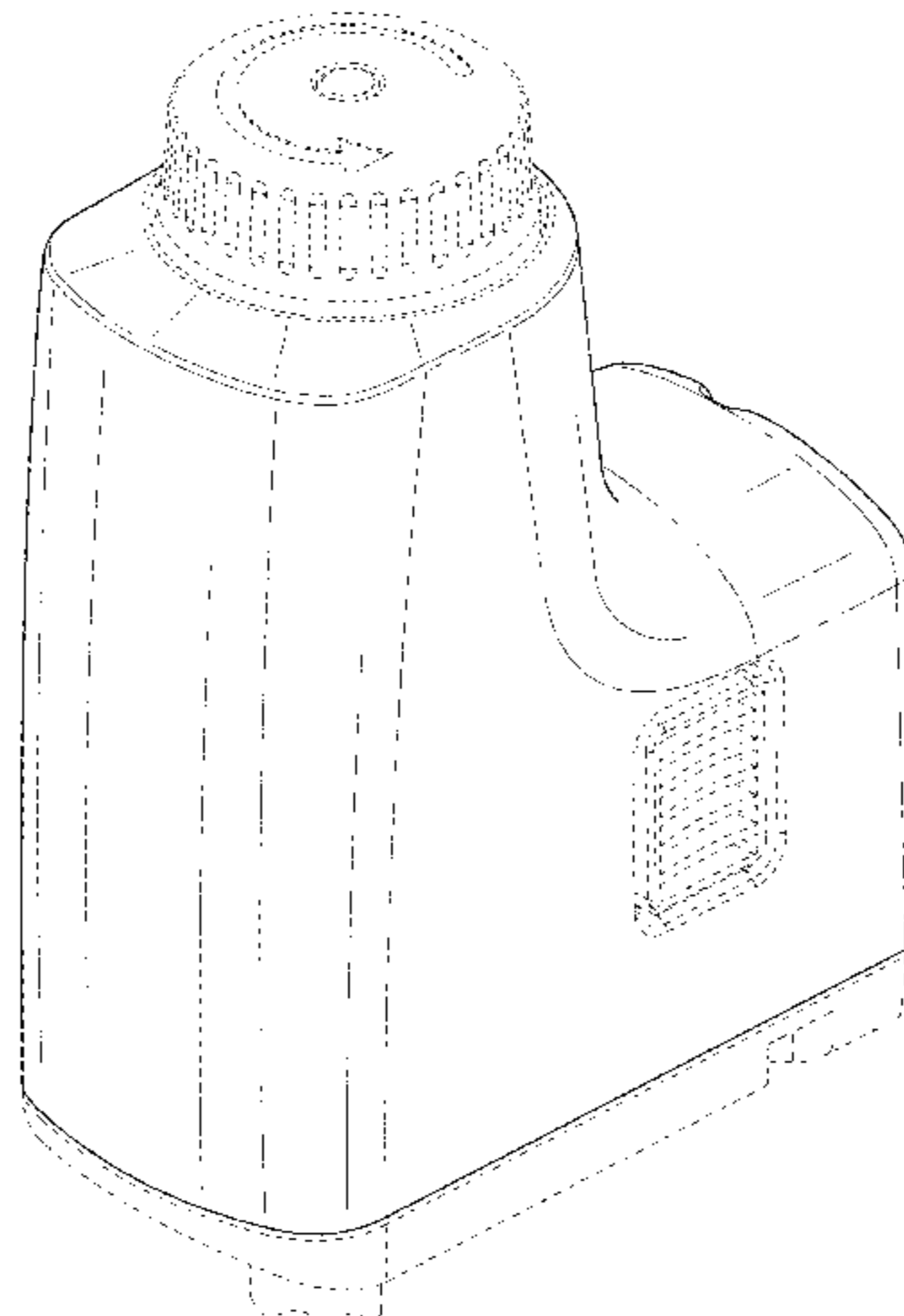

Bottom views of the surgical instrument backend housing embodiments are omitted as the bottom view forms no part of the claimed design.

The surgical instrument backend housing is not limited to the scale shown herein.

The shade lines in the Figures show contour and not surface ornamentation.

The broken lines in the Figures show unclaimed portions of the surgical instrument end portion and form no part of the claimed design.

**1 Claim, 25 Drawing Sheets**

(58) **Field of Classification Search**

CPC . A61B 17/115; A61B 17/068; A61B 17/0684;  
A61B 17/0686; A61B 2017/07214; A61B  
2017/07257

See application file for complete search history.

(56) **References Cited**

U.S. PATENT DOCUMENTS

D441,076	S	4/2001	Cooper et al.
D444,555	S	7/2001	Cooper et al.
D481,125	S	10/2003	Hayamizu et al.
D490,898	S	6/2004	Hayamizu et al.
6,742,413	B2	6/2004	Schwital et al.
D497,428	S	10/2004	Hayamizu et al.
D498,533	S	11/2004	Hayamizu et al.
D507,349	S	7/2005	Banks et al.
7,140,151	B2	11/2006	Spaziani et al.
D534,655	S	1/2007	Iranyi et al.
D577,823	S	9/2008	Hensler et al.
D637,287	S	5/2011	Mudd et al.
D652,923	S	1/2012	Kennedy et al.
D657,057	S	4/2012	Kearsley
8,224,484	B2	7/2012	Swarup et al.
8,323,213	B2	12/2012	Kim
8,375,808	B2	2/2013	Blumenkranz et al.

8,423,186	B2	4/2013	Itkowitz et al.
8,466,811	B2	6/2013	Kang et al.
D687,599	S	8/2013	Amit
D705,488	S	5/2014	Cheng
8,740,880	B2	6/2014	Pinault et al.
8,862,268	B2	10/2014	Robinson et al.
9,089,972	B2	7/2015	Stuart et al.
9,161,772	B2	10/2015	Hyodo
9,162,358	B2	10/2015	Geffard et al.
9,204,934	B2	12/2015	Ogawa et al.
D760,387	S	6/2016	Waters et al.
D767,129	S	9/2016	Waters et al.
D767,130	S	9/2016	Waters et al.
D768,295	S	10/2016	Waters et al.
D843,575	S *	3/2019	Hulford ..... D24/145
2005/0251110	A1	11/2005	Nixon
2006/0074406	A1	4/2006	Cooper et al.
2007/0005002	A1	1/2007	Millman et al.
2007/0142824	A1	6/2007	Devengenzo et al.
2008/0139964	A1	6/2008	Murray et al.
2009/0248036	A1	10/2009	Hoffman et al.
2010/0169815	A1	7/2010	Zhao et al.
2011/0071473	A1	3/2011	Rogers et al.
2011/0071543	A1	3/2011	Prisco et al.
2011/0118748	A1	5/2011	Itkowitz
2012/0215220	A1	8/2012	Manzo et al.
2013/0046318	A1	2/2013	Radgowski et al.
2014/0081455	A1	3/2014	Goldberg et al.
2014/0128886	A1	5/2014	Holop et al.
2014/0338477	A1	11/2014	Donlon et al.
2015/0257814	A1	9/2015	Berry et al.

OTHER PUBLICATIONS

Co-pending U.S. Appl. No. 29/571,119, filed Jul. 14, 2016.  
Co-pending U.S. Appl. No. 29/571,120, filed Jul. 14, 2016.  
Co-pending U.S. Appl. No. 29/485,142, filed Mar. 17, 2014.  
Co-pending U.S. Appl. No. 29/485,144, filed Mar. 17, 2014.  
Co-pending U.S. Appl. No. 29/485,147, filed Mar. 17, 2014.  
Vertut, Jean and Phillipe Coiffet, Robot Technology: Teleoperation and Robotics Evolution and Development, English translation, Prentice-Hall, Inc., Inglewood Cliffs, NJ, USA 1986, vol. 3A, 332 pages.

\* cited by examiner

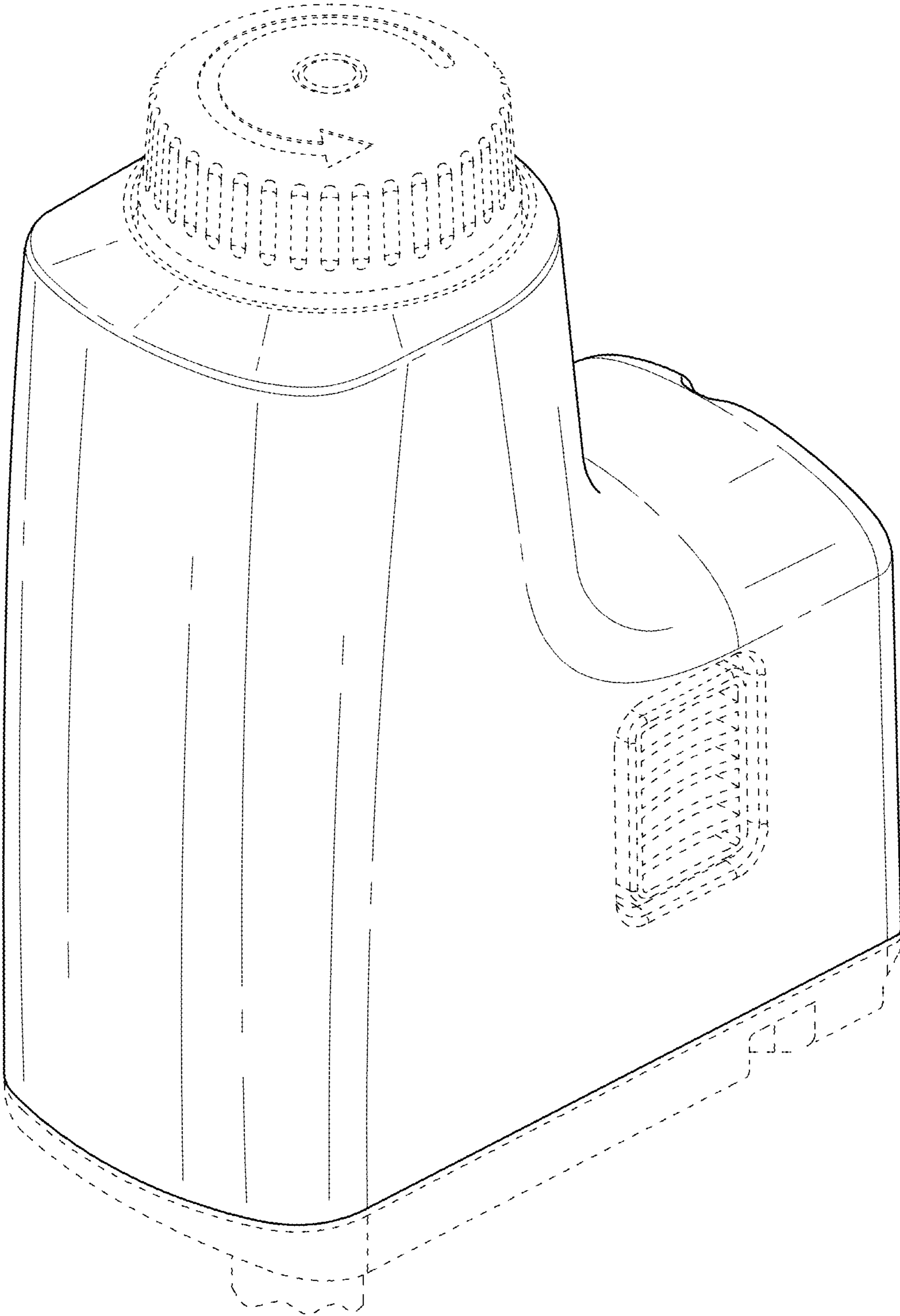

FIG. 1

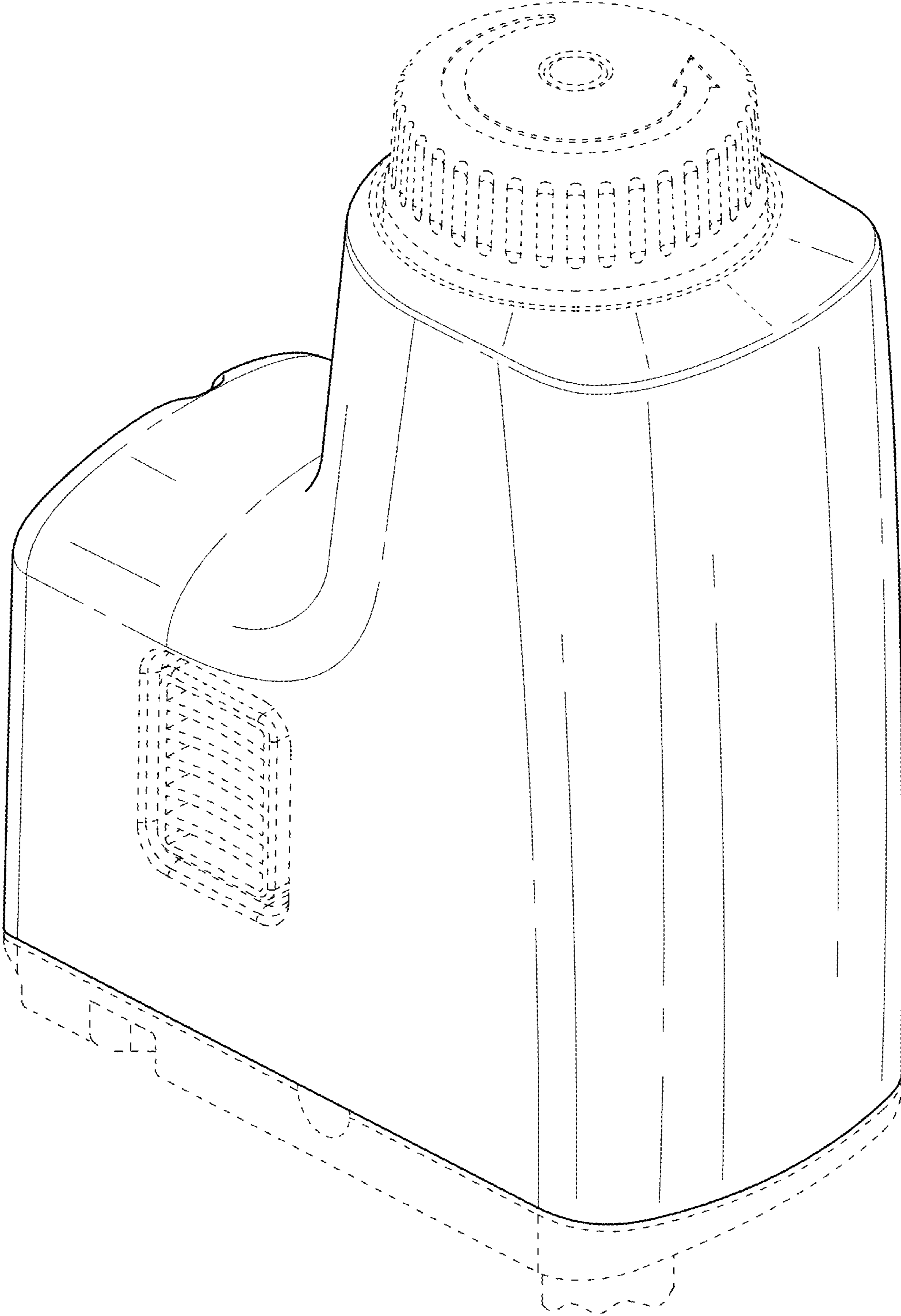

FIG. 2

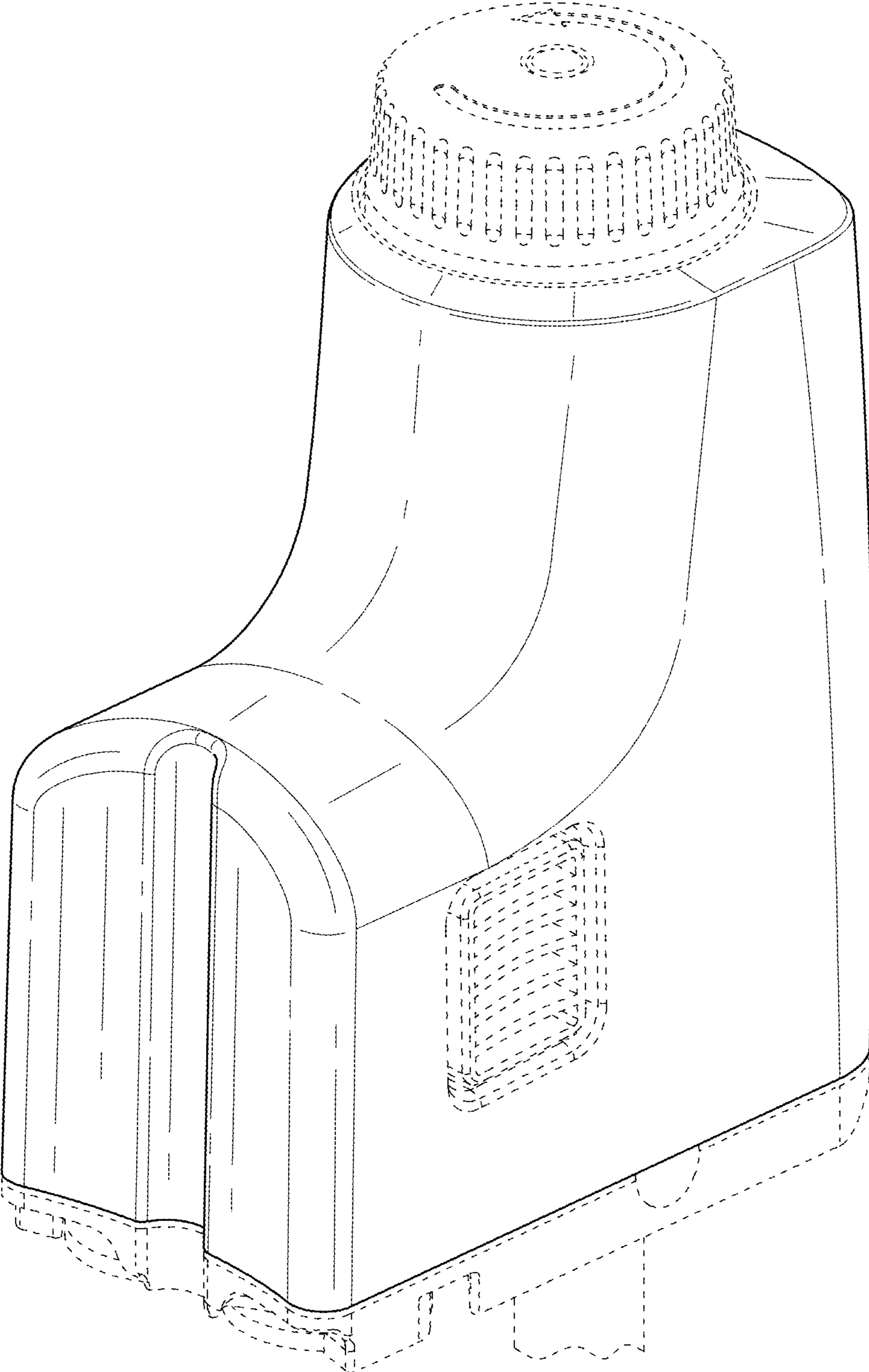

FIG. 3

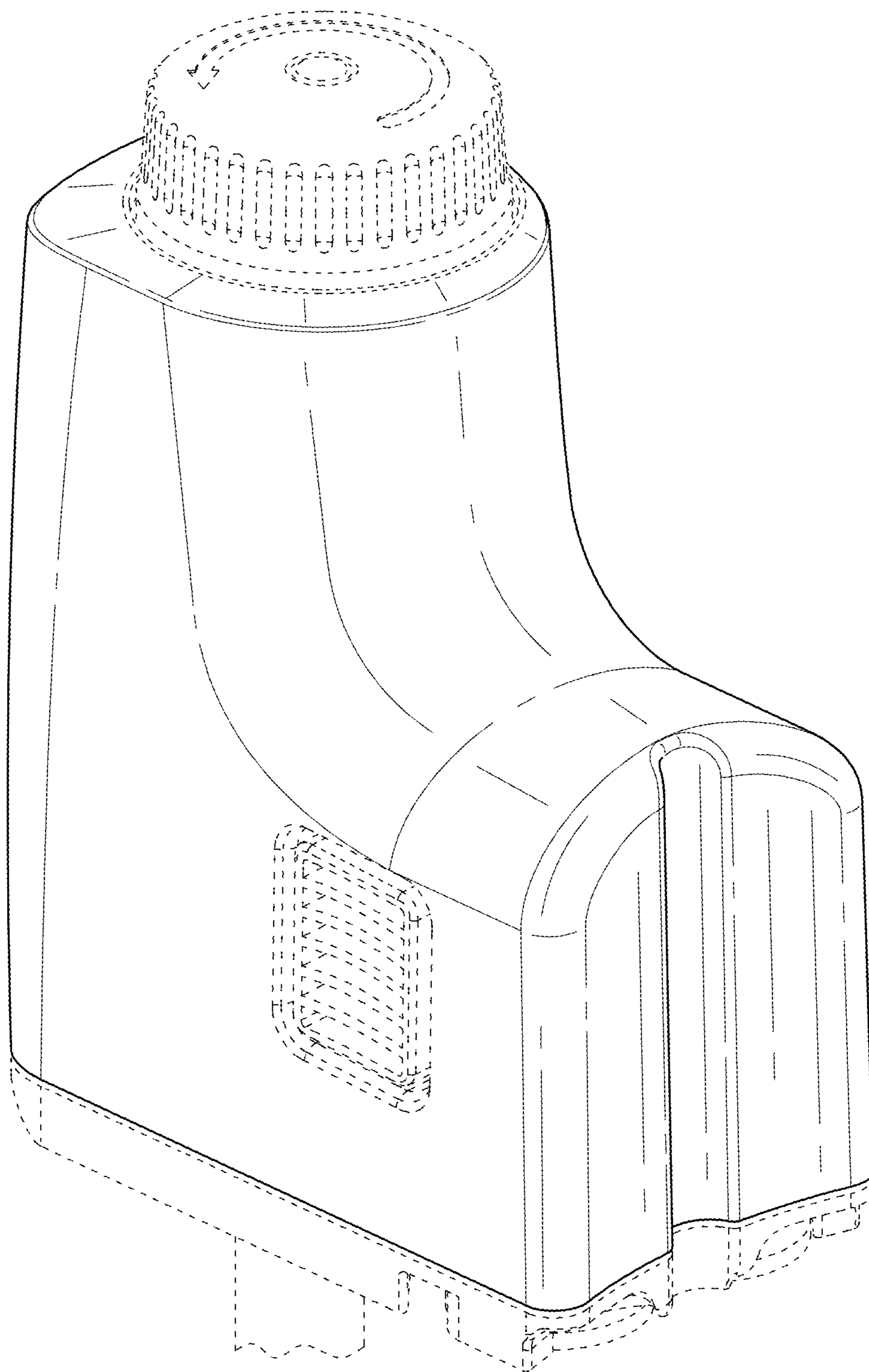

FIG. 4

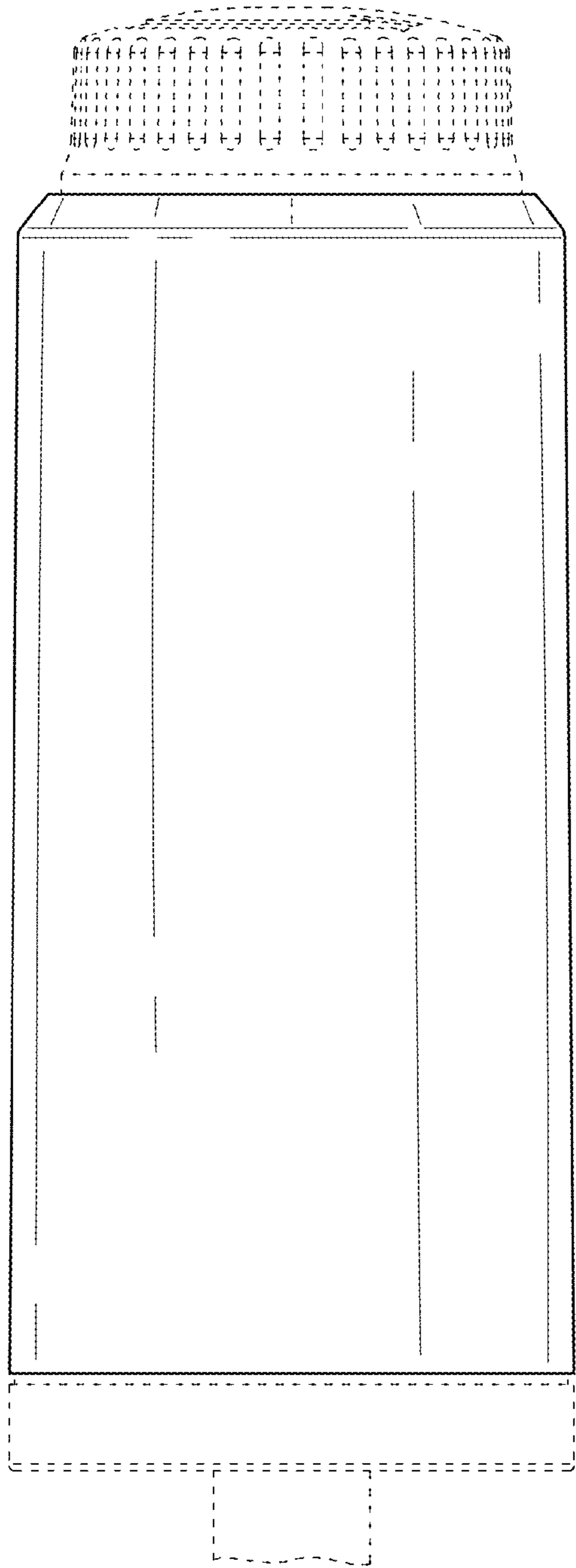

FIG. 5

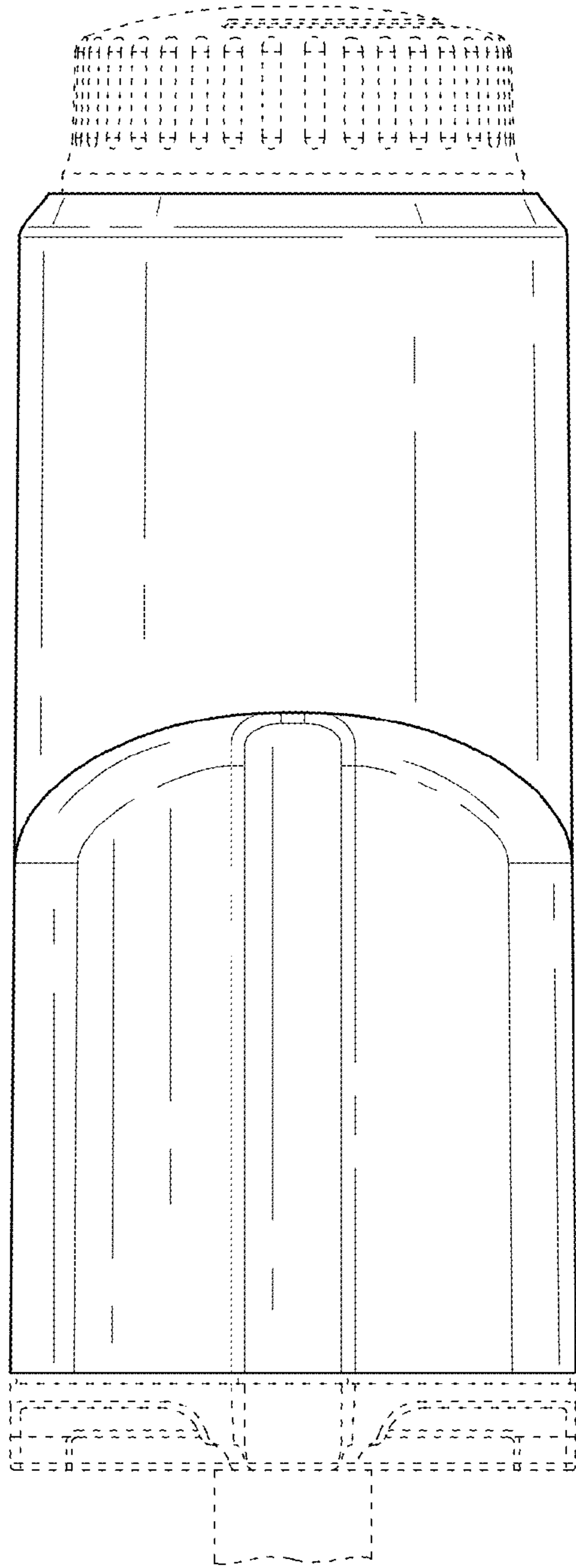

FIG. 6

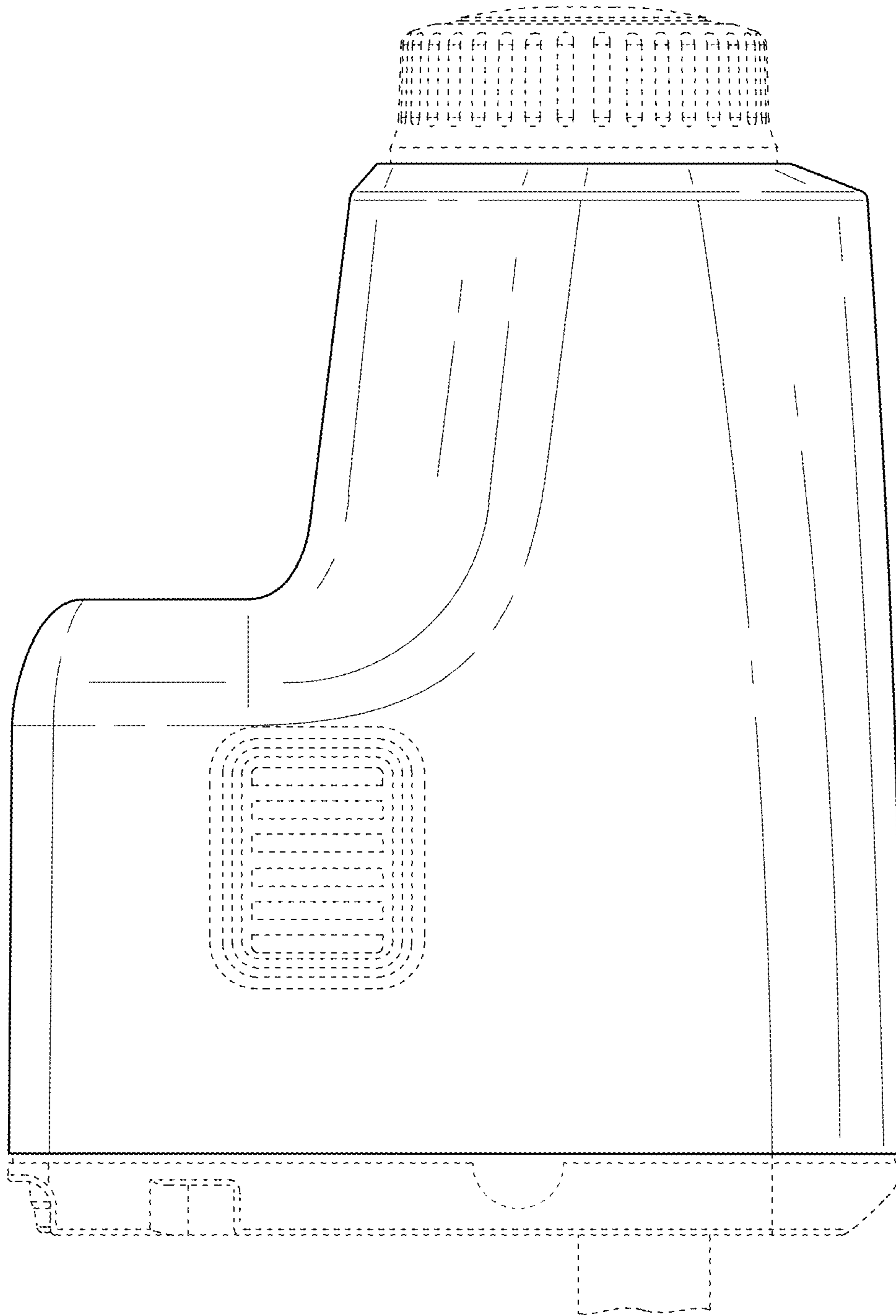

FIG. 7



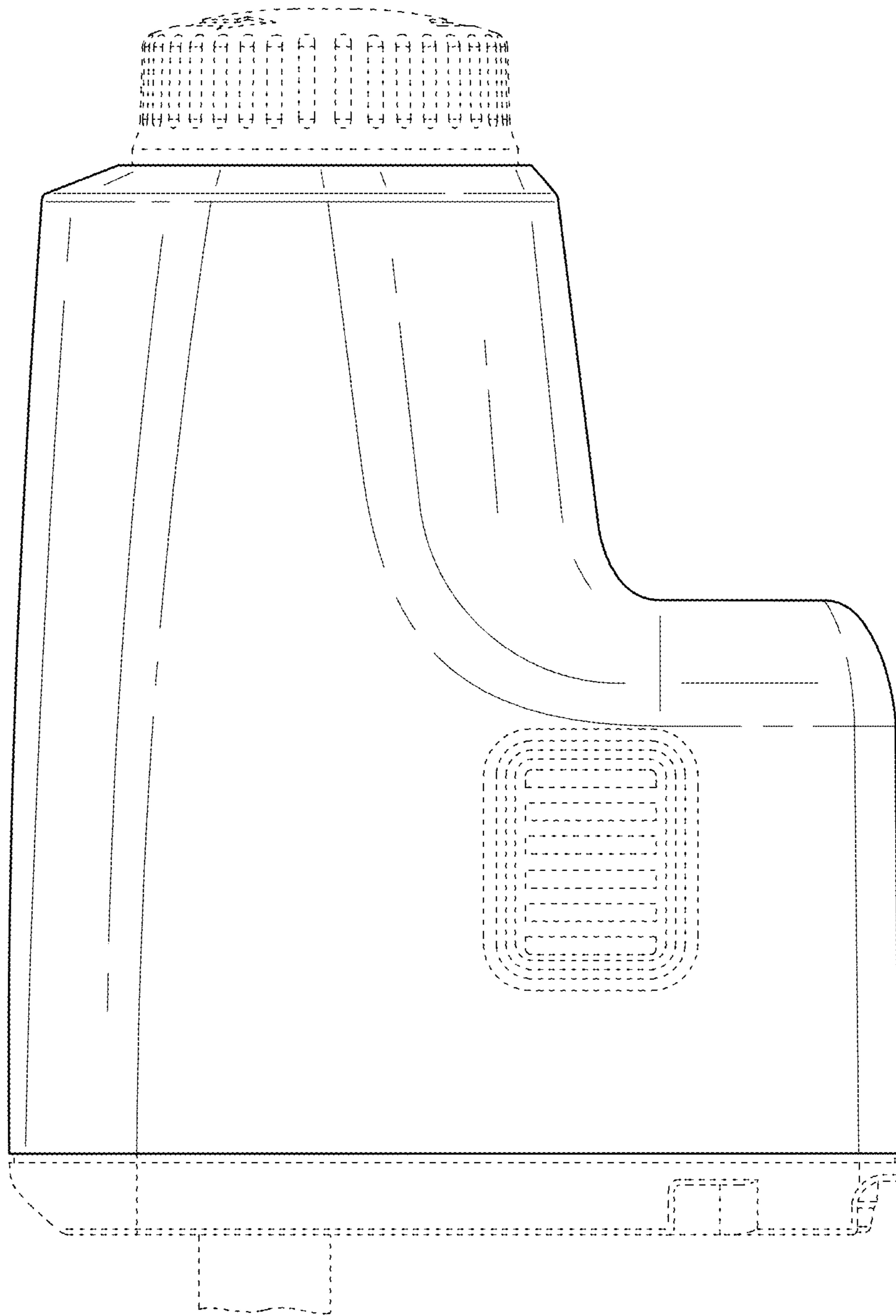

FIG. 8

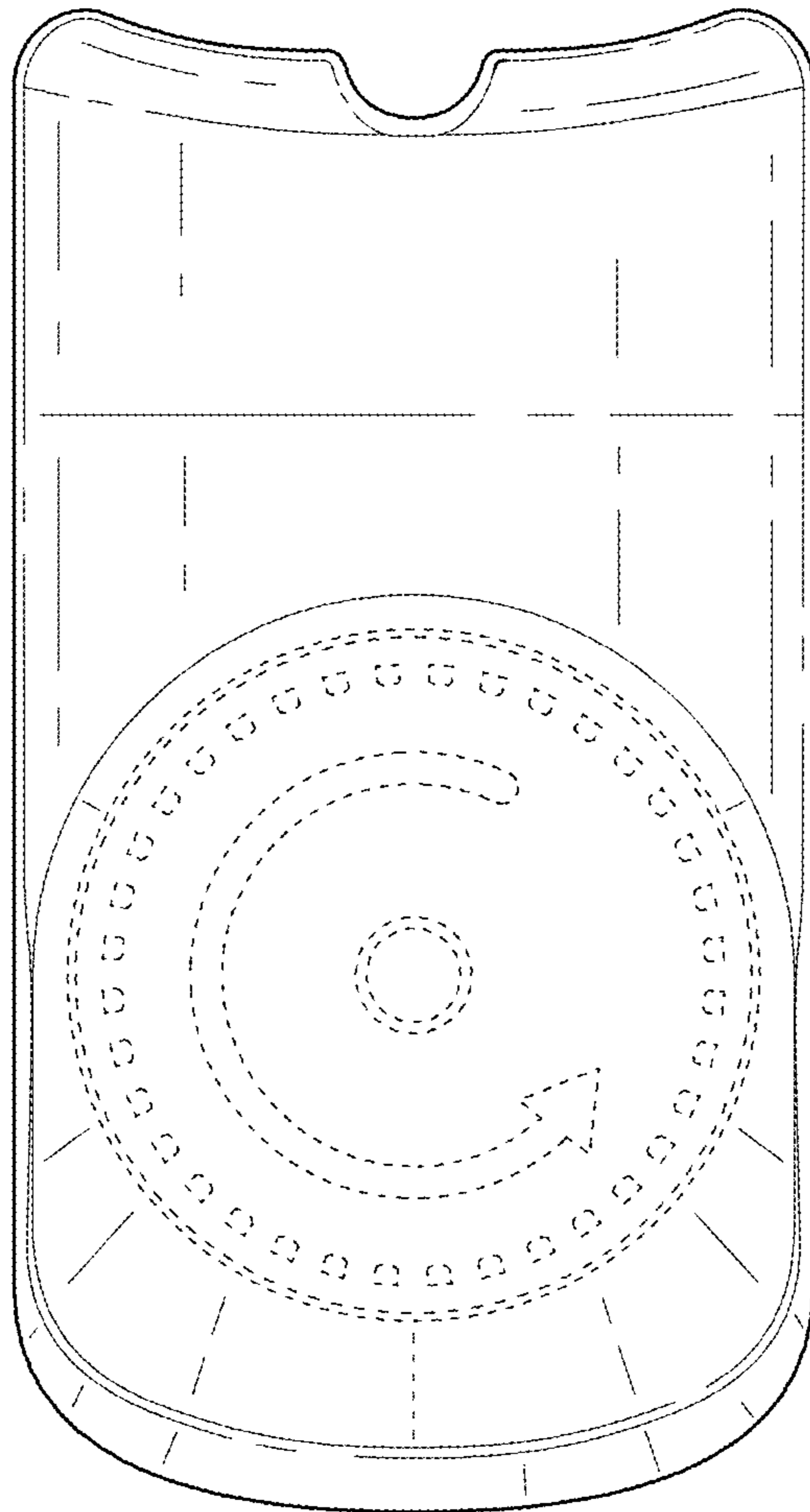

FIG. 9

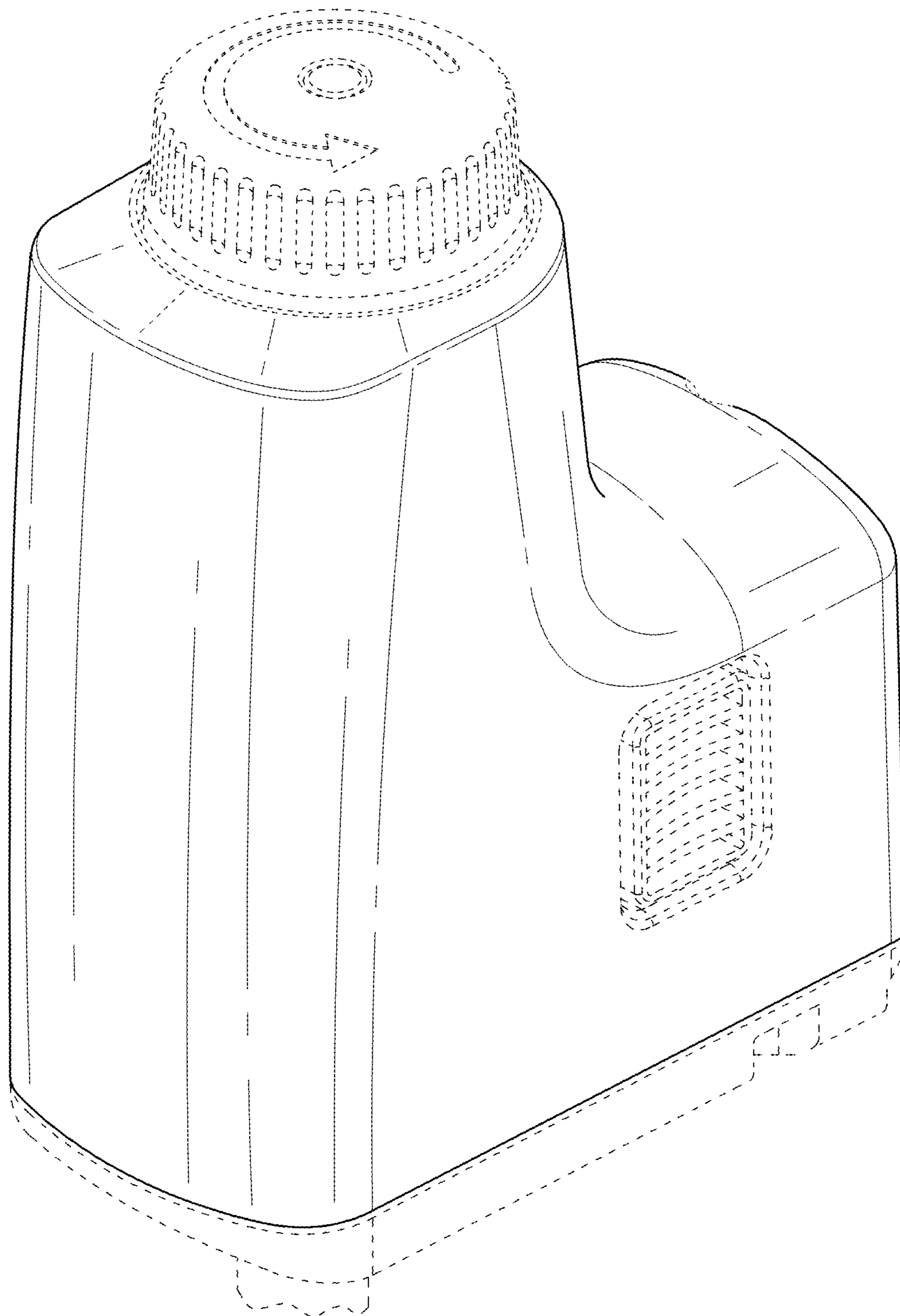

FIG. 10

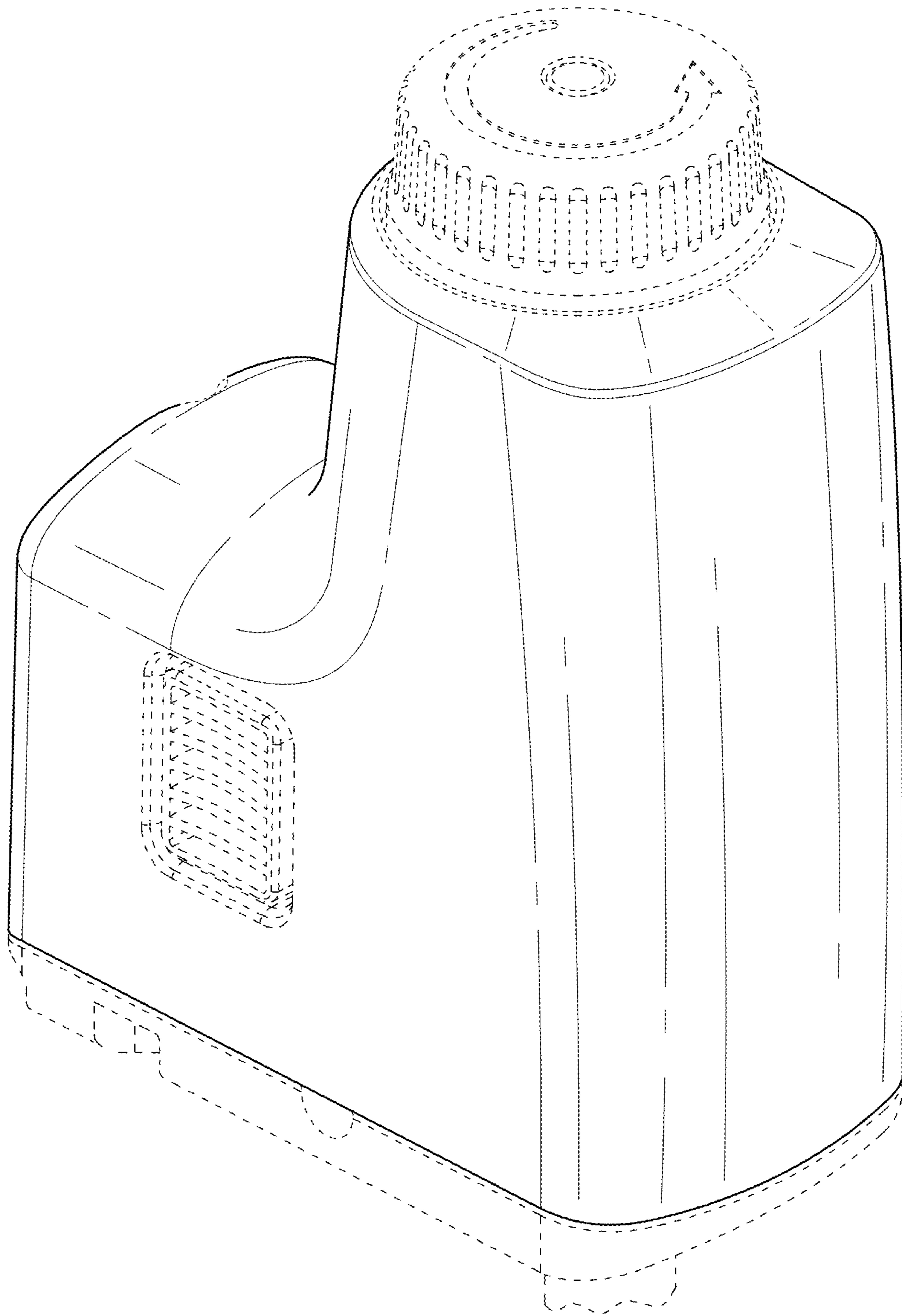

FIG. 11

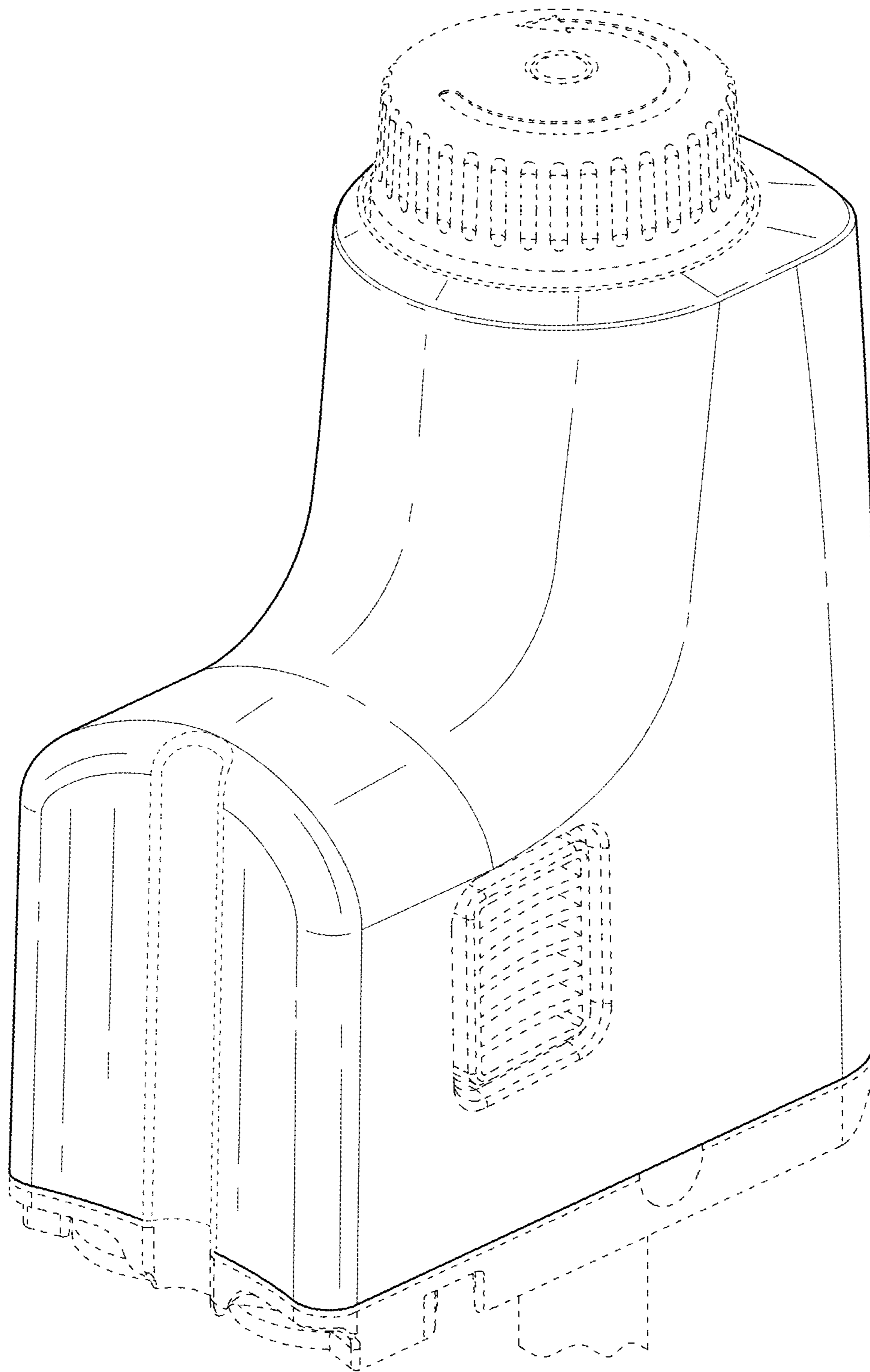

FIG. 12

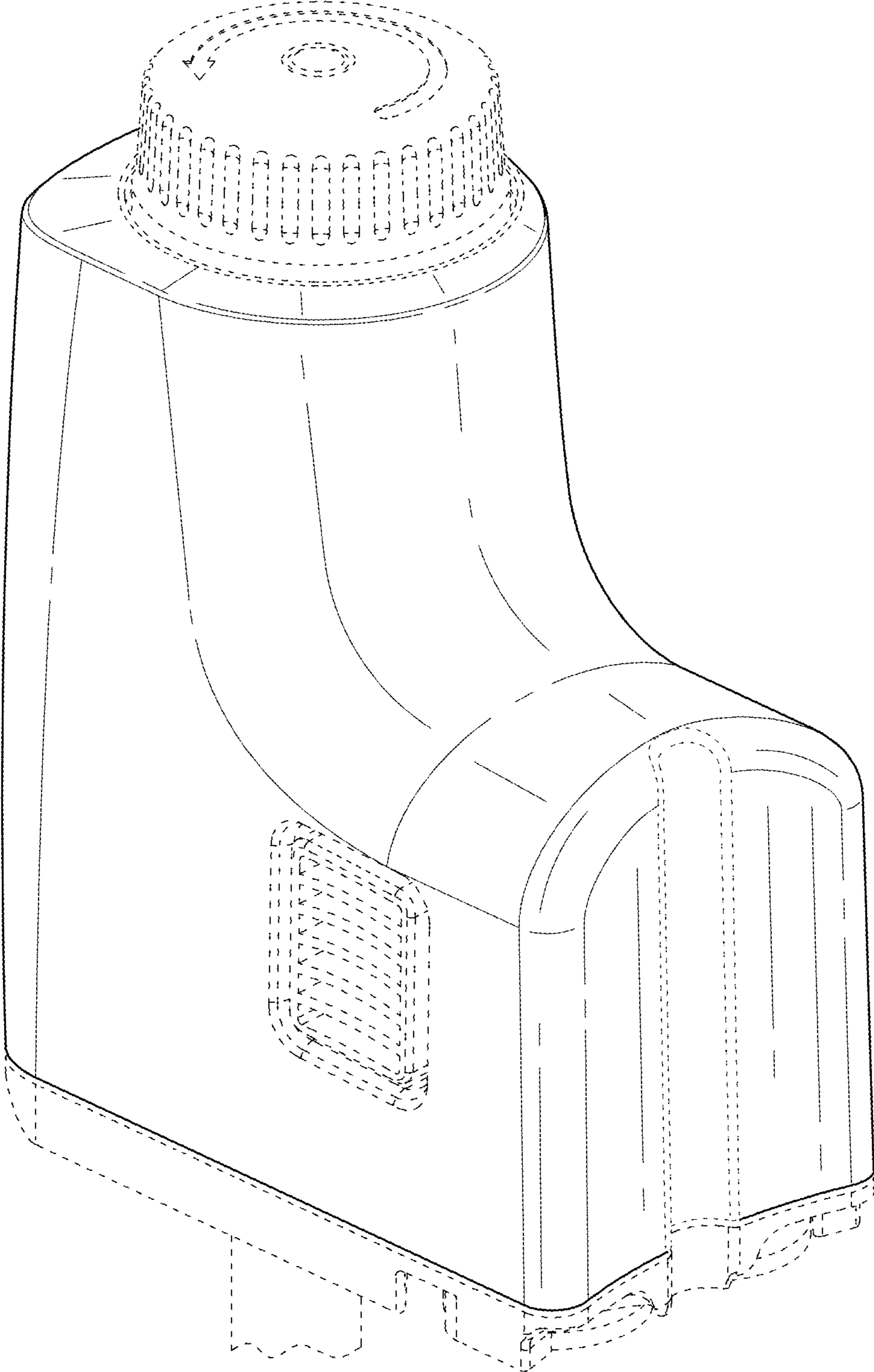

FIG. 13

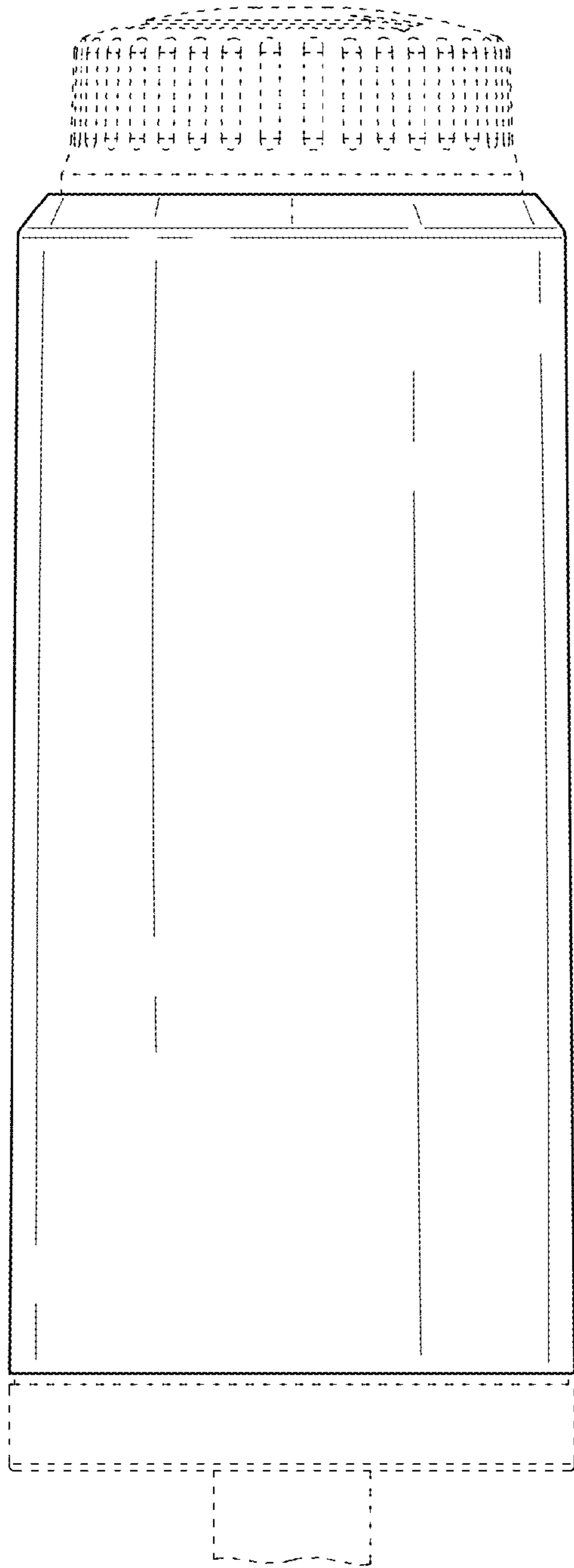

FIG. 14

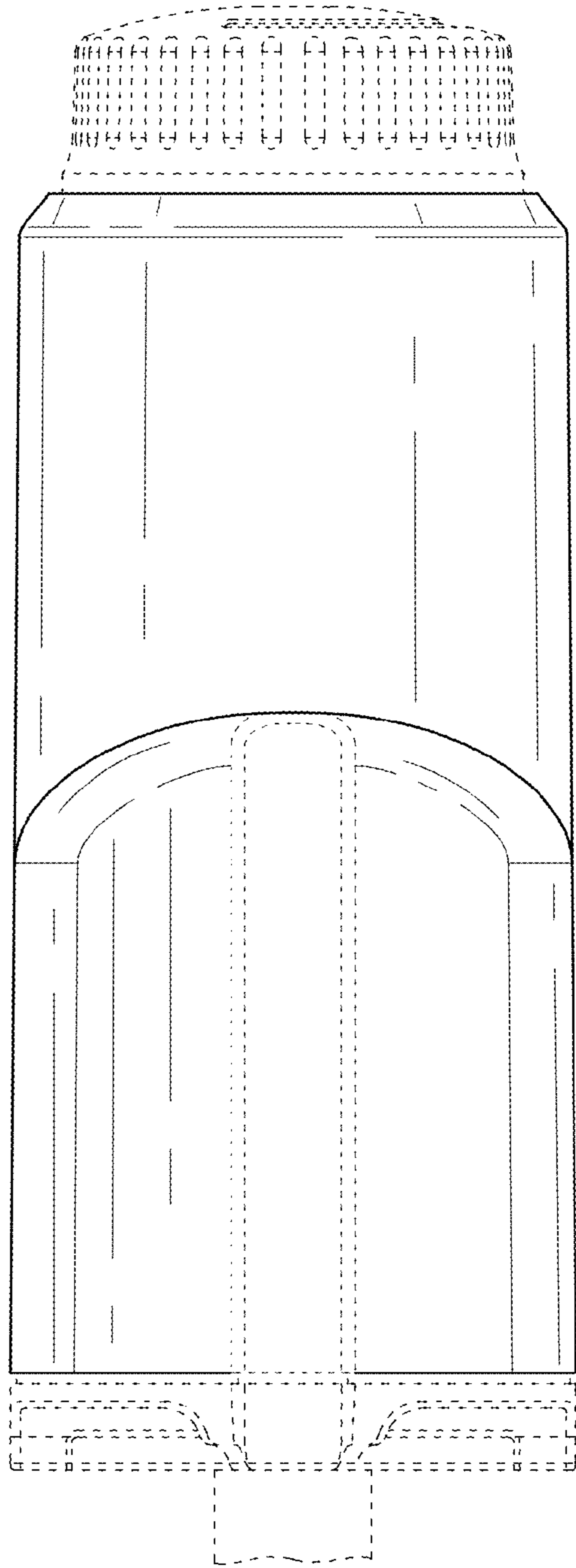

FIG. 15

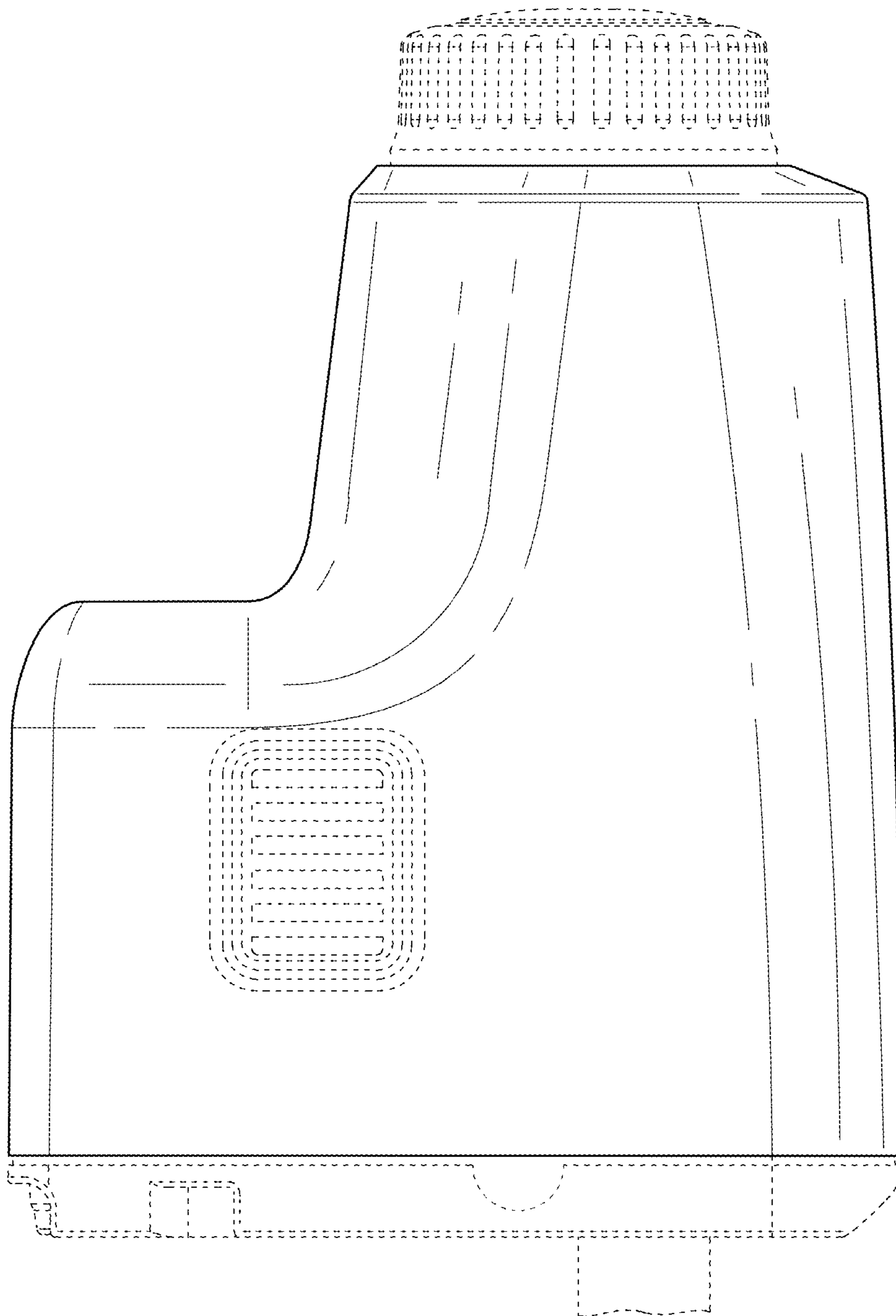

FIG. 16



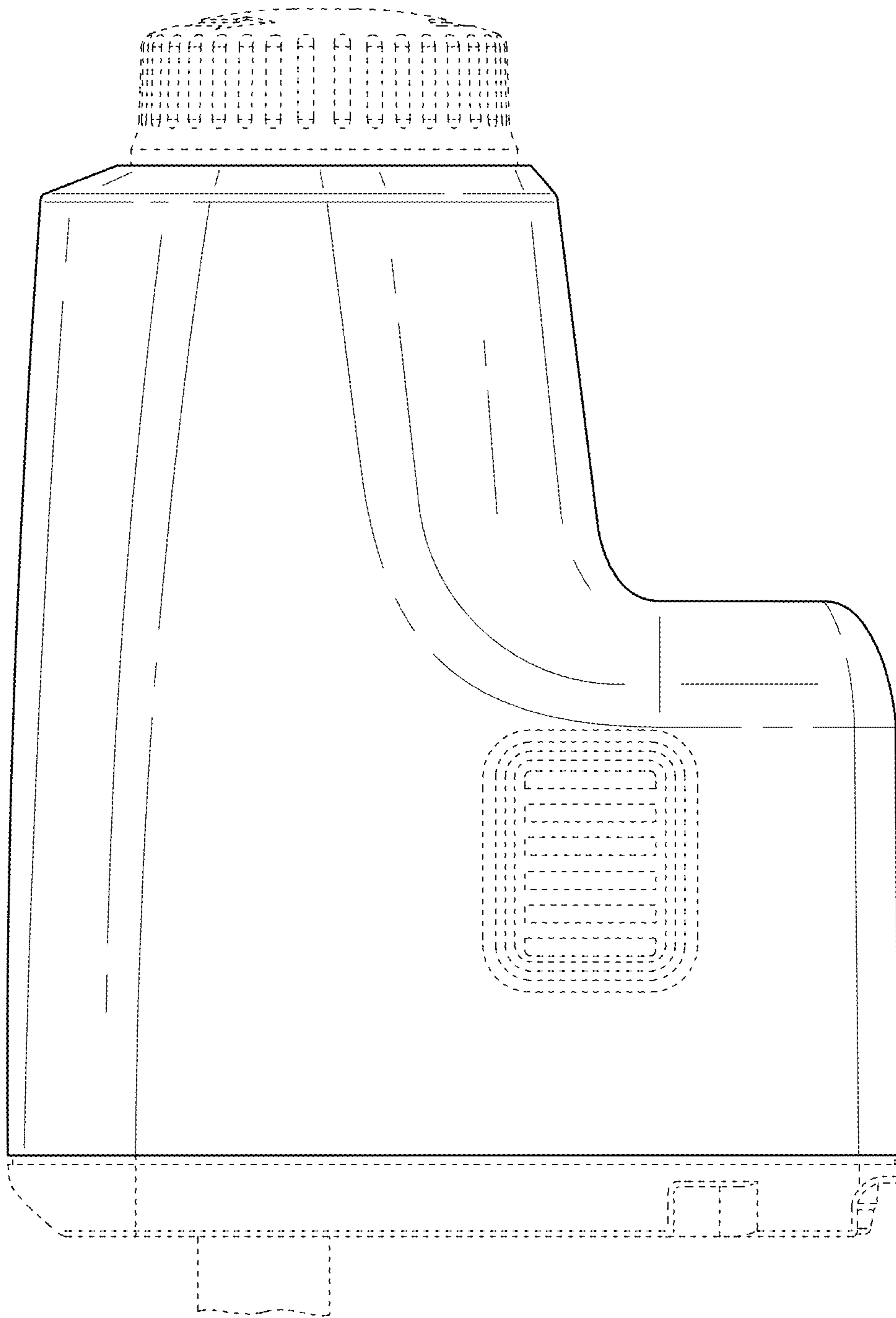

FIG. 17

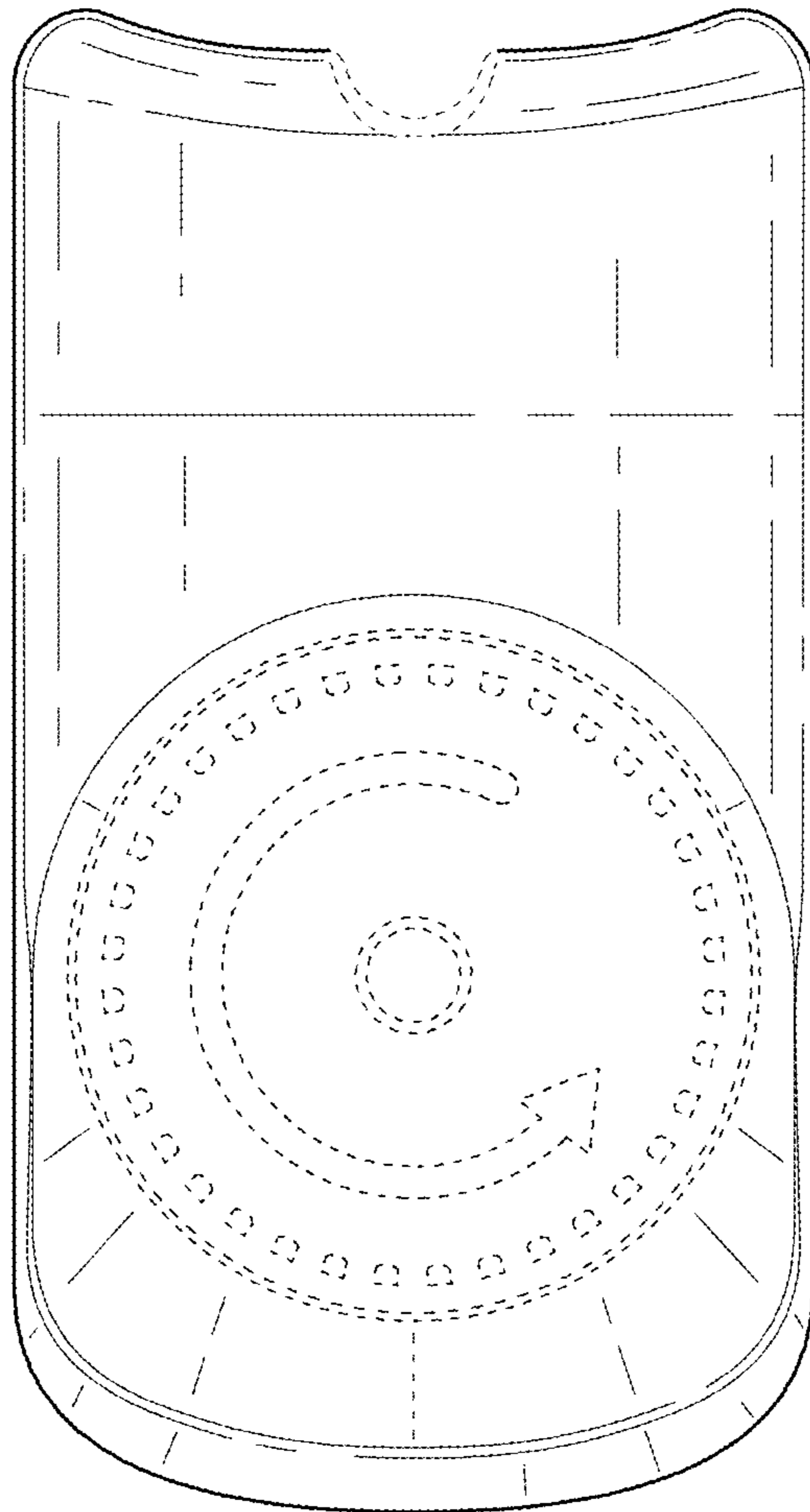

FIG. 18

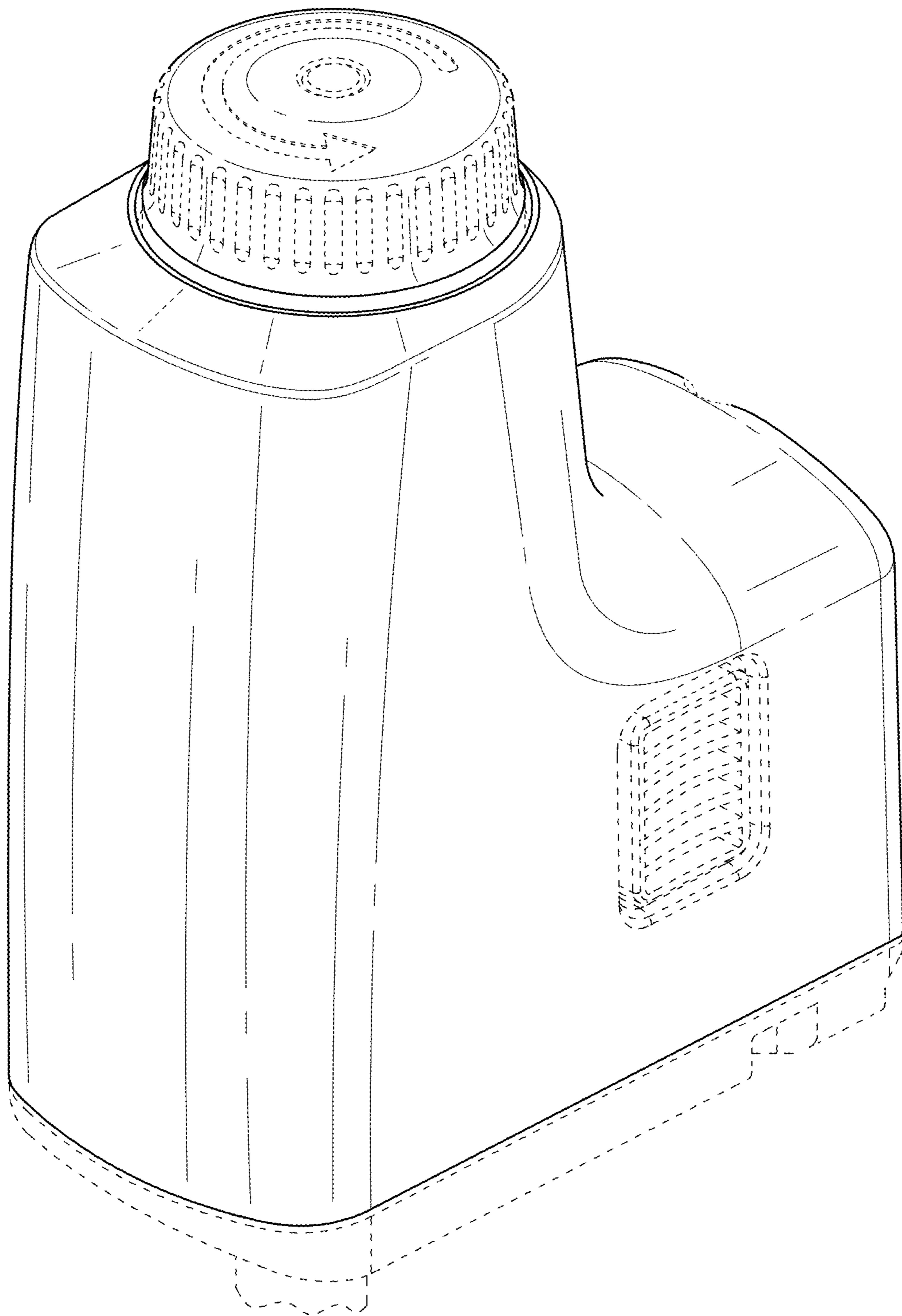

FIG. 19

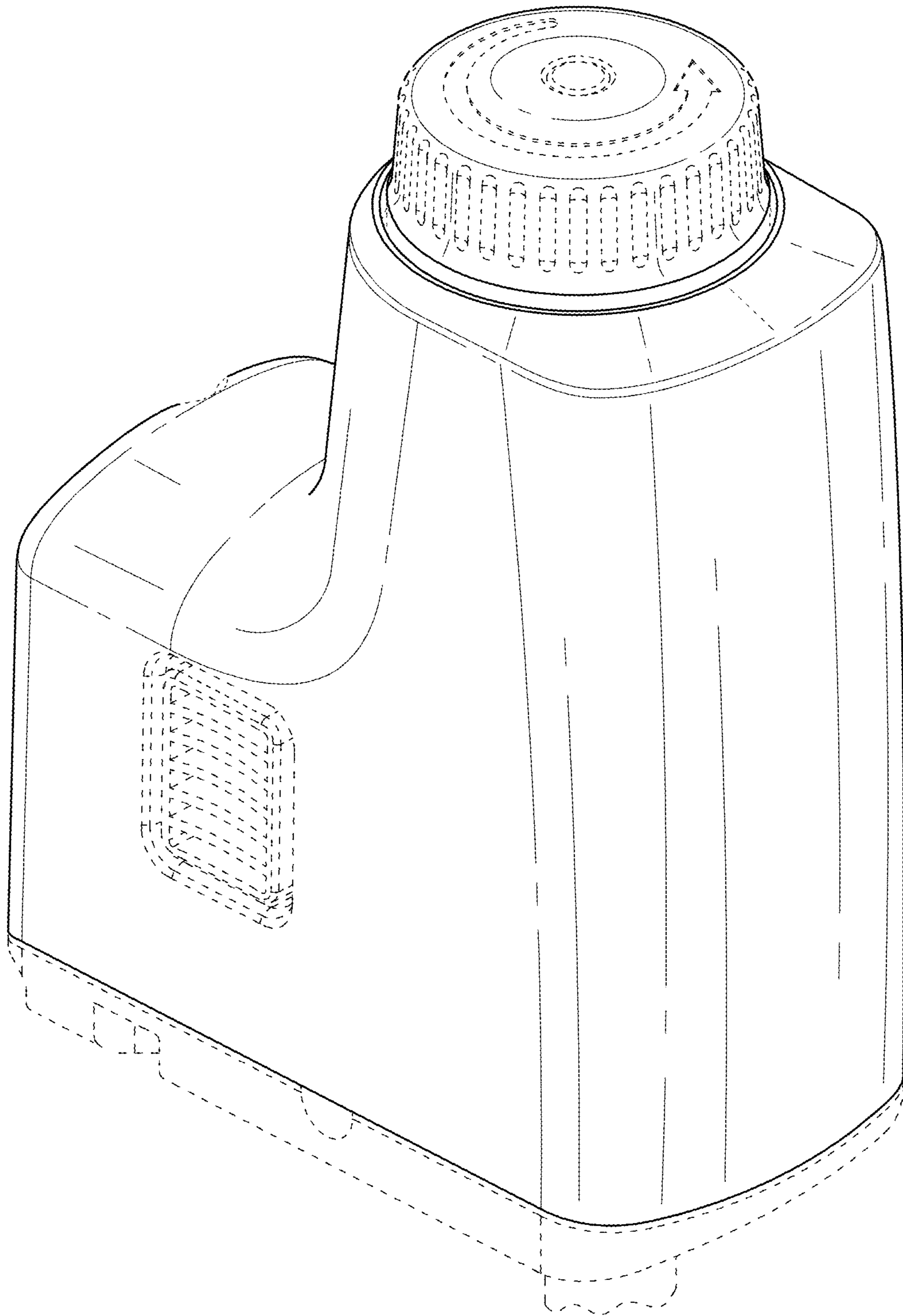

FIG. 20

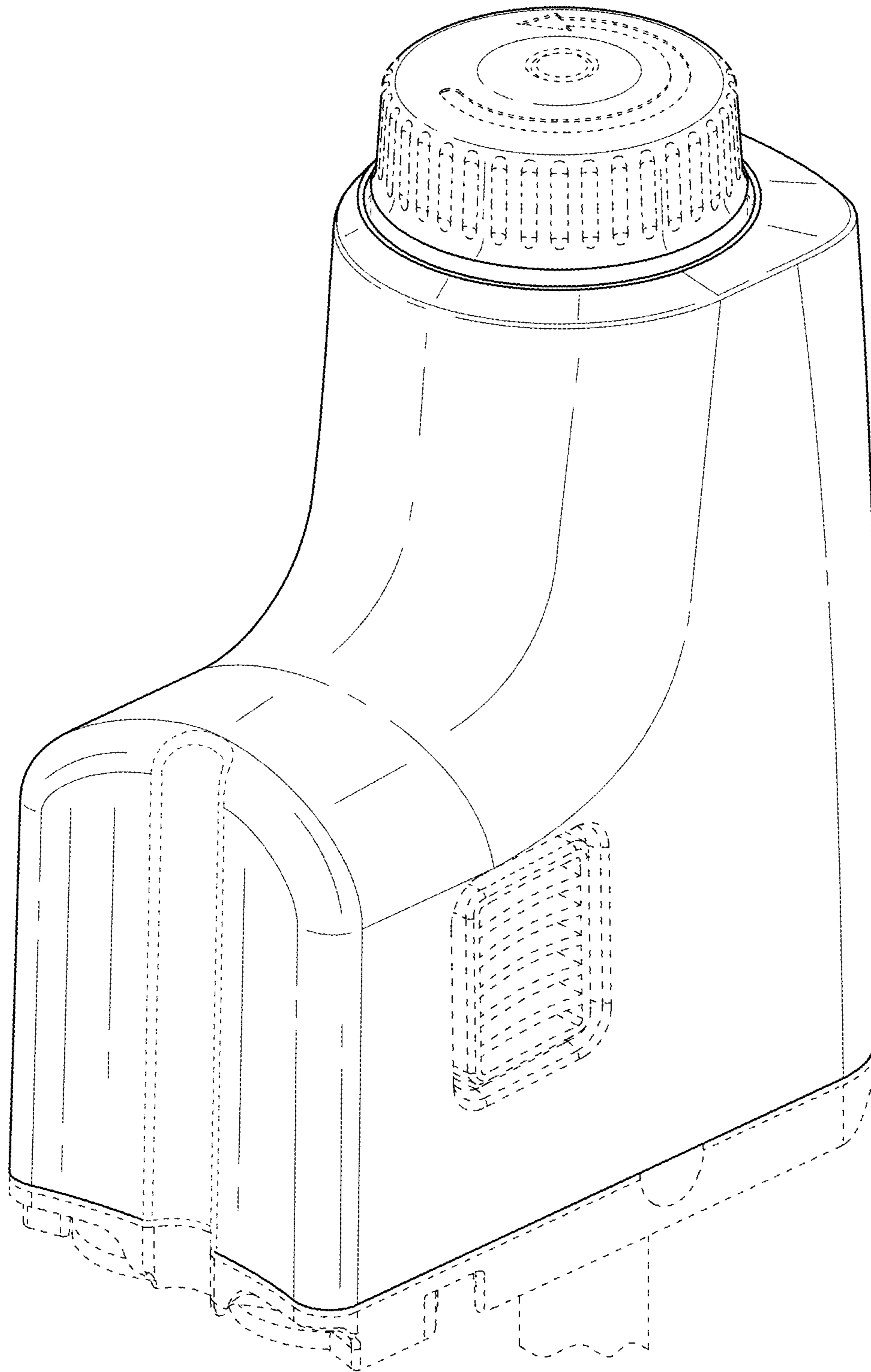

FIG. 21

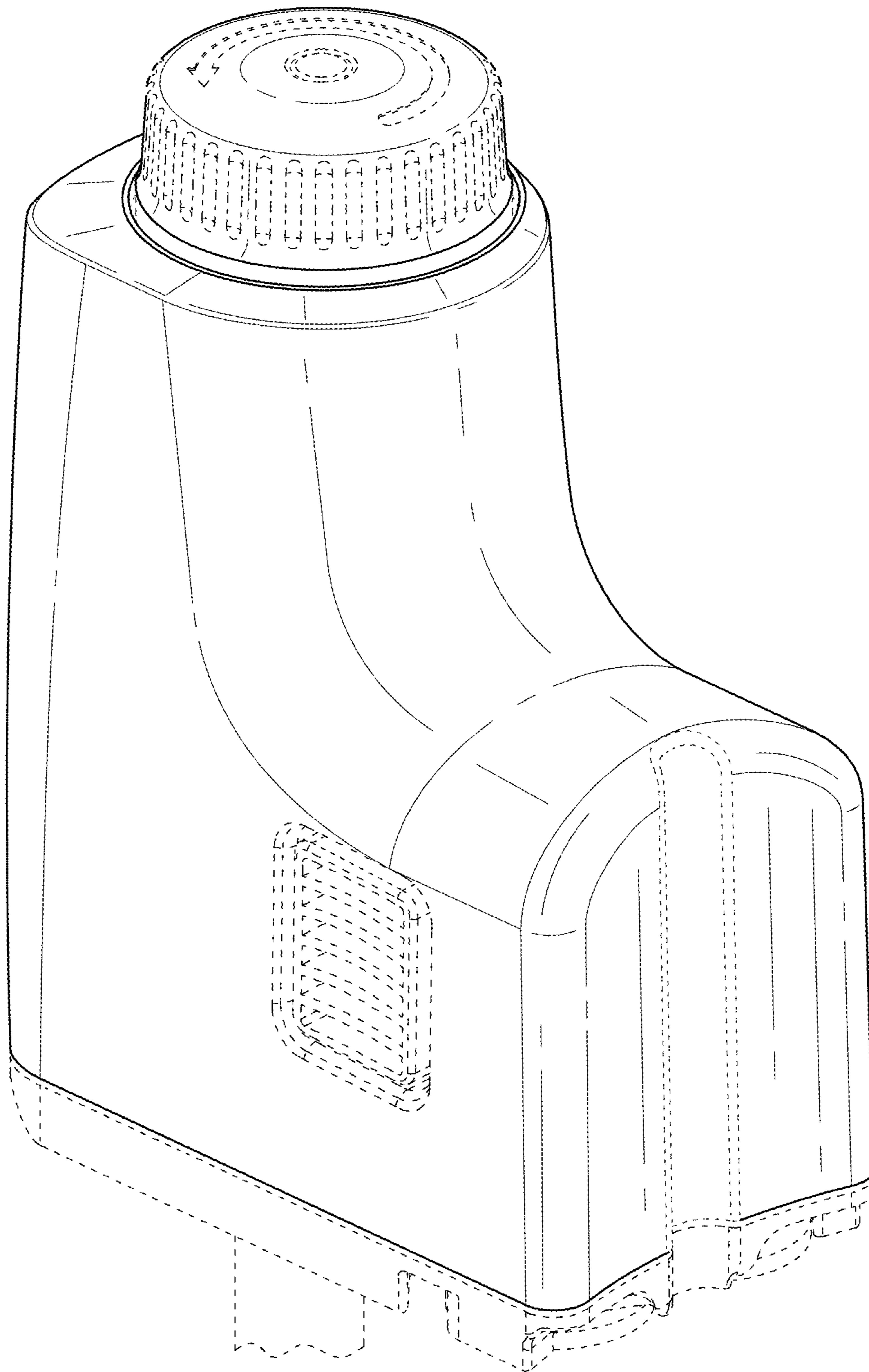

FIG. 22

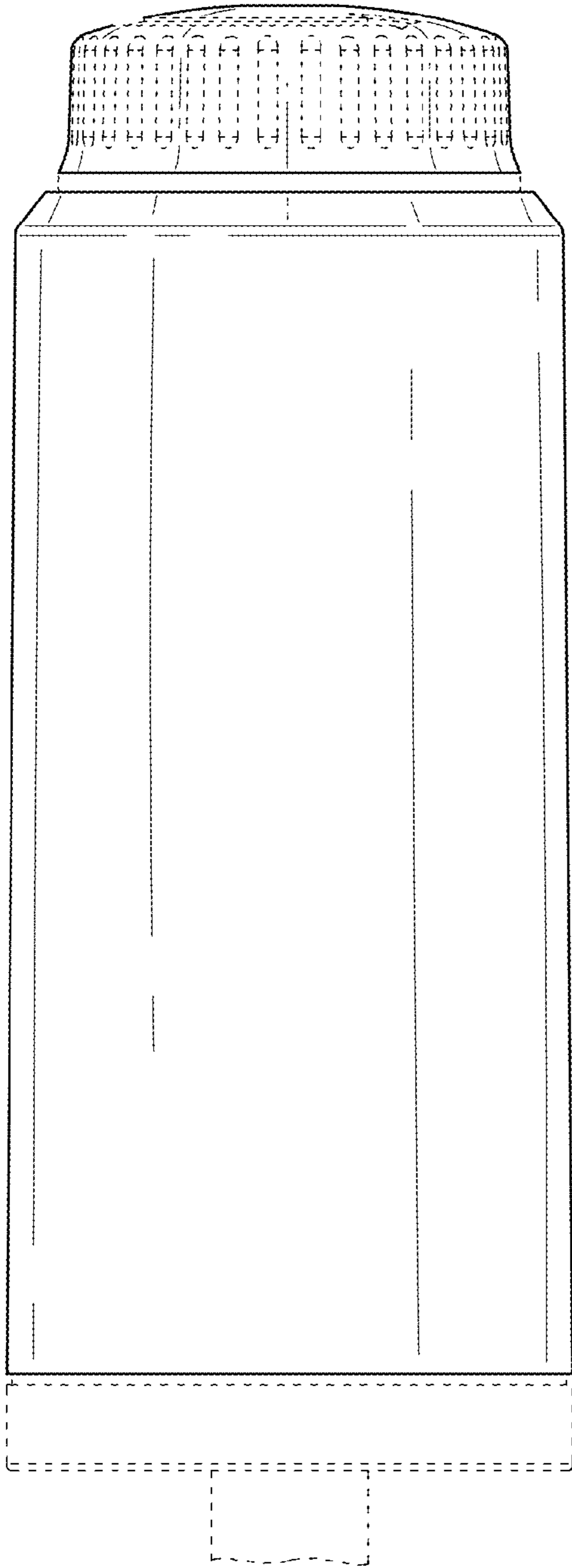

FIG. 23

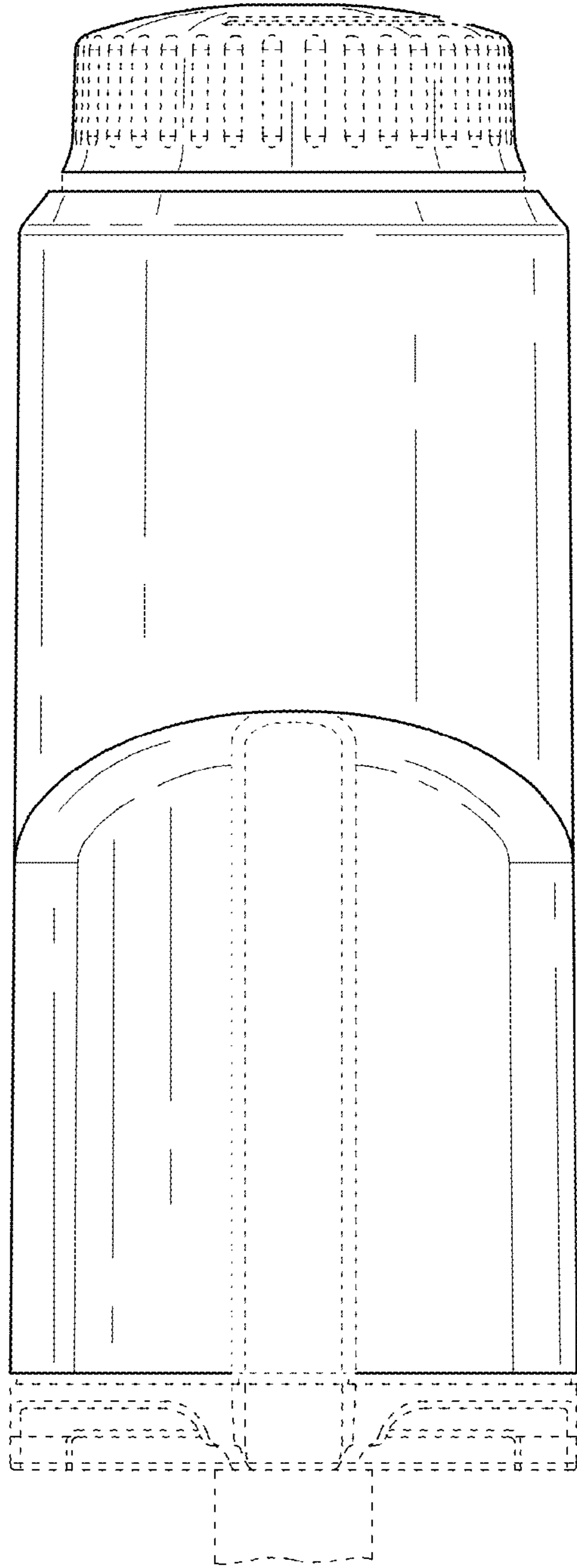

FIG. 24

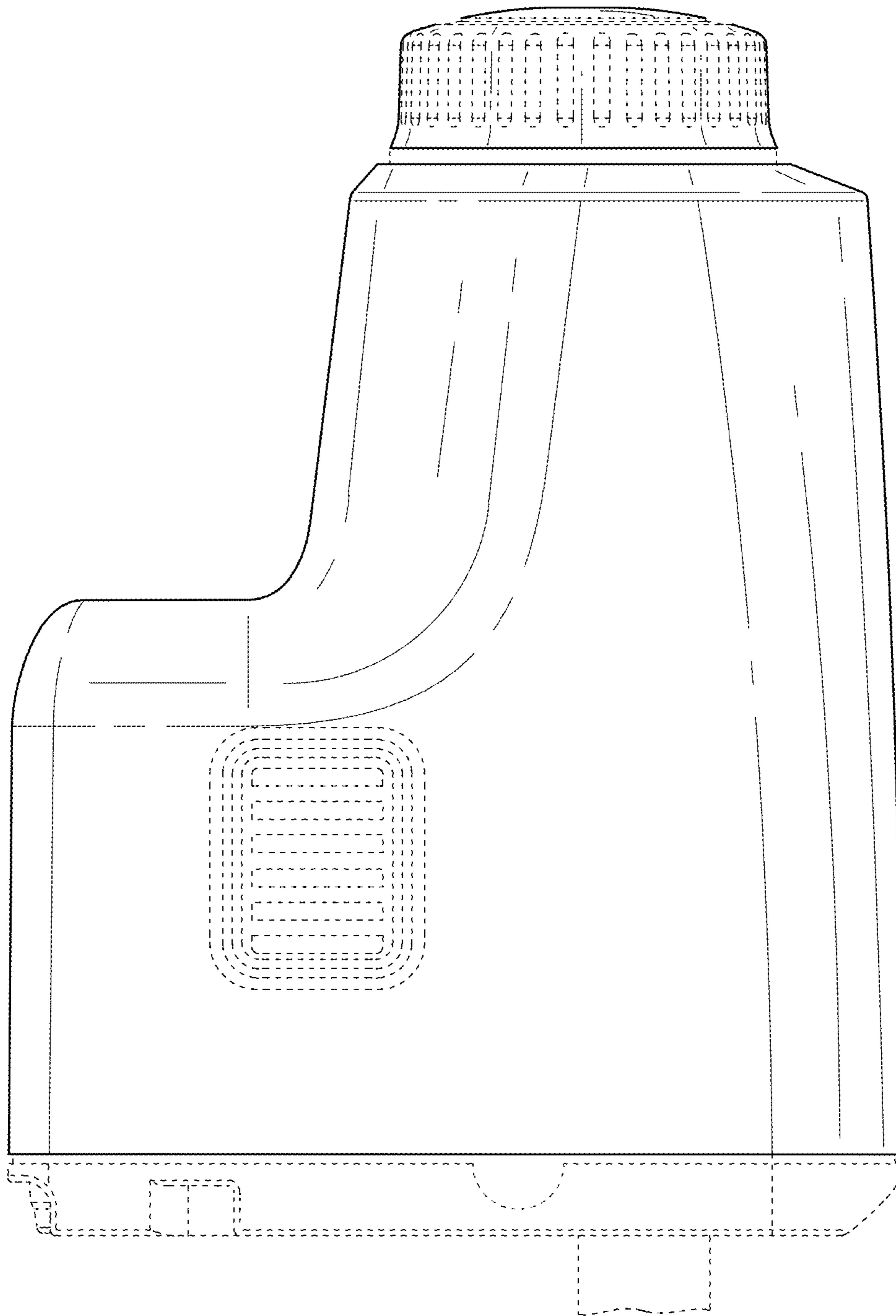

FIG. 25



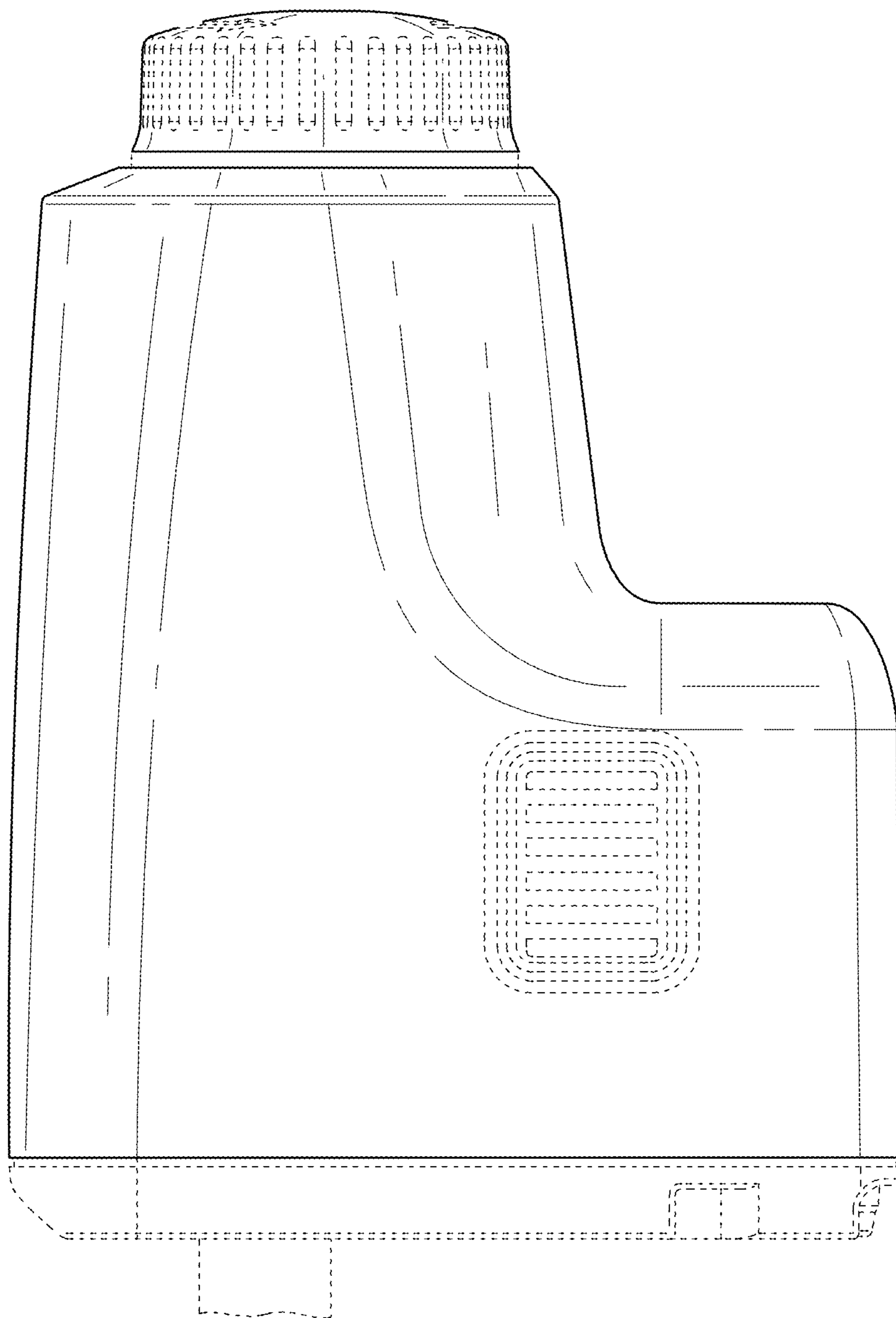

FIG. 26

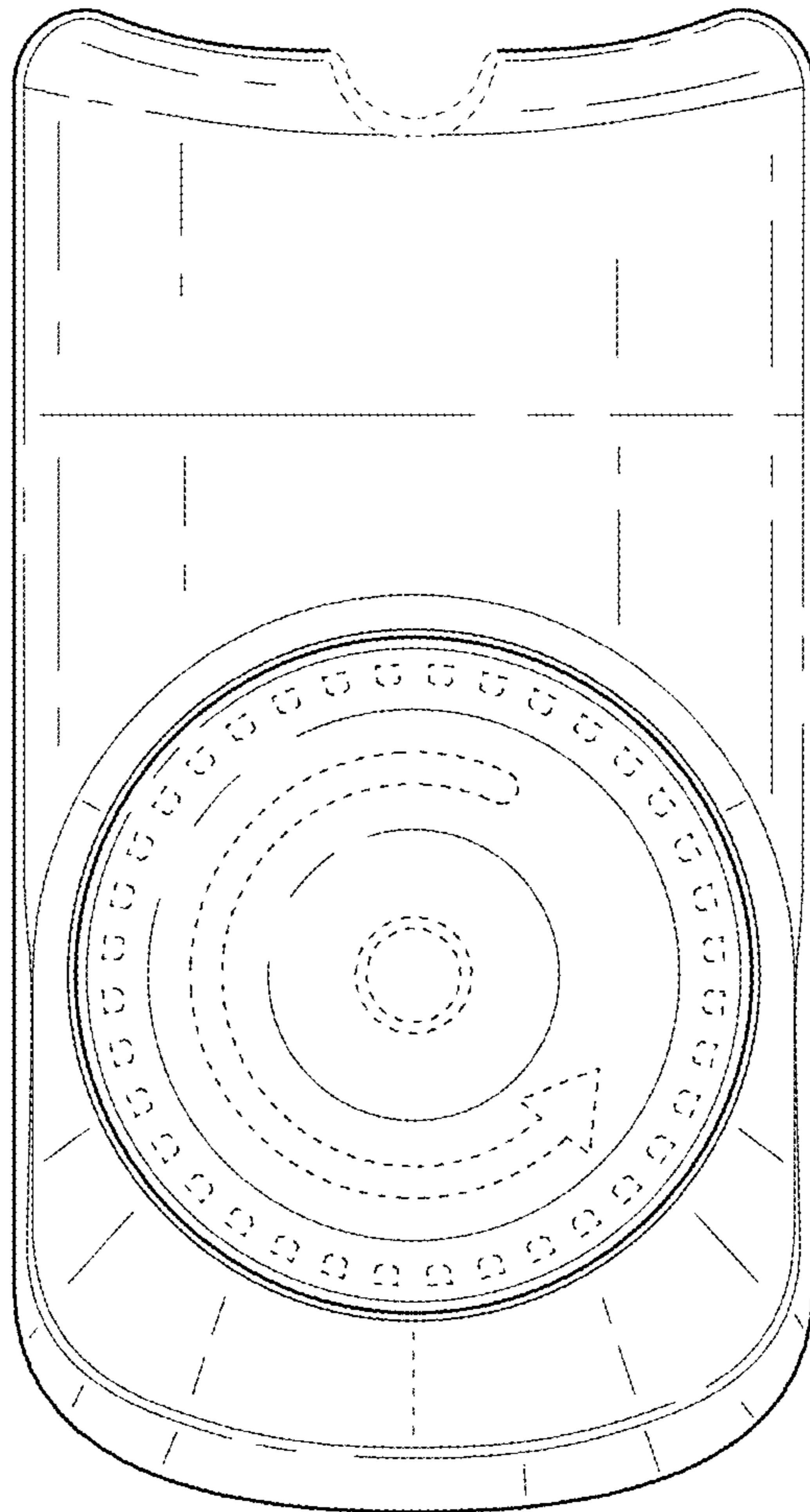

FIG. 27

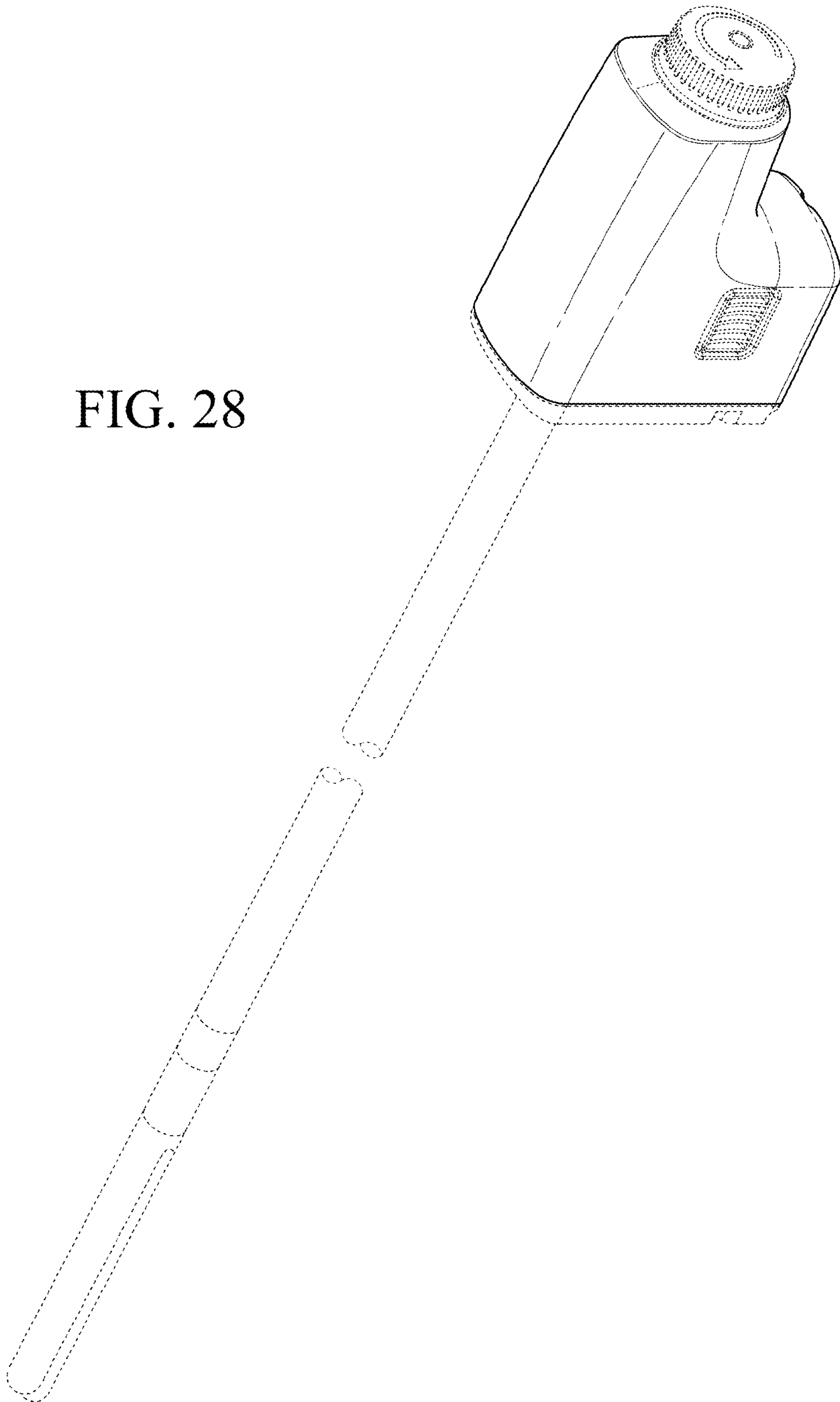

FIG. 28