



US00D884863S

(12) **United States Design Patent** (10) **Patent No.:** **US D884,863 S**
Semerak et al. (45) **Date of Patent:** **** May 19, 2020**

(54) **AIR PURIFIER**

(71) Applicant: **SENSE VITAL AIR, S.R.O.**, Prague (CZ)

(72) Inventors: **Karel Semerak**, Prague (CZ); **Kristyna Vachova**, Prague (CZ)

(73) Assignee: **SENSE VITAL AIR, S.R.O.**, Prague (CZ)

(**) Term: **15 Years**

(21) Appl. No.: **29/693,084**

(22) Filed: **May 30, 2019**

(30) **Foreign Application Priority Data**

Dec. 17, 2018 (EM) 005908688

(51) **LOC (12) Cl.** **23-04**

(52) **U.S. Cl.**
USPC **D23/364**

(58) **Field of Classification Search**
USPC D23/355–366, 352, 369, 332, 333, 335,
D23/336, 342, 351; 422/120, 122;
55/356, 473, 504; 96/97; 261/DIG. 17,
261/DIG. 65, DIG. 88, DIG. 31
CPC .. A61L 9/16; A61L 9/22; B01D 47/00; B01D
47/027; B01D 2221/02; B01D 2259/4508;
B03C 3/155; B03C 3/368; F24F 3/16;
F24F 13/20; F24F 13/28; F24F
2001/0096
See application file for complete search history.

(56) **References Cited**

U.S. PATENT DOCUMENTS

D634,417 S * 3/2011 Abbondanzio D23/366
D835,766 S * 12/2018 Chen D23/364

D836,760 S * 12/2018 Fredang D23/364
D844,767 S * 4/2019 Chen D23/364
D845,456 S * 4/2019 Swanson D23/359
D857,871 S * 8/2019 Shah D23/366
D865,149 S * 10/2019 Lin D23/364
D870,870 S * 12/2019 Copparstad D23/351
D873,401 S * 1/2020 Chen D23/364
D874,623 S * 2/2020 Lupi D23/333
D877,874 S * 3/2020 Liu D23/364
D878,528 S * 3/2020 Fu D23/356
D878,529 S * 3/2020 Zhong D23/364

* cited by examiner

Primary Examiner — David G Muller

(74) *Attorney, Agent, or Firm* — Notaro, Michalos & Zaccaria P.C.

(57) **CLAIM**

The ornamental design for an air purifier, as shown and described.

DESCRIPTION

FIG. 1 is a top, front, right perspective view of an air purifier showing our design therefor;
FIG. 2 is a bottom, right, rear perspective view thereof;
FIG. 3 top plan view thereof;
FIG. 4 is a rear elevational view thereof;
FIG. 5 is a left side elevational view thereof;
FIG. 6 is a front elevational view thereof;
FIG. 7 is a bottom plan view thereof;
FIG. 8 is a right side elevational view thereof; and,
FIG. 9 is a top, rear, left perspective view thereof.

1 Claim, 9 Drawing Sheets

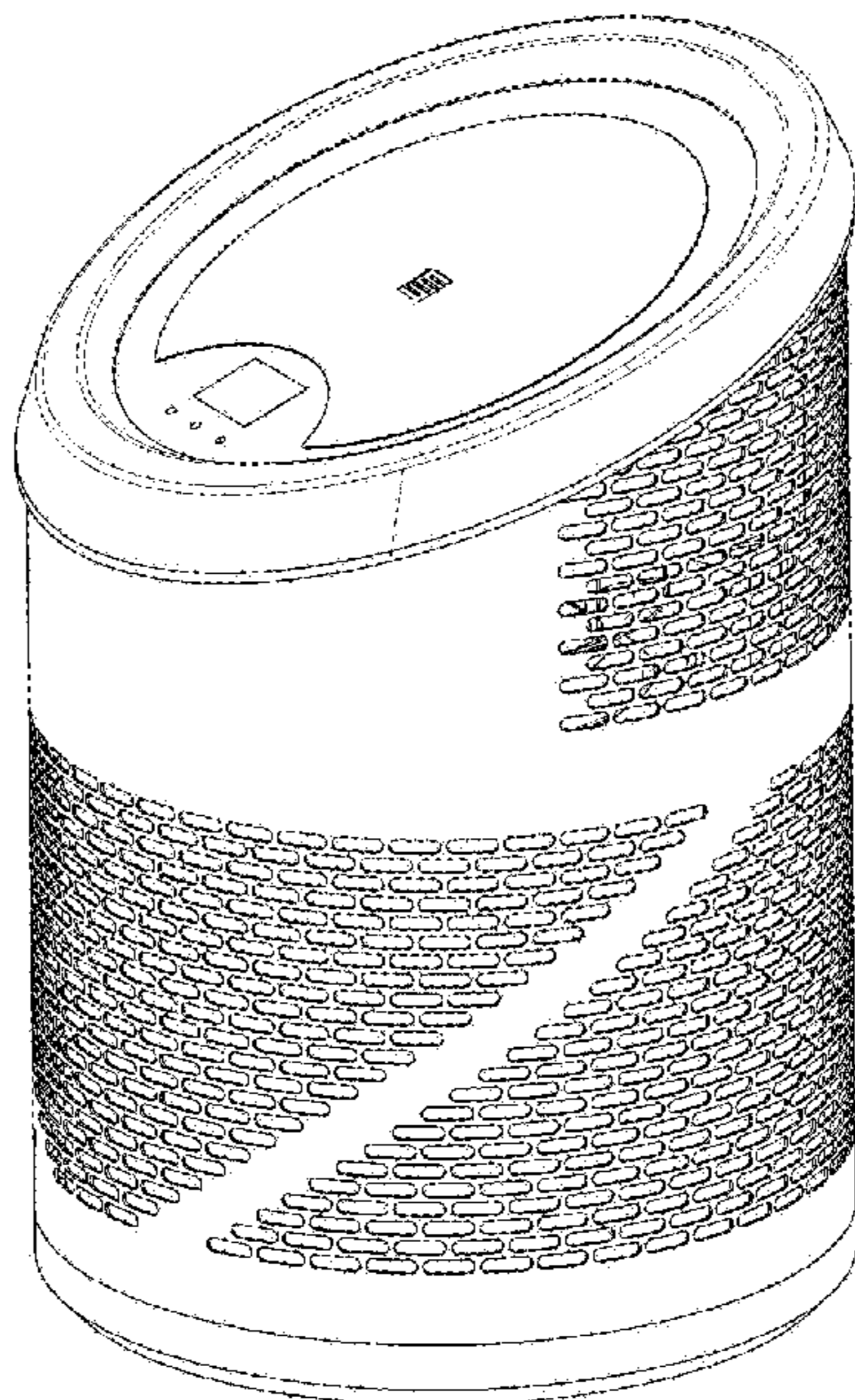

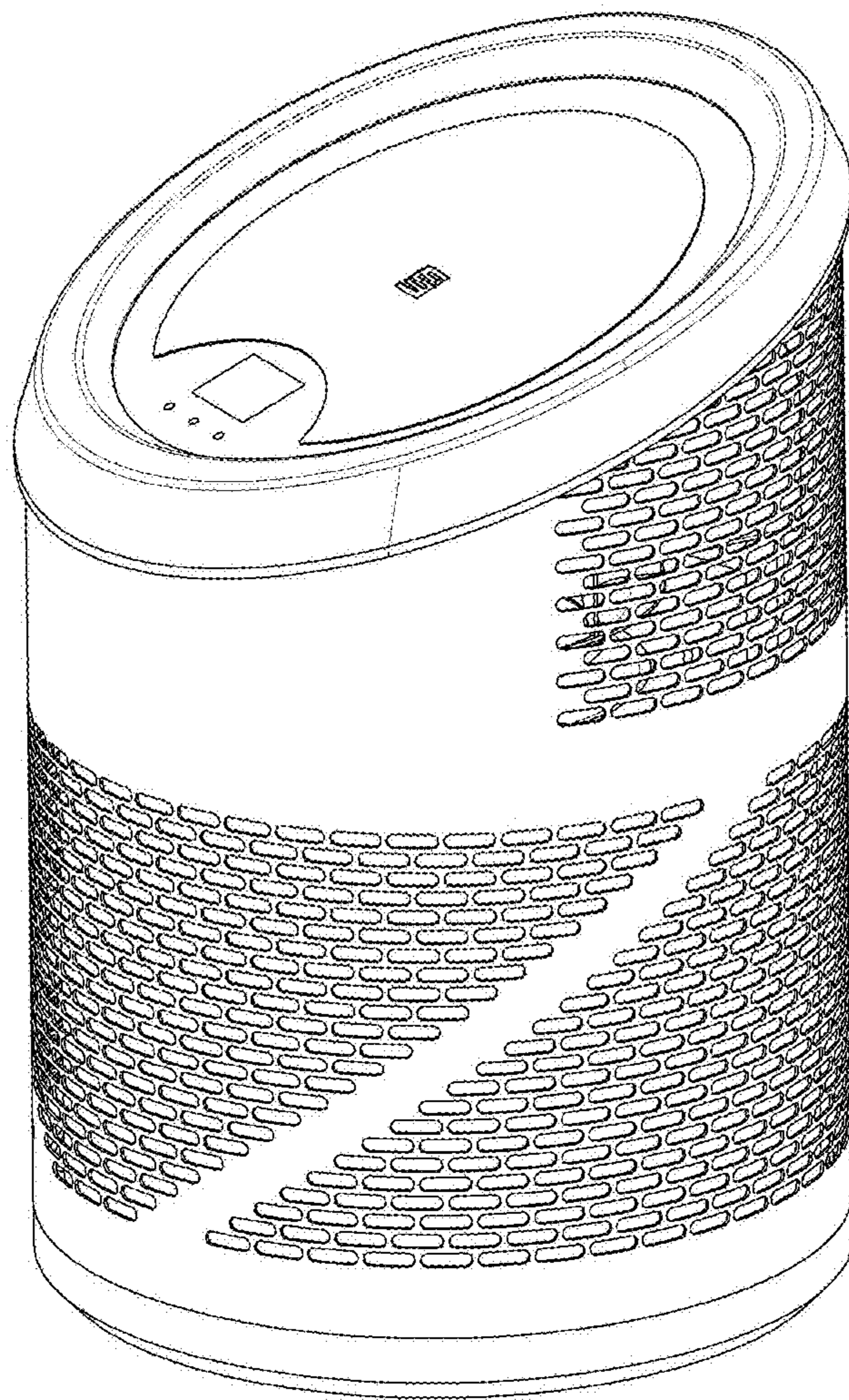

FIG. 1

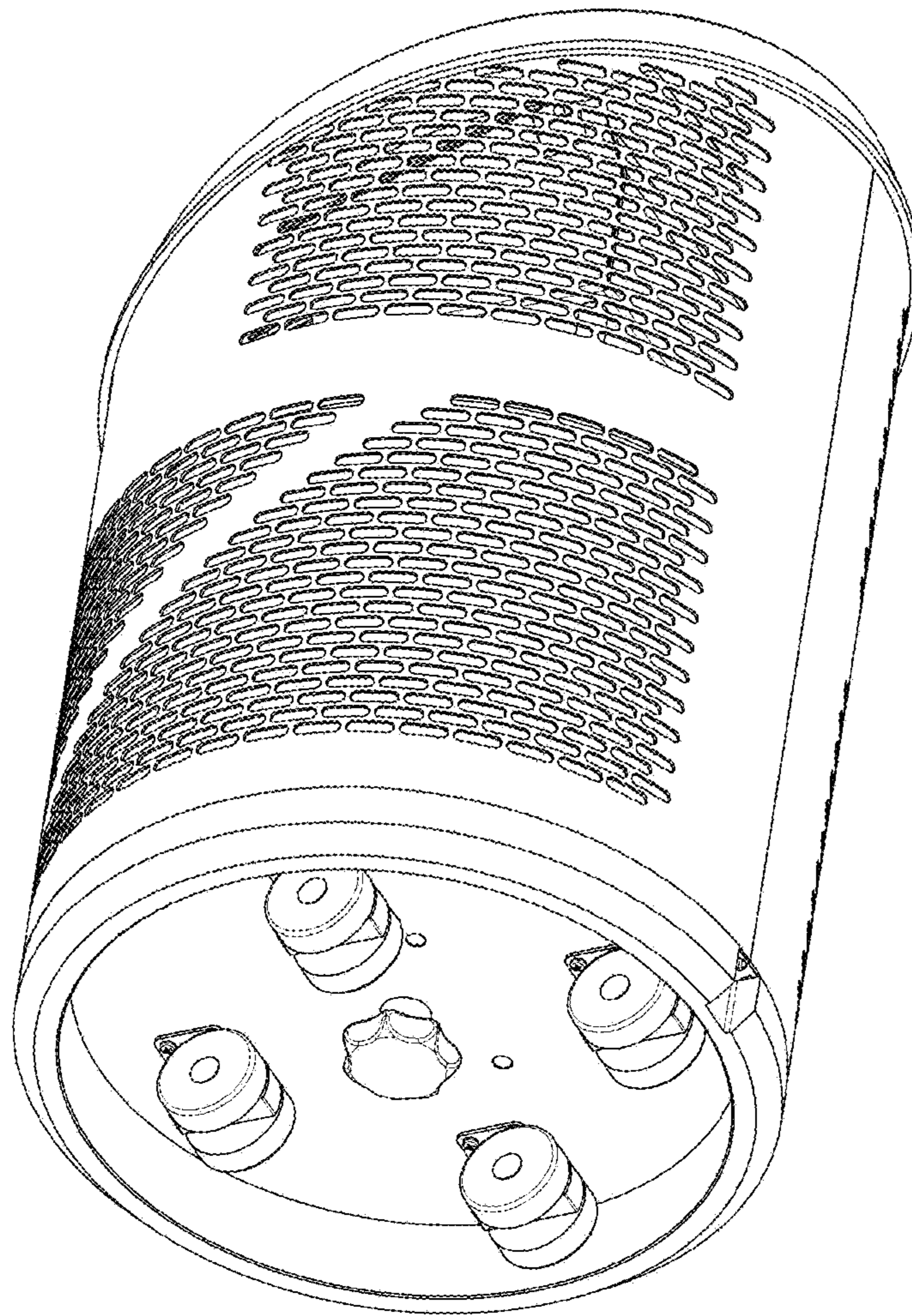

FIG. 2

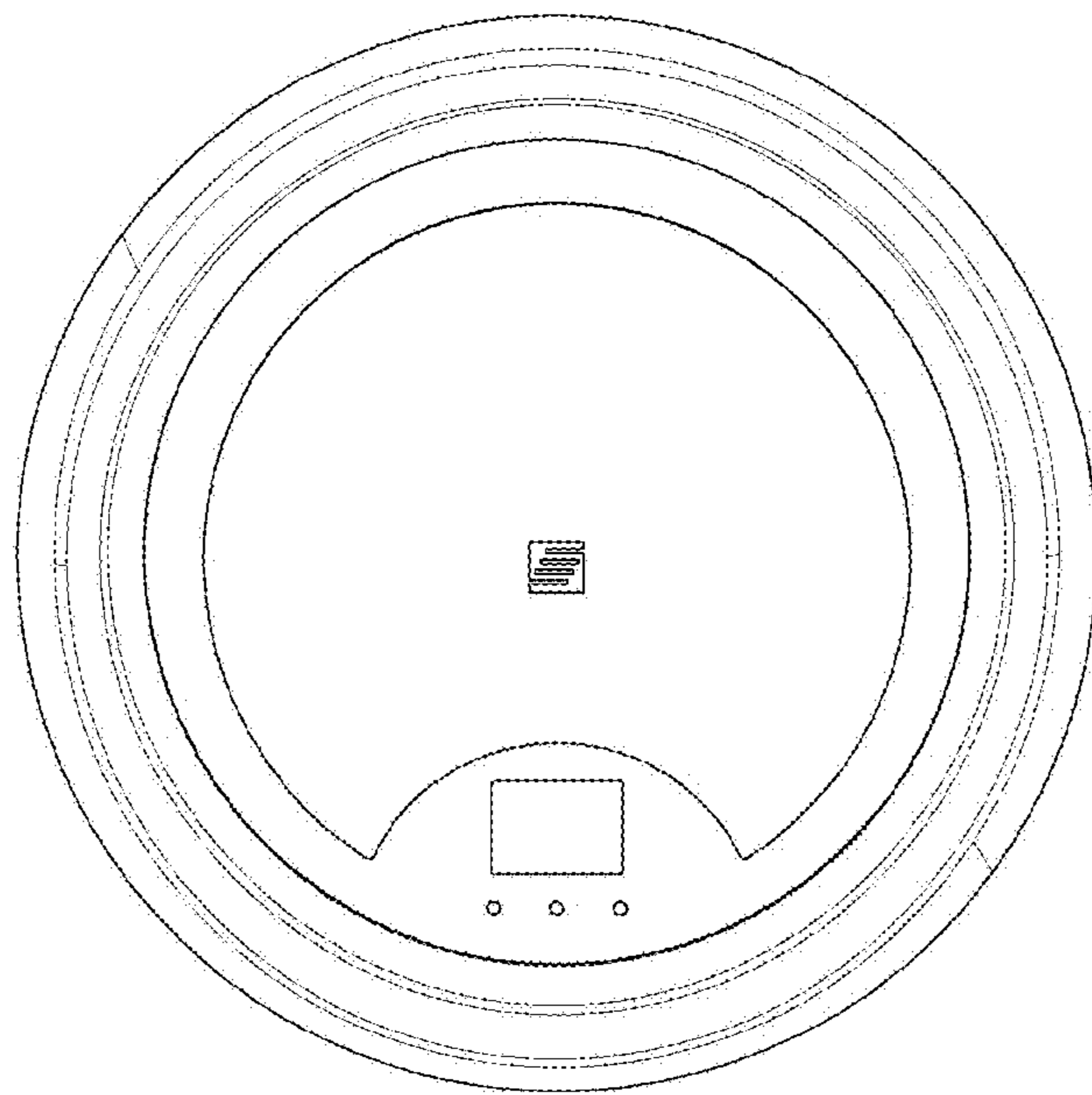

FIG. 3

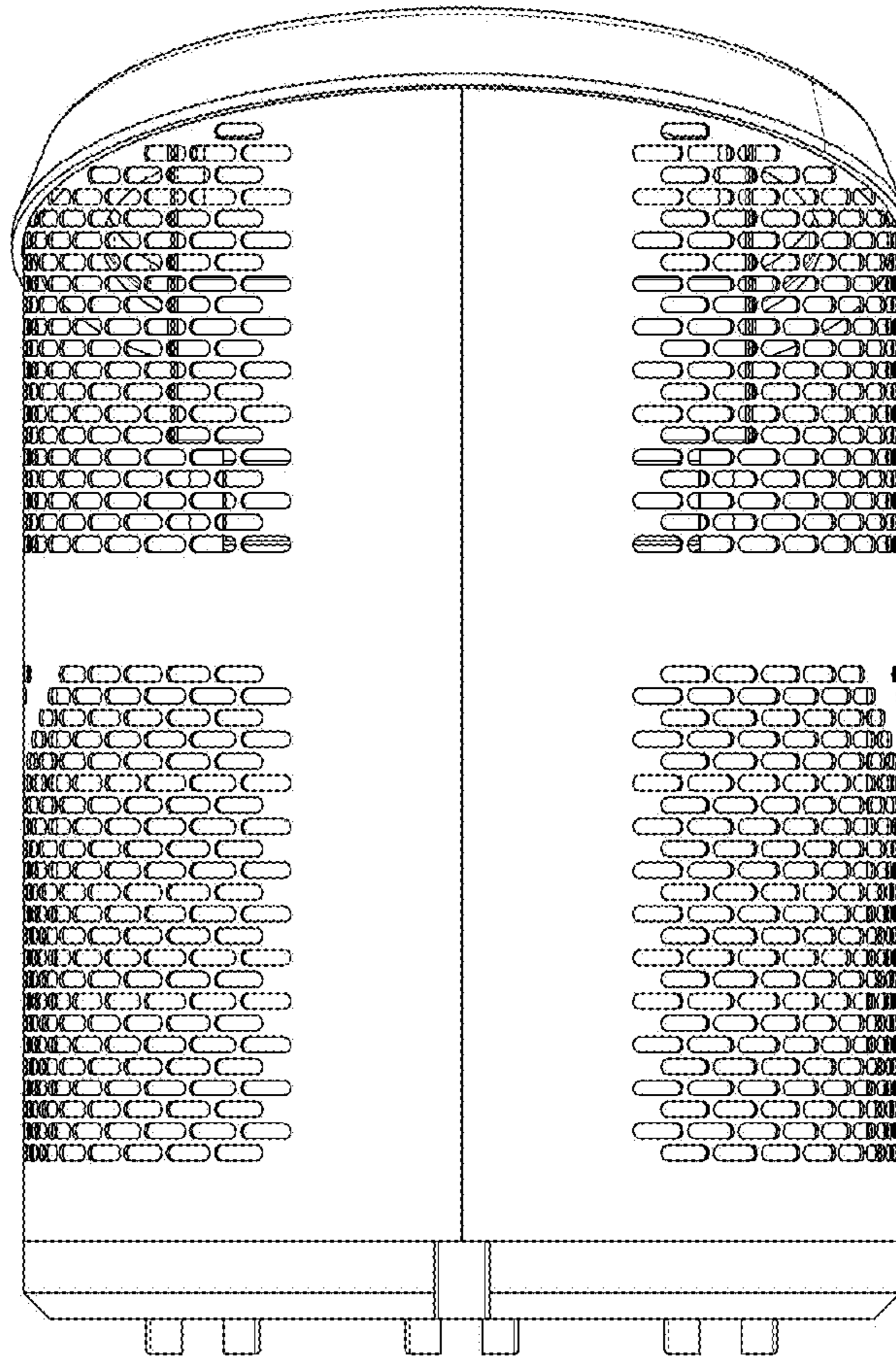

FIG. 4

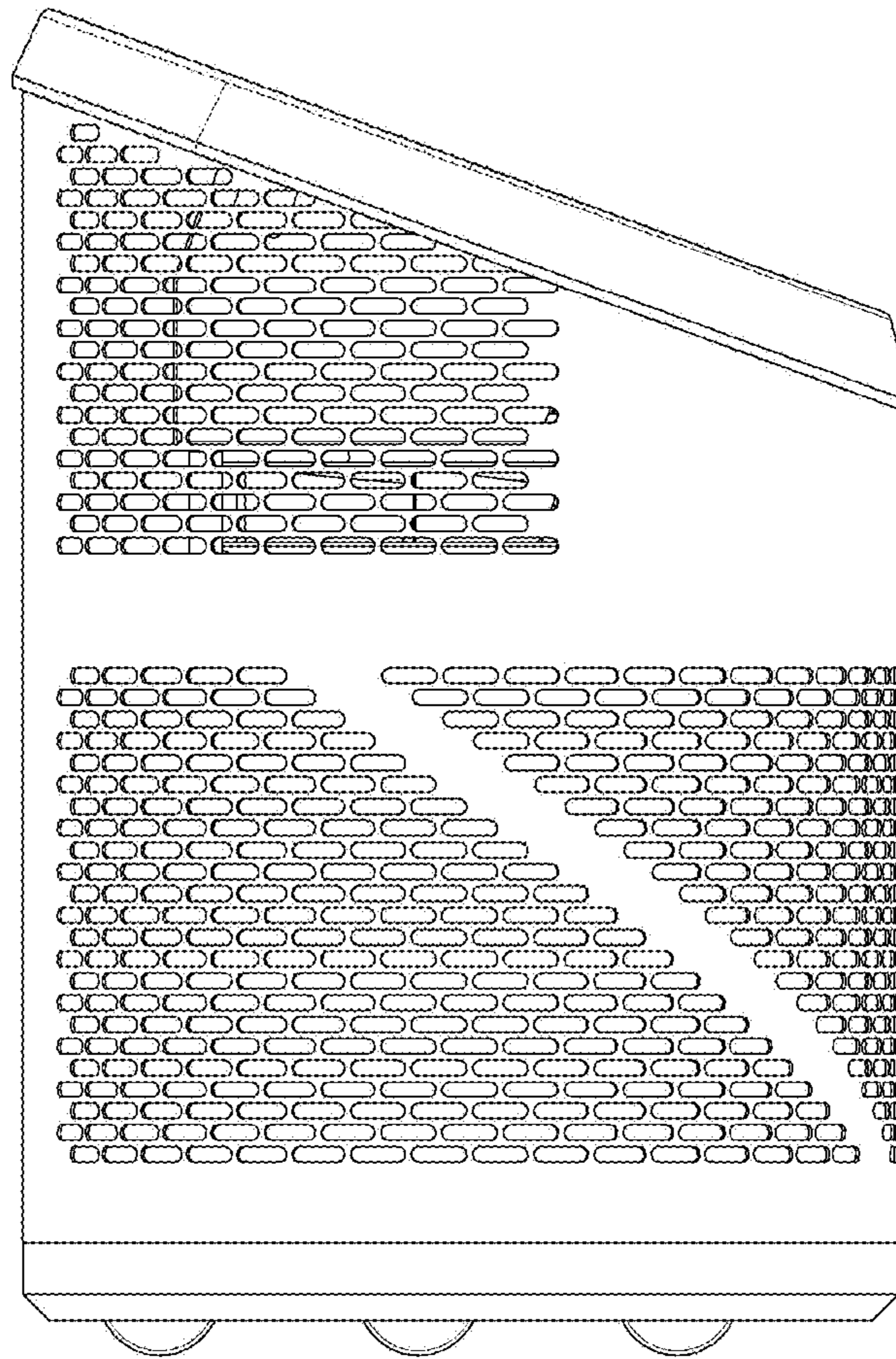

FIG. 5

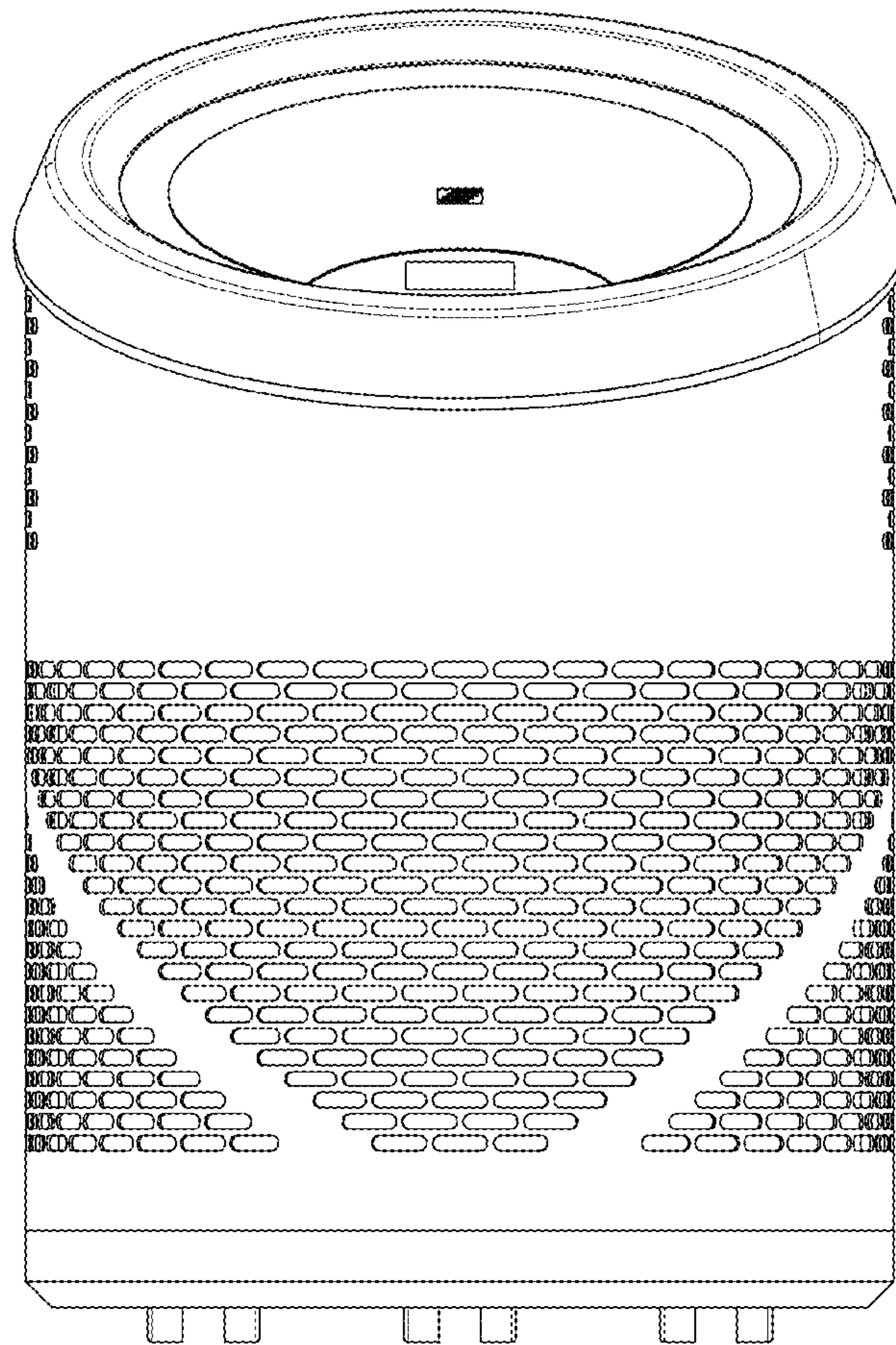

FIG. 6

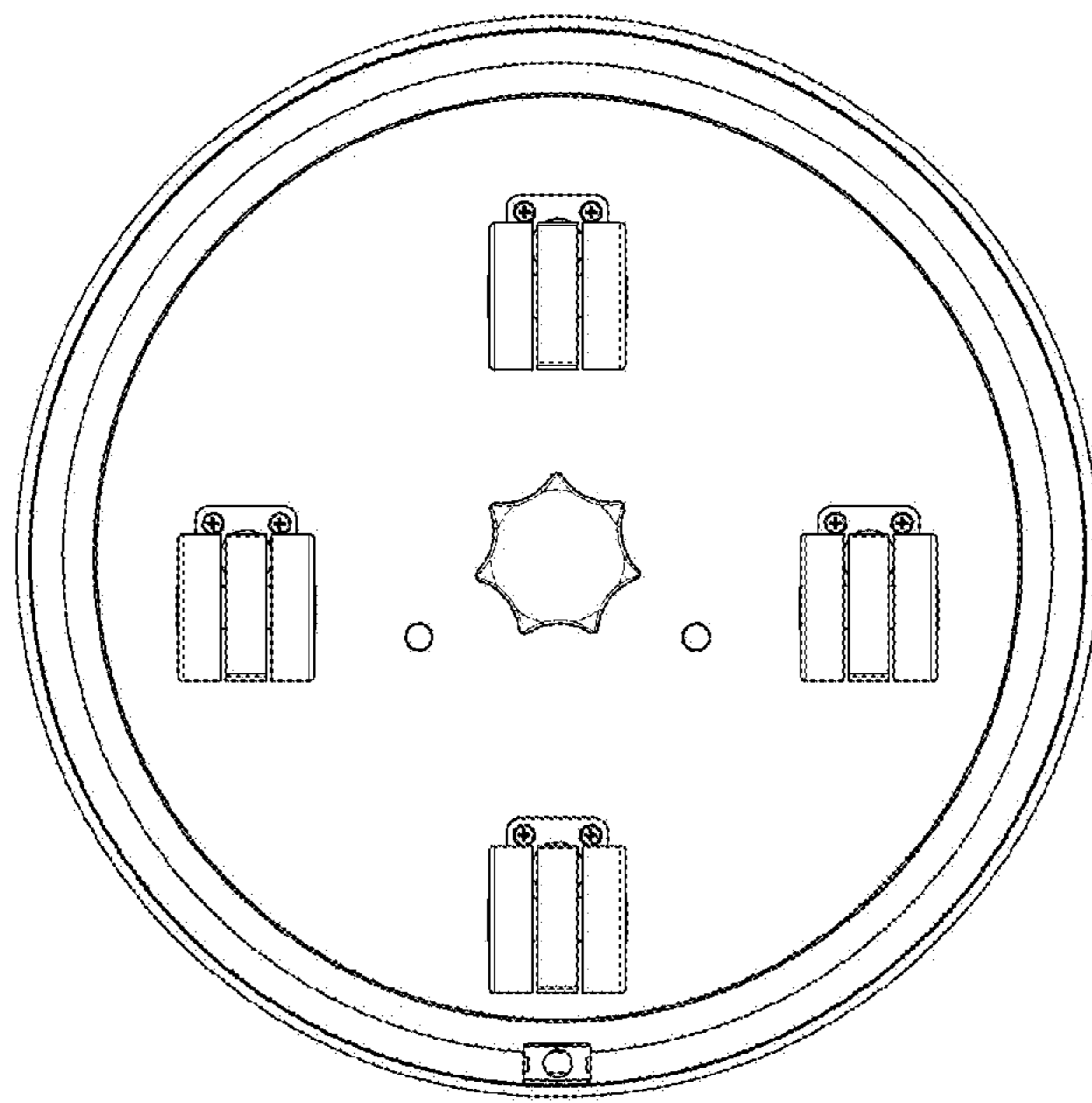

FIG. 7

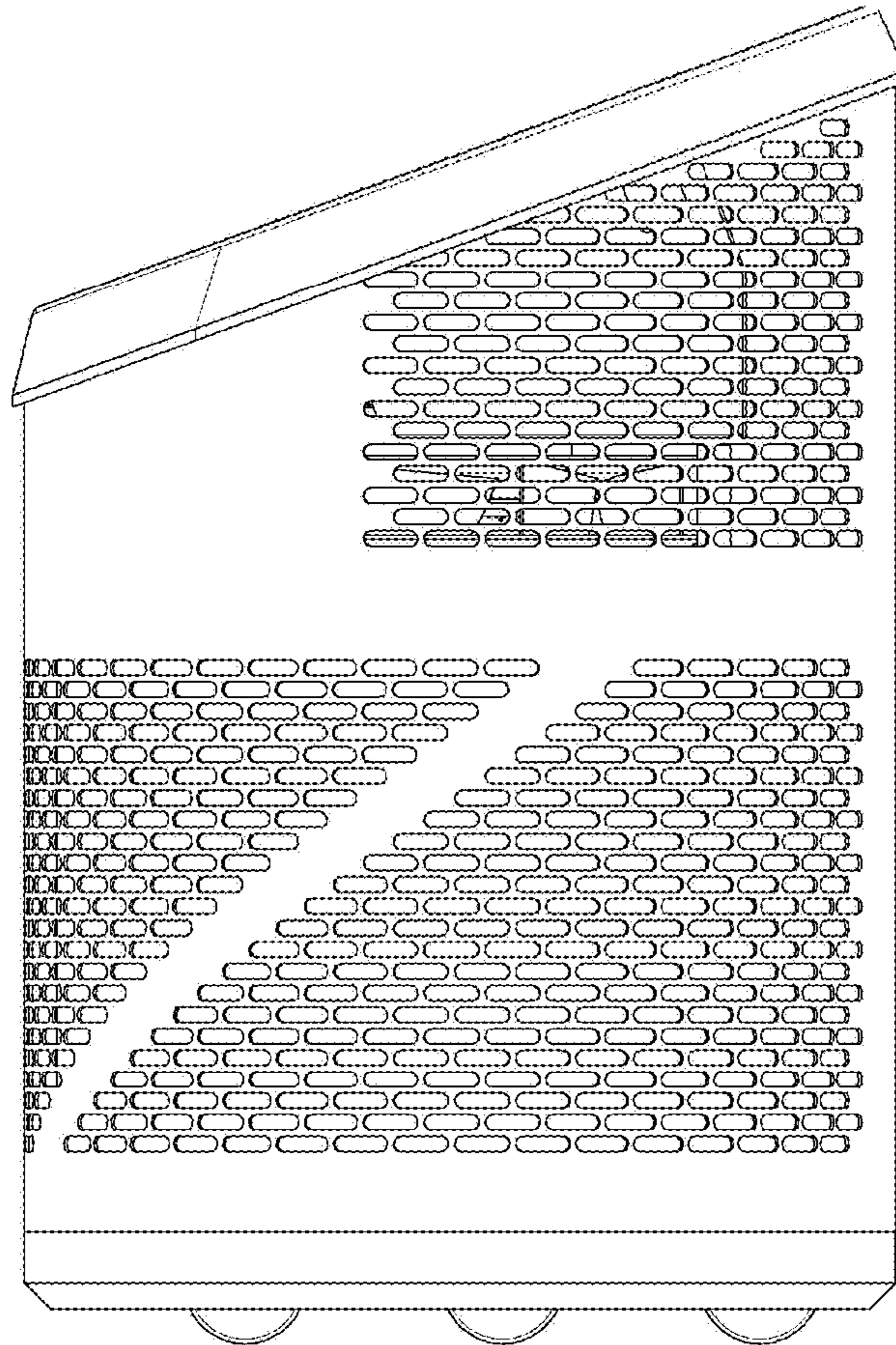

FIG. 8

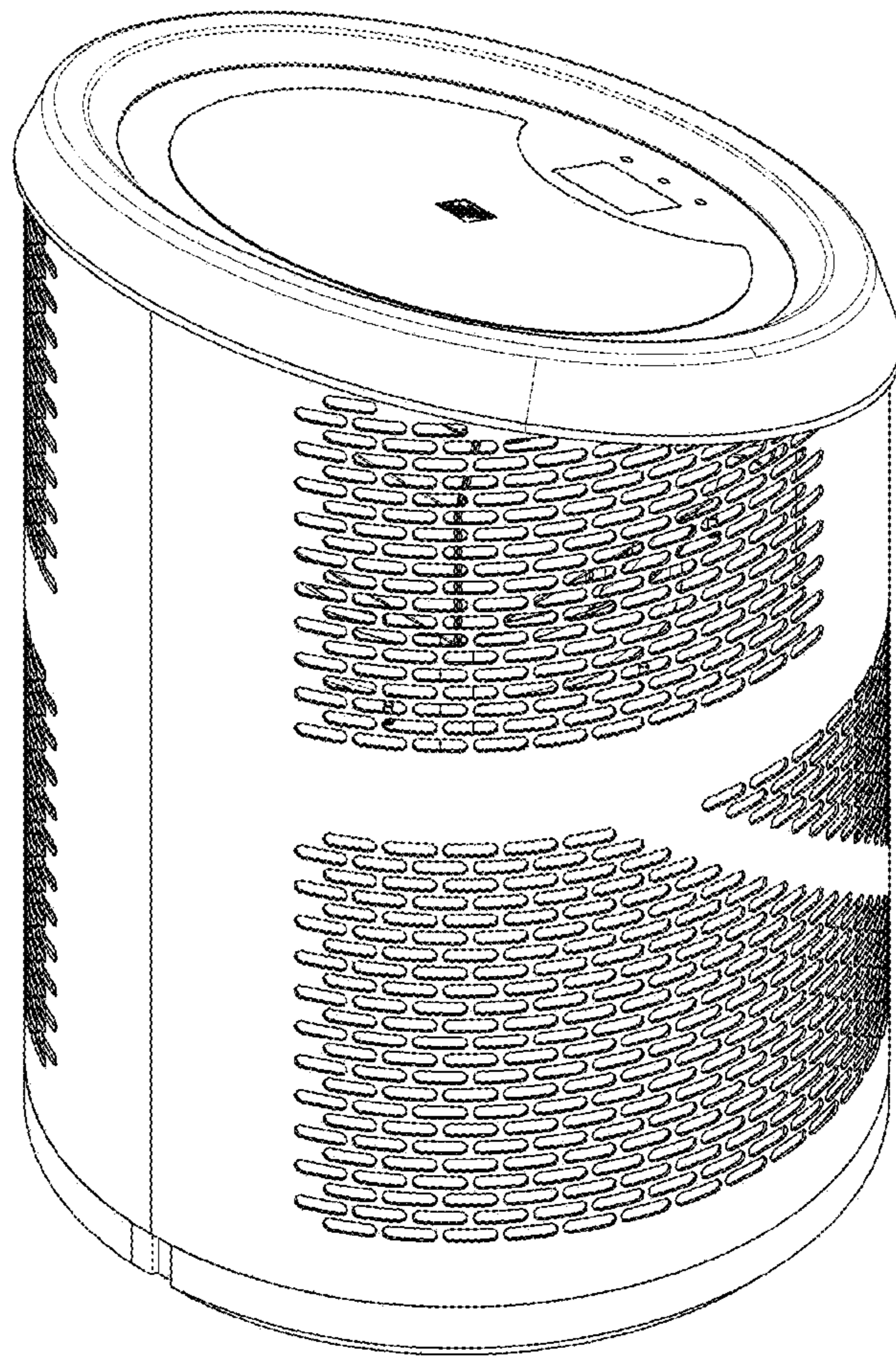

FIG. 9