



US00D884825S

(12) **United States Design Patent** (10) **Patent No.:** **US D884,825 S**
Rose (45) **Date of Patent:** **** May 19, 2020**

(54) **KEEL-WEIGHTED FISHING LURE HEAD**

D725,225 S * 3/2015 Altmann D22/126
D764,013 S * 8/2016 Solberg D22/126
2008/0155883 A1* 7/2008 Corbitt A01K 85/00
43/42.28

(71) Applicant: **David Rose**, Greenville, NC (US)

(72) Inventor: **David Rose**, Greenville, NC (US)

(**) Term: **15 Years**

(21) Appl. No.: **29/685,695**

(22) Filed: **Mar. 29, 2019**

(51) **LOC (12) Cl.** **22-05**

(52) **U.S. Cl.**
USPC **D22/129; D22/126**

(58) **Field of Classification Search**
USPC D22/126-133; 43/42.14, 42.28, 42.34,
43/42.37, 42.39, 42.35, 42.09
CPC A01K 85/00; A01K 85/01; A01K 85/02;
A01K 85/08
See application file for complete search history.

* cited by examiner

Primary Examiner — Catherine R Oliver-Garcia
(74) *Attorney, Agent, or Firm* — Johan Eide; Christopher Pilling; My Patent Guys

(57) **CLAIM**

An ornamental design for a keel-weighted fishing lure head, as shown and described.

DESCRIPTION

FIG. 1 is a front and side perspective view of a keel-weighted fishing lure head showing the new design; FIG. 2 is a rear and opposite side perspective view thereof, showing the inside cavity wherein the head of a baitfish is inserted; FIG. 3 is a right side elevation view thereof; FIG. 4 is a left side elevation view thereof; FIG. 5 is a top plan view thereof; FIG. 6 is a bottom plan view thereof; FIG. 7 is a rear elevation view thereof; and, FIG. 8 is a front elevation view thereof. The solid line showing illustrates the claimed features within the design for the claimed article of manufacture. The shading is provided to illustrate contour and material type only and is not an indication of texture, gloss, etc.

(56) **References Cited**

U.S. PATENT DOCUMENTS

2,278,876 A * 4/1942 Hart A01K 85/08
43/42.09
D191,113 S * 8/1961 Hudson, Jr. D22/129
3,169,336 A * 2/1965 Pope A01K 85/00
43/42.28
3,497,987 A * 3/1970 Perrin A01K 85/00
43/42.28
D249,537 S * 9/1978 Parker D22/128
4,907,364 A * 3/1990 Hedman A01K 85/00
43/42.39
D425,167 S * 5/2000 Nelson D22/126

1 Claim, 7 Drawing Sheets

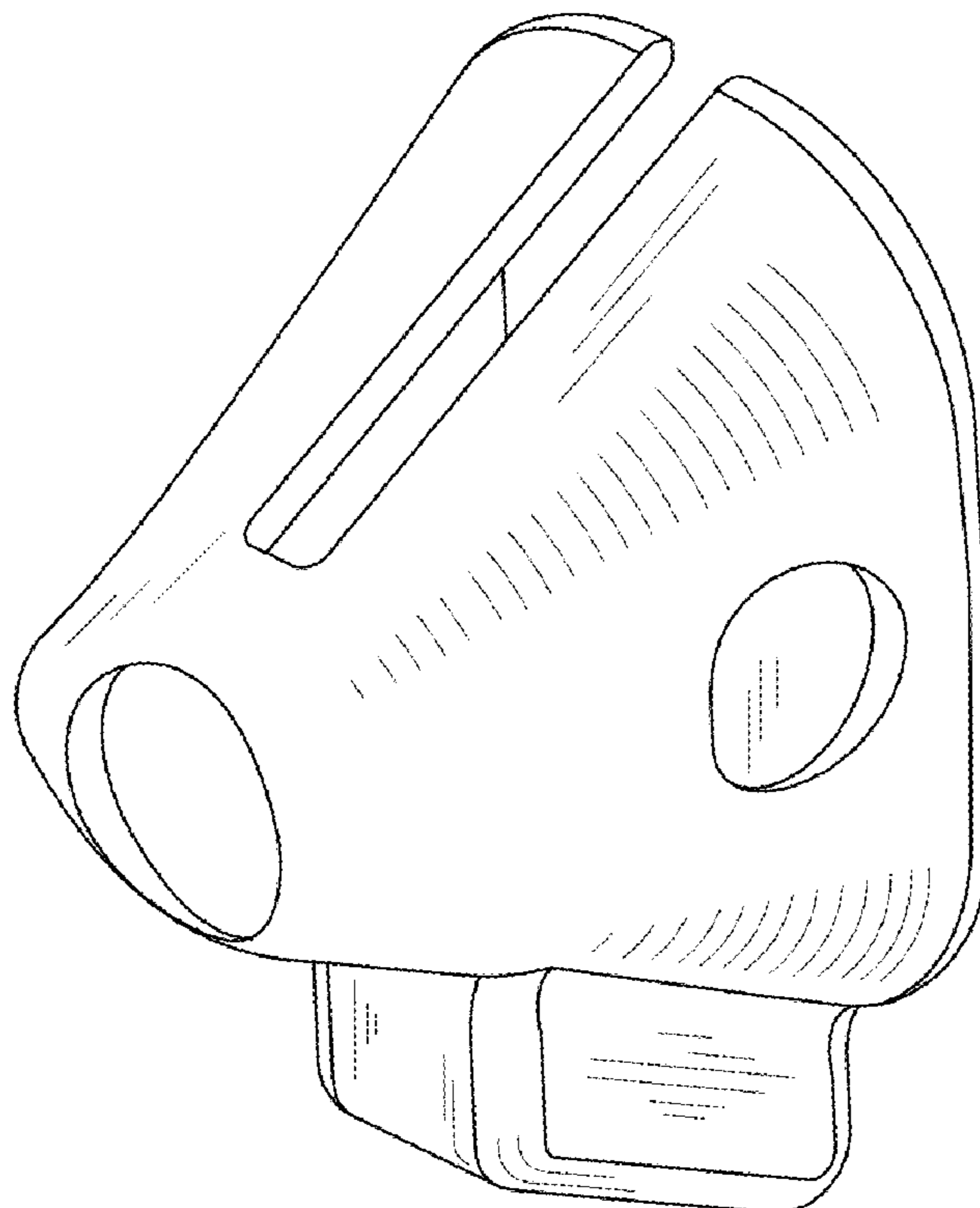

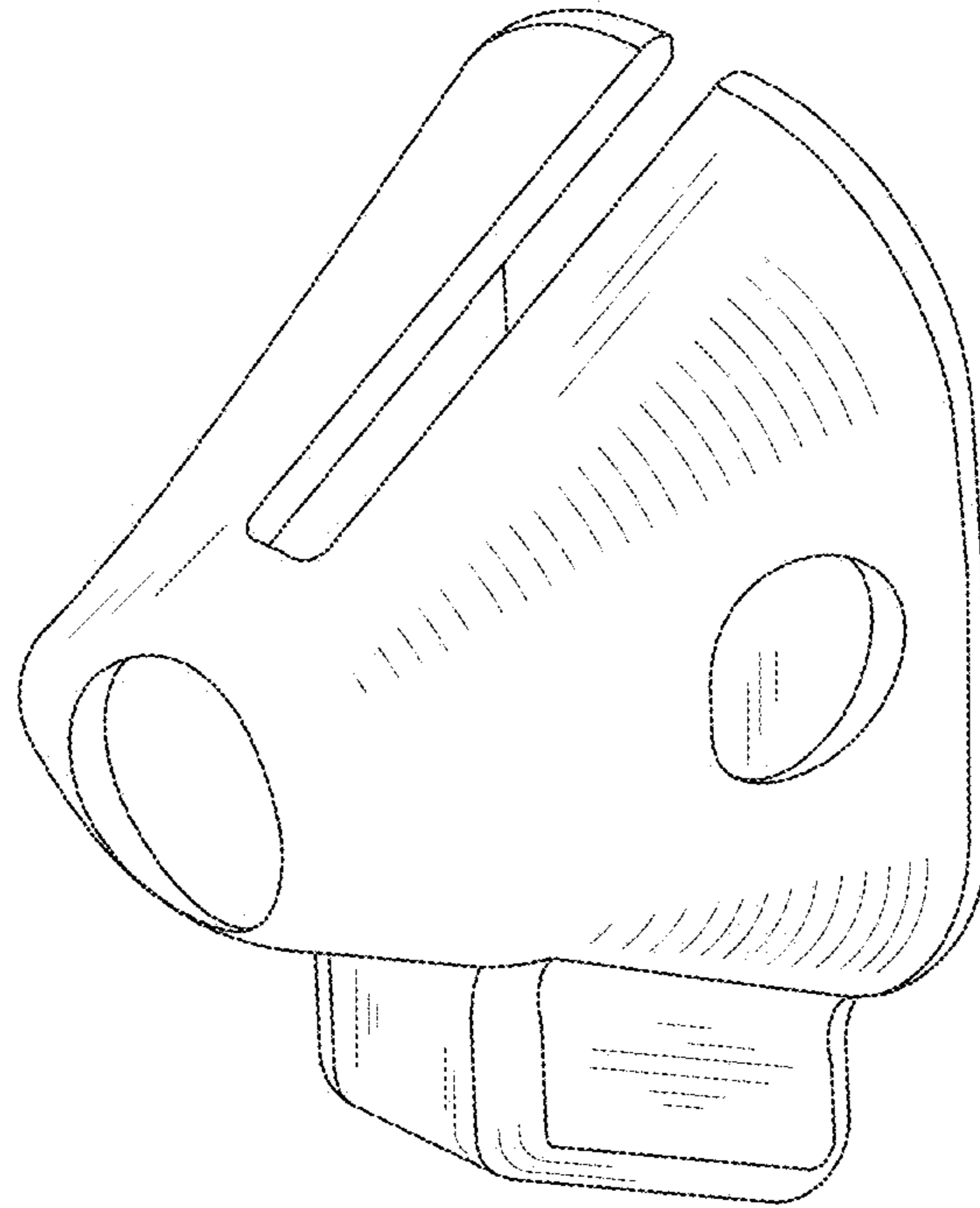

FIG. 1

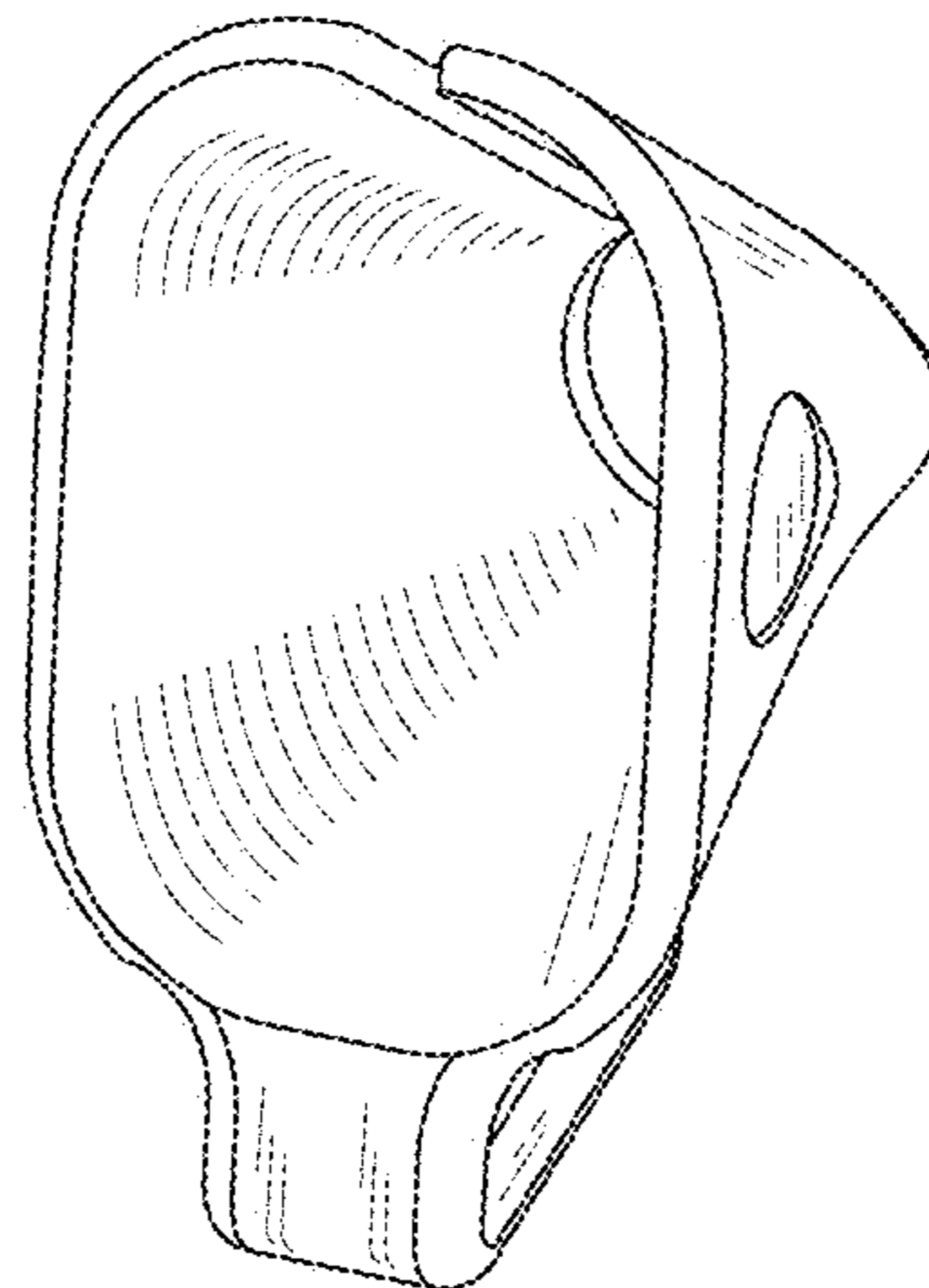

FIG. 2

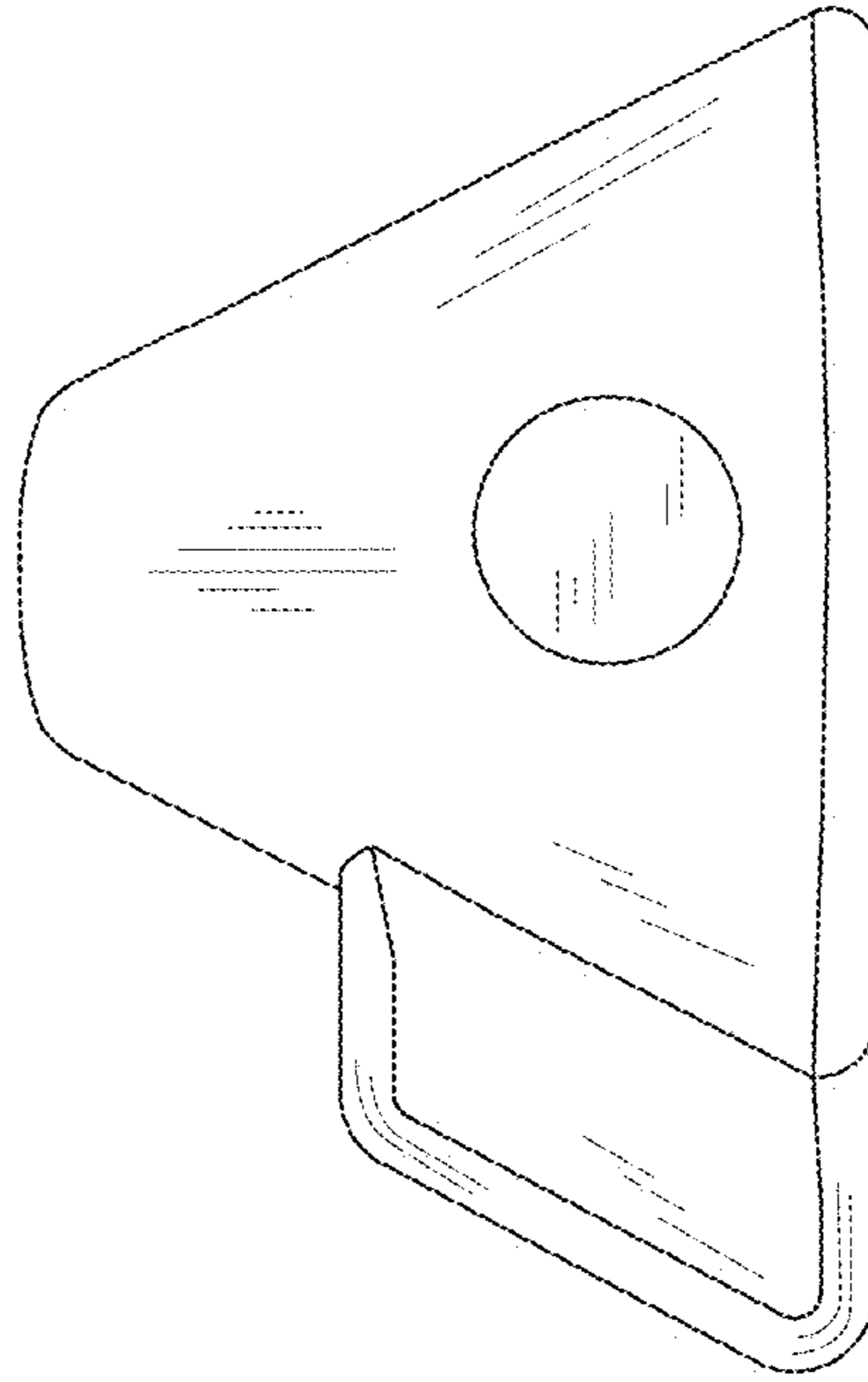

FIG. 3

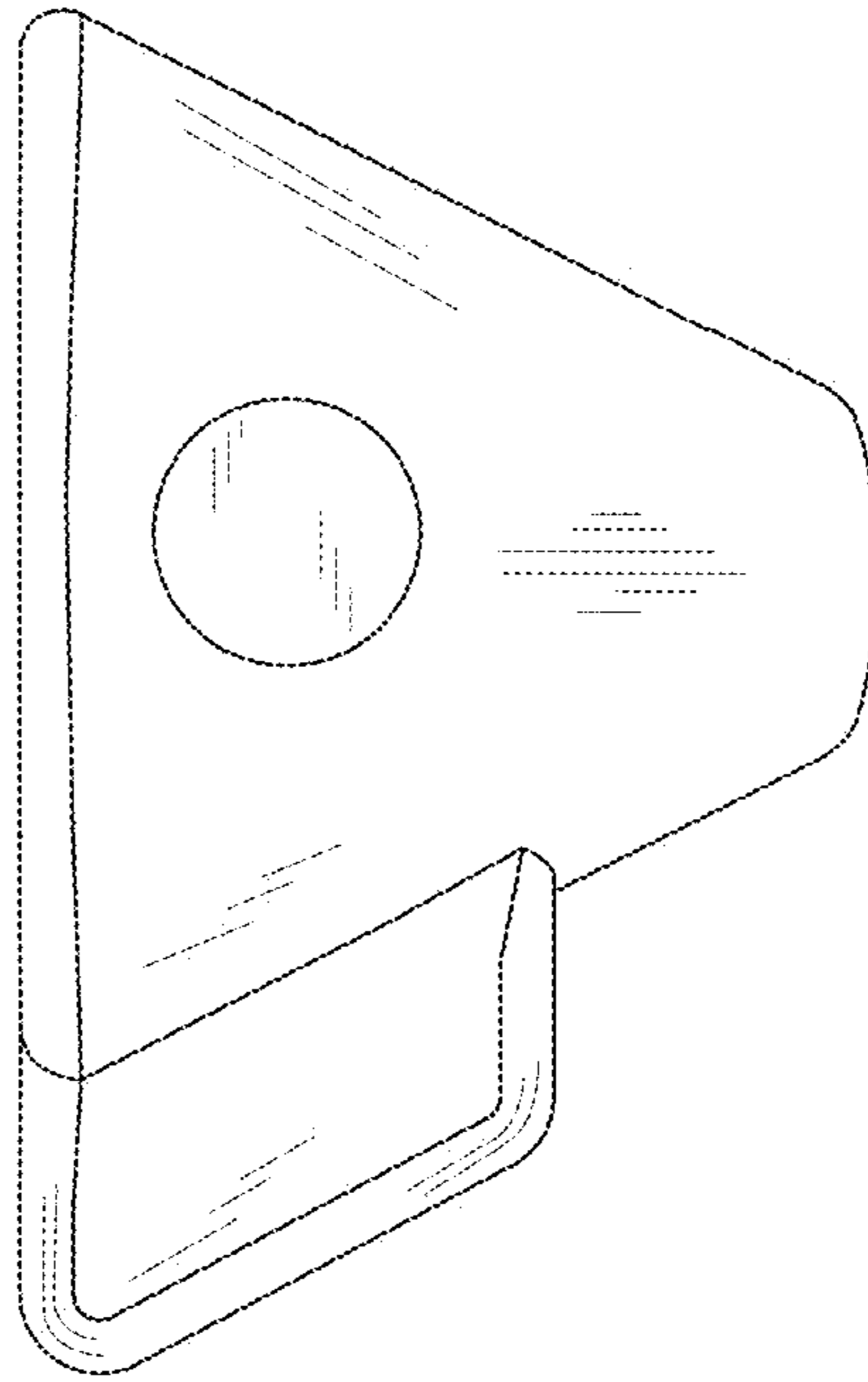

FIG. 4

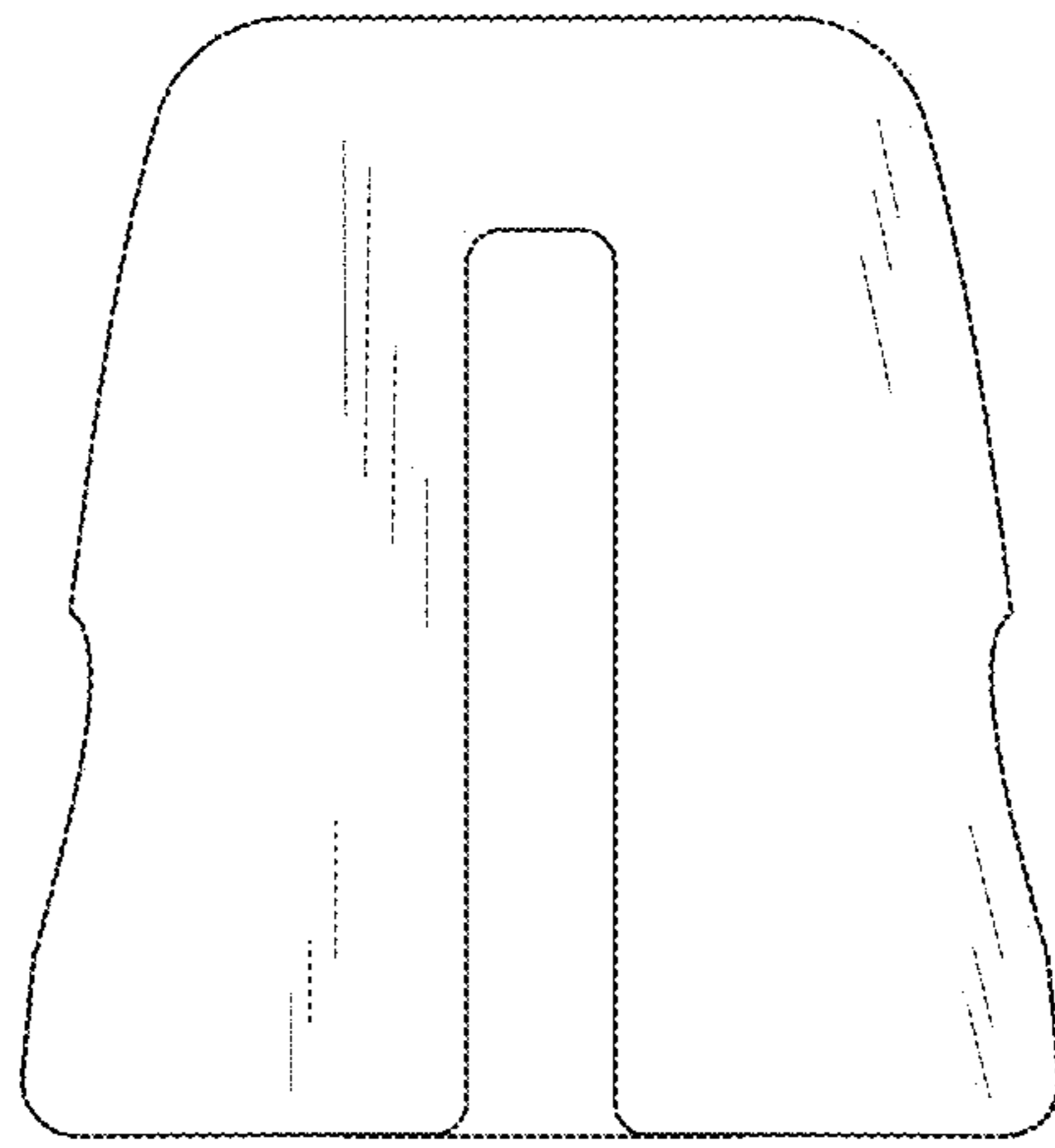

FIG. 5

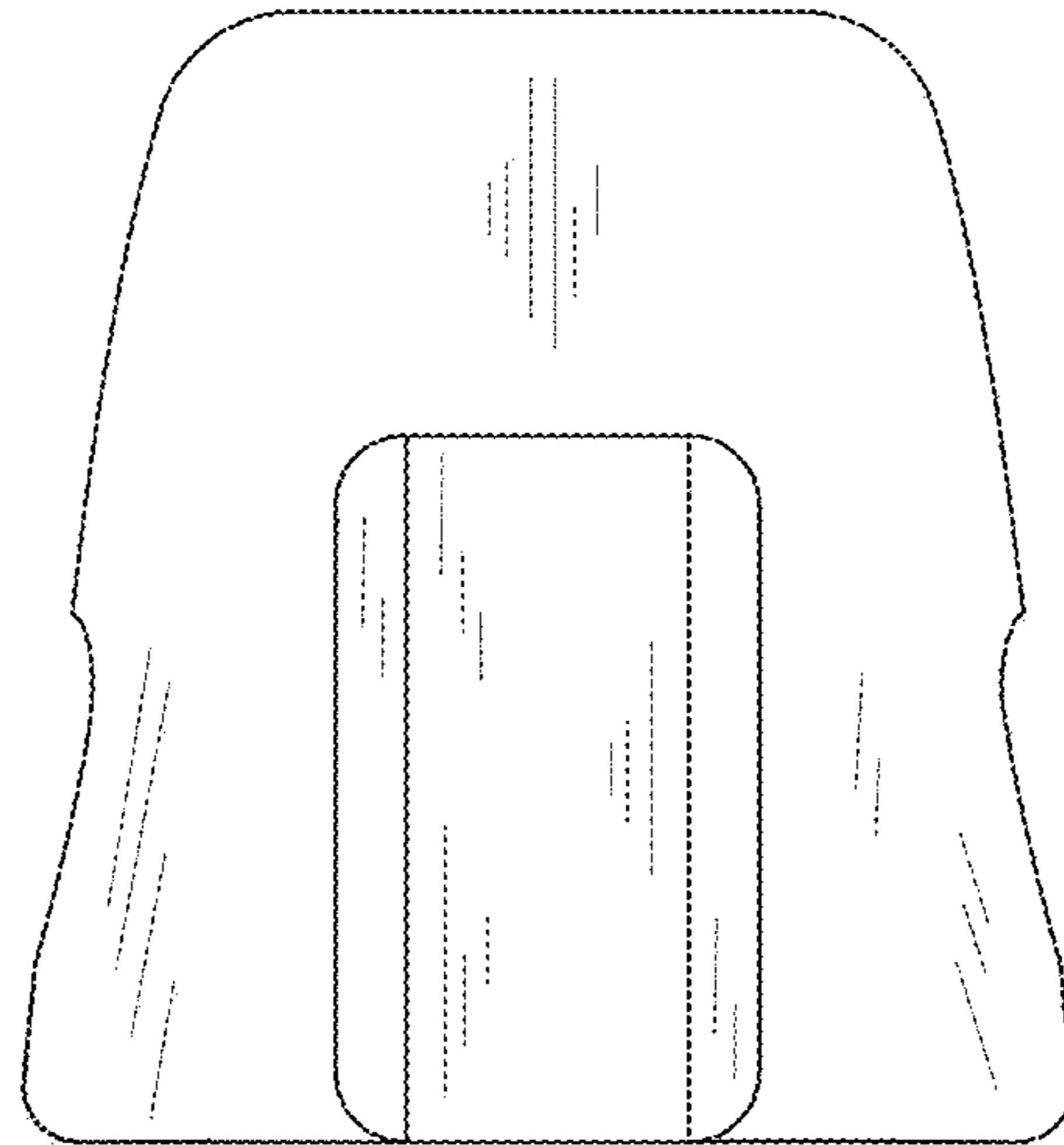

FIG. 6

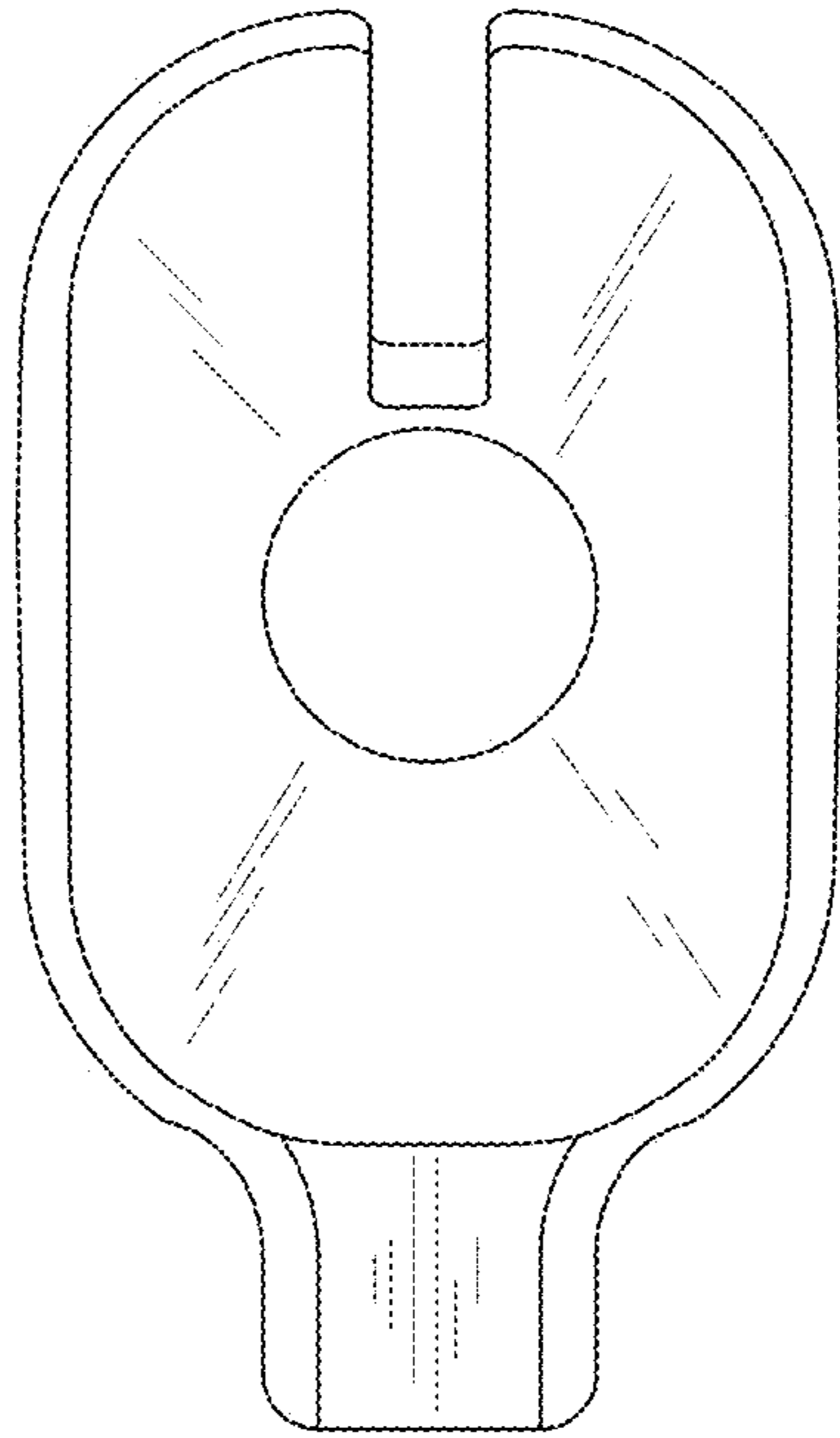

FIG. 7

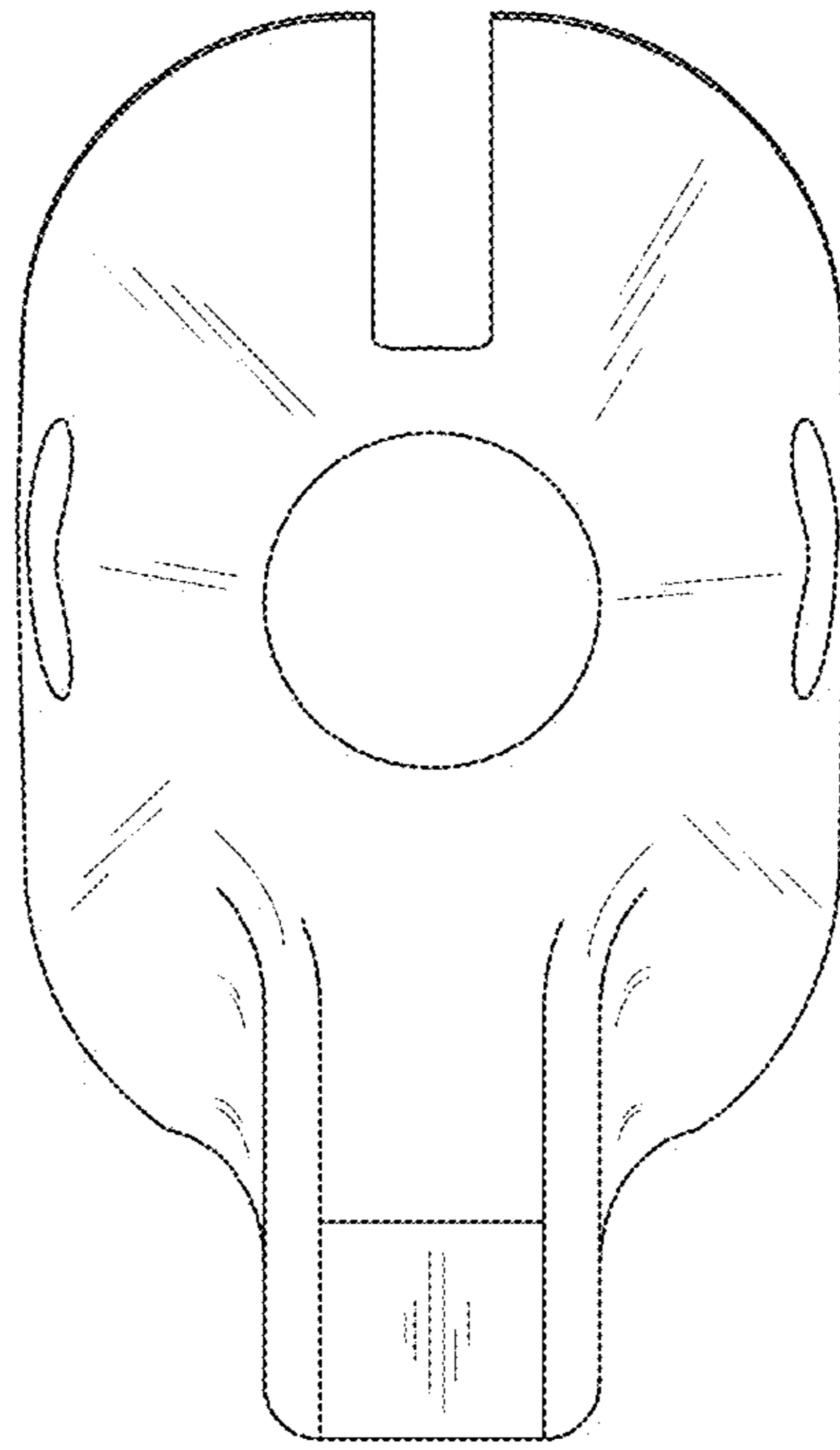

FIG. 8