



US00D884660S

(12) **United States Design Patent**
Sakamoto et al.

(10) **Patent No.:** **US D884,660 S**

(45) **Date of Patent:** **** *May 19, 2020**

(54) **LIGHT-RECEIVING DEVICE**

H01L 31/035236; H01L 31/03046; H01L 31/00; H01L 31/0352; H01L 31/0304

(71) Applicant: **HAMAMATSU PHOTONICS K.K.**,
Hamamatsu-shi, Shizuoka (JP)

See application file for complete search history.

(72) Inventors: **Takeshi Sakamoto**, Hamamatsu (JP);
Tomoya Taguchi, Hamamatsu (JP)

(56) **References Cited**

U.S. PATENT DOCUMENTS

(73) Assignee: **HAMAMATSU PHOTONICS K.K.**,
Hamamatsu-shi, Shizuoka (JP)

(*) Notice: This patent is subject to a terminal disclaimer.

5,185,647	A *	2/1993	Vasquez	B82Y 20/00 257/17
D364,603	S *	11/1995	Tanaka	D13/165
D364,604	S *	11/1995	Tanaka	D13/165
D373,759	S *	9/1996	Tanaka	D13/165
6,294,795	B1 *	9/2001	Kano	B82Y 20/00 257/17
6,818,916	B2 *	11/2004	Kano	B82Y 20/00 257/12
D526,279	S *	8/2006	Kotyk	D13/158
D542,738	S *	5/2007	Pollard	D13/158
D564,975	S *	3/2008	Horio	D13/165
8,058,642	B2 *	11/2011	Iguchi	B82Y 20/00 257/21
8,188,559	B2 *	5/2012	Iguchi	B82Y 20/00 257/21
8,426,845	B2 *	4/2013	Chen	B82Y 10/00 257/14
D739,359	S *	9/2015	Creasman	D13/165
9,647,155	B1 *	5/2017	Maimon	H01L 31/03523
9,698,297	B2 *	7/2017	Iguchi	H01L 27/1446
10,128,294	B2 *	11/2018	Migita	H01L 27/14634

(**) Term: **15 Years**

(21) Appl. No.: **29/641,864**

(22) Filed: **Mar. 26, 2018**

(30) **Foreign Application Priority Data**

Sep. 27, 2017 (JP) 2017-021149
Sep. 27, 2017 (JP) 2017-021150

(51) **LOC (12) Cl.** **13-03**

(52) **U.S. Cl.**
USPC **D13/165**

(58) **Field of Classification Search**
USPC D13/182, 184, 165, 199; D26/1, 24, 51,
D26/52, 93, 113, 138, 152; D14/138 R,
D14/473, 255; D15/144.1, 199;
174/52.4; 250/239; 361/730, 752;
257/432, 21, 12, 14, 15, 17, 22, 186, 199,
257/431, 438, 458, 461, 464
CPC H01L 27/14634; H01L 27/14605; H01L
27/14607; H01L 27/14618; H01L
27/14636; H01L 27/14643; H01L 27/146;

FOREIGN PATENT DOCUMENTS

JP	2006-68816	A	3/2006
JP	2008-78236	A	4/2008
JP	1347740		1/2009
JP	2010-514223	A	4/2010
JP	2014-41925	A	3/2014
JP	1608528		7/2018
JP	1608529		7/2018

* cited by examiner

Primary Examiner — Elizabeth J Oswecki

(74) *Attorney, Agent, or Firm* — Faegre Drinker Biddle & Reath LLP

(57) **CLAIM**

The ornamental design for a light-receiving device, as shown and described.

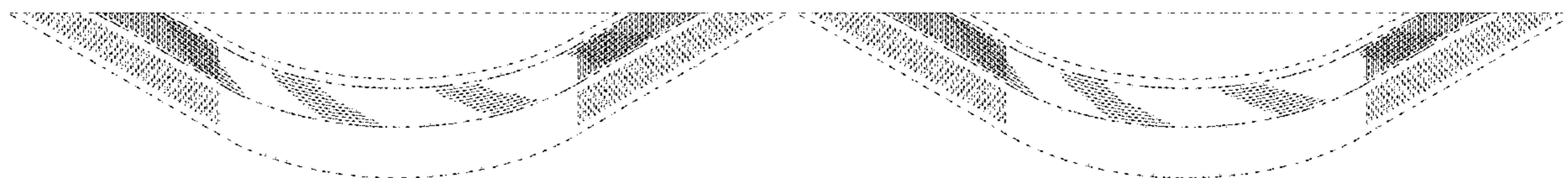

DESCRIPTION

FIG. 1 is a front view of a first embodiment of a light-receiving device, showing our new design;
 FIG. 2 is a rear view thereof;
 FIG. 3 is a top plan view thereof;
 FIG. 4 is a bottom plan view thereof;
 FIG. 5 is a right side view thereof;
 FIG. 6 is a left side view thereof;
 FIG. 7 is a perspective view thereof;
 FIG. 8 is an enlarged encircled portion view labeled 8 in FIG. 1;
 FIG. 9 is an enlarged encircled portion view labeled 9 in FIG. 1;
 FIG. 10 is an enlarged encircled portion view labeled 10 in FIG. 1;
 FIG. 11 is an enlarged encircled portion view labeled 11 in FIG. 1;
 FIG. 12 is an enlarged encircled portion view labeled 12 in FIG. 3;
 FIG. 13 is an enlarged top plan encircled portion view labeled 13 in FIG. 3;
 FIG. 14 is an enlarged bottom plan encircled portion view labeled 14 in FIG. 4;
 FIG. 15 is an enlarged bottom plan encircled portion view labeled 15 in FIG. 4;
 FIG. 16 is an enlarged right side encircled portion view labeled 16 in FIG. 5;
 FIG. 17 is an enlarged right side encircled portion view labeled 17 in FIG. 5;
 FIG. 18 is an enlarged left side encircled portion view labeled 18 in FIG. 6;
 FIG. 19 is an enlarged left side encircled portion view labeled 19 of FIG. 6;
 FIG. 20 is an enlarged portion view taken along line 20-20 in FIG. 12;
 FIG. 21 is an enlarged portion view taken along line 21-21 in FIG. 12;
 FIG. 22 is an enlarged portion view taken along line 22-22 in FIG. 12;
 FIG. 23 is an enlarged portion view taken along line 23-23 in FIG. 13;
 FIG. 24 is an enlarged portion view taken along line 24-24 in FIG. 13;
 FIG. 25 is an enlarged portion view taken along line 25-25 in FIG. 13;
 FIG. 26 is an enlarged portion view taken along line 26-26 in FIG. 14;
 FIG. 27 is an enlarged portion view taken along line 27-27 in FIG. 15;
 FIG. 28 is an enlarged portion view taken along line 28-28 in FIG. 16;
 FIG. 29 is an enlarged portion view taken along line 29-29 in FIG. 17;
 FIG. 30 is an enlarged portion view taken along line 30-30 in FIG. 18;
 FIG. 31 is an enlarged portion view taken along line 31-31 in FIG. 19;
 FIG. 32 is an enlarged cross-sectional portion view taken along line 32-32 in FIGS. 10, 11, and 26;
 FIG. 33 is an enlarged cross-sectional portion view taken along line 33-33 in FIG. 7;
 FIG. 34 is a front view of a second embodiment of a light-receiving device, showing our new design;
 FIG. 35 is a rear view thereof;

FIG. 36 is a top plan view thereof;
 FIG. 37 is a bottom plan view thereof;
 FIG. 38 is a right side view thereof;
 FIG. 39 is a left side view thereof;
 FIG. 40 is a perspective view thereof;
 FIG. 41 is an enlarged encircled portion view labeled 41 in FIG. 34;
 FIG. 42 is an enlarged encircled portion view labeled 42 in FIG. 34;
 FIG. 43 is an enlarged encircled portion view labeled 43 in FIG. 34;
 FIG. 44 is an enlarged encircled portion view labeled 44 in FIG. 34;
 FIG. 45 is an enlarged encircled portion view labeled 45 in FIG. 36;
 FIG. 46 is an enlarged top plan encircled portion view labeled 46 in FIG. 36;
 FIG. 47 is an enlarged bottom plan encircled portion view labeled 47 in FIG. 37;
 FIG. 48 is an enlarged bottom plan encircled portion view labeled 48 in FIG. 37;
 FIG. 49 is an enlarged right side encircled portion view labeled 49 in FIG. 38;
 FIG. 50 is an enlarged right side encircled portion view labeled 50 in FIG. 38;
 FIG. 51 is an enlarged left side encircled portion view labeled 51 in FIG. 39;
 FIG. 52 is an enlarged left side encircled portion view labeled 52 in FIG. 39;
 FIG. 53 is an enlarged portion view taken along line 53-53 in FIG. 45;
 FIG. 54 is an enlarged portion view taken along line 54-54 in FIG. 45;
 FIG. 55 is an enlarged portion view taken along line 55-55 in FIG. 45;
 FIG. 56 is an enlarged portion view taken along line 56-56 in FIG. 46;
 FIG. 57 is an enlarged portion view taken along line 57-57 in FIG. 46;
 FIG. 58 is an enlarged portion view taken along line 58-58 in FIG. 46;
 FIG. 59 is an enlarged portion view taken along line 59-59 in FIG. 47;
 FIG. 60 is an enlarged portion view taken along line 60-60 in FIG. 48;
 FIG. 61 is an enlarged portion view taken along line 61-61 in FIG. 49;
 FIG. 62 is an enlarged portion view taken along line 62-62 in FIG. 50;
 FIG. 63 is an enlarged portion view taken along line 63-63 in FIG. 51;
 FIG. 64 is an enlarged portion view taken along line 64-64 in FIG. 52;
 FIG. 65 is an enlarged cross-sectional portion view taken line 65-65 in FIGS. 43, 44, and 59; and,
 FIG. 66 is an enlarged cross-sectional portion view taken along line 66-66 in FIG. 40.
 The features shown in evenly-dashed broken lines depict environmental subject matter only and form no part of the claimed design. The dot-dot-dash broken lines in the drawings represent the bounds of the claimed subject matter, the dot-dot-dash broken lines, themselves forming no part thereof. The z-shaped break lines shown in FIGS. 1, 3, 4, 5,

6, 8-19, 22, 23, 34-39, 41-52, 55, and 56 depict boundaries of the enlarged portion views and form no part of the claimed design.

1 Claim, 66 Drawing Sheets

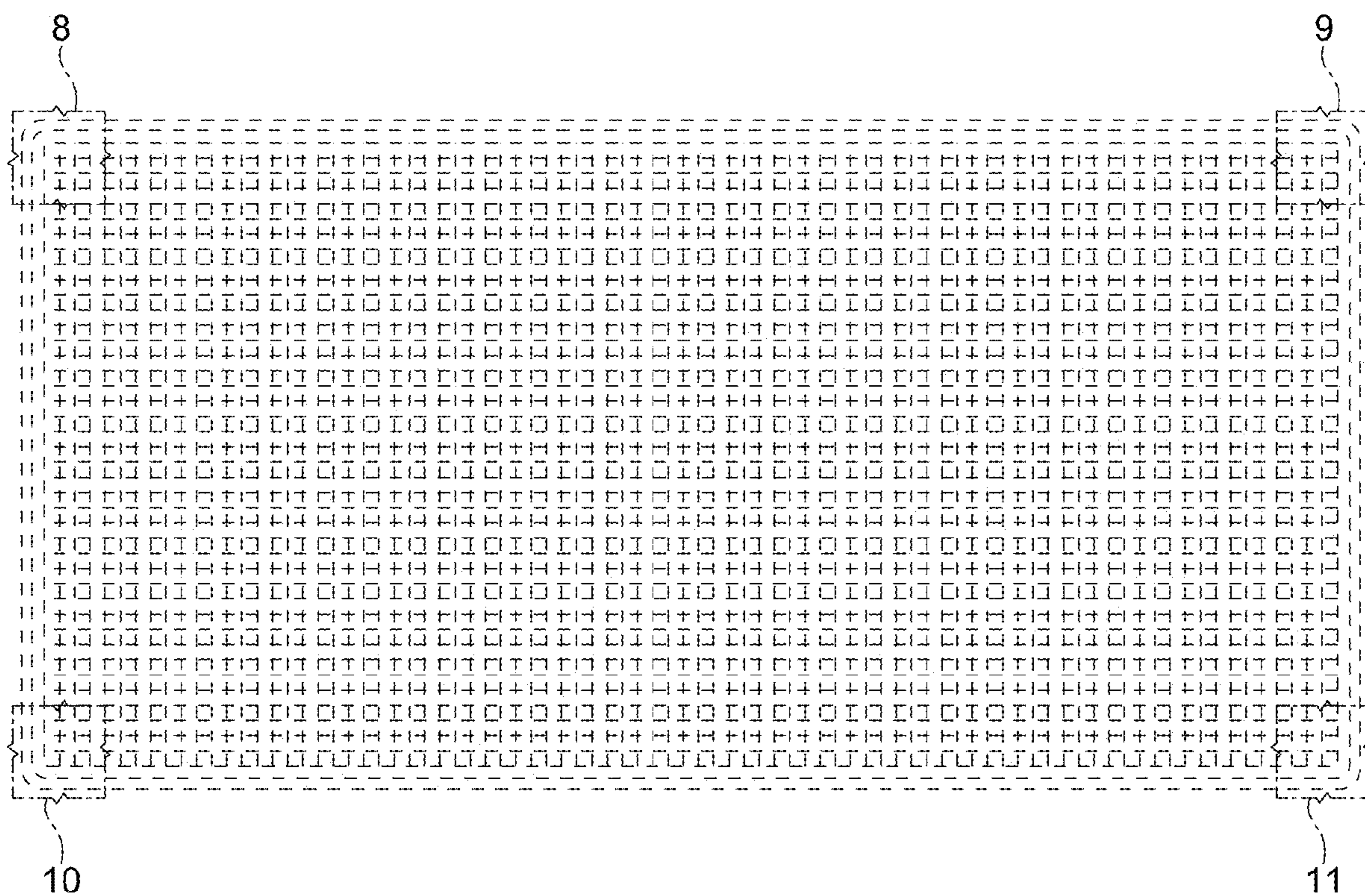

FIG. 1



FIG. 2



FIG. 3



FIG. 4



FIG. 5



FIG. 6

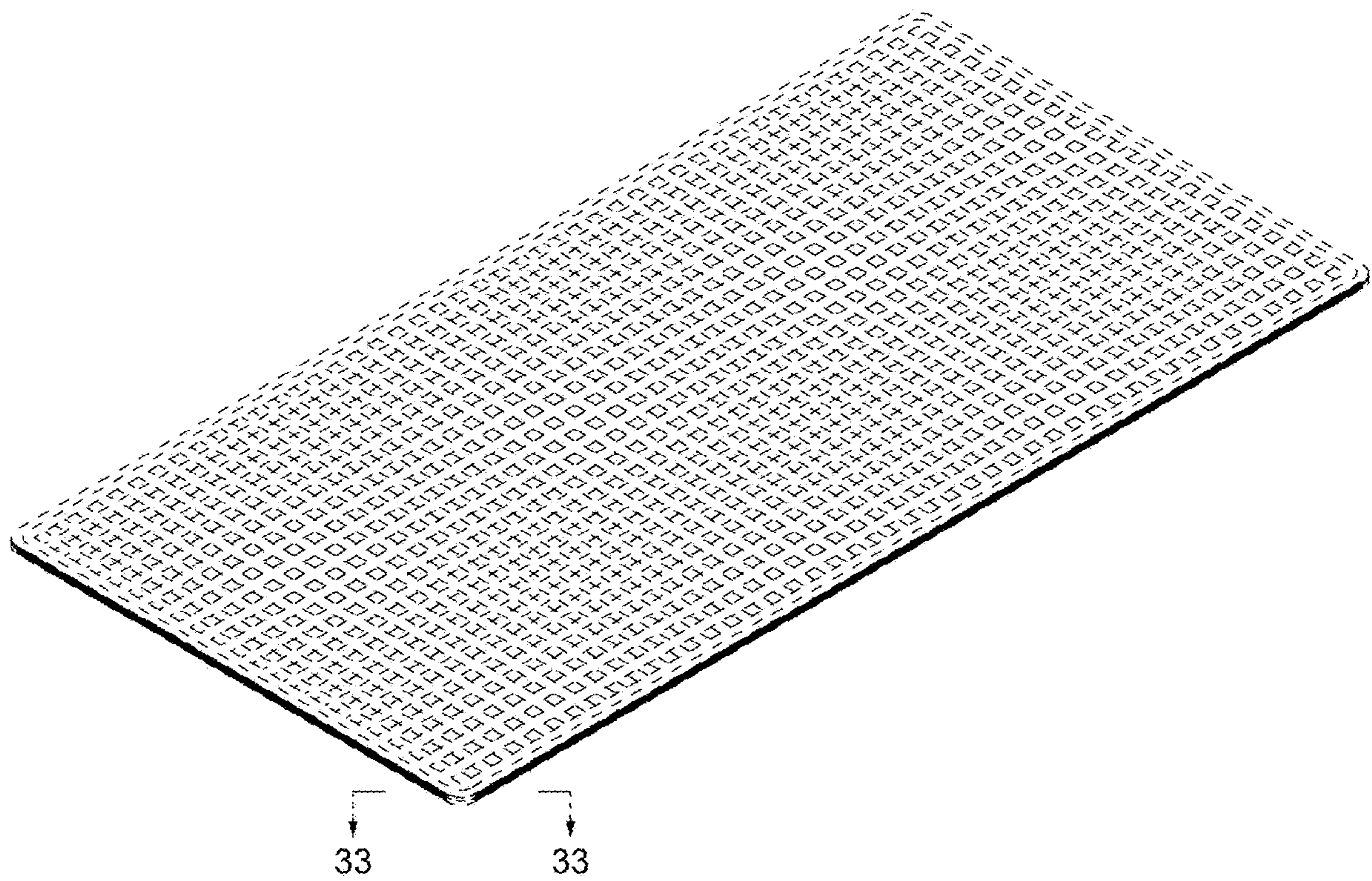

FIG. 7

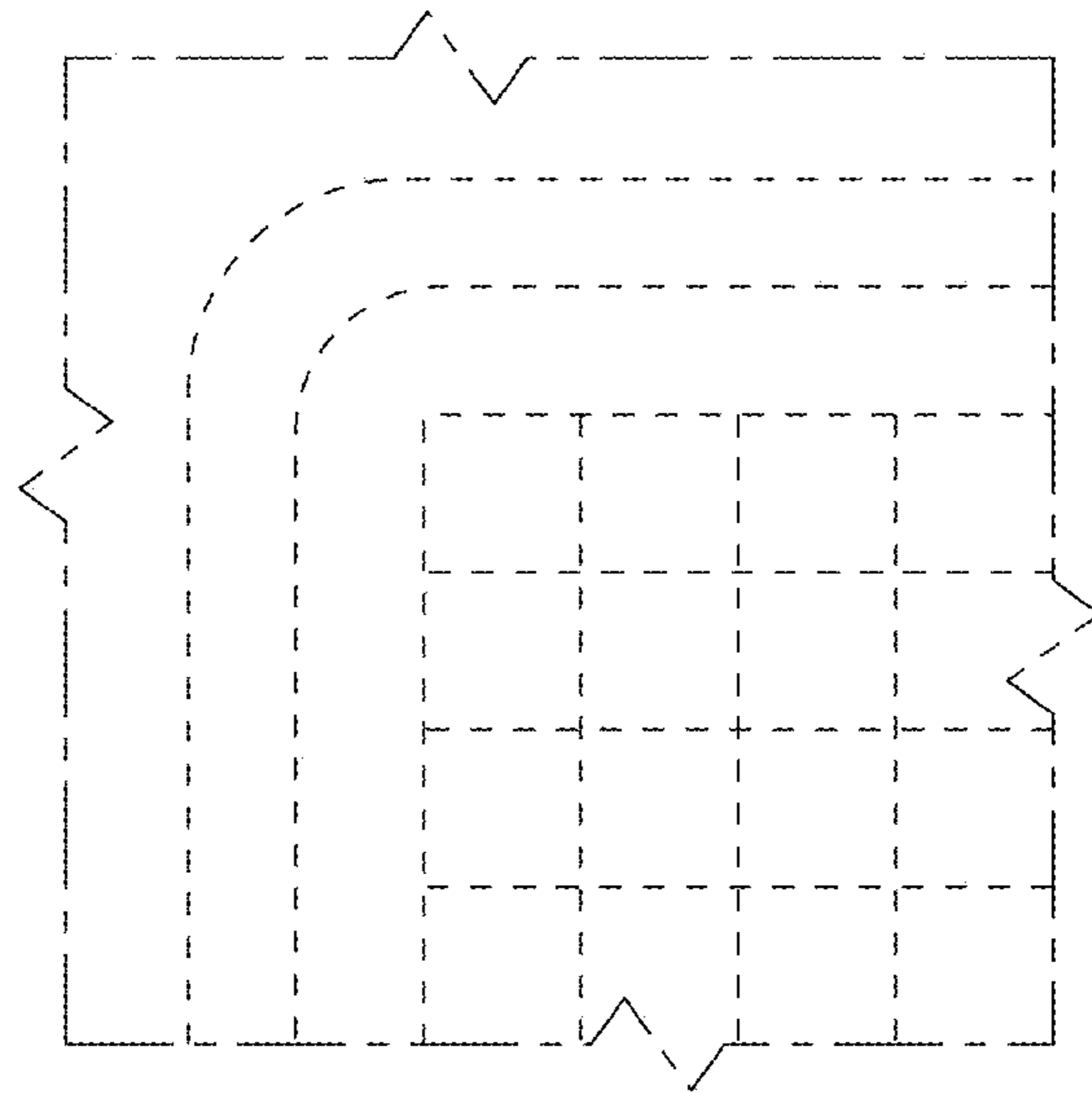

FIG. 8

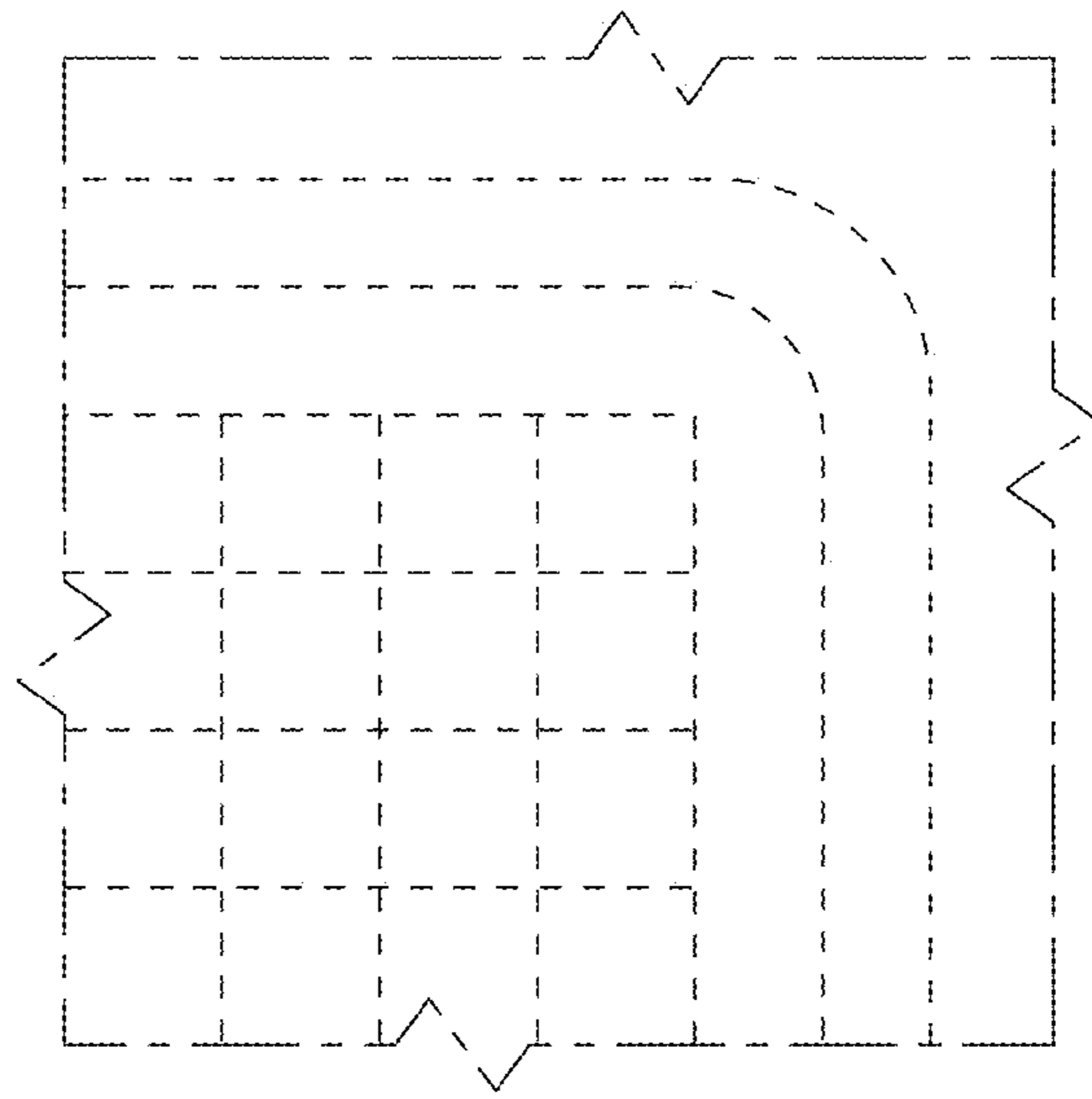

FIG. 9

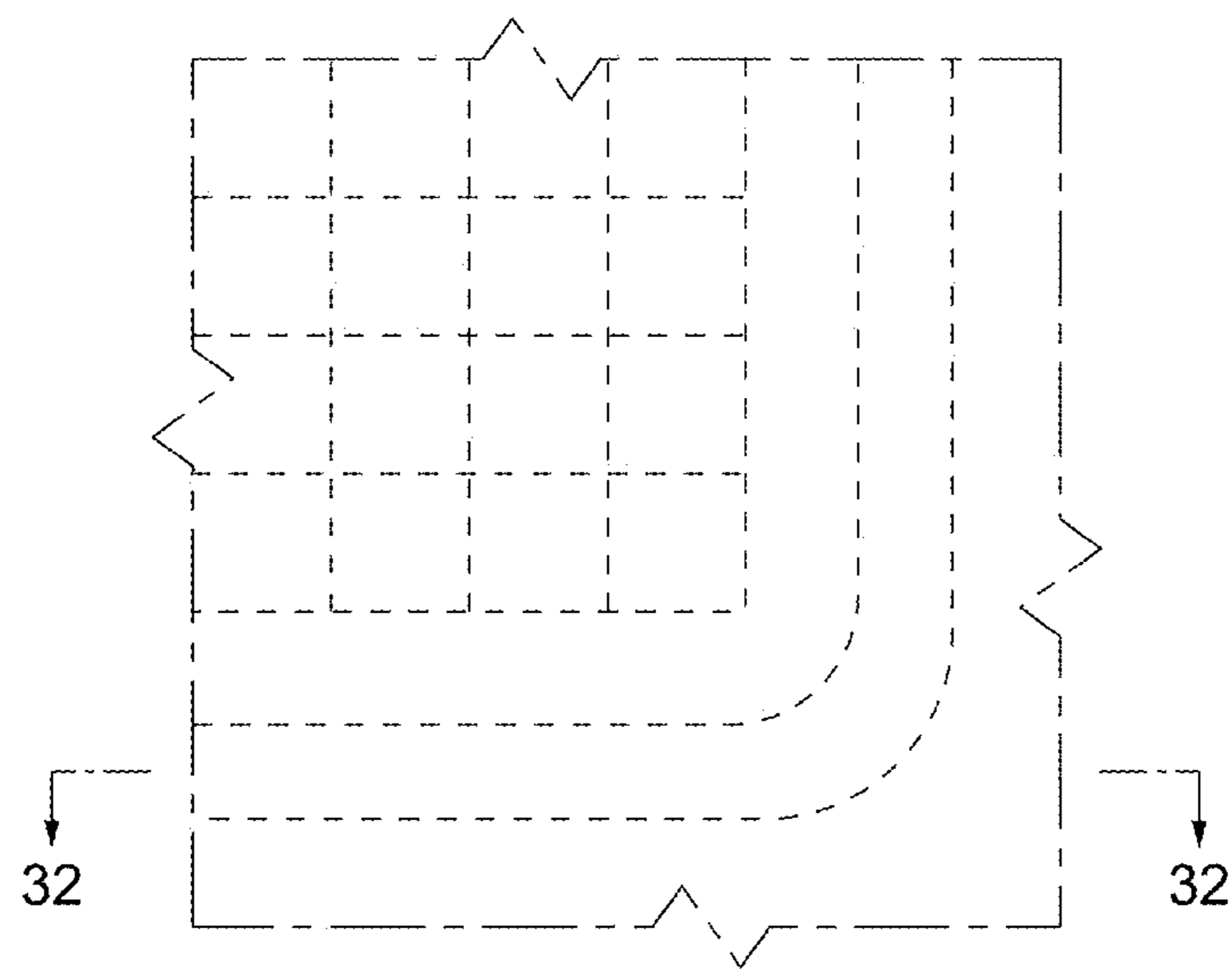

FIG. 11

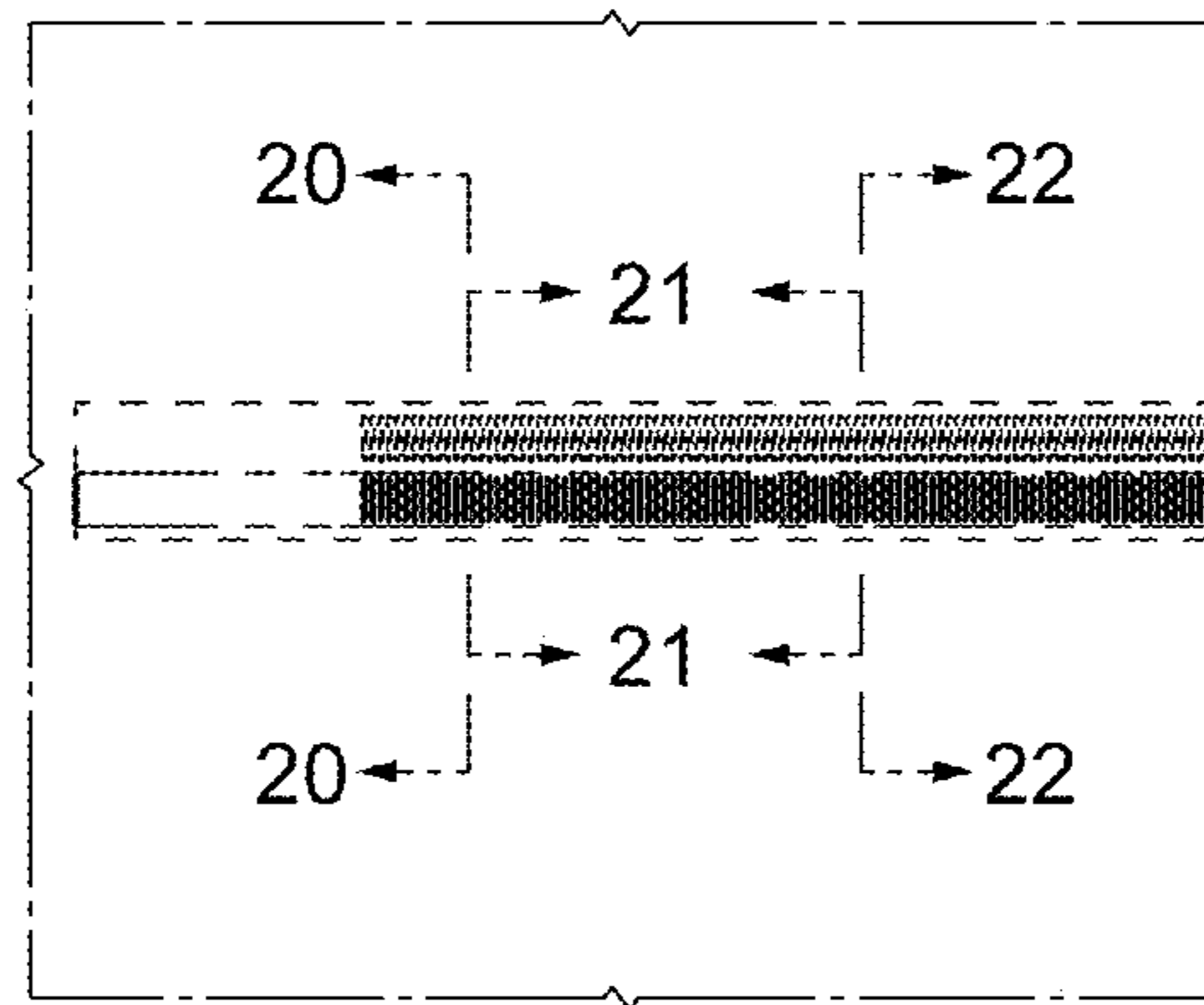

FIG. 12

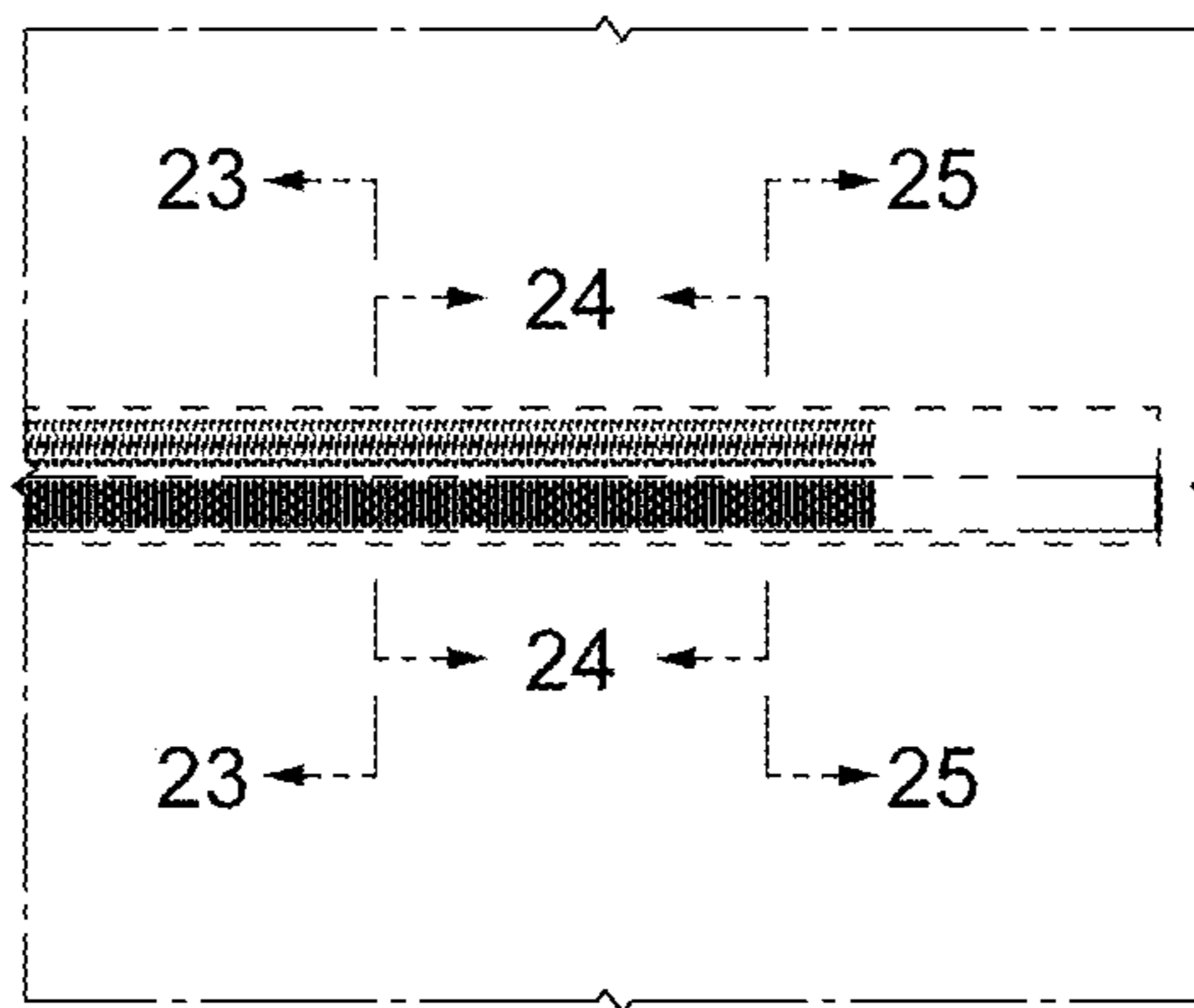

FIG. 13

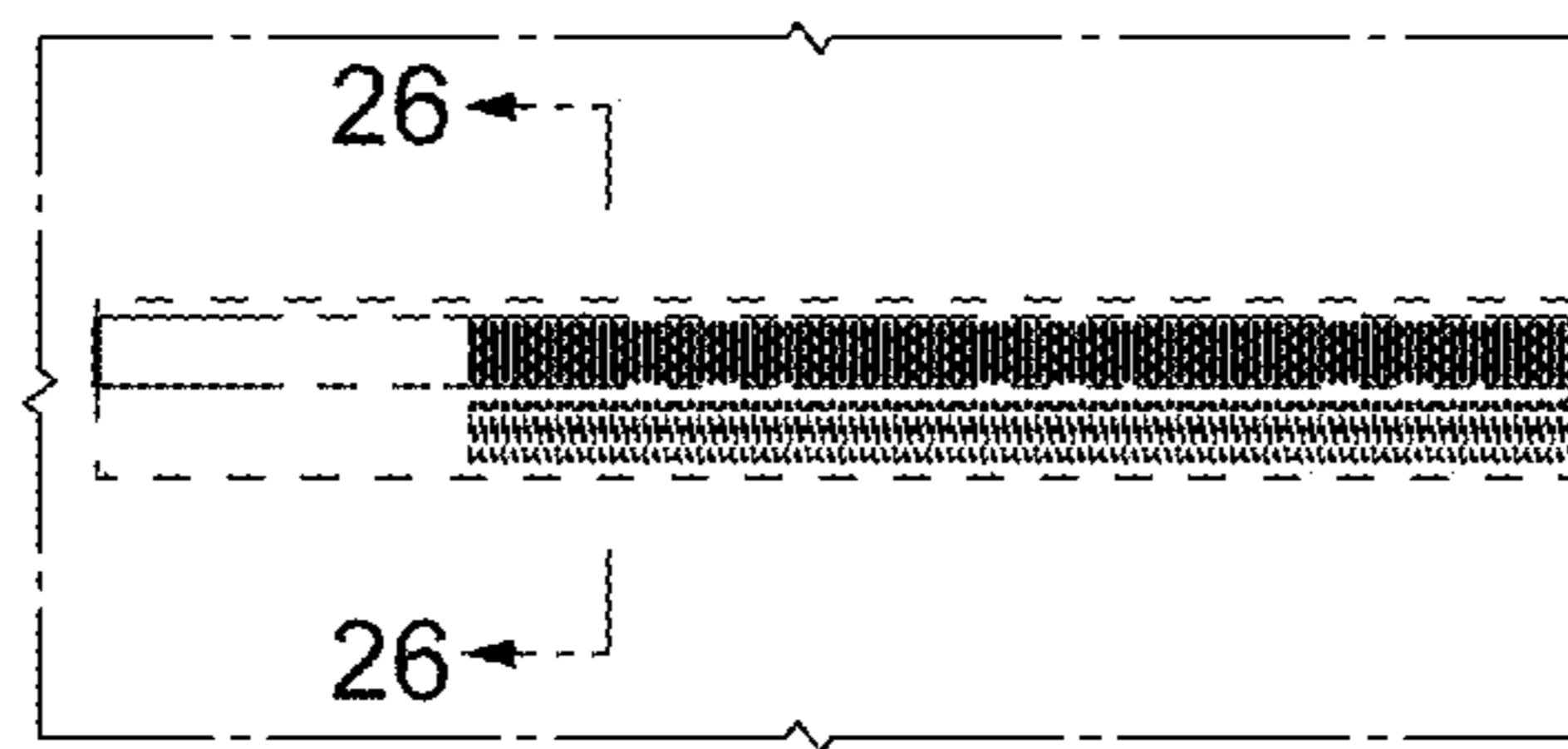

FIG. 14

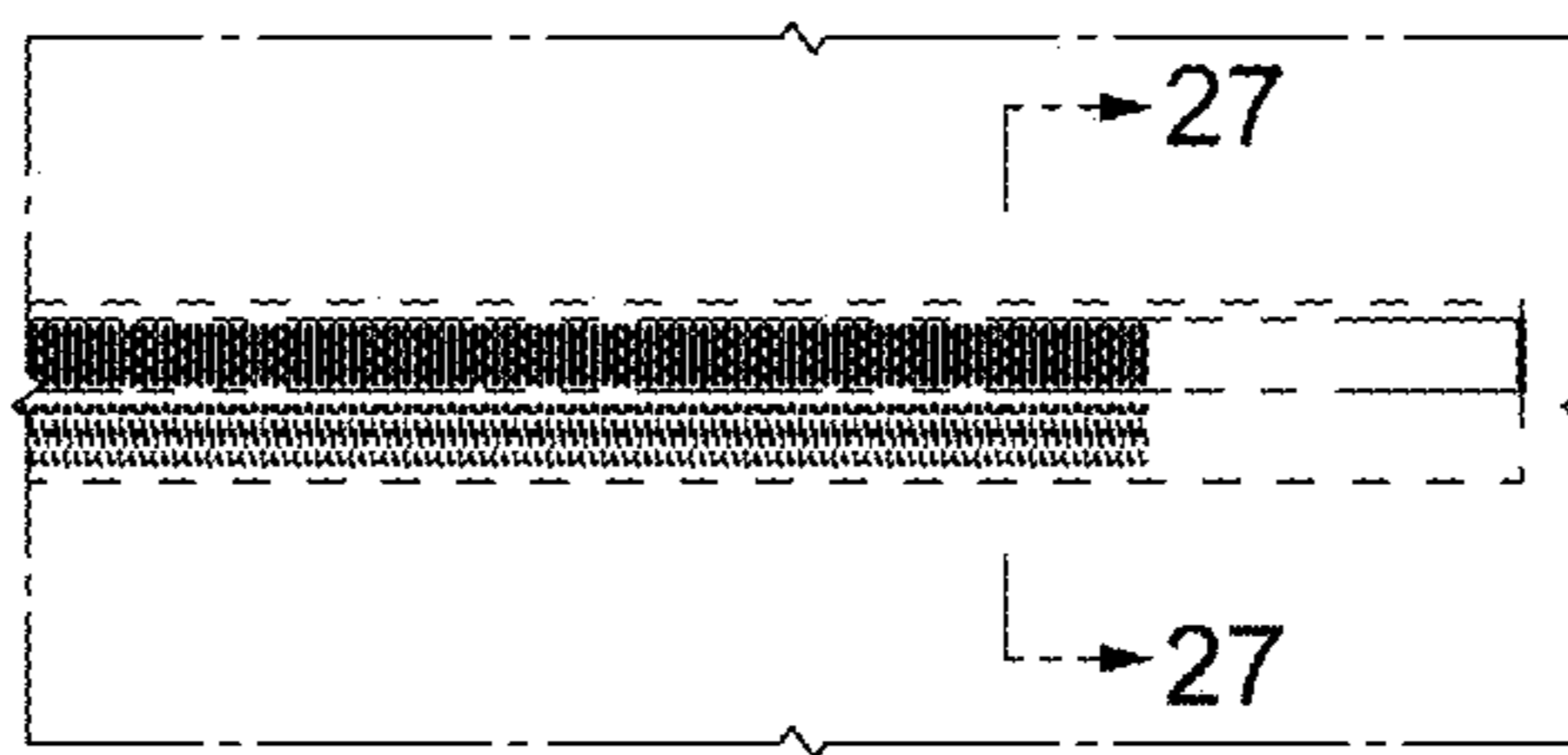

FIG. 15

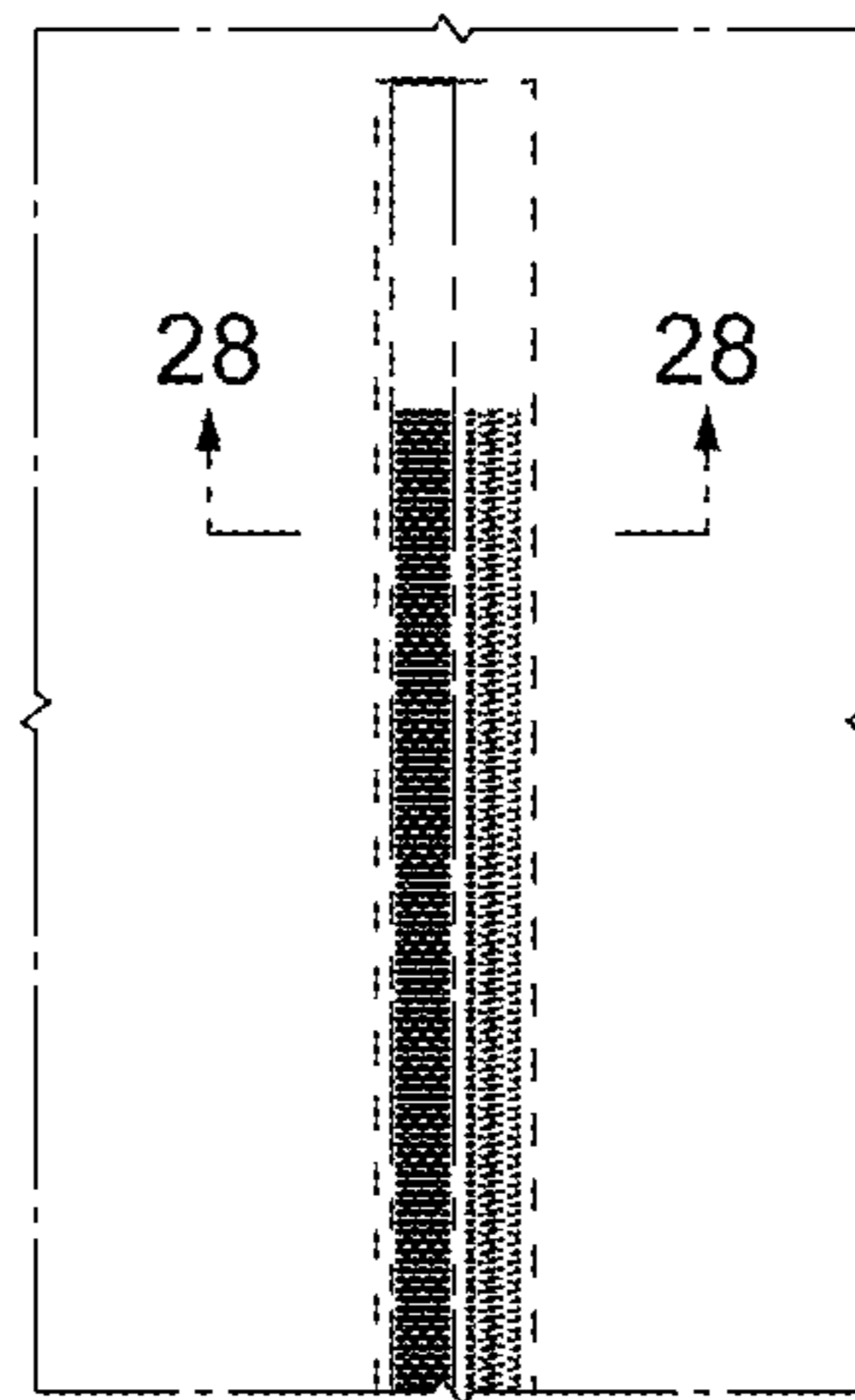

FIG. 16

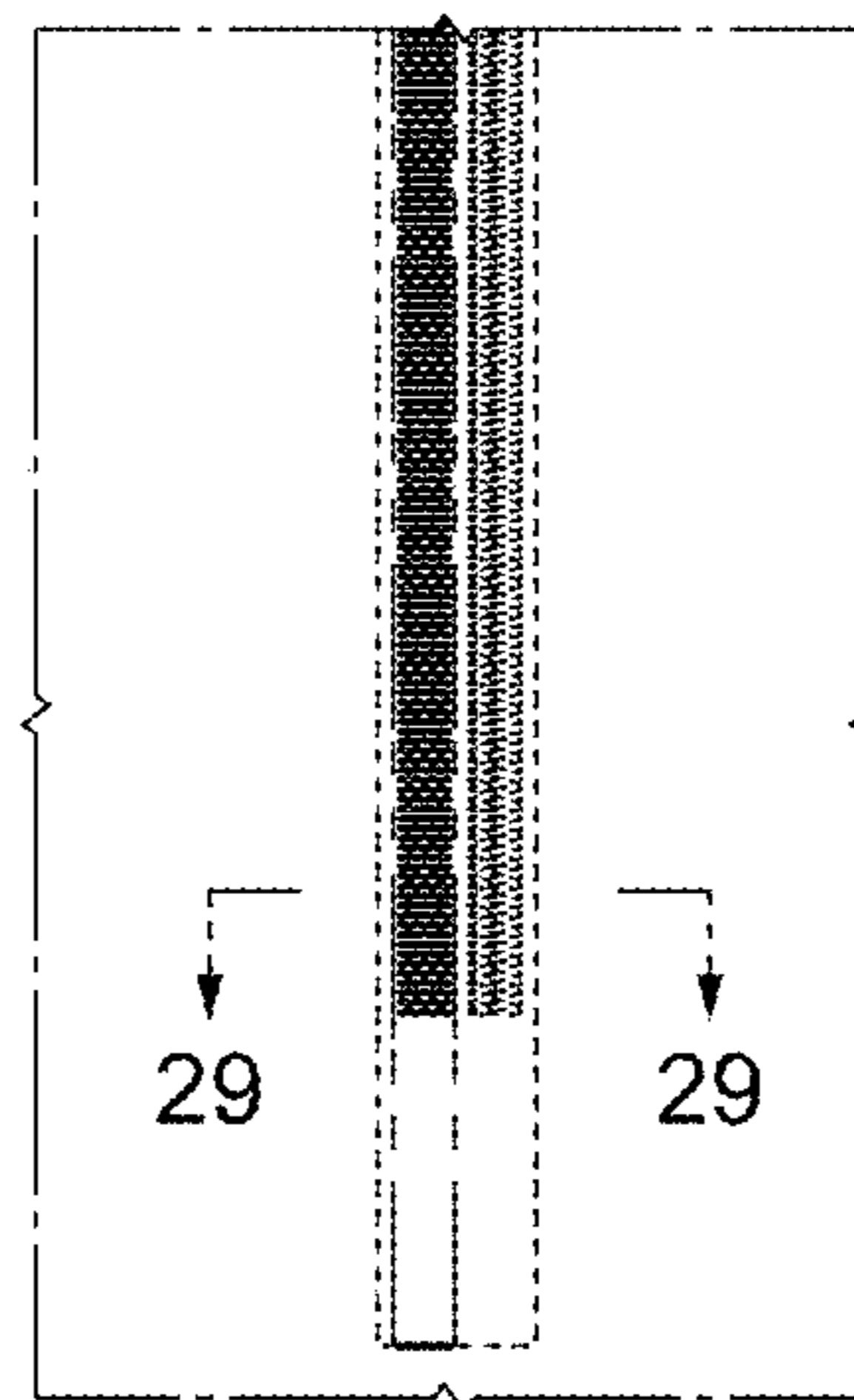

FIG. 17

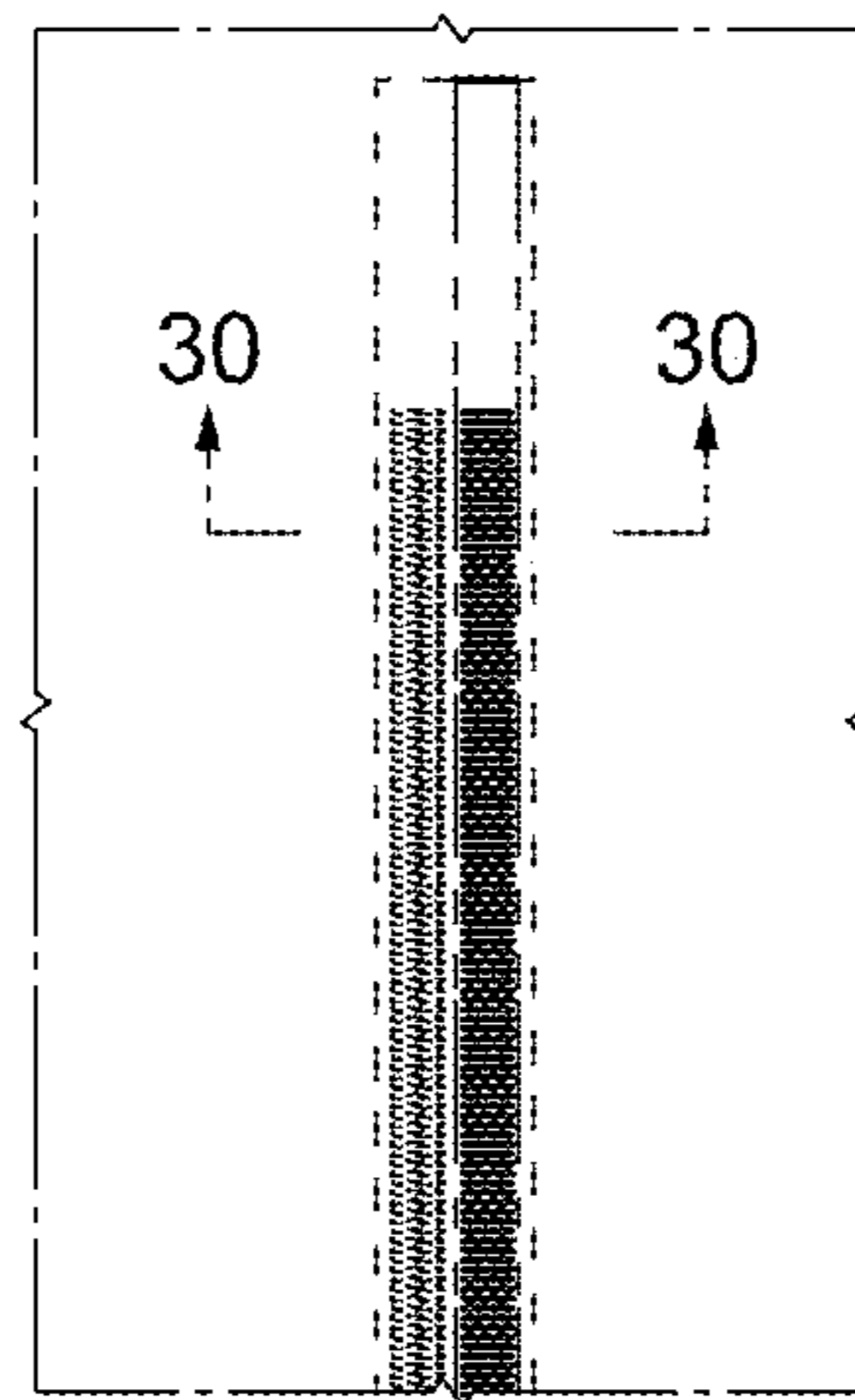

FIG. 18

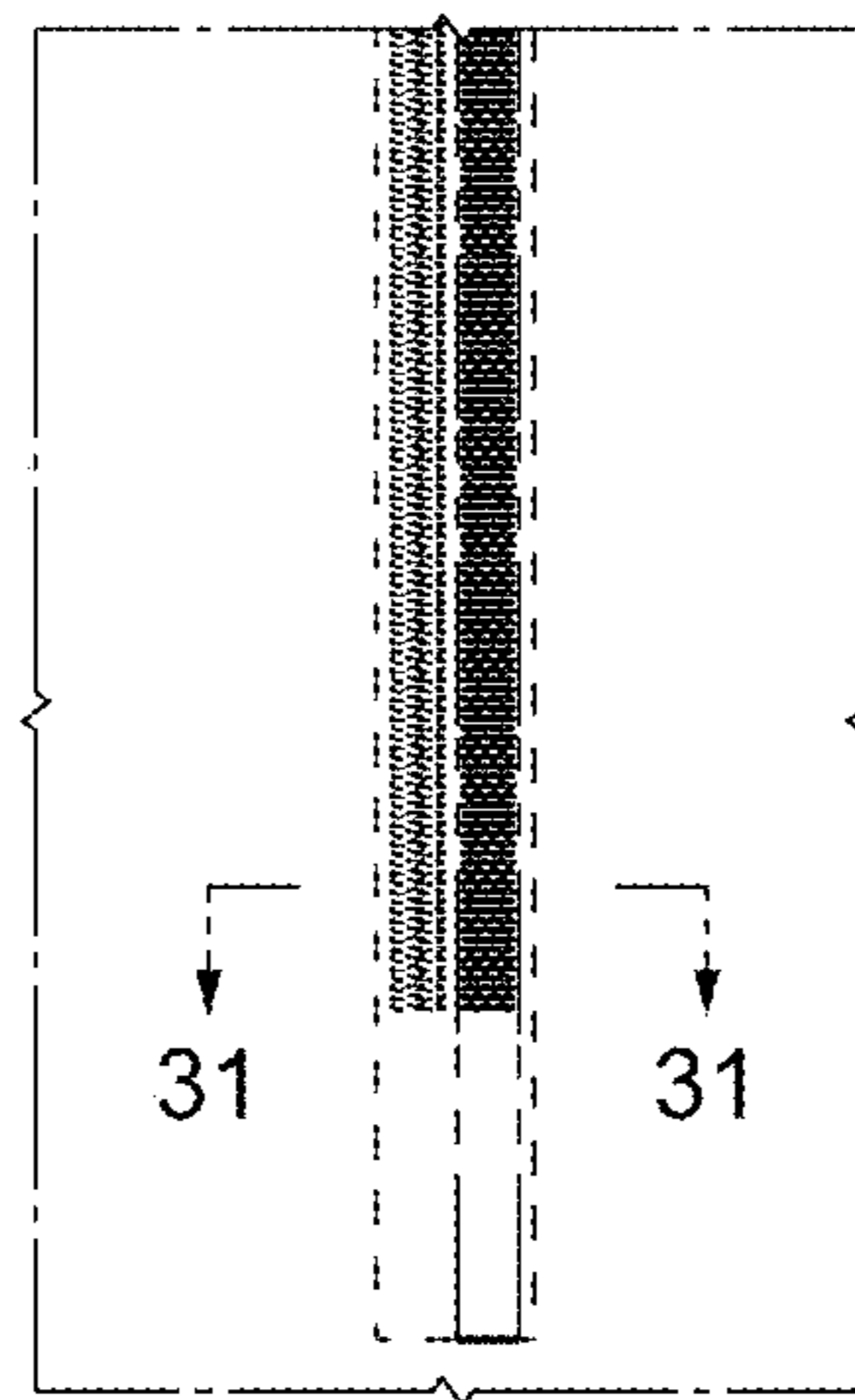

FIG. 19

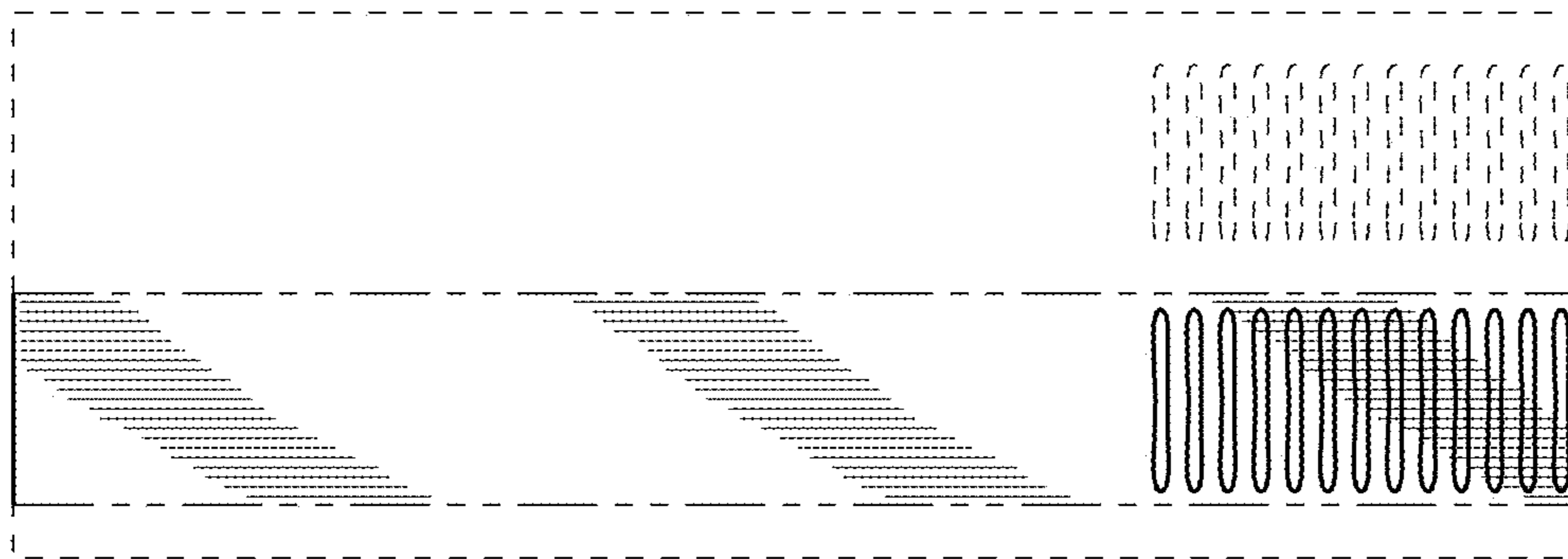

FIG. 20

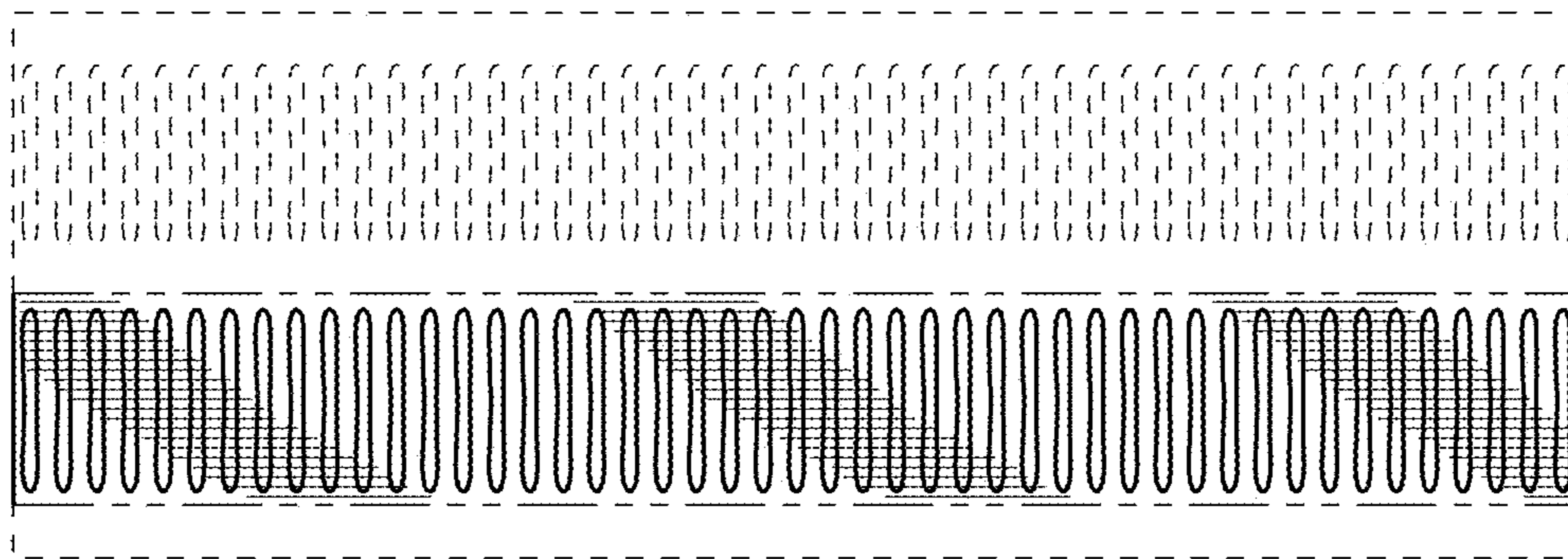

FIG. 21

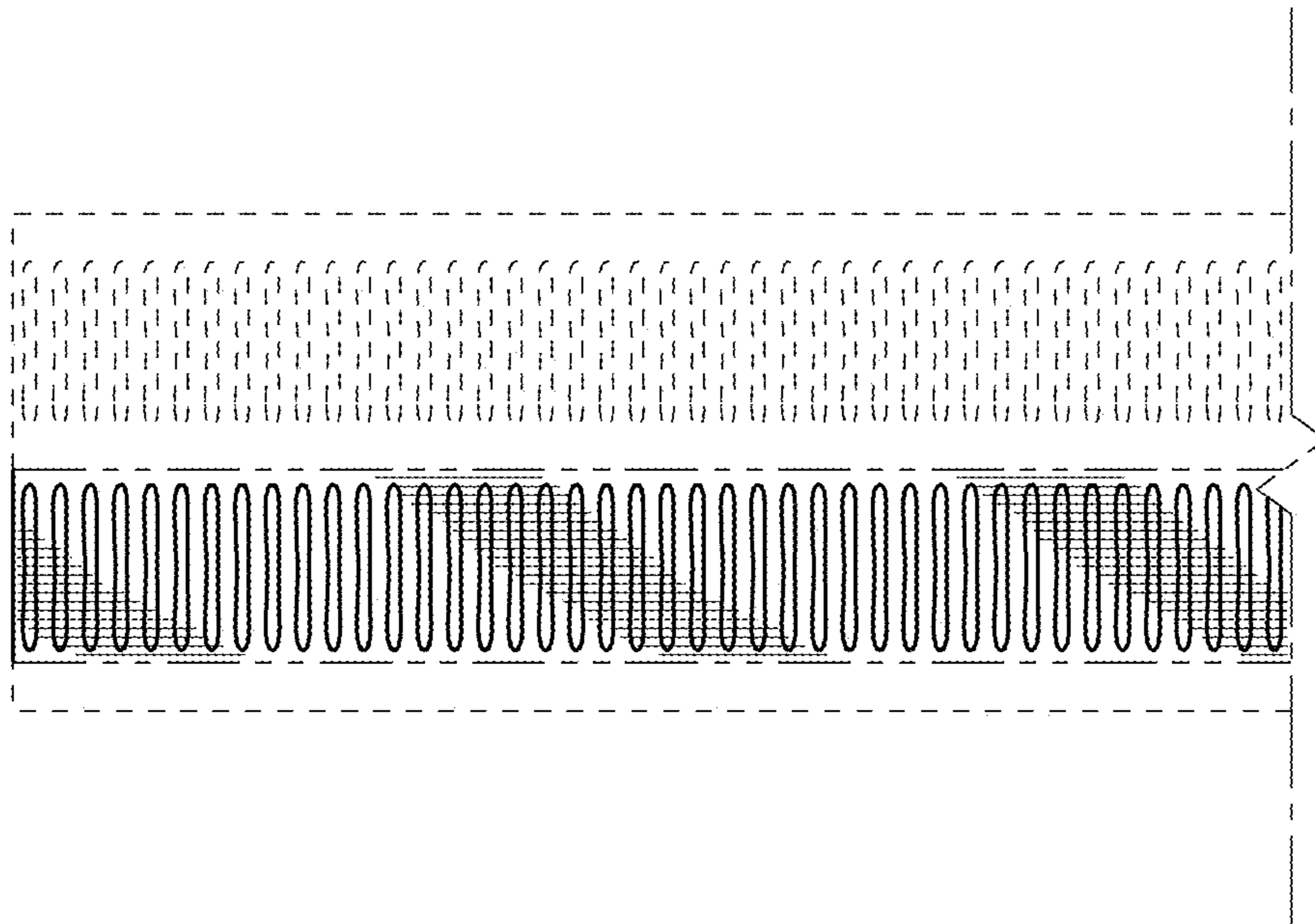

FIG. 22

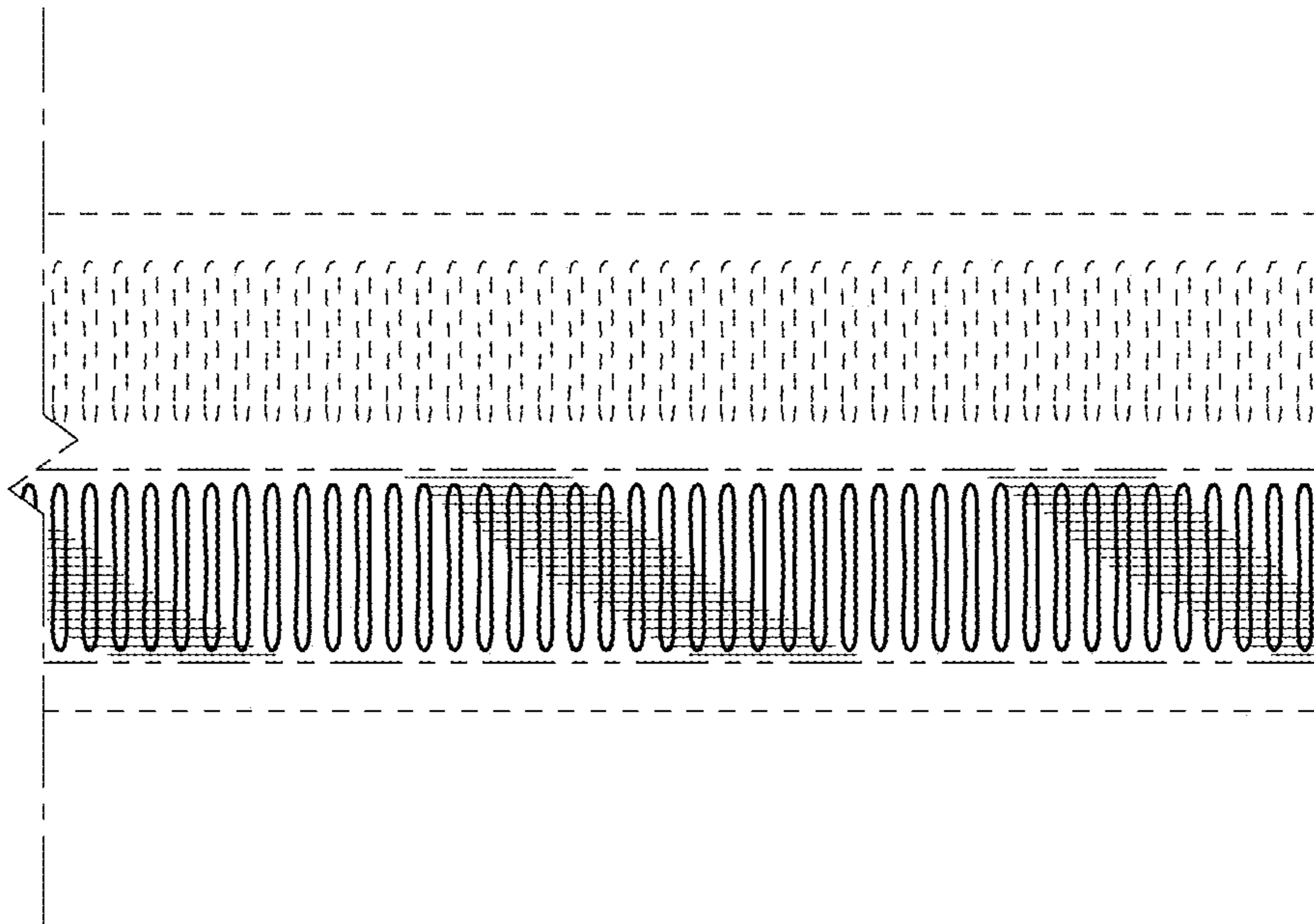

FIG. 23

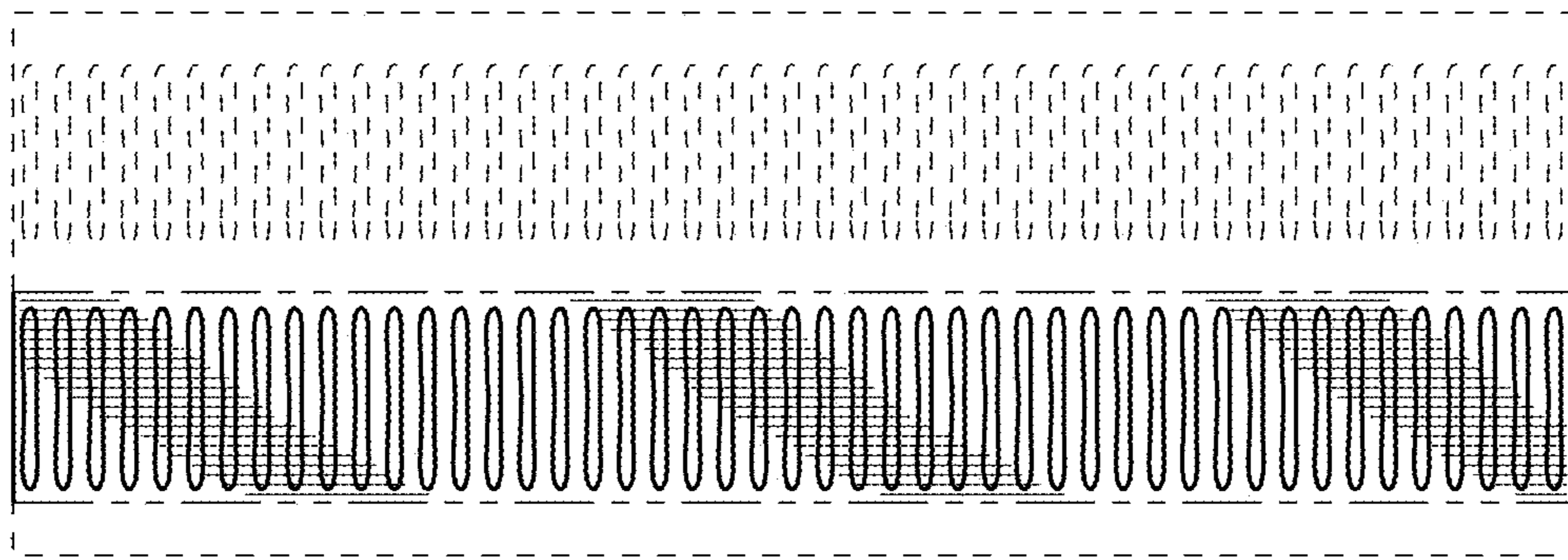

FIG. 24

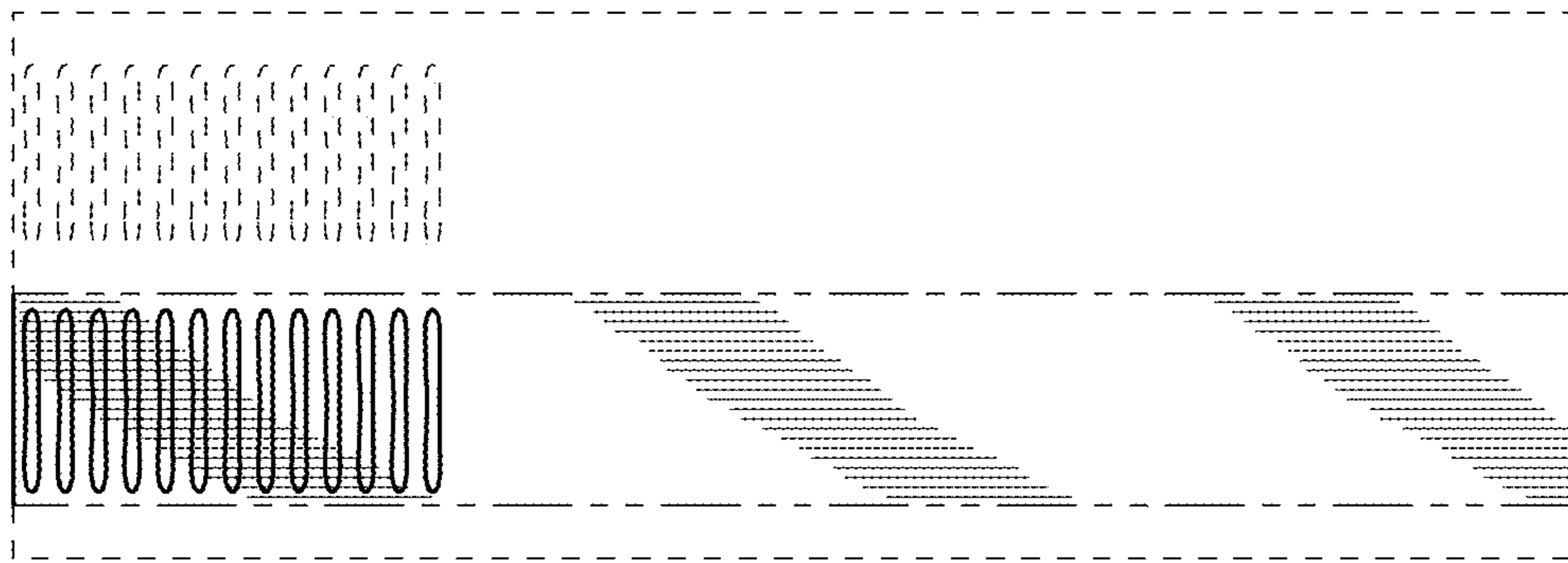

FIG. 25

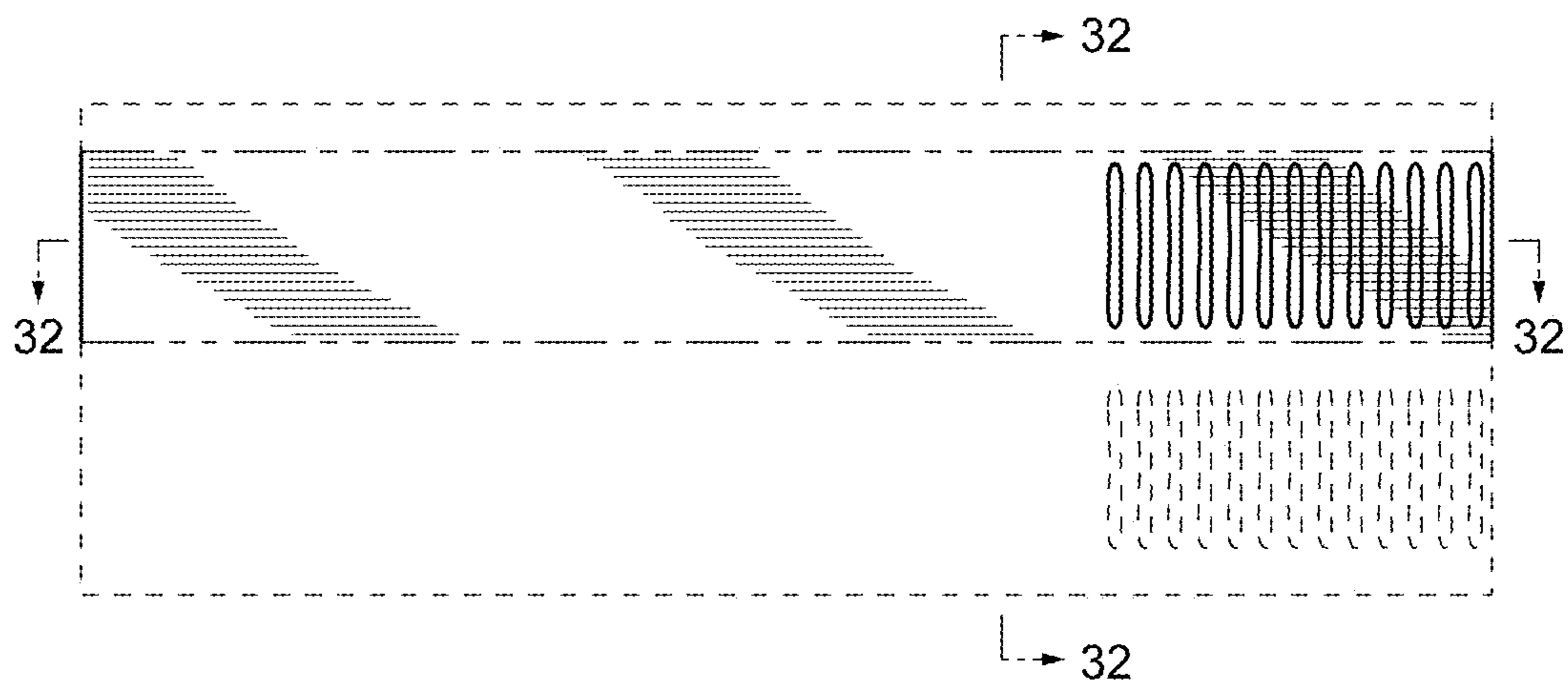

FIG. 26

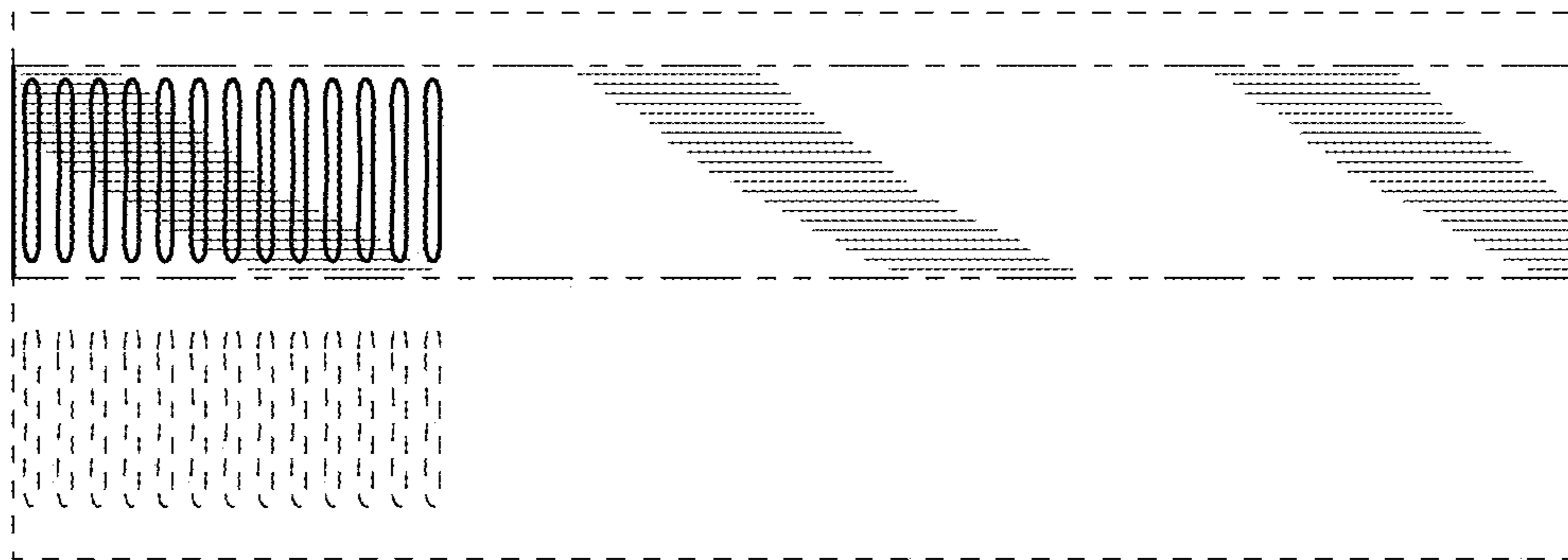

FIG. 27

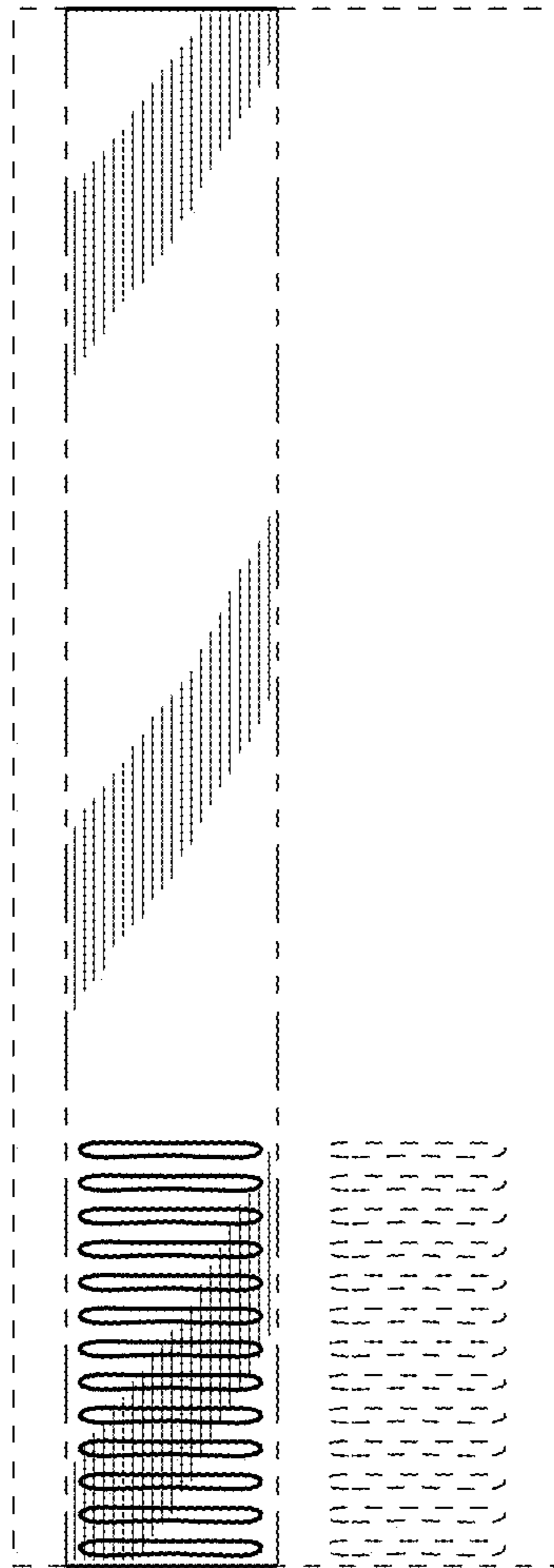

FIG. 28

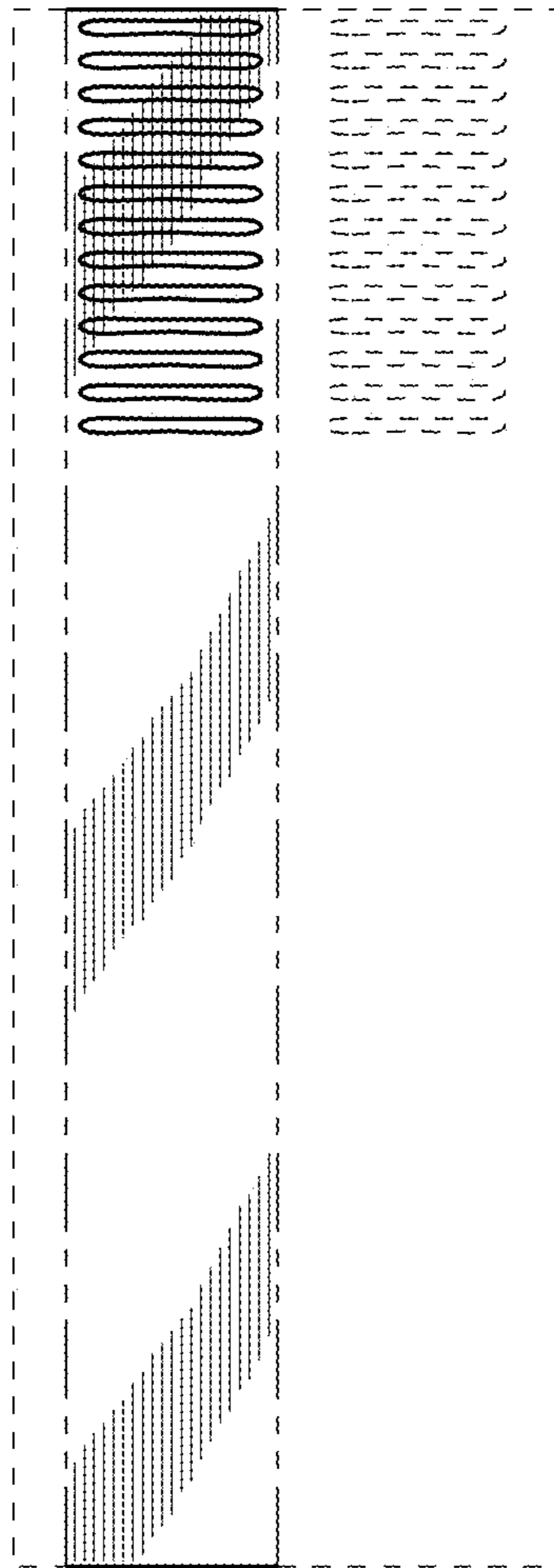

FIG. 29

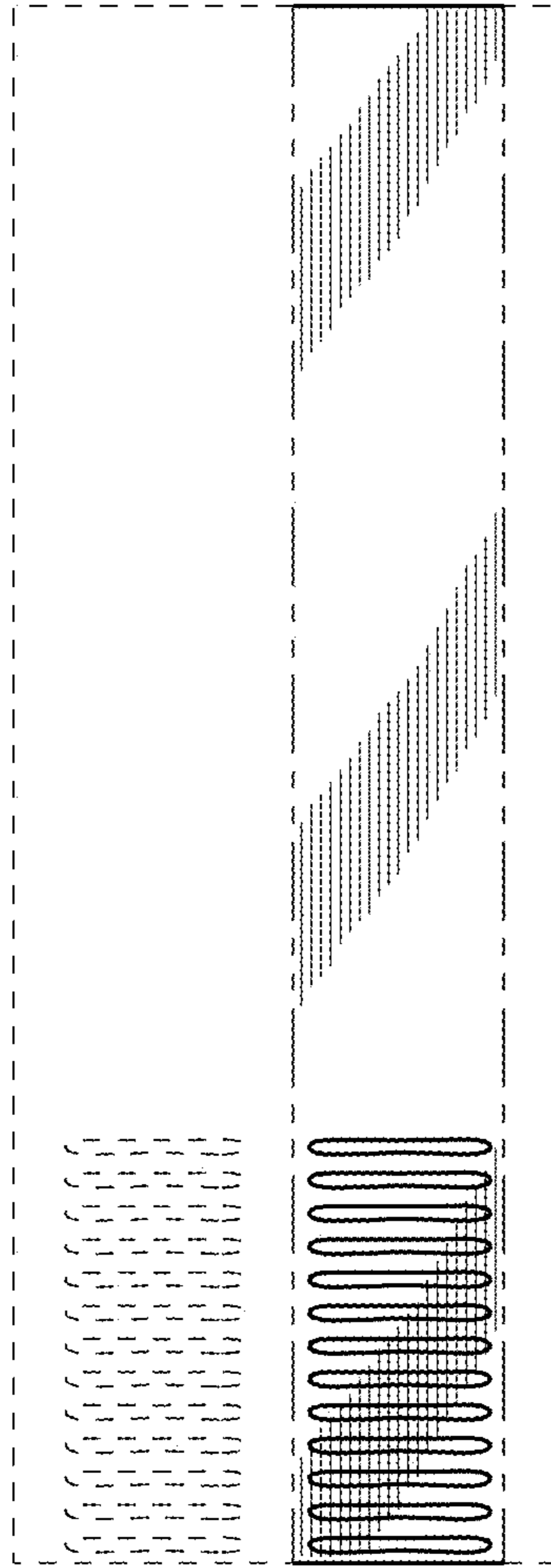

FIG. 30

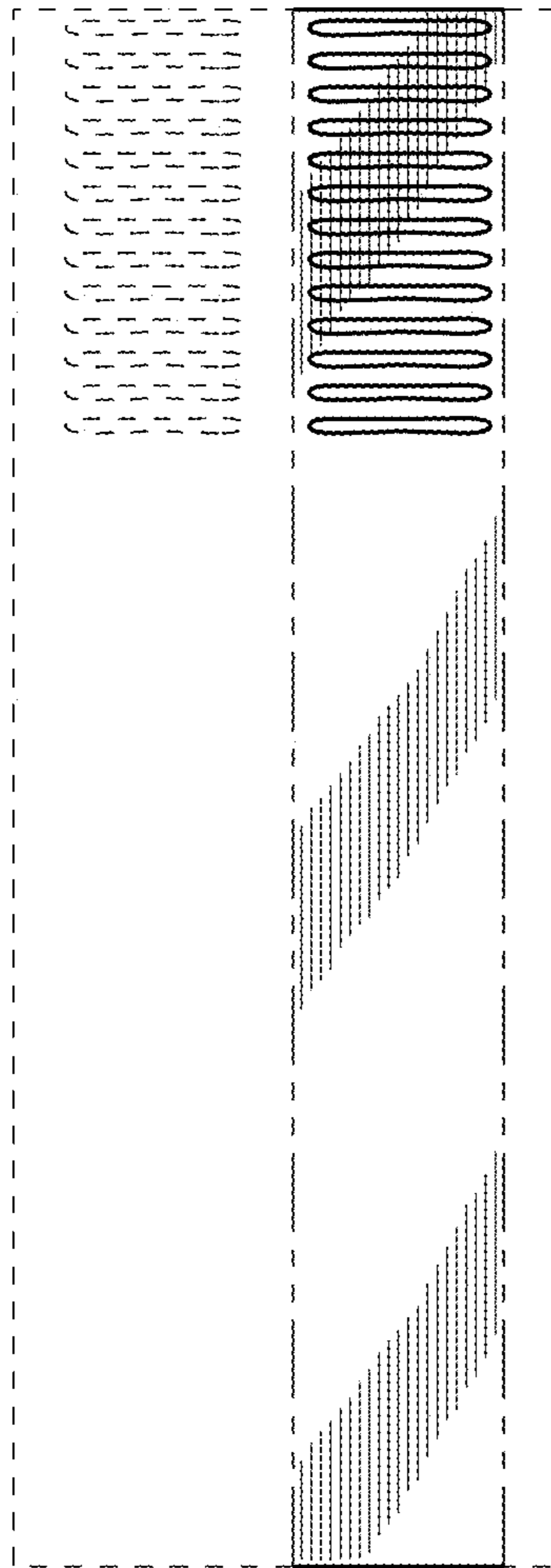

FIG. 31

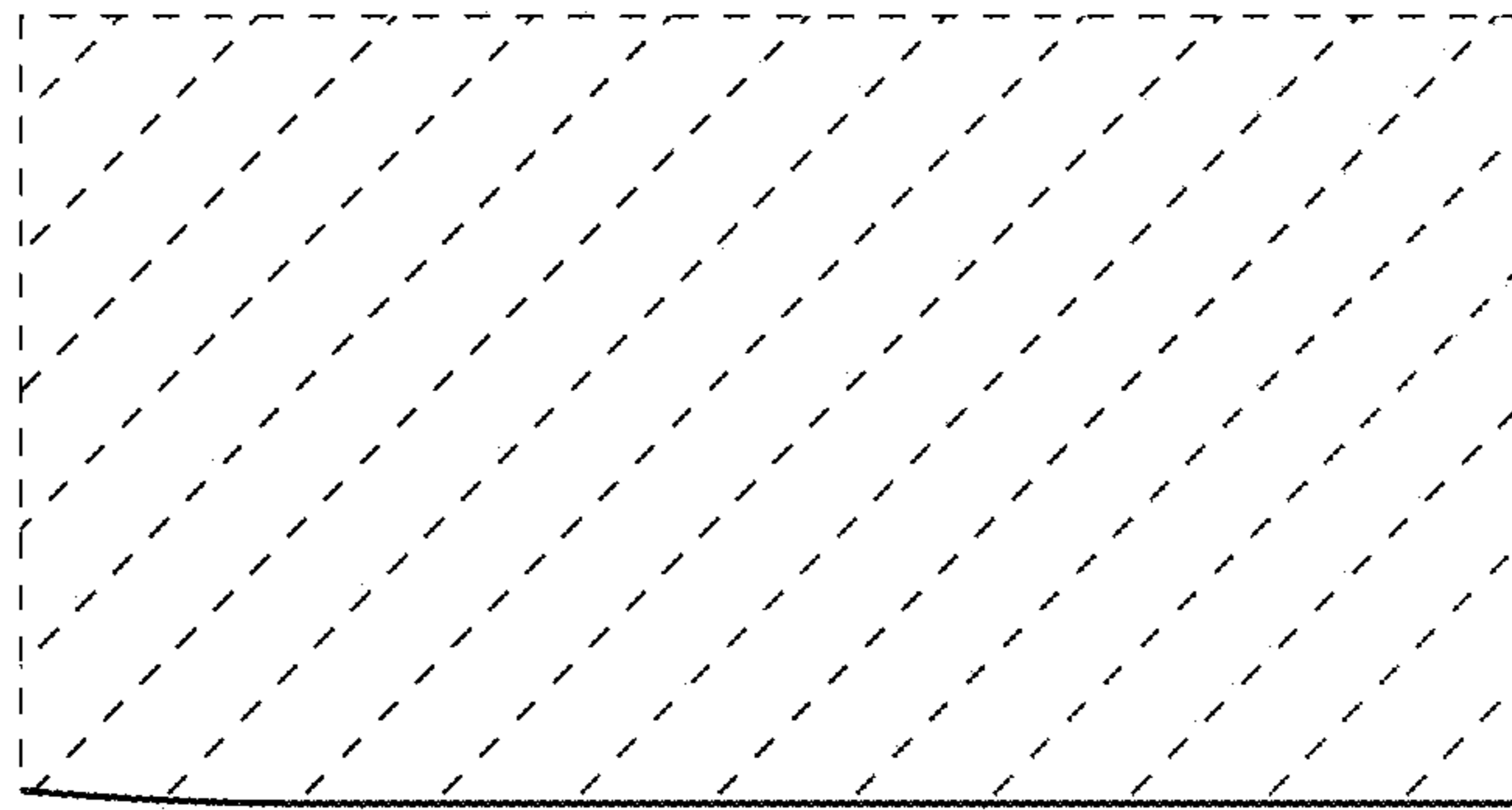

FIG. 32

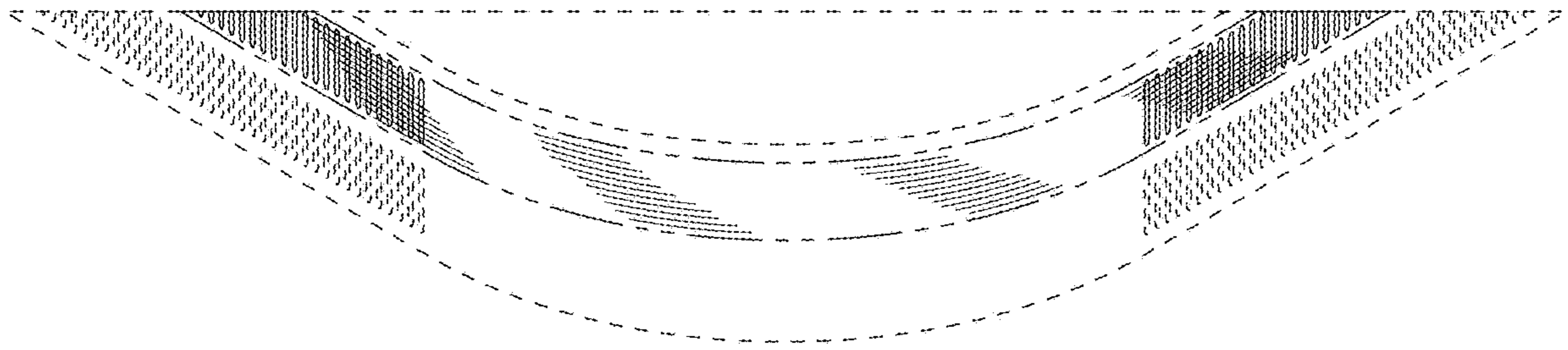

FIG. 33

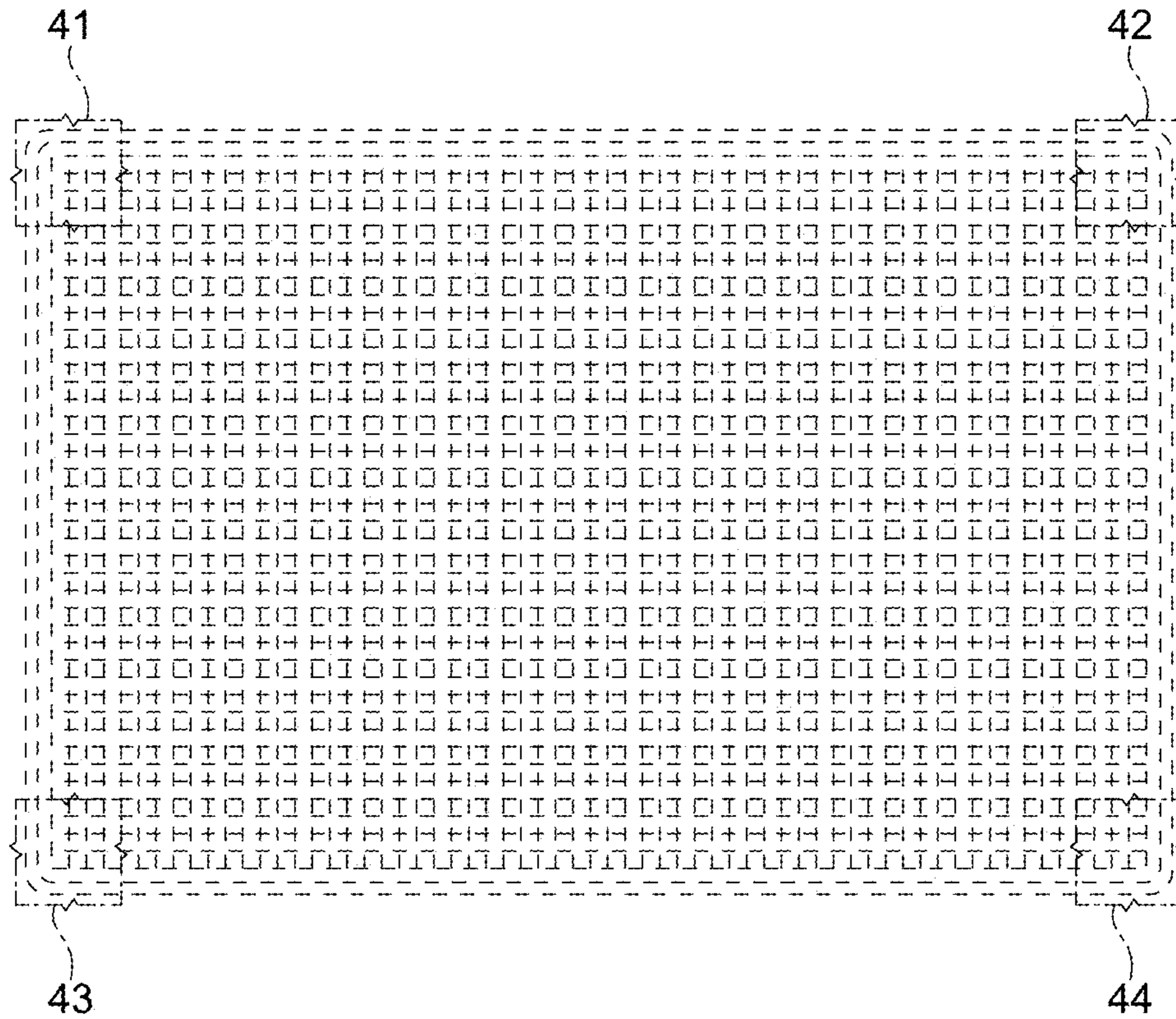

FIG. 34



FIG. 35



FIG. 36



FIG. 37



FIG. 38



FIG. 39

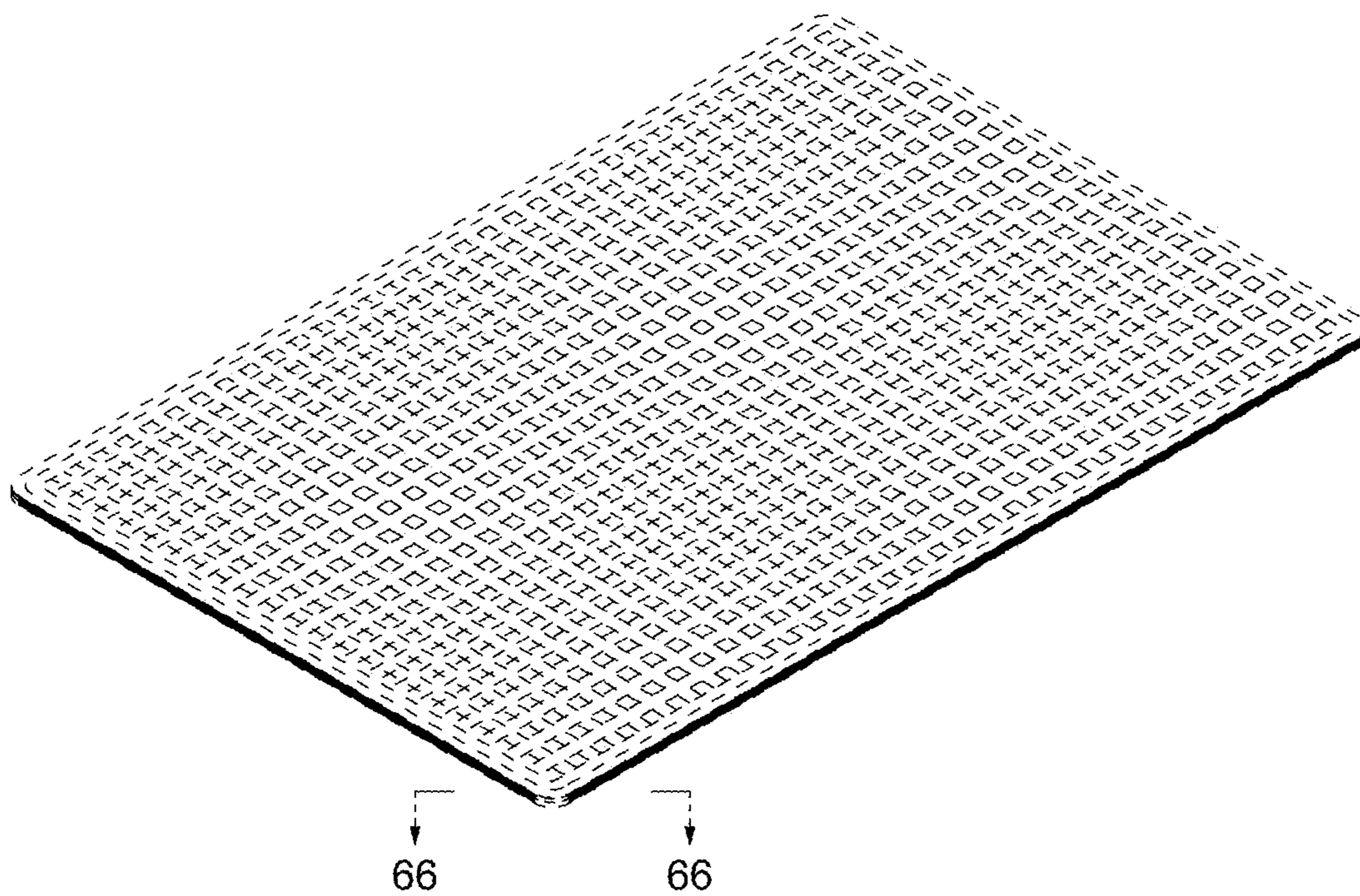

FIG. 40

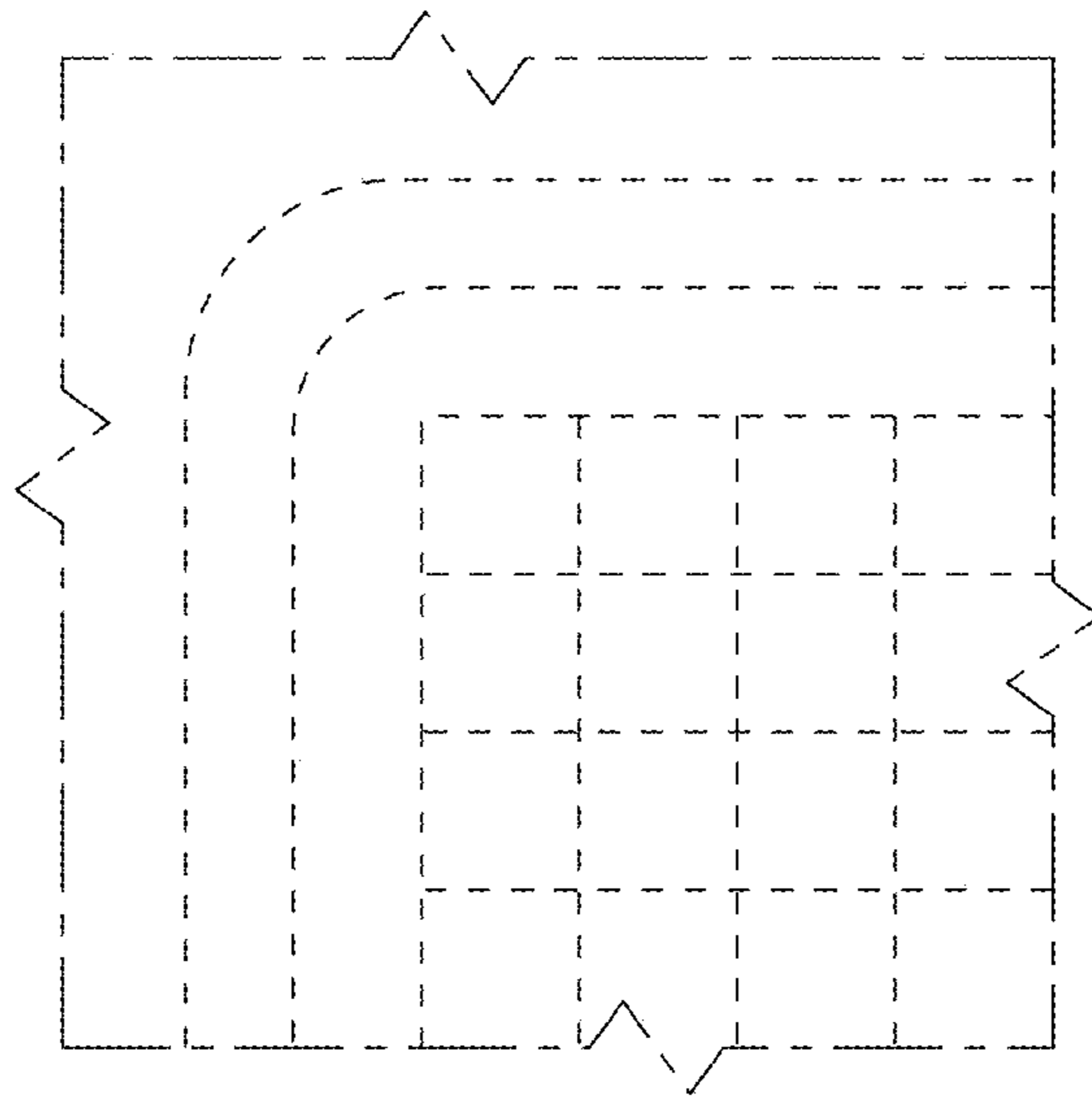

FIG. 41

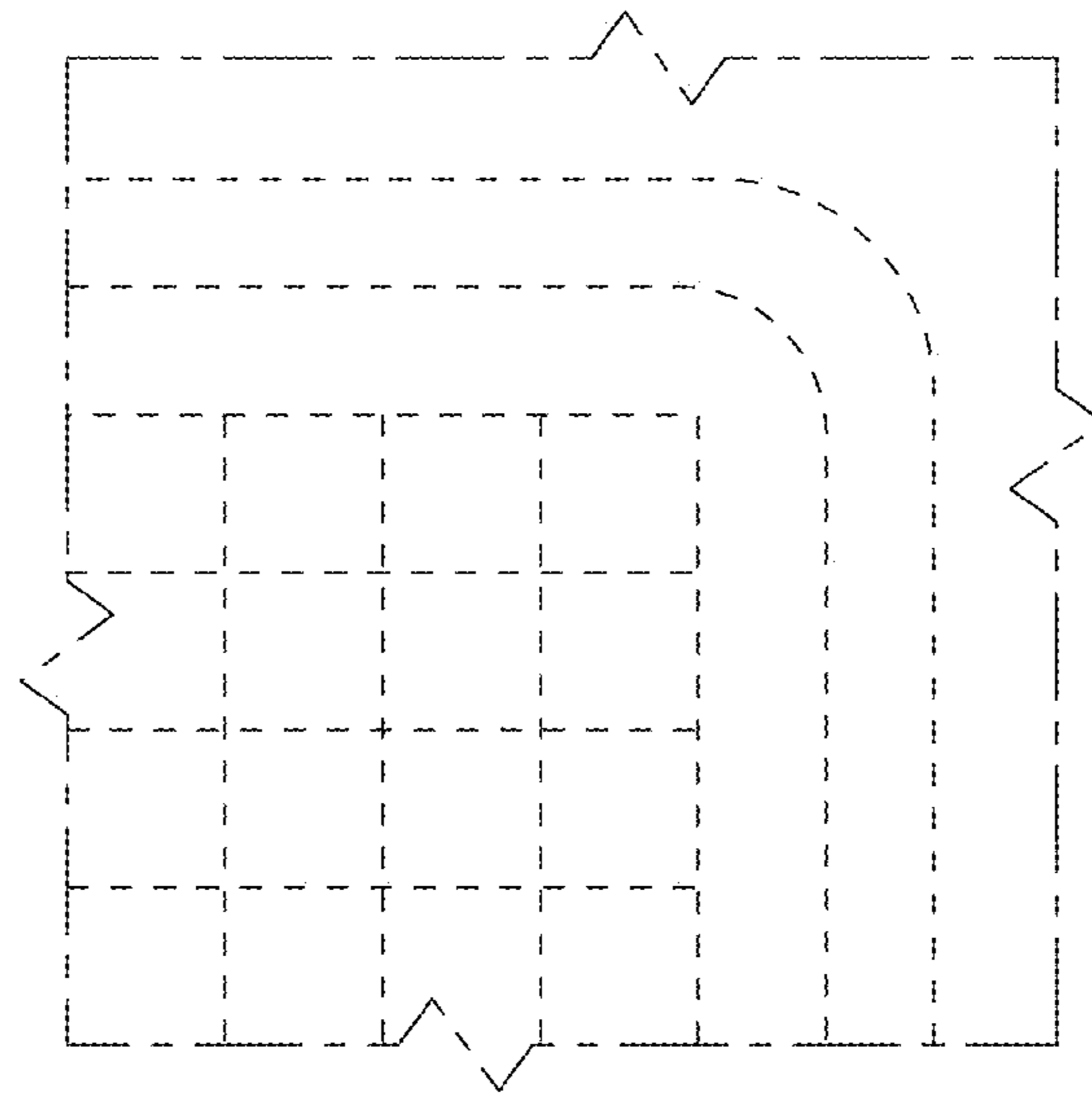

FIG. 42

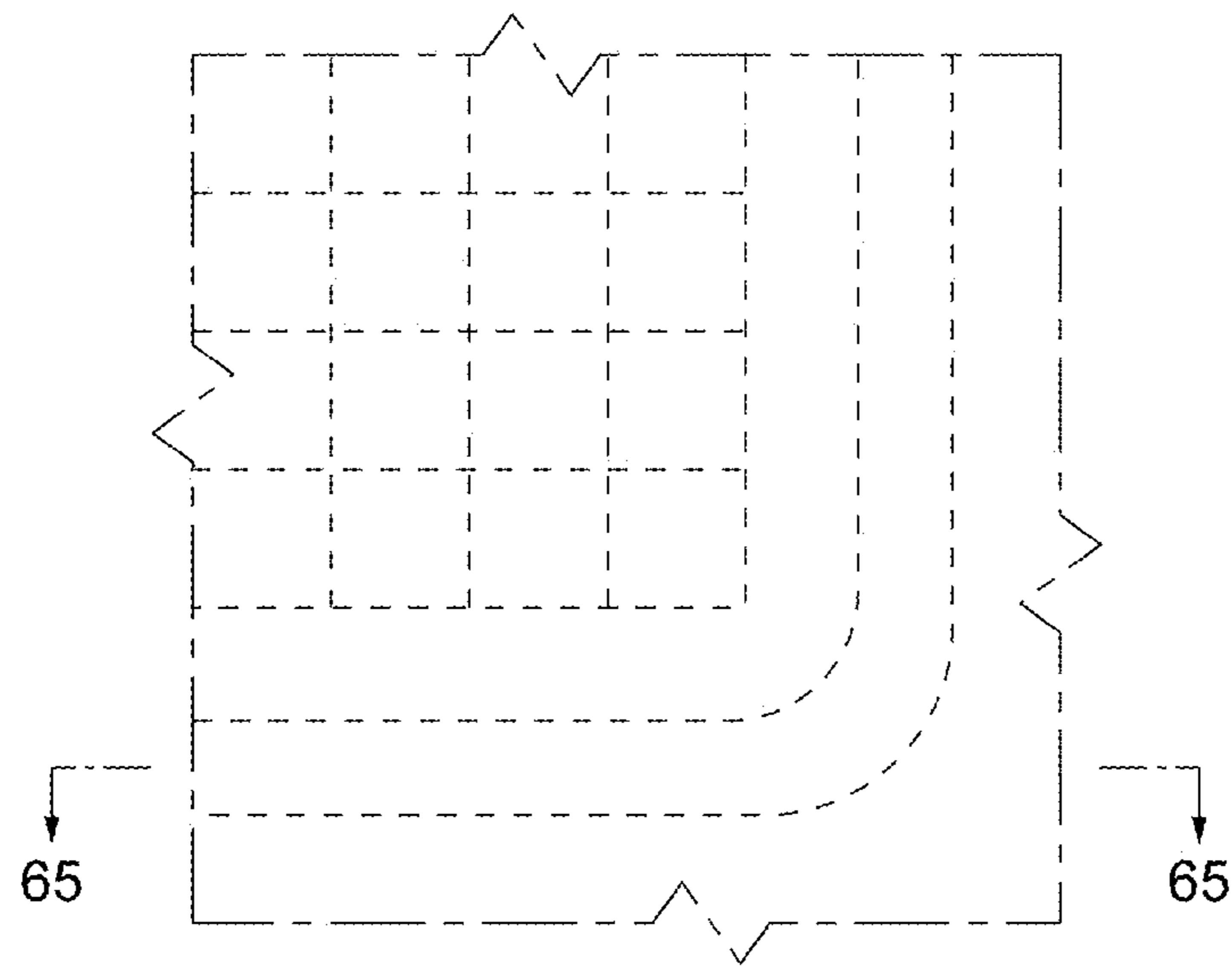

FIG. 44

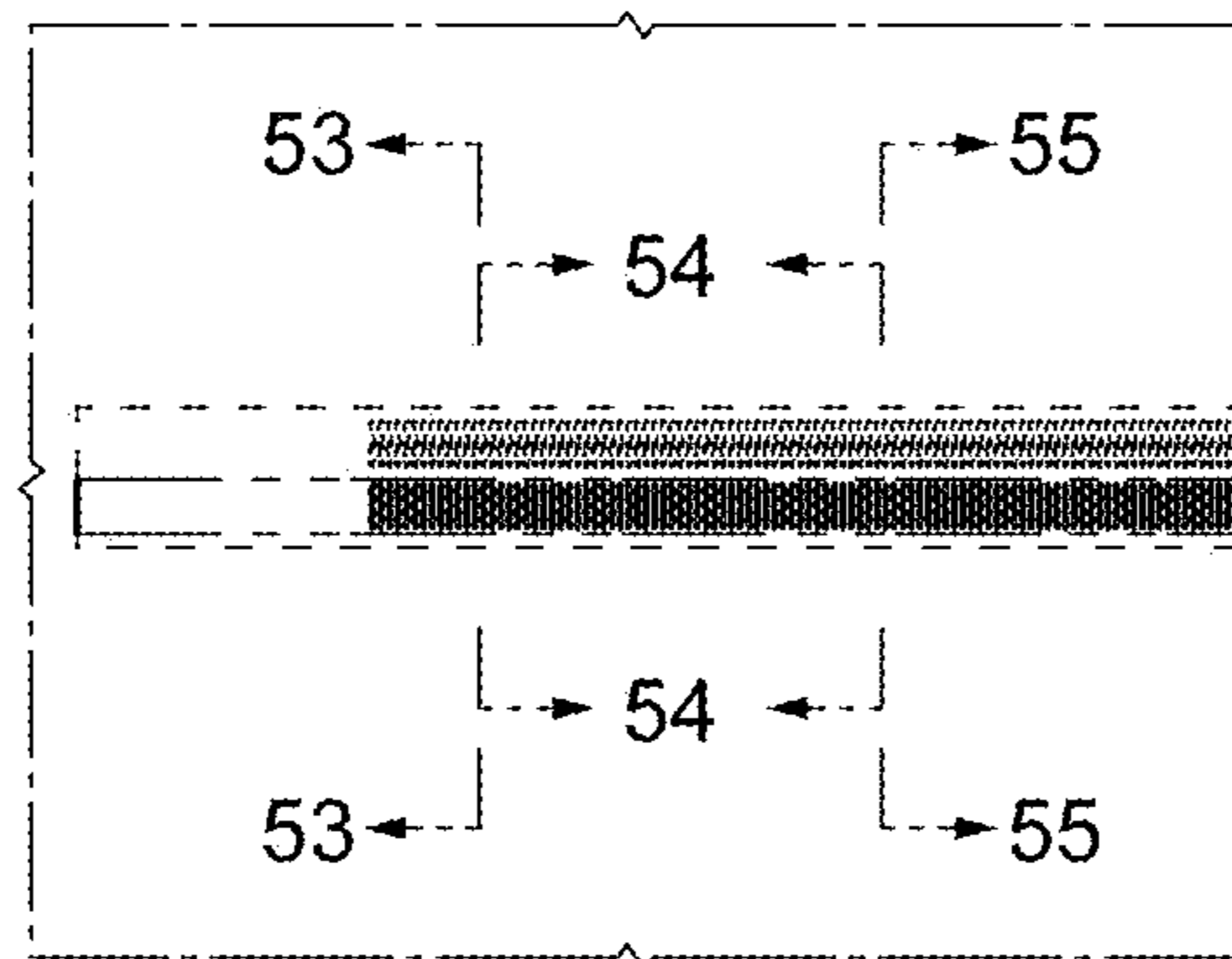

FIG. 45

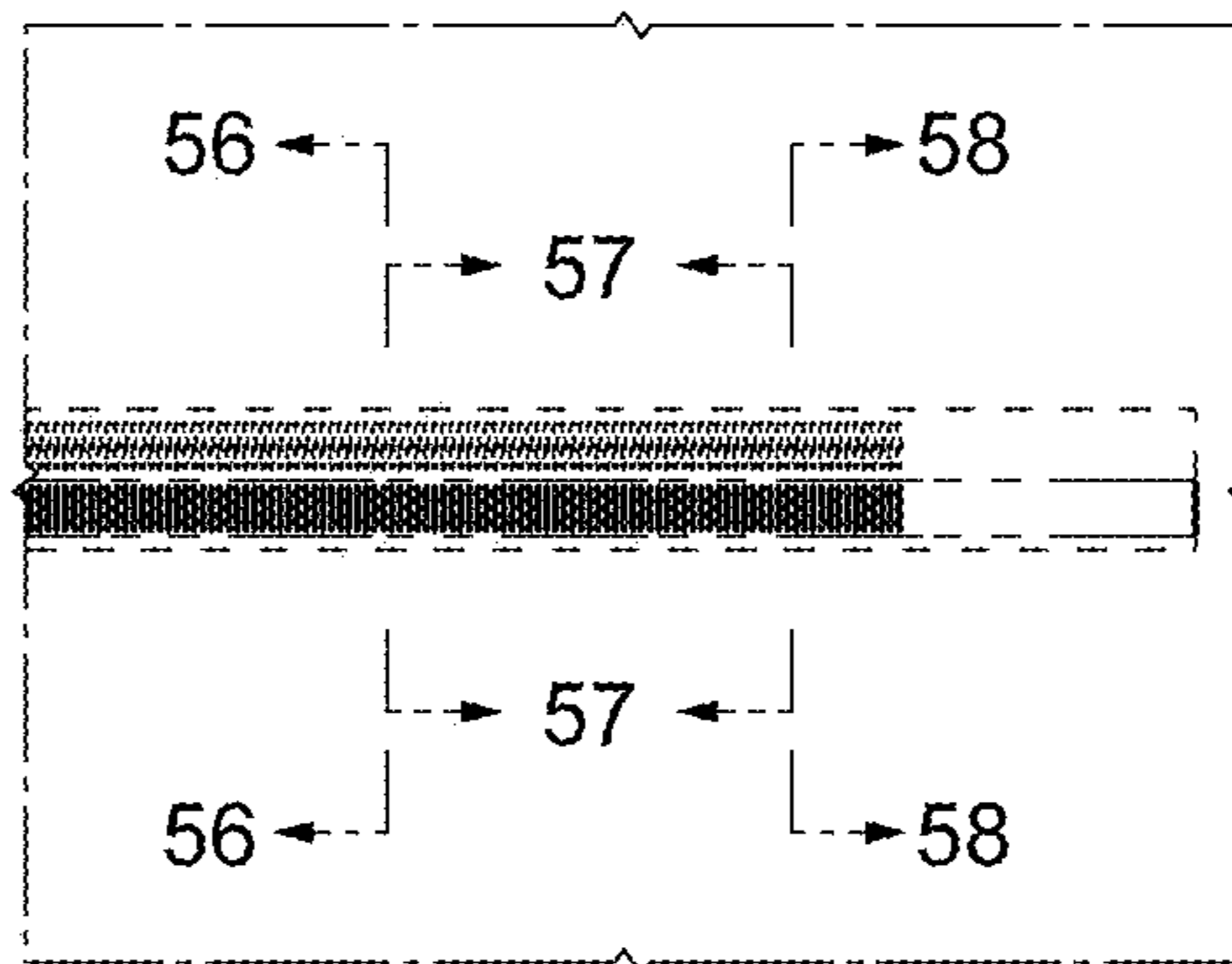

FIG. 46

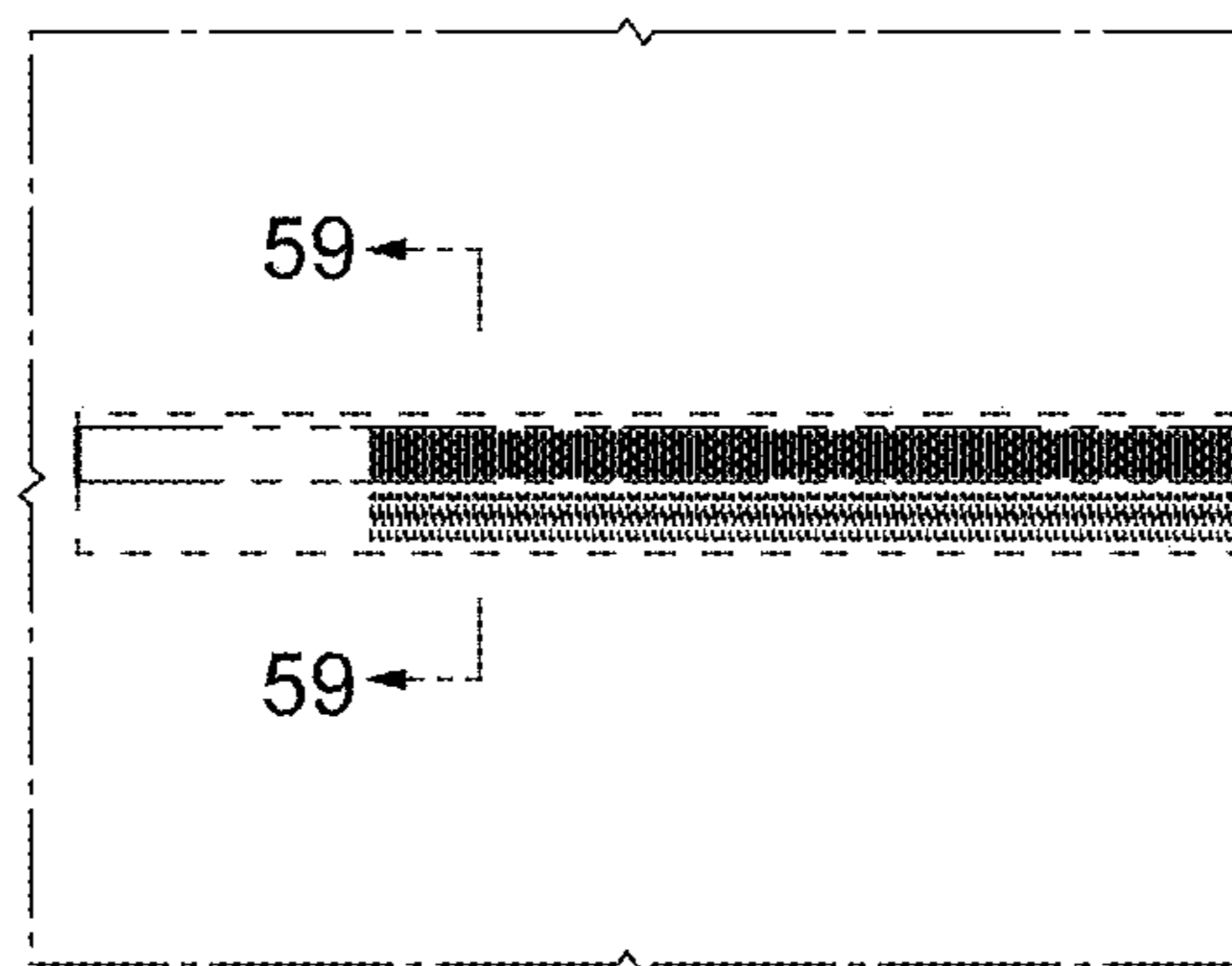

FIG. 47

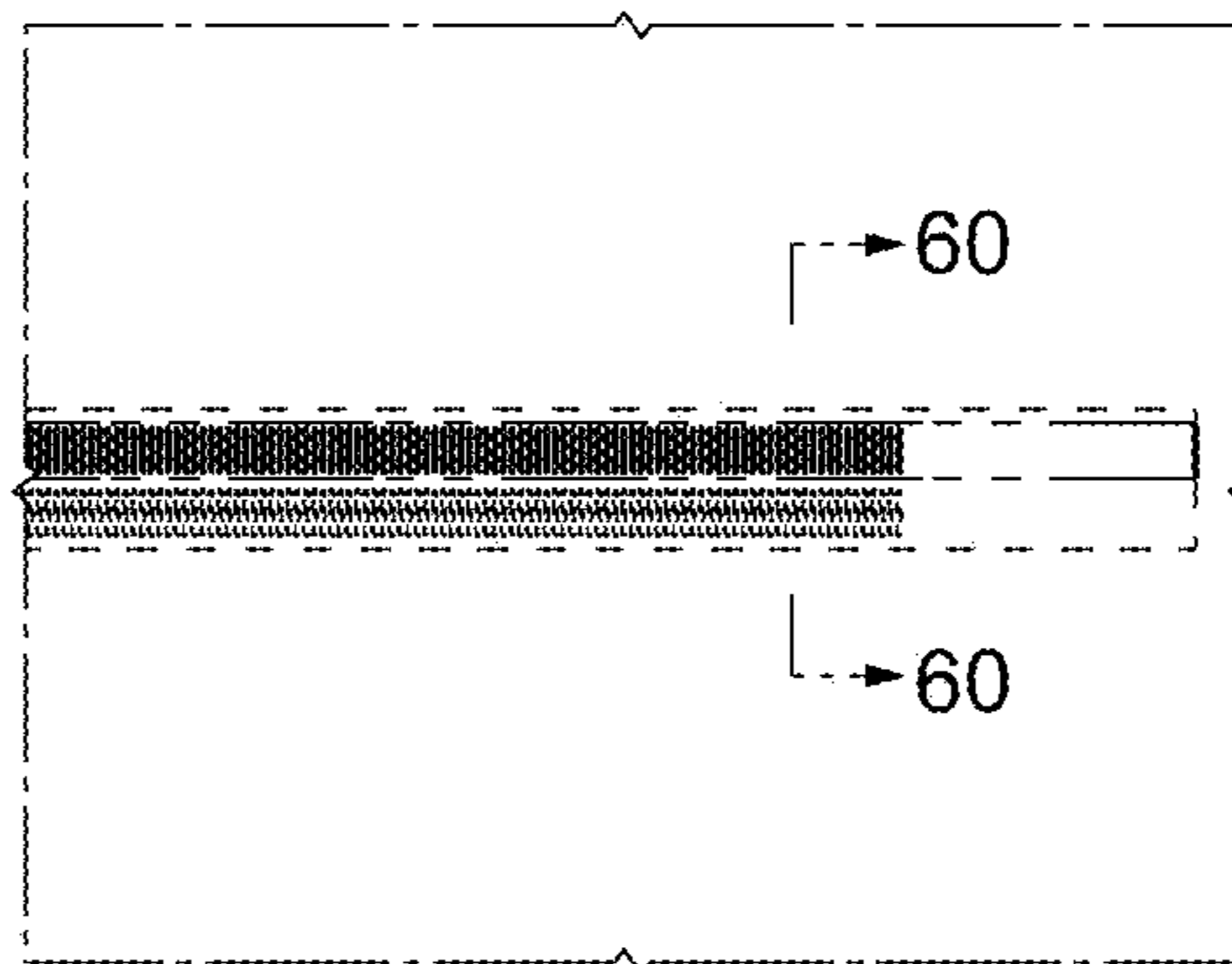

FIG. 48

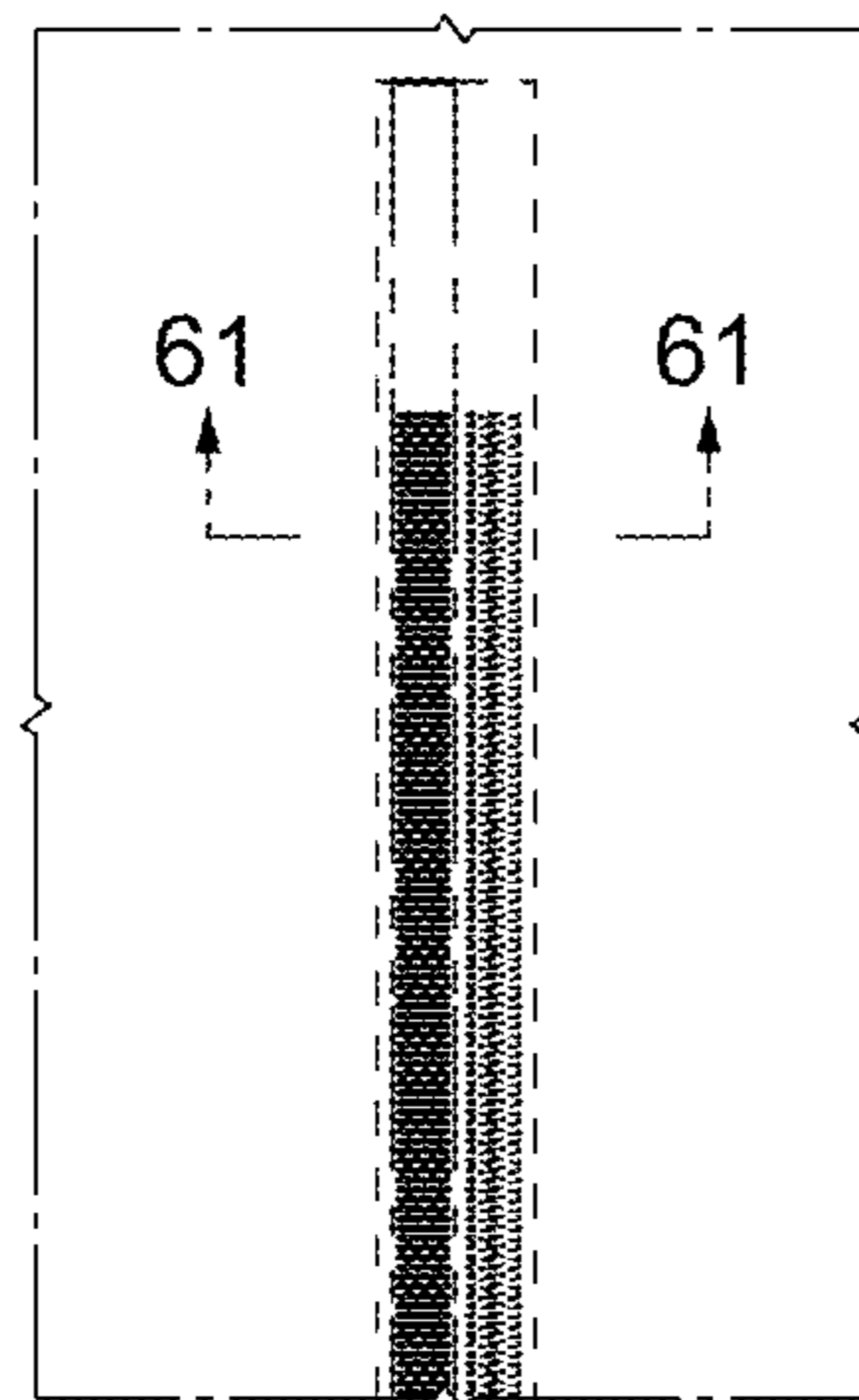

FIG. 49

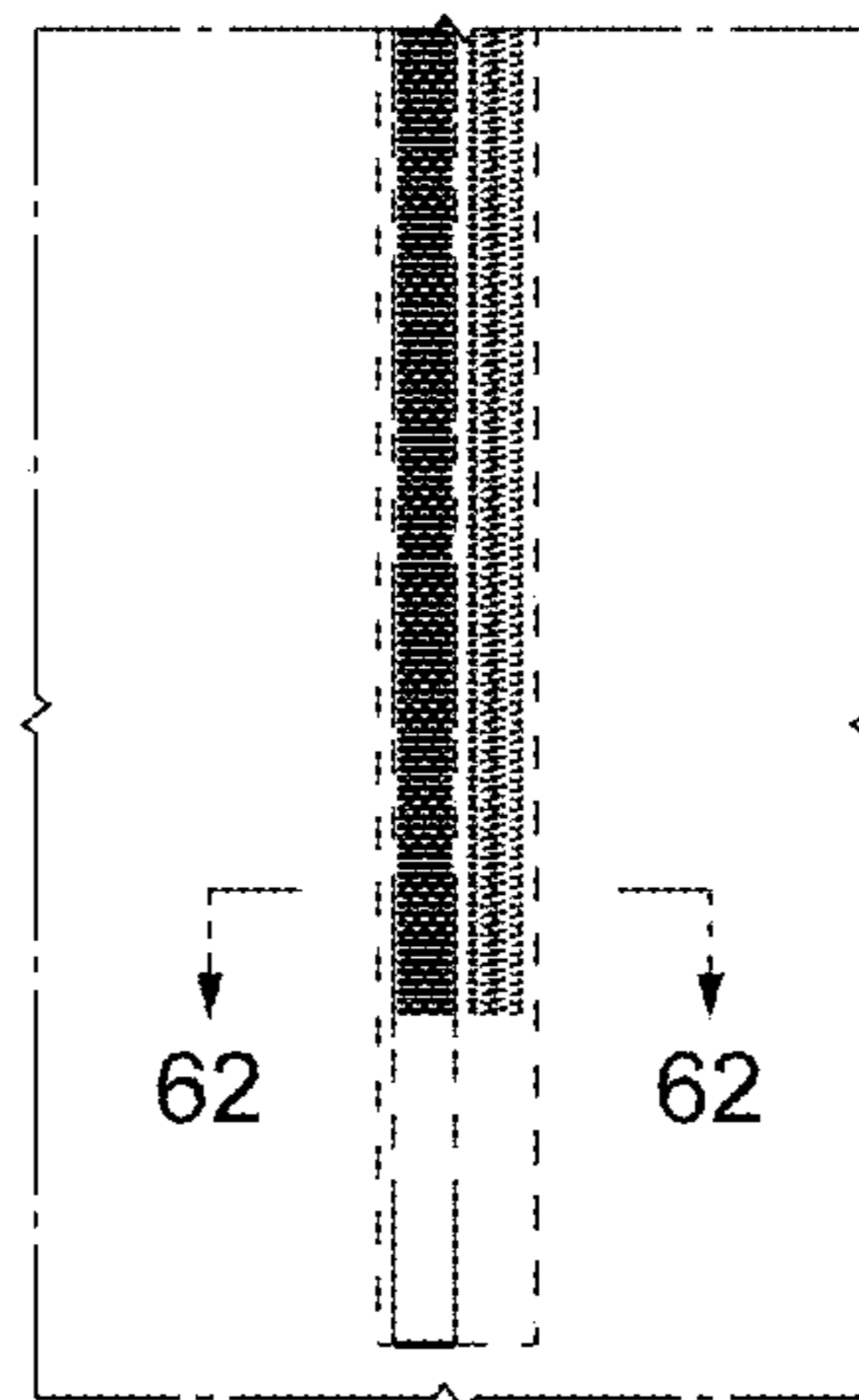

FIG. 50

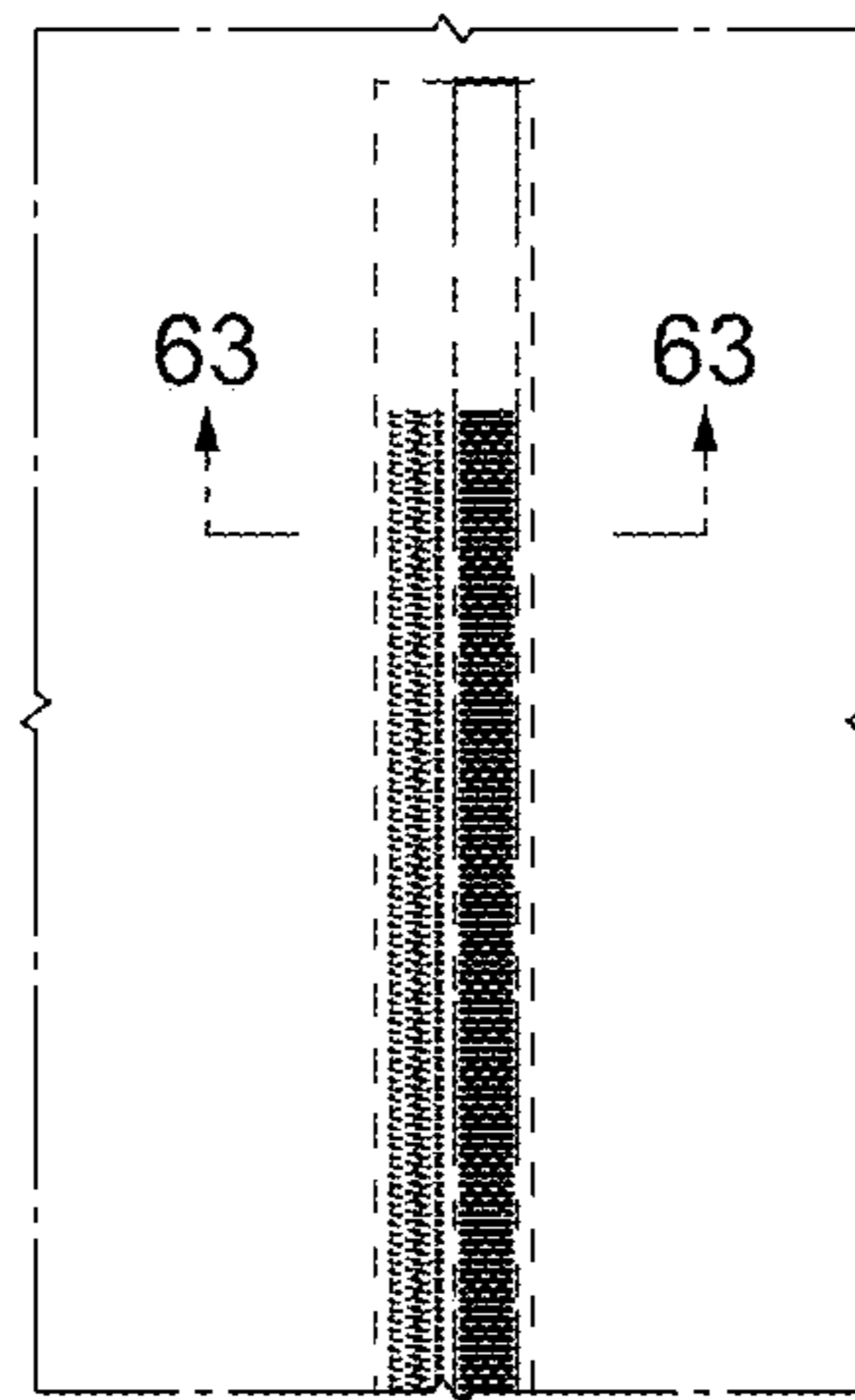

FIG. 51

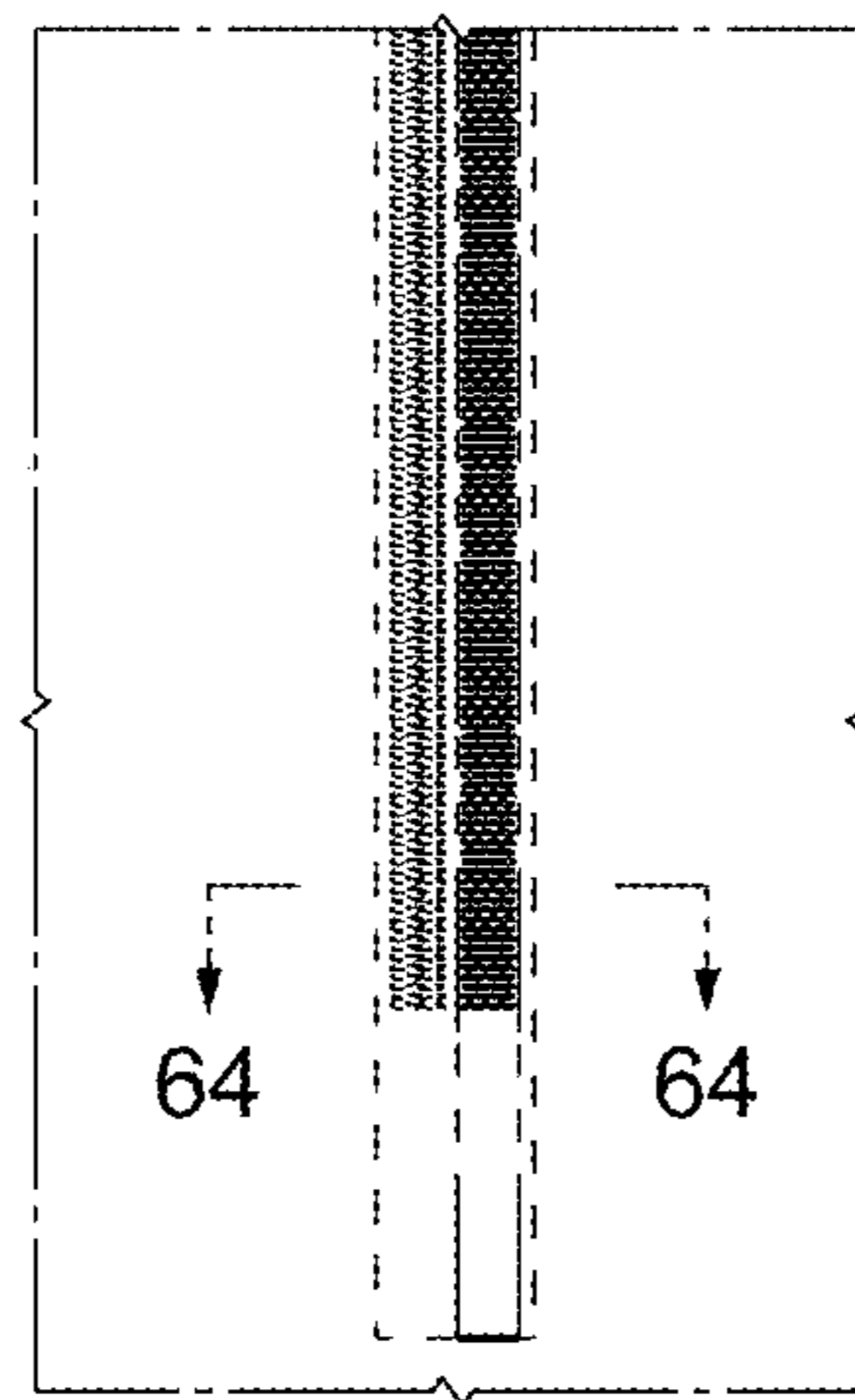

FIG. 52

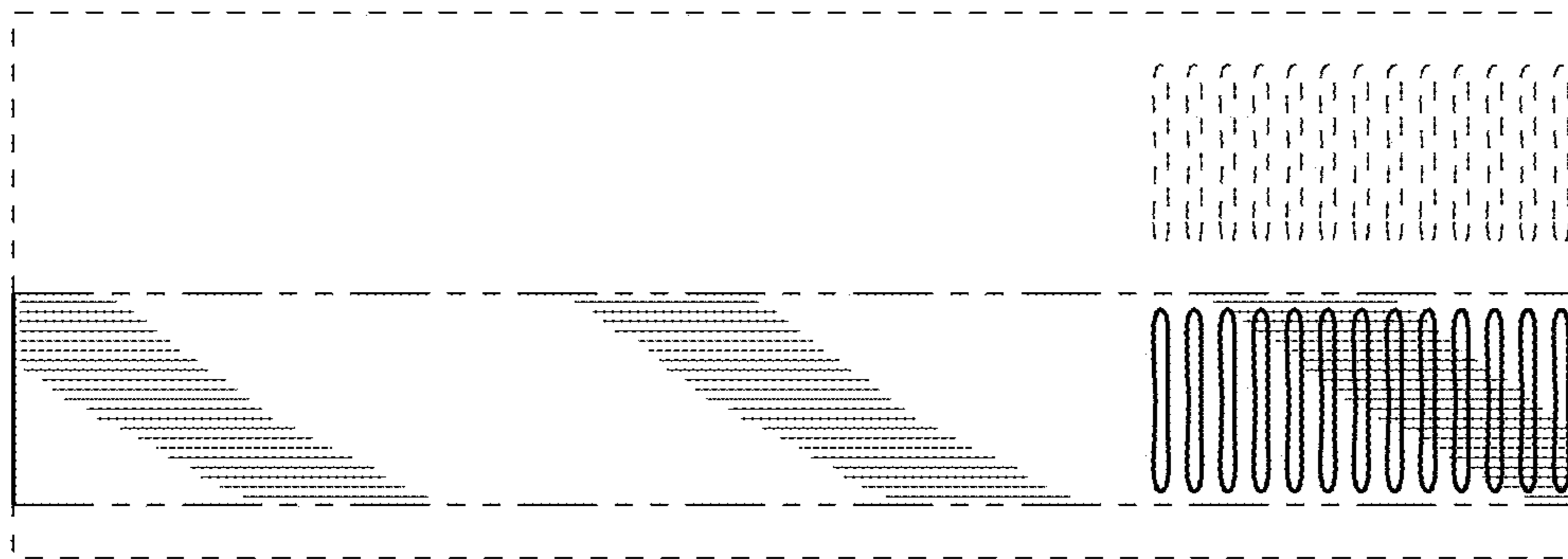

FIG. 53

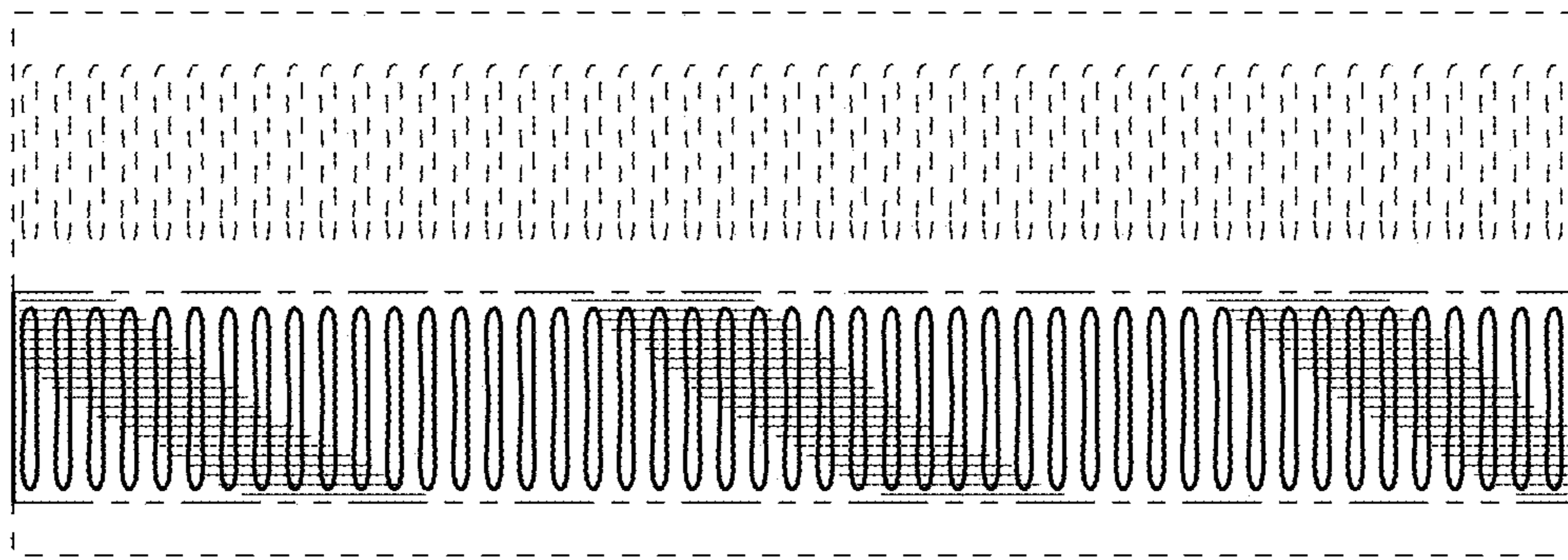

FIG. 54

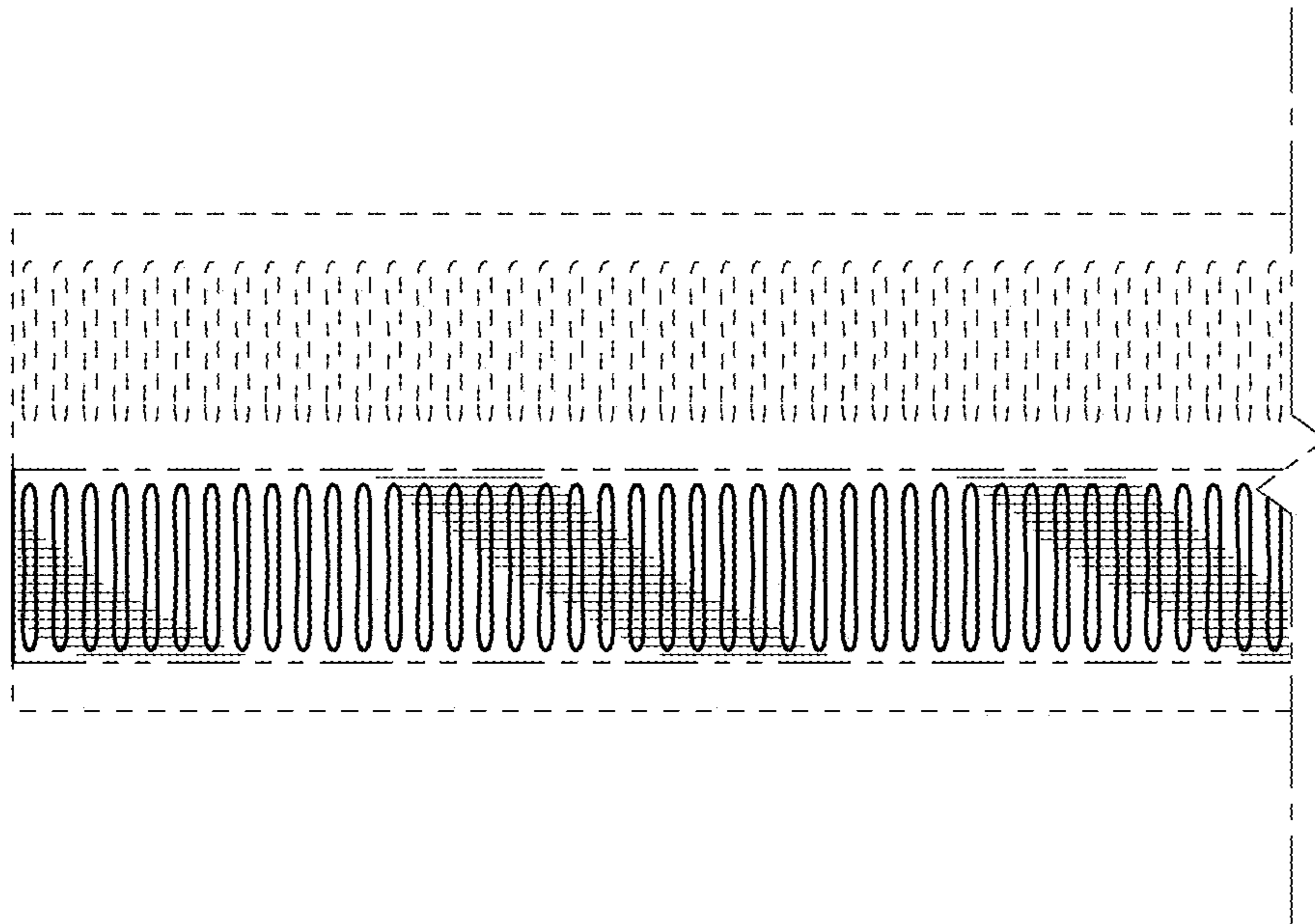

FIG. 55

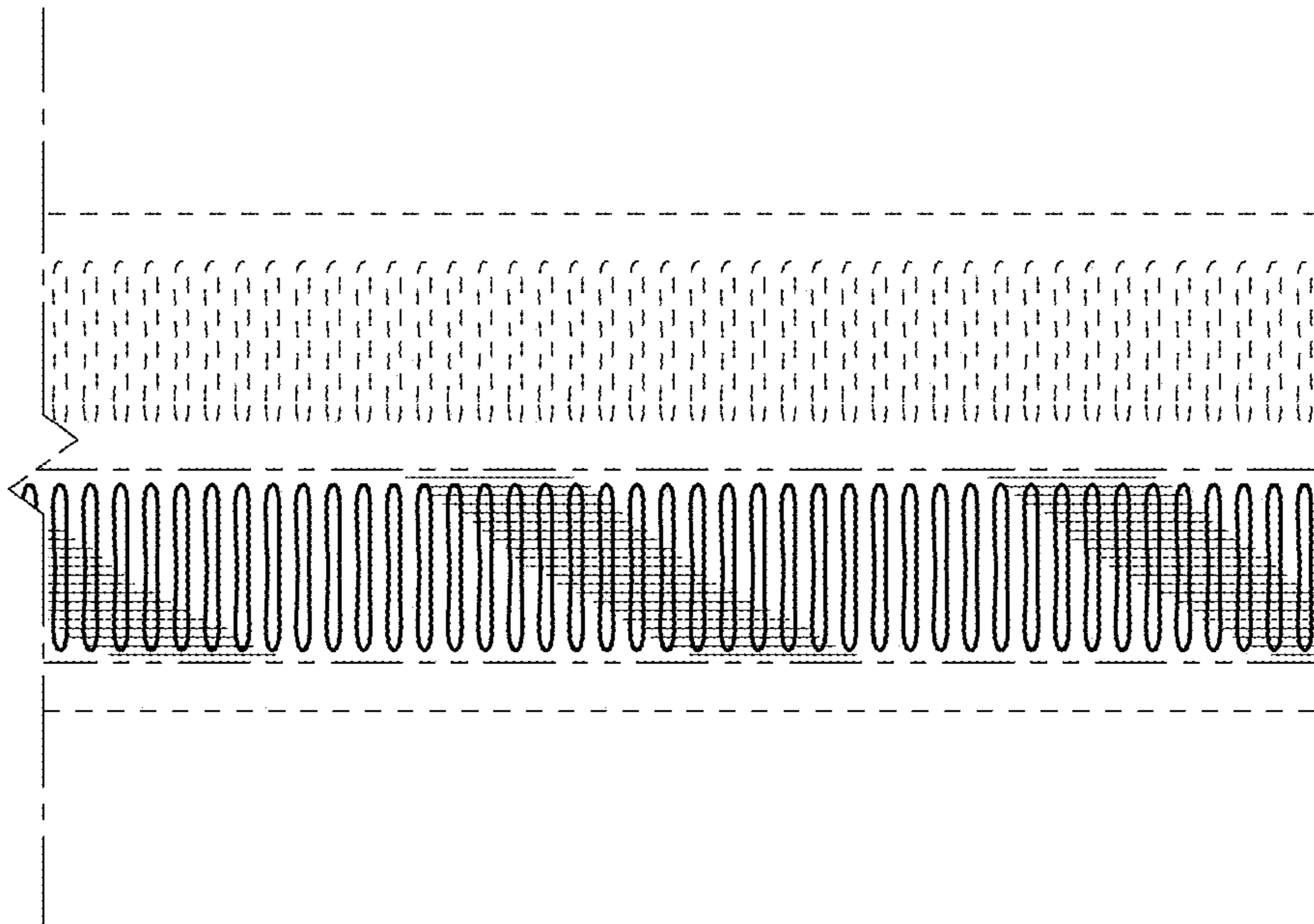

FIG. 56

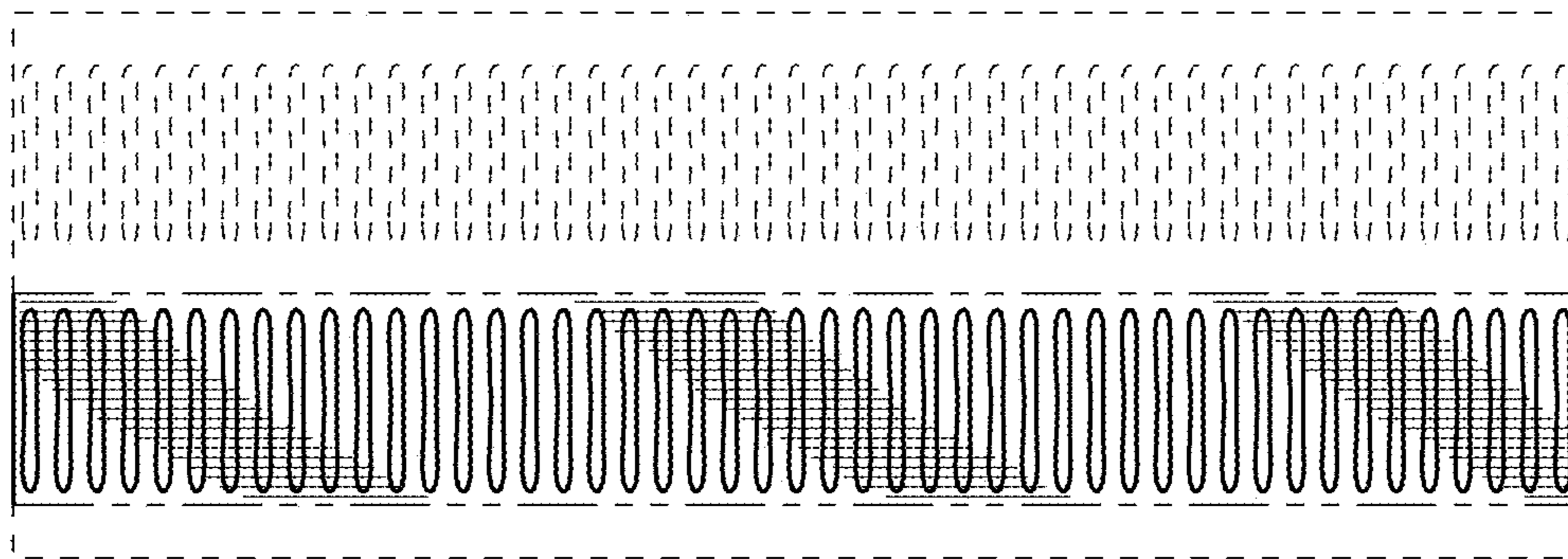

FIG. 57

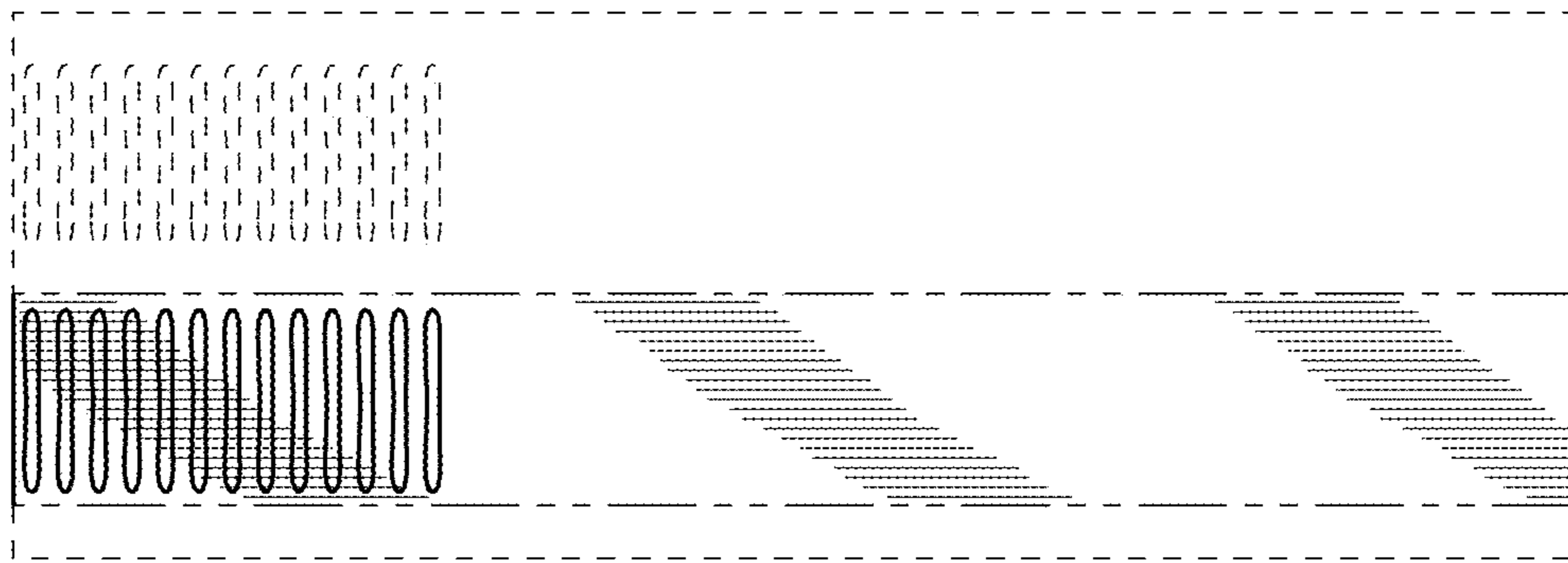

FIG. 58

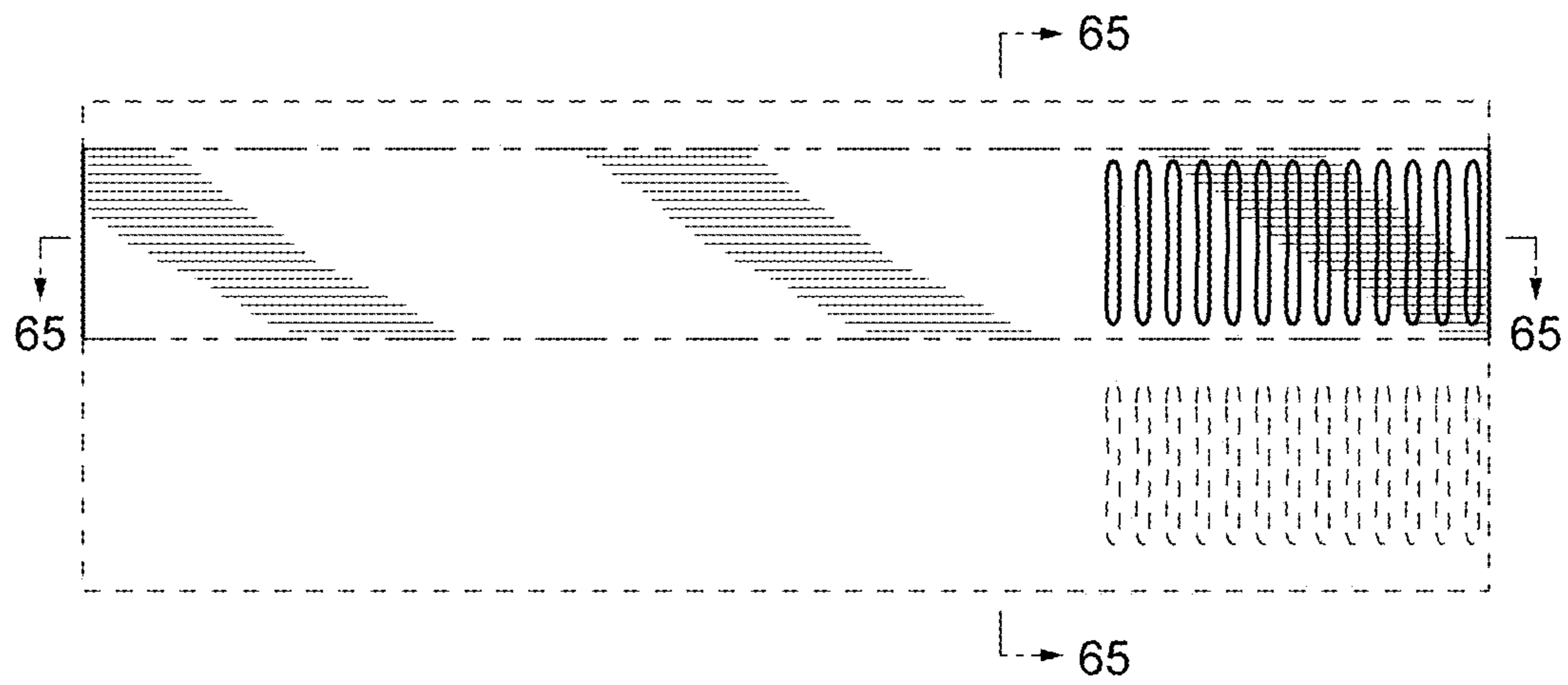

FIG. 59

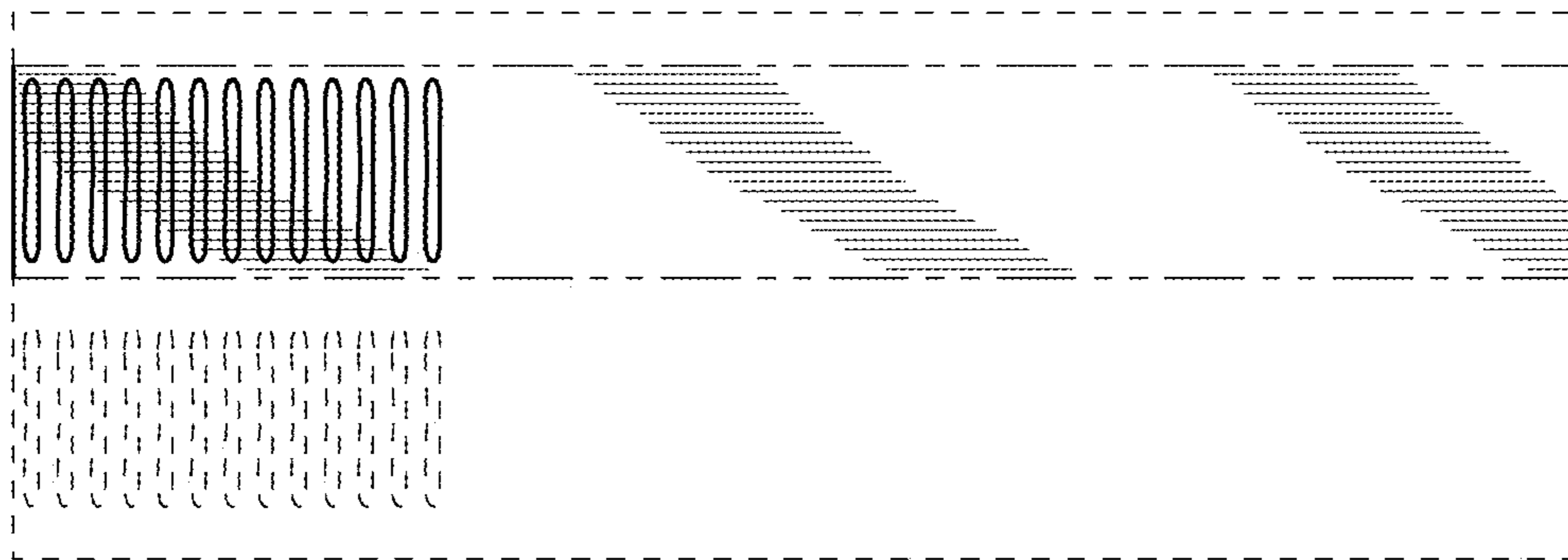

FIG. 60

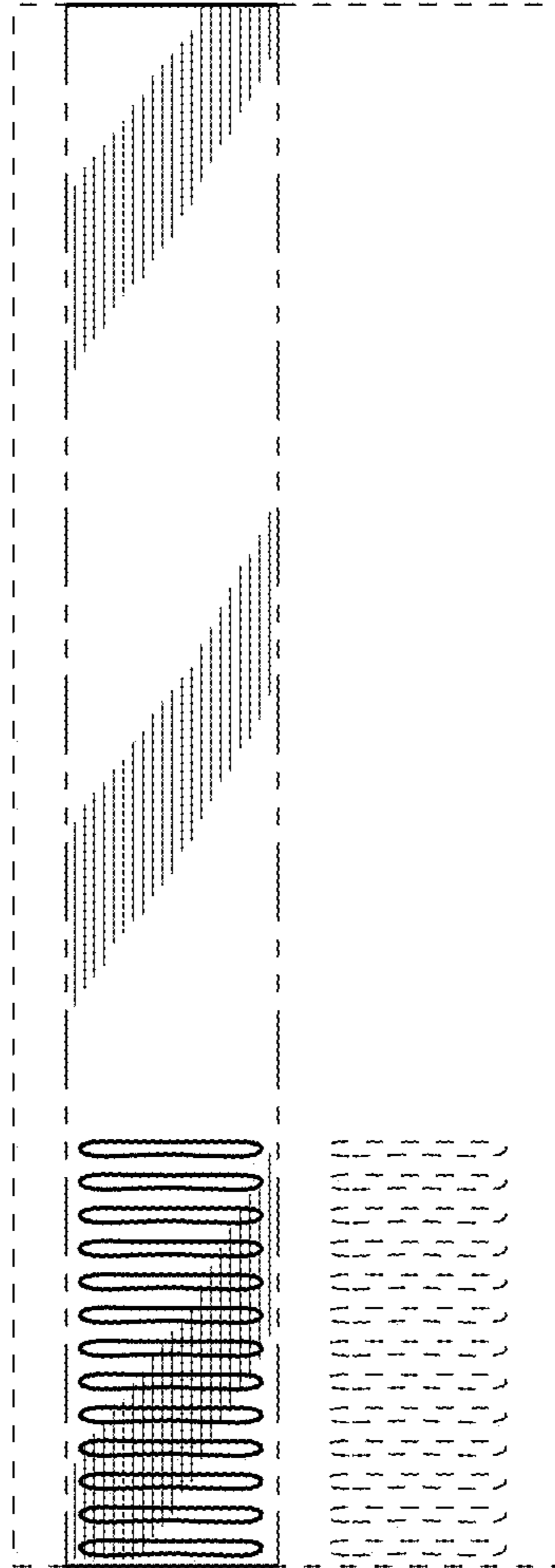

FIG. 61

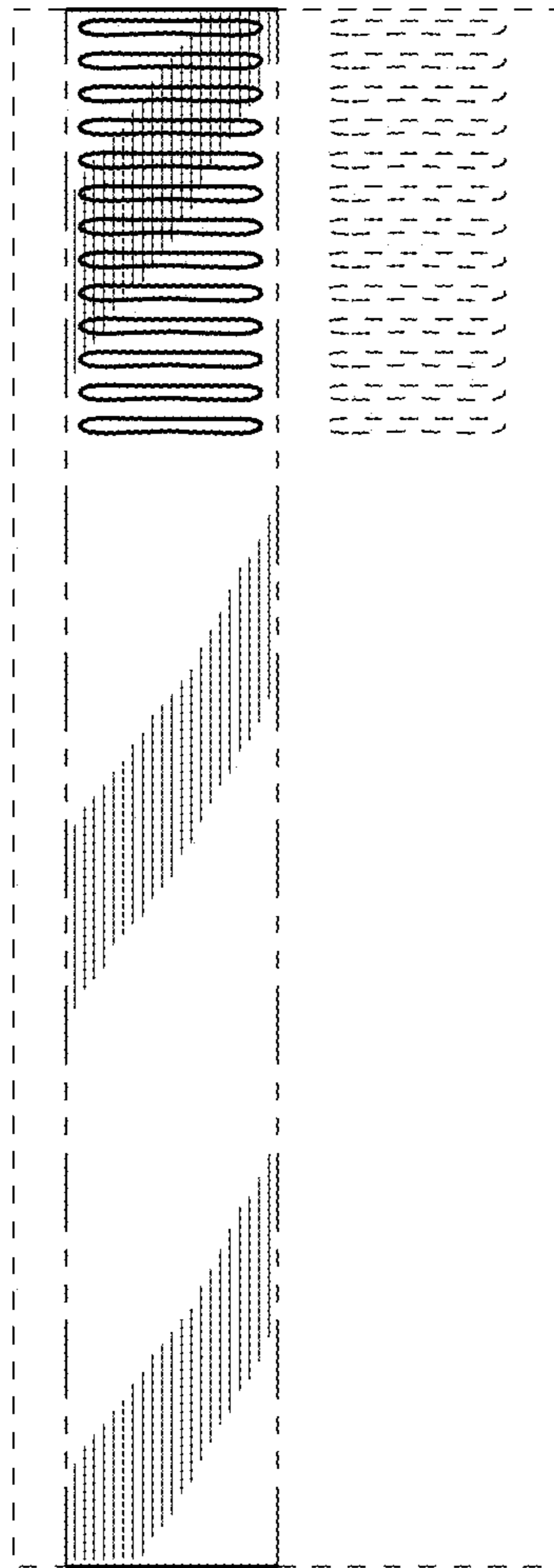

FIG. 62

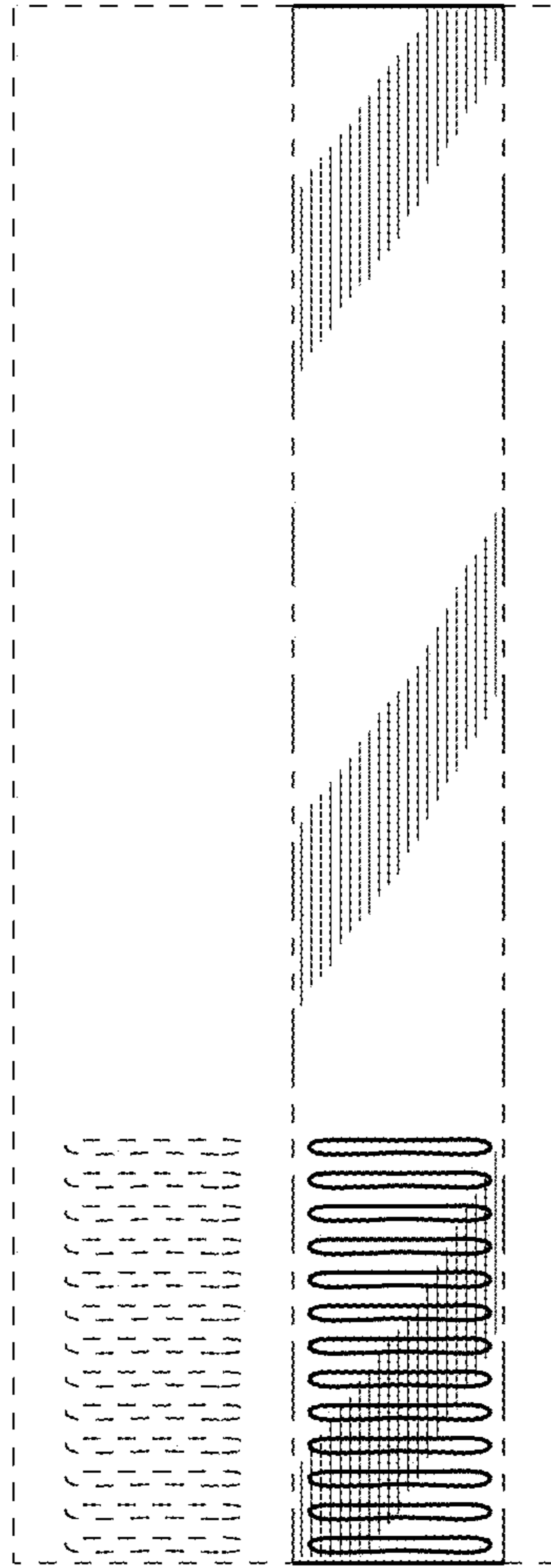

FIG. 63

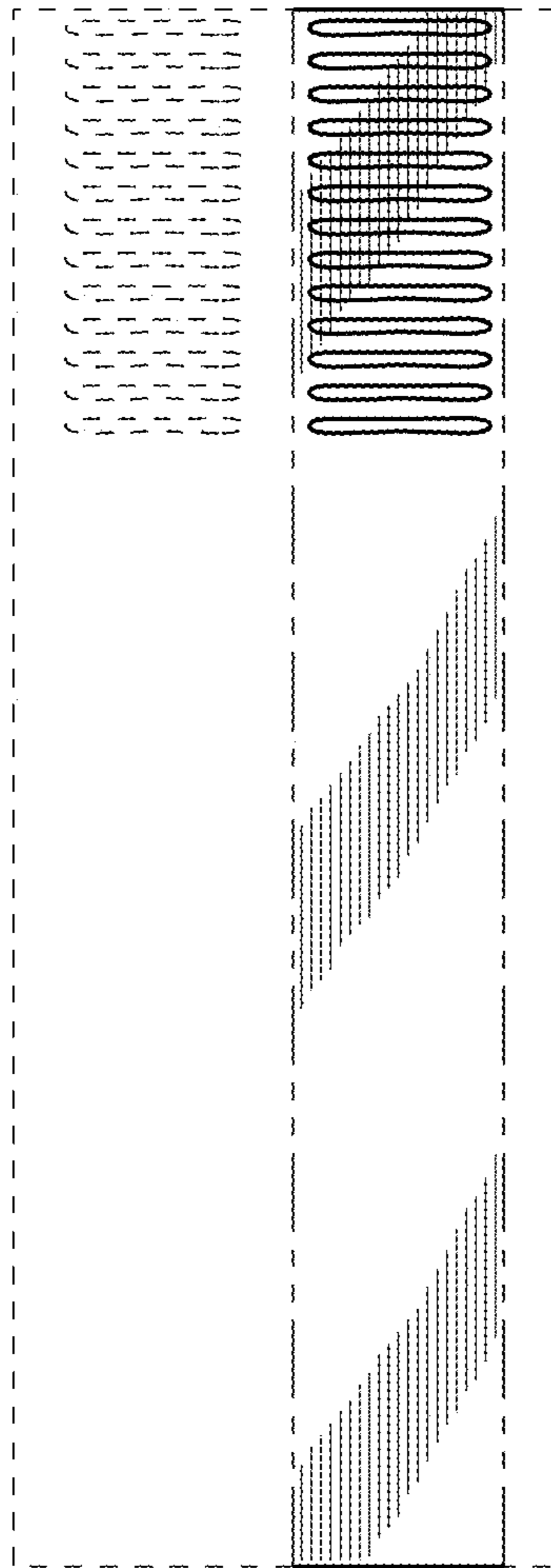

FIG. 64

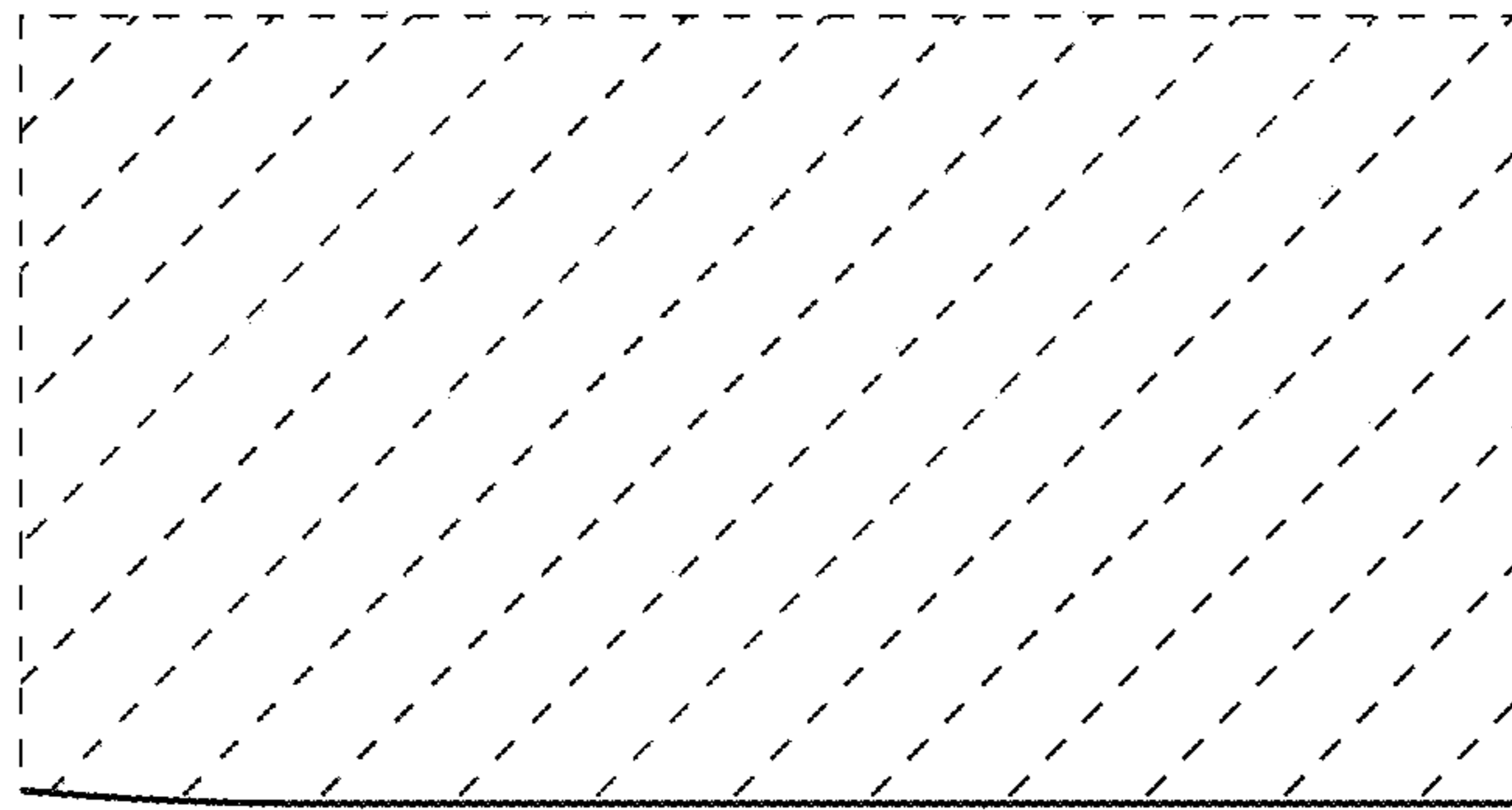

FIG. 65

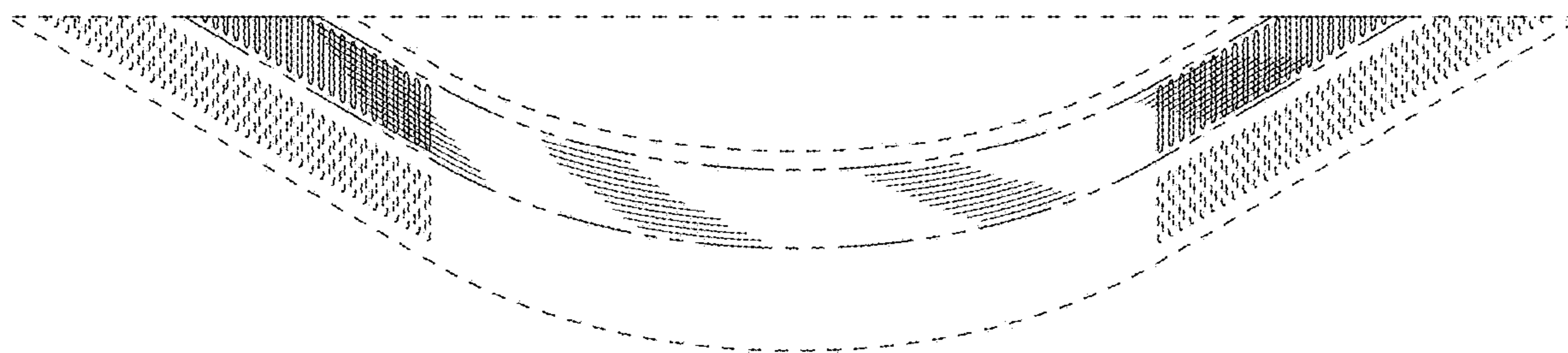

FIG. 66