



US00D884634S

(12) **United States Design Patent** (10) **Patent No.:** **US D884,634 S**
Kuwahara et al. (45) **Date of Patent:** **** May 19, 2020**

(54) **IMPELLER OF WATERWHEEL**
(71) Applicant: **ELIS CO., LTD.**, Okayama (JP)
(72) Inventors: **Jun Kuwahara**, Okayama (JP); **Soichi Sasaki**, Nagasaki (JP); **Yuichiro Oya**, Nagasaki (JP)
(73) Assignee: **ELIS CO., LTD.**, Okayama (JP)

D716,228 S * 10/2014 McCamley D13/115
9,206,784 B2 * 12/2015 Alfonsi F01D 1/14
D761,881 S * 7/2016 Small D15/28
2004/0036297 A1 * 2/2004 John F03D 3/0409
290/55
2012/0061970 A1 * 3/2012 Zivkovich F03D 1/04
290/55
2012/0139251 A1 * 6/2012 Pai F03B 17/067
290/54
2018/0066632 A1 * 3/2018 Chung F03D 13/20

(**) Term: **15 Years**

FOREIGN PATENT DOCUMENTS

(21) Appl. No.: **29/645,421**

JP D1514101 12/2014

(22) Filed: **Apr. 26, 2018**

* cited by examiner

(30) **Foreign Application Priority Data**

Primary Examiner — Derrick E Holland

Oct. 30, 2017 (JP) 2017-024128

(74) *Attorney, Agent, or Firm* — Pearne & Gordon LLP

(51) **LOC (12) Cl.** **13-01**

(57) **CLAIM**

(52) **U.S. Cl.**

The ornamental design for an impeller of waterwheel, as shown and described.

USPC **D13/122**

(58) **Field of Classification Search**

DESCRIPTION

USPC D13/101, 102, 112, 113, 114, 115, 118,
D13/122, 173, 175, 184, 199; D15/5, 7,
D15/28; D23/379, 411; D10/59
CPC G09B 23/08; G09B 23/12; F03D 3/0409;
F03D 3/0427; F03D 3/005; F03D 3/067;
F03D 1/00; F03D 1/04; F03B 7/00; F03B
17/06; F03B 17/065; H02K 7/183
See application file for complete search history.

FIG. 1 is a front view of an impeller of waterwheel showing our new design;
FIG. 2 is a rear view thereof;
FIG. 3 is a left side view thereof;
FIG. 4 is a right side view thereof;
FIG. 5 is a top view thereof;
FIG. 6 is a bottom view thereof;
FIG. 7 is a cross-sectional view thereof taken along section line 7-7 of FIG. 1;
FIG. 8 is a cross-sectional view thereof taken along section line 8-8 of FIG. 5;
FIG. 9 is a perspective view thereof; and,
FIG. 10 is a partially enlarged perspective view of portion 10 of FIG. 9.
The dot-dash broken lines shown define the bounds of the claimed design and form no part thereof.

(56) **References Cited**

U.S. PATENT DOCUMENTS

5,049,080 A * 9/1991 Kriebel G09B 23/08
434/126
D511,323 S * 11/2005 Kato D13/115
D533,935 S * 12/2006 Chen D23/411
D616,468 S * 5/2010 Bossom D15/7
8,210,817 B2 * 7/2012 Iskrenovic F03D 1/00
416/197 A
D699,835 S * 2/2014 Kenyon D23/413

1 Claim, 10 Drawing Sheets

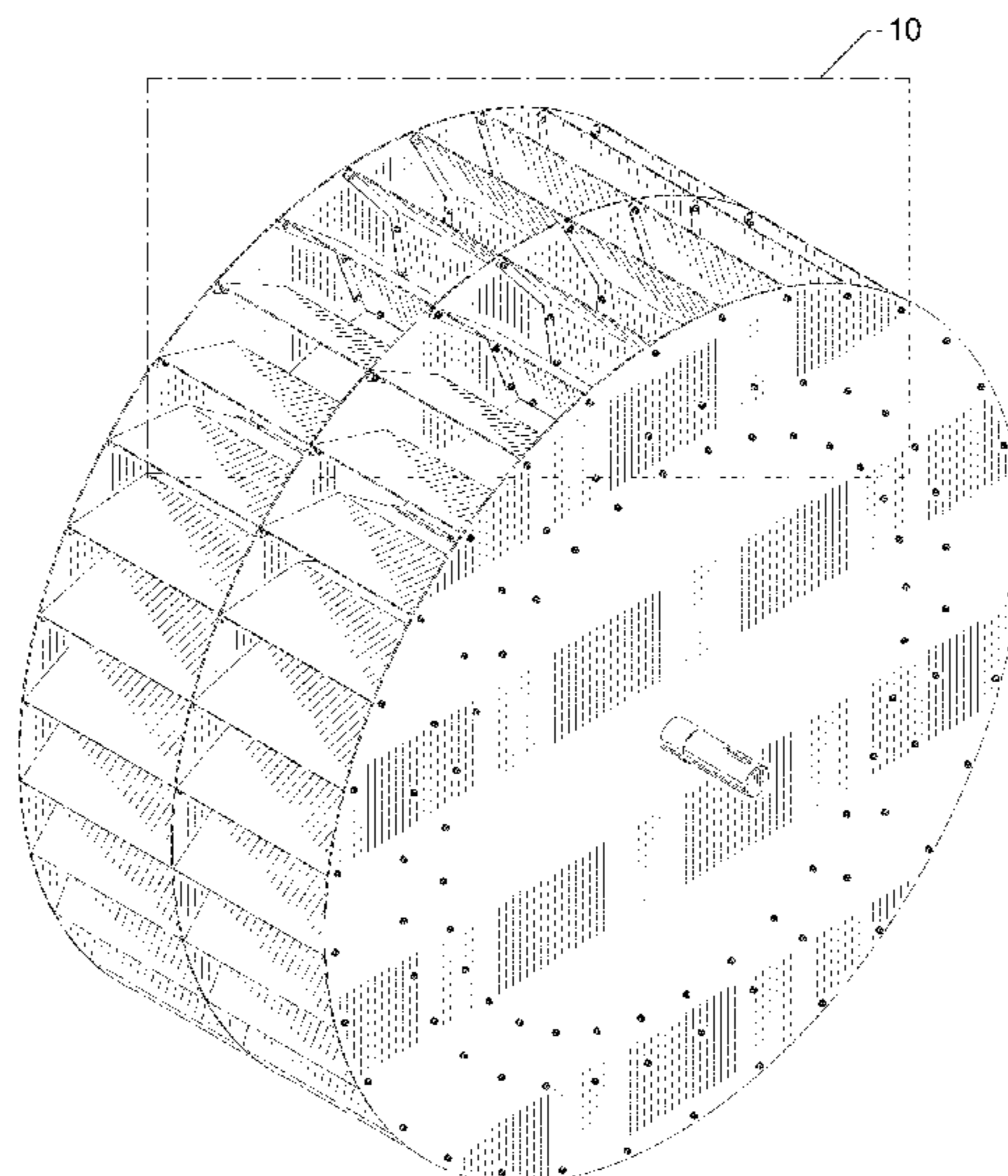

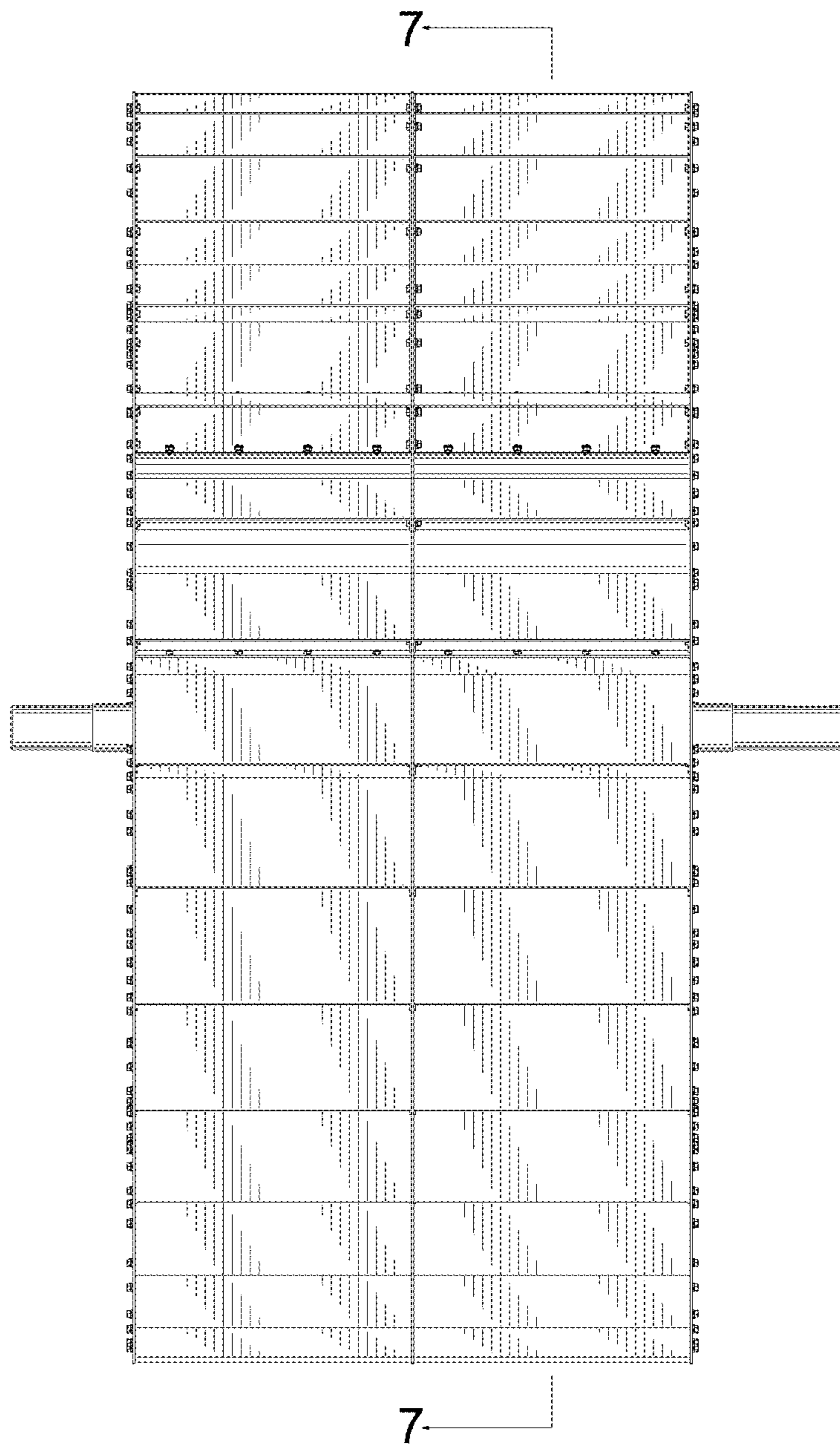

FIG. 1

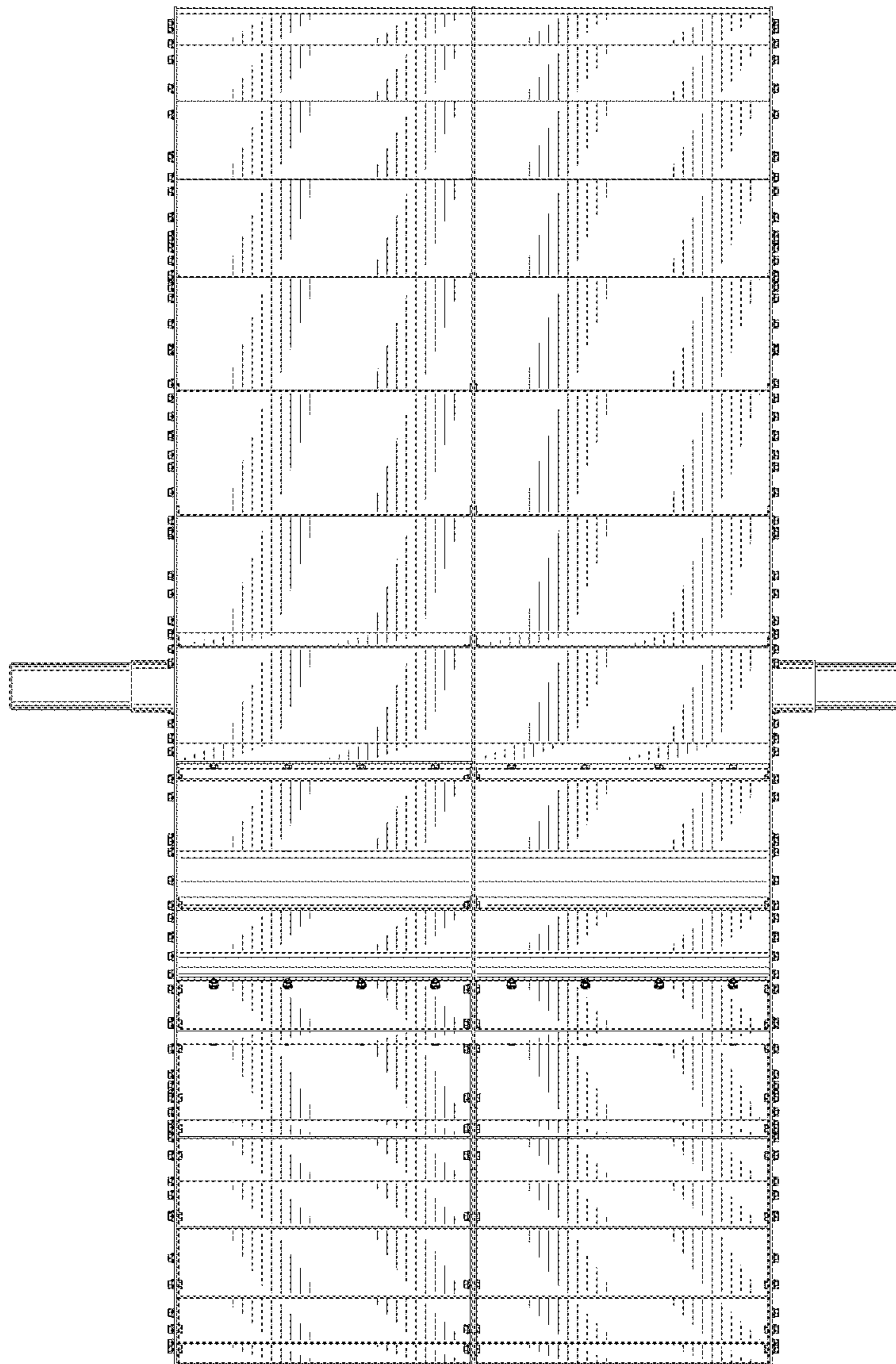

FIG. 2

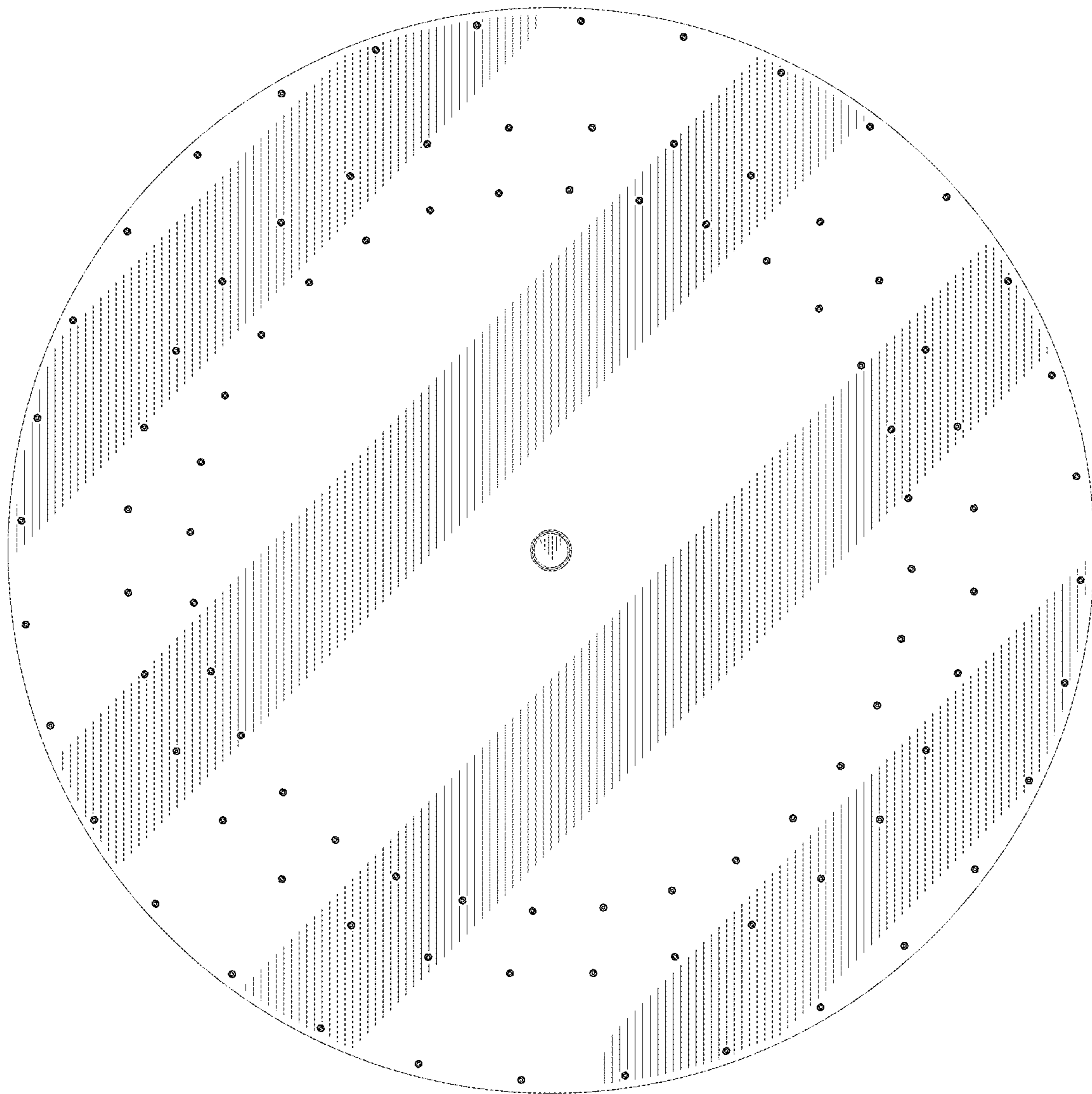

FIG. 3

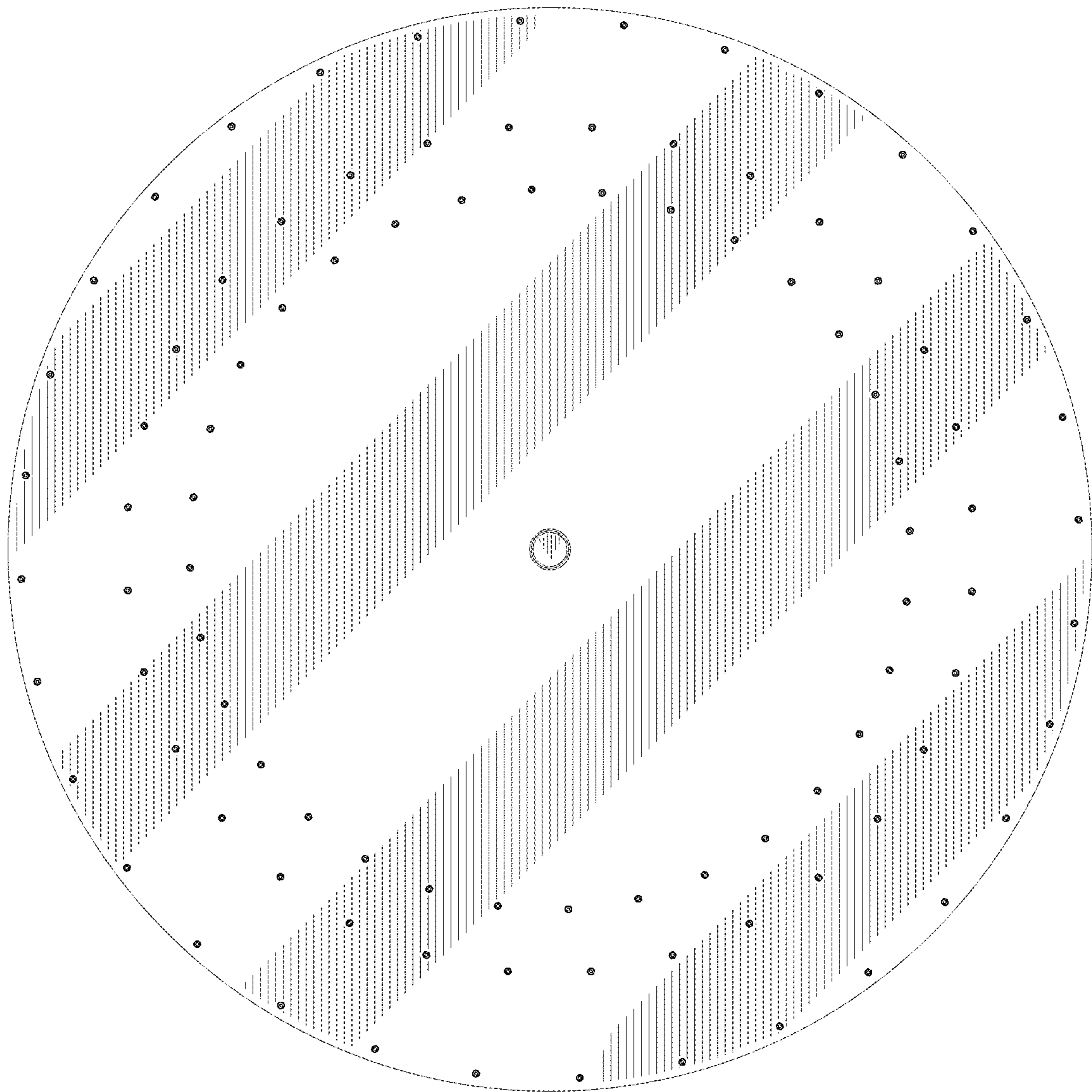

FIG. 4

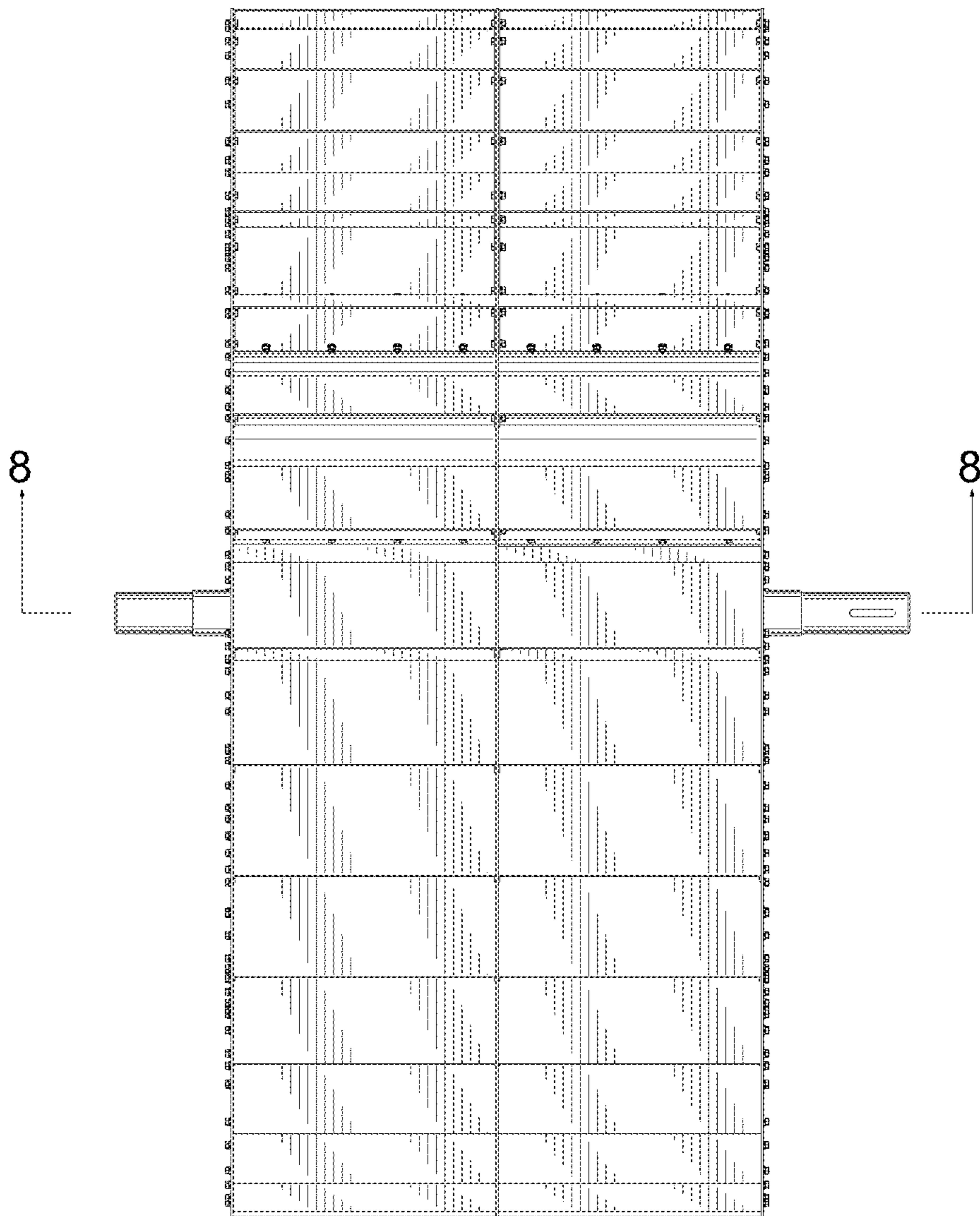

FIG. 5

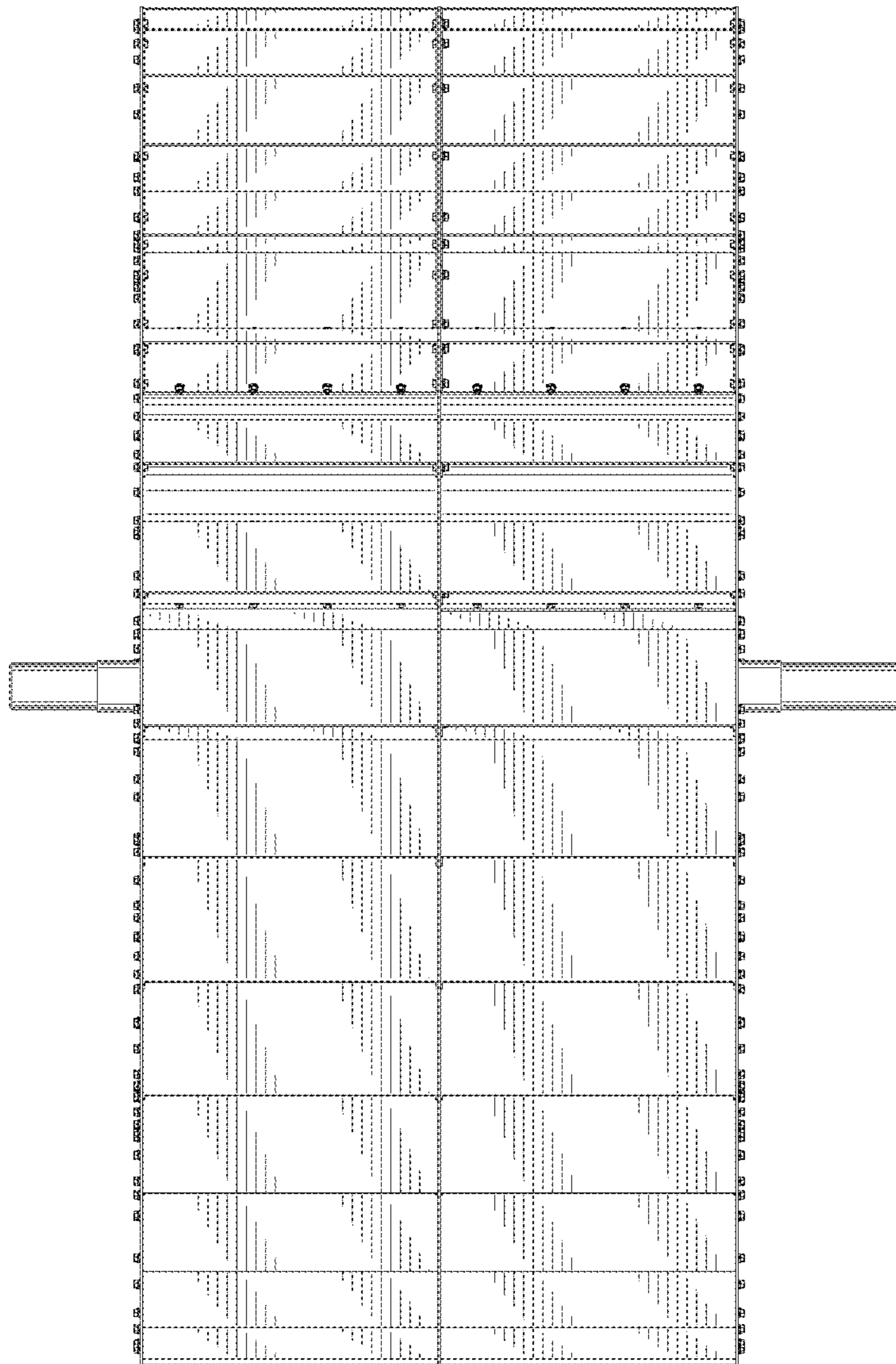

FIG. 6

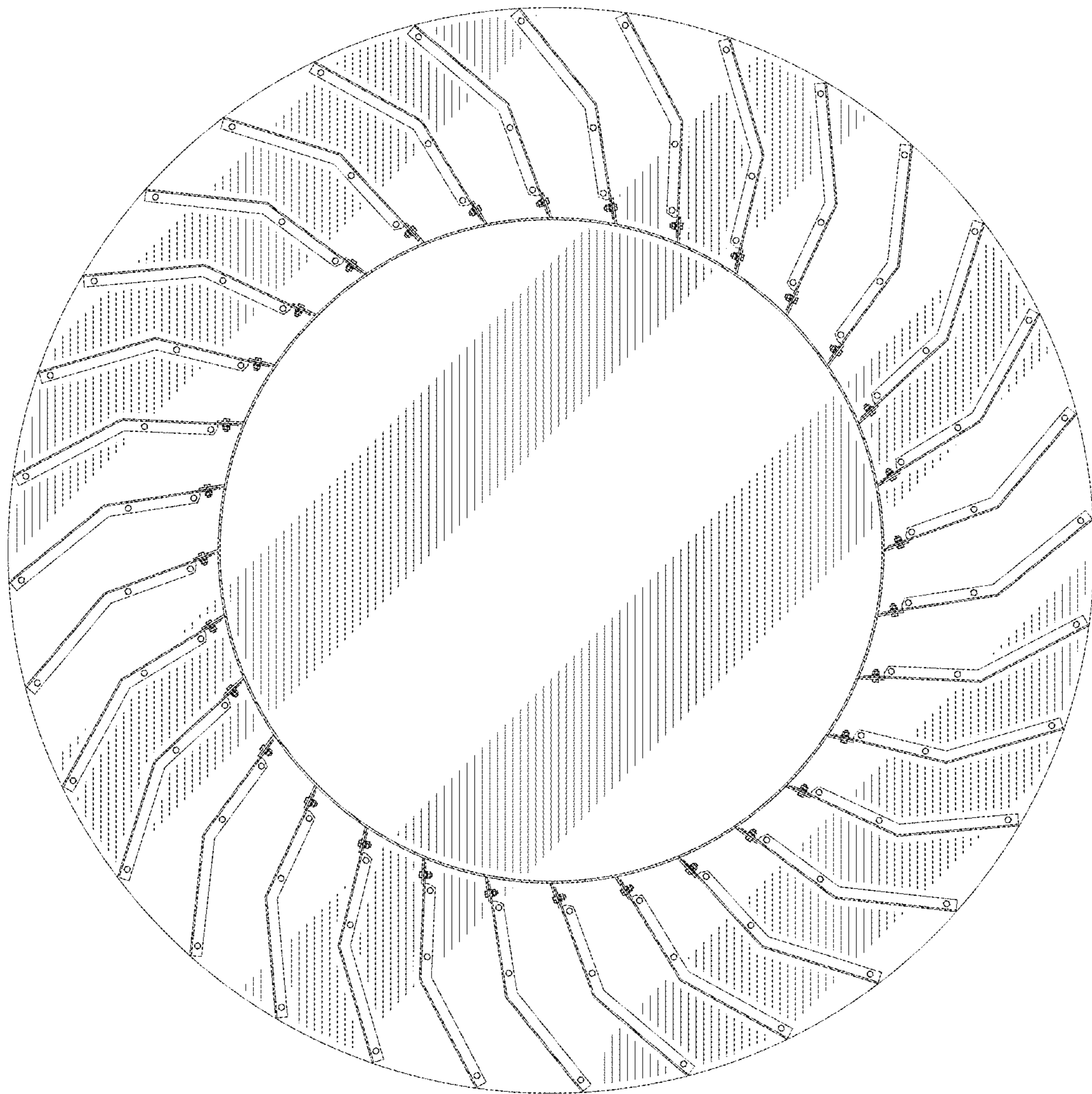

FIG. 7

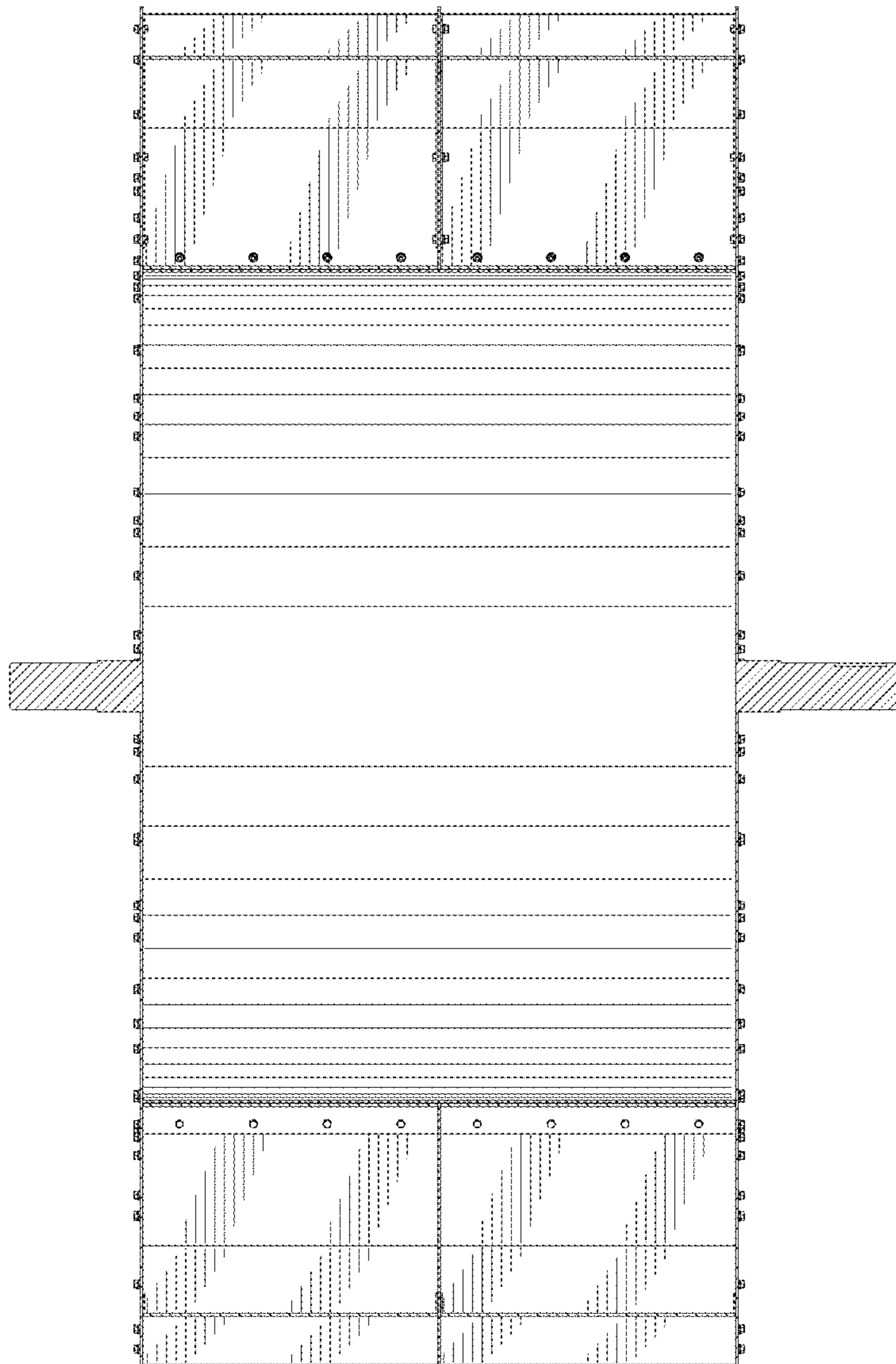

FIG. 8

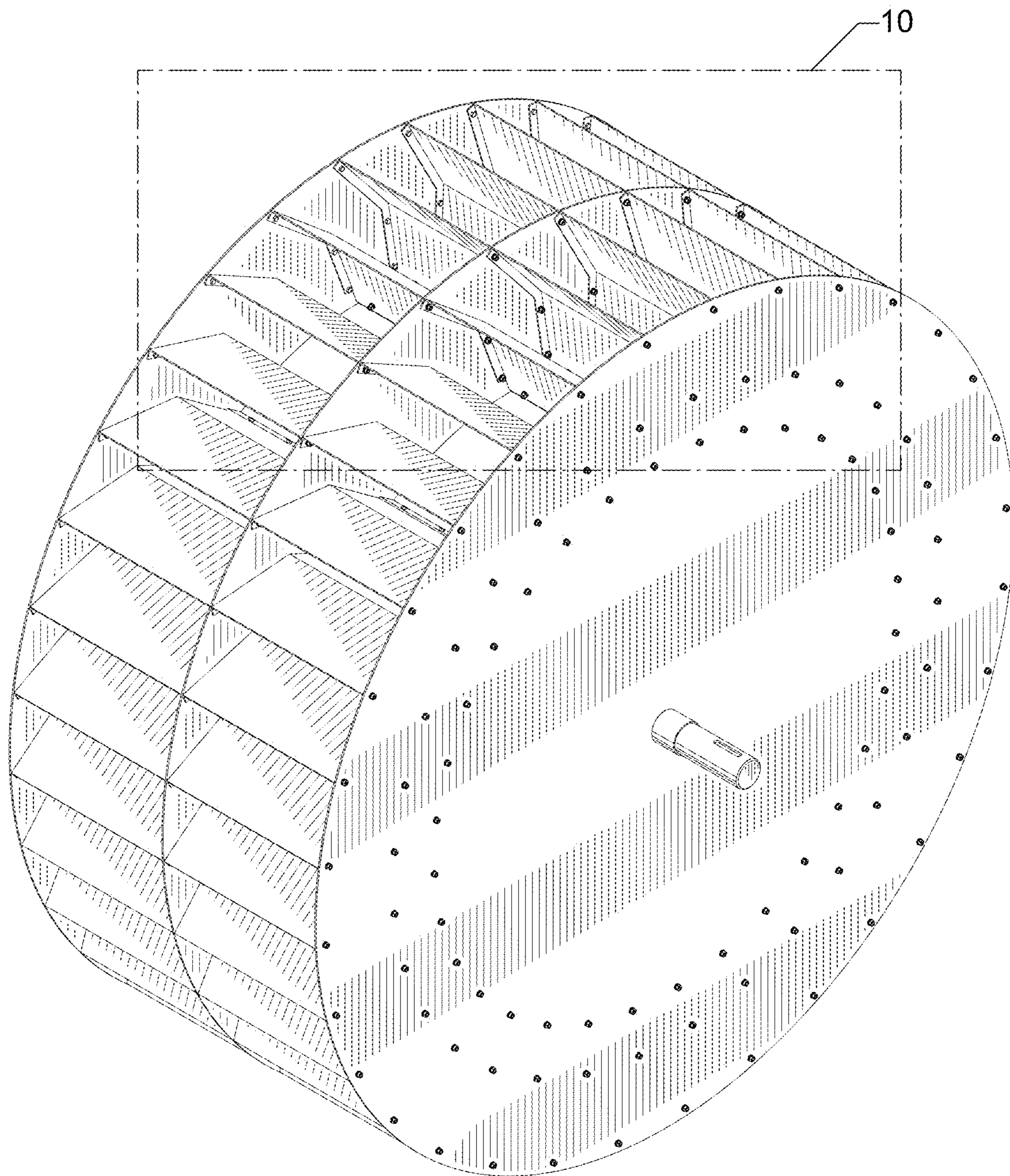

FIG. 9

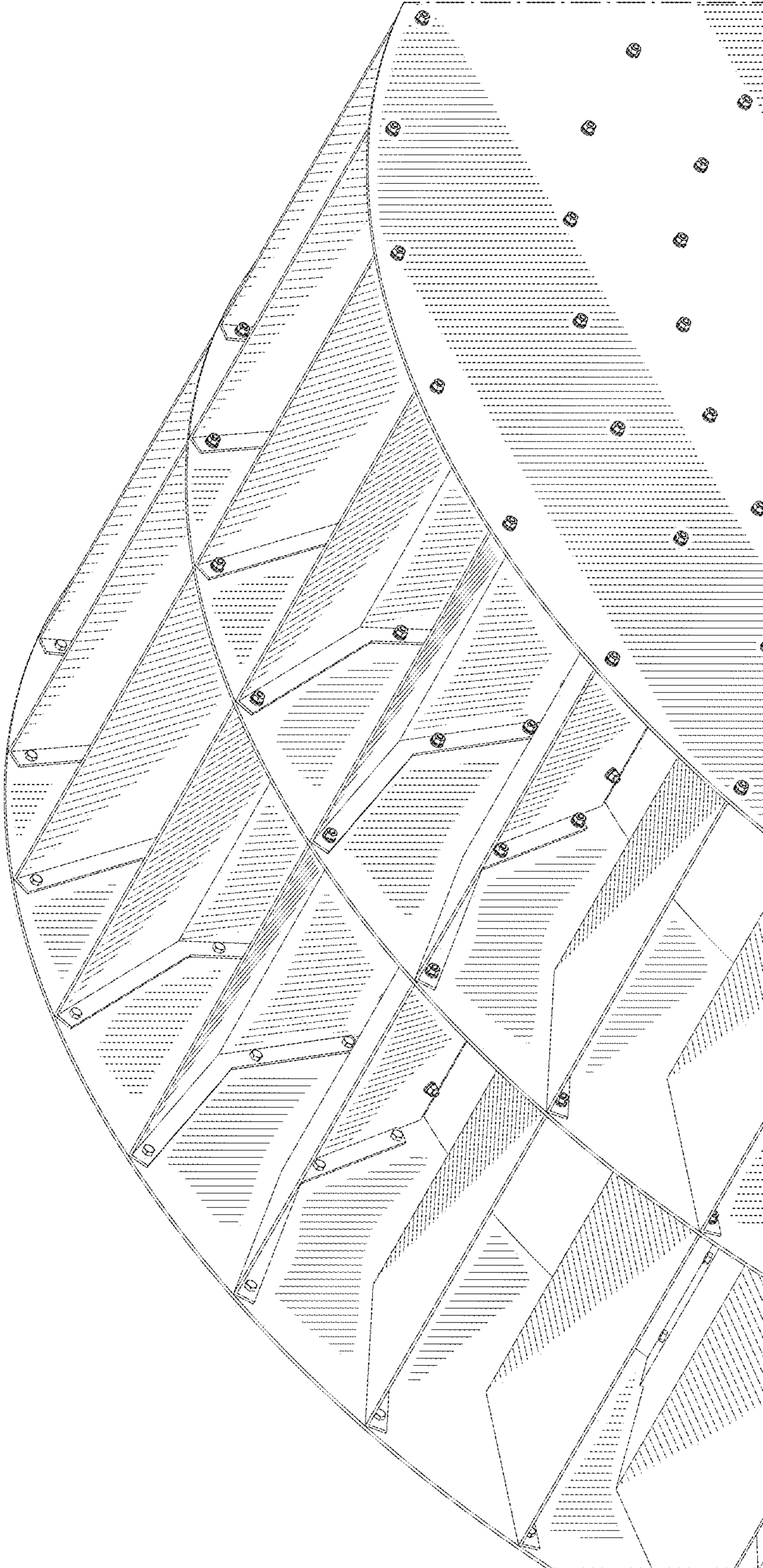

FIG. 10