



US00D884519S

(12) **United States Design Patent** (10) **Patent No.:** **US D884,519 S**
Armstrong et al. (45) **Date of Patent:** **** May 19, 2020**

- (54) **HANDHELD TESTER**
- (71) Applicant: **ARMSTRONG INTERNATIONAL, INC.**, Three Rivers, MI (US)
- (72) Inventors: **Kurt Armstrong**, Laguna Beach, CA (US); **James Edward Renwick**, Portland, OR (US); **Shane Russell**, Schoolcraft, MI (US)
- (73) Assignee: **ARMSTRONG INTERNATIONAL, INC.**, Three Rivers, MI (US)
- (**) Term: **15 Years**
- (21) Appl. No.: **29/664,293**
- (22) Filed: **Sep. 24, 2018**
- (51) **LOC (12) Cl.** **10-04**
- (52) **U.S. Cl.**
USPC **D10/78**
- (58) **Field of Classification Search**
USPC D10/46, 78
CPC F16T 1/48; F16T 1/00; Y10T 137/8158;
Y10T 137/3037; F17D 5/06
See application file for complete search history.

Primary Examiner — Antoine Duval Davis
(74) *Attorney, Agent, or Firm* — Dickinson Wright PLLC; Steven Hurles

(57) **CLAIM**

The ornamental design for a handheld tester, as shown and described.

DESCRIPTION

FIG. 1 is a perspective view of a handheld tester according to our design;
FIG. 2 is a top plan view of the handheld tester;
FIG. 3 is a bottom plan view of the handheld tester;
FIG. 4 is a left-side view of the handheld tester;
FIG. 5 is a right-side view of the handheld tester;
FIG. 6 is a front view of the handheld tester;
FIG. 7 is a rear view of the handheld tester; and,
FIG. 8 is a rear view of the handheld tester according to an alternate embodiment.
The broken lines in the figures show portions of the handheld tester that form no part of the claimed design.

- (56) **References Cited**
U.S. PATENT DOCUMENTS
4,898,022 A * 2/1990 Yumoto F16T 1/48
73/46

* cited by examiner

1 Claim, 8 Drawing Sheets

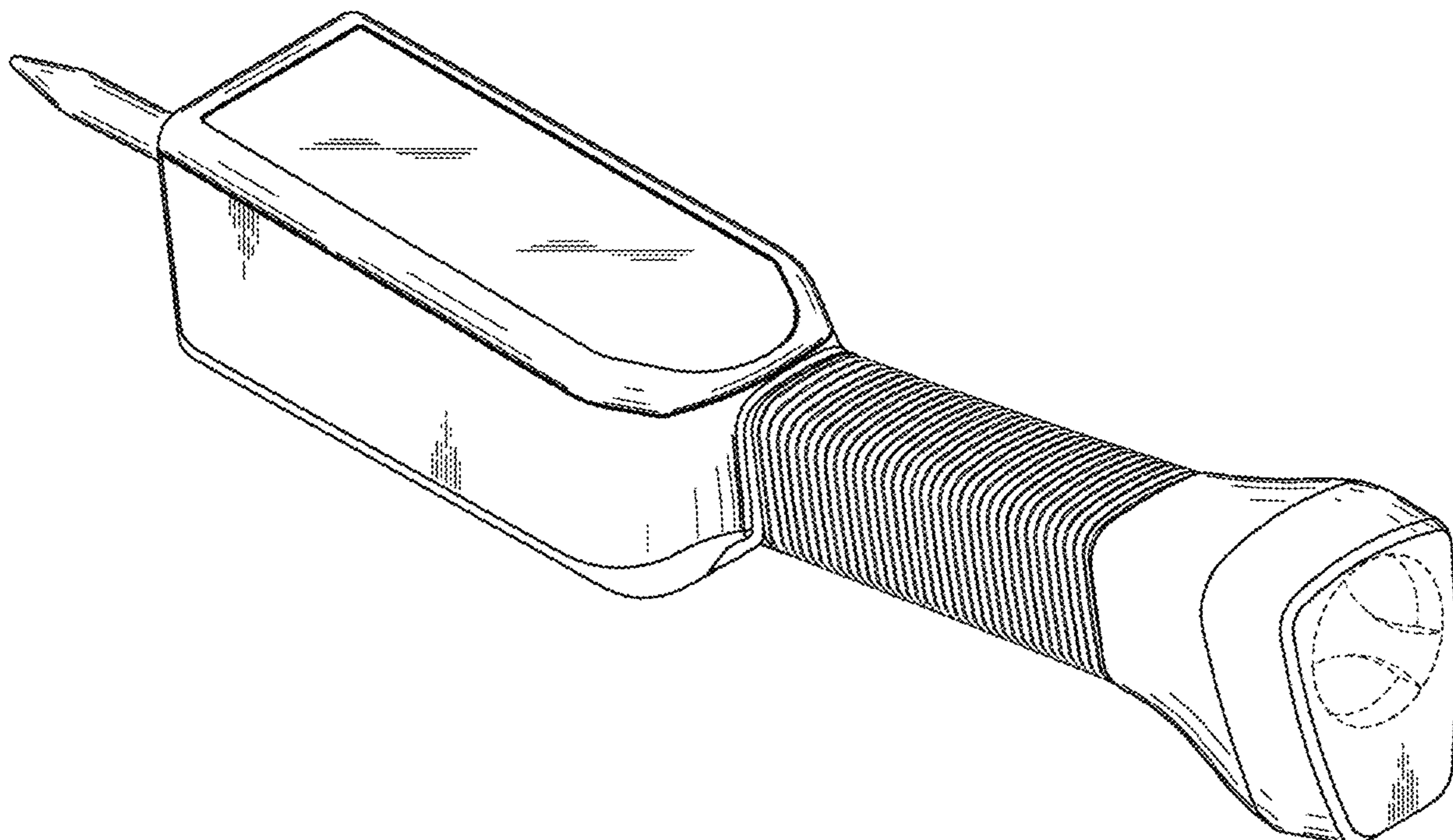

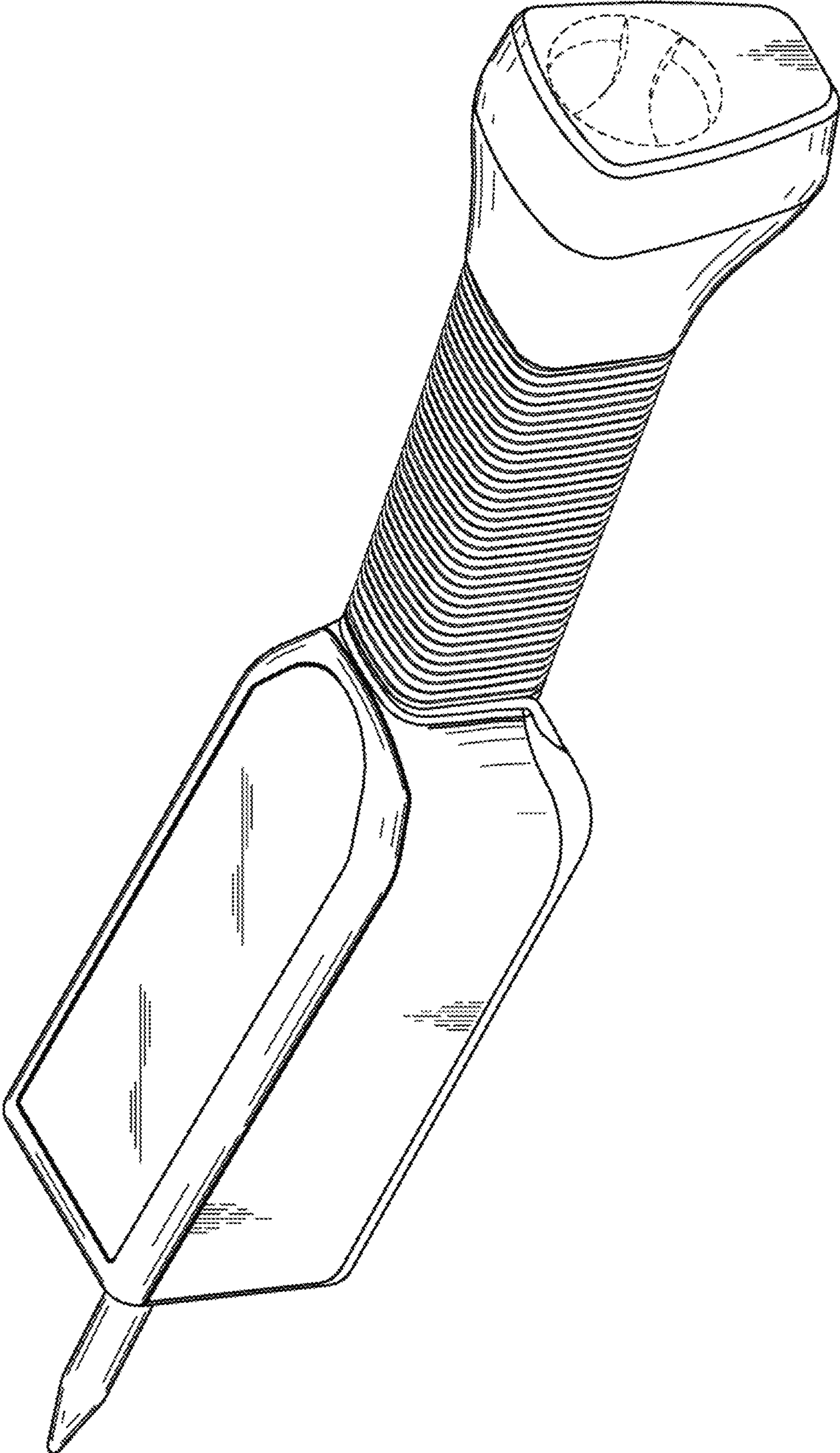

FIG. 1

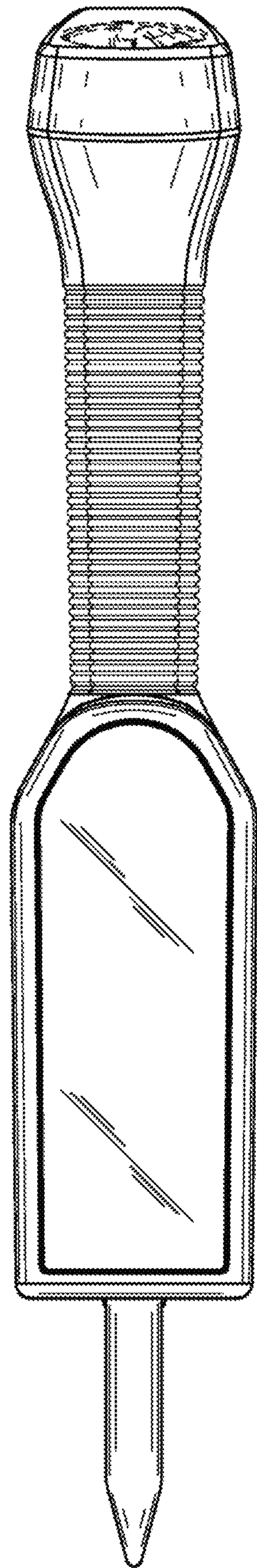

FIG. 2

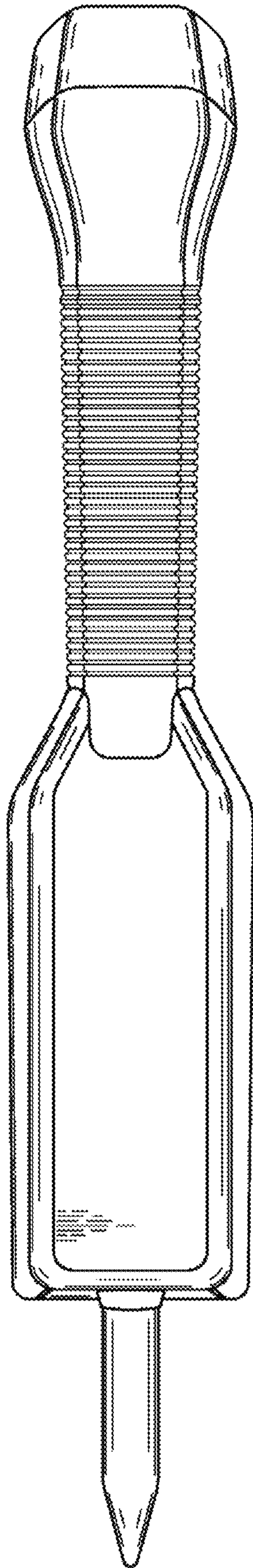

FIG. 3

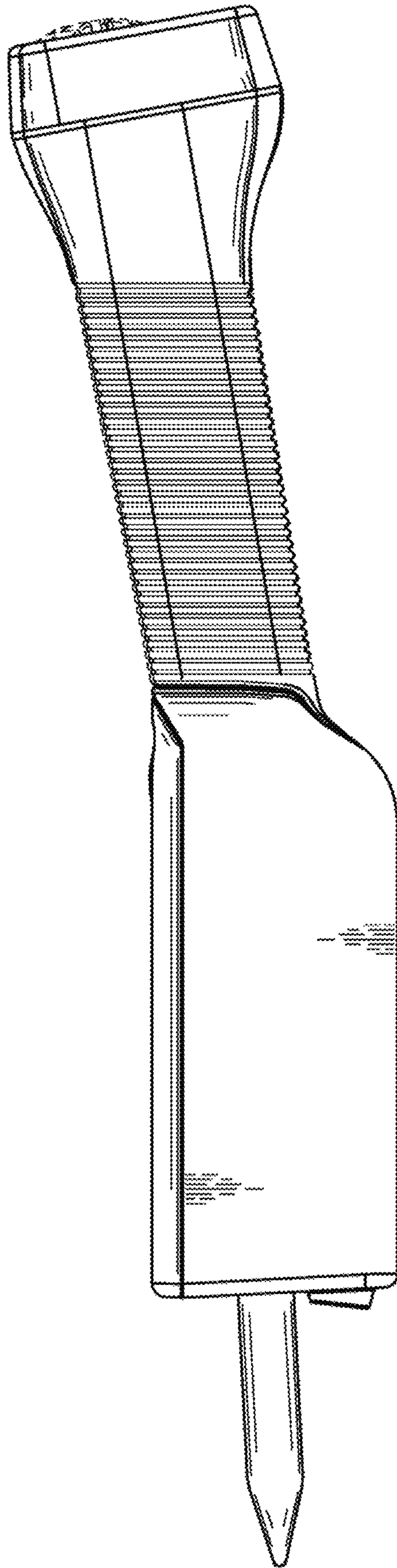

FIG. 4

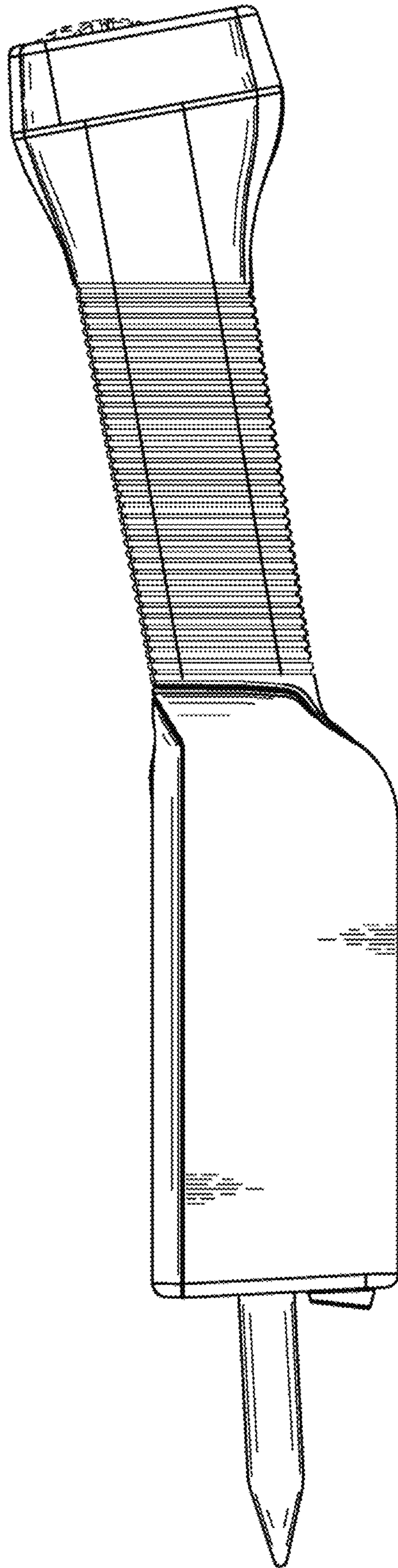

FIG. 5

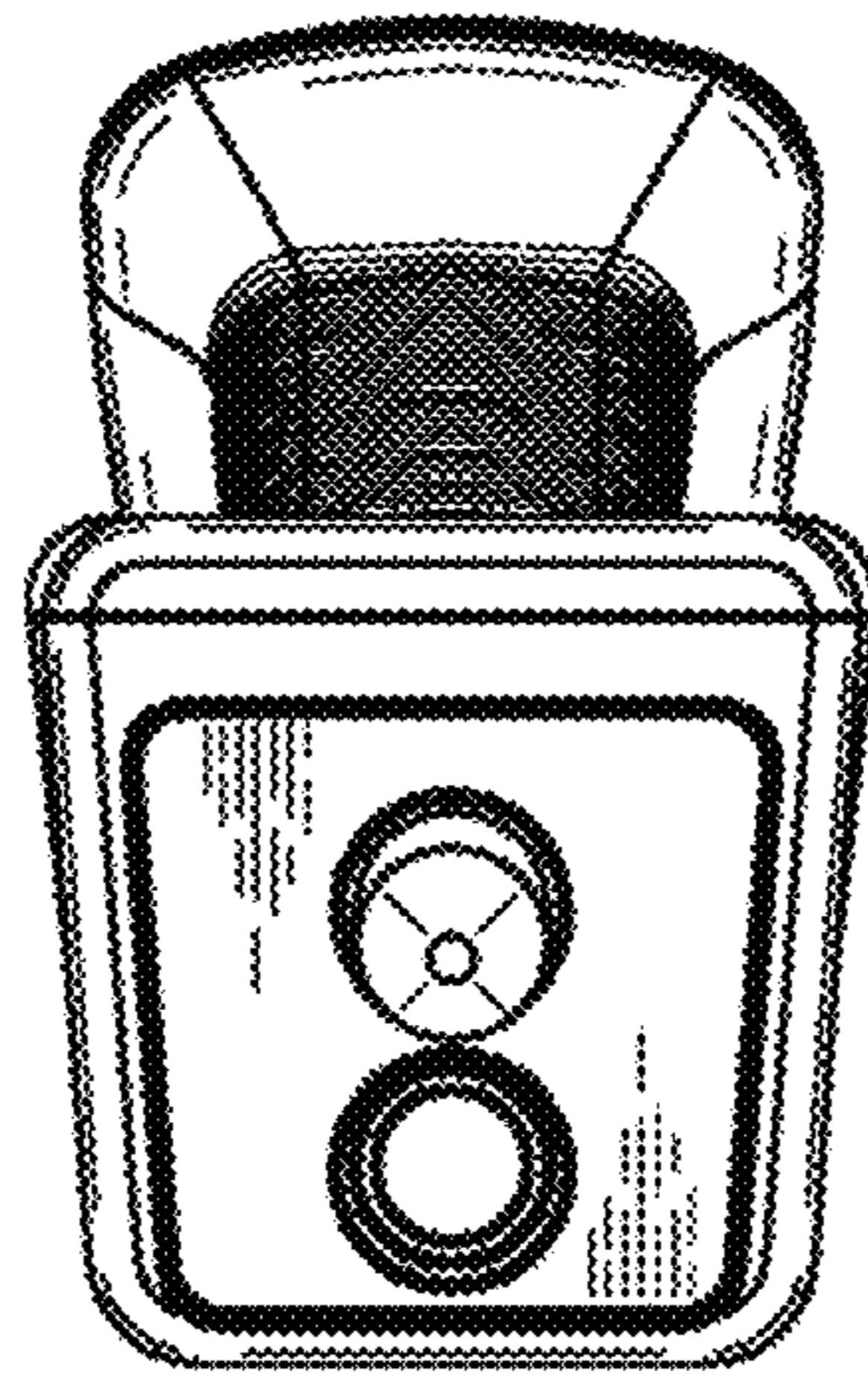

FIG. 6

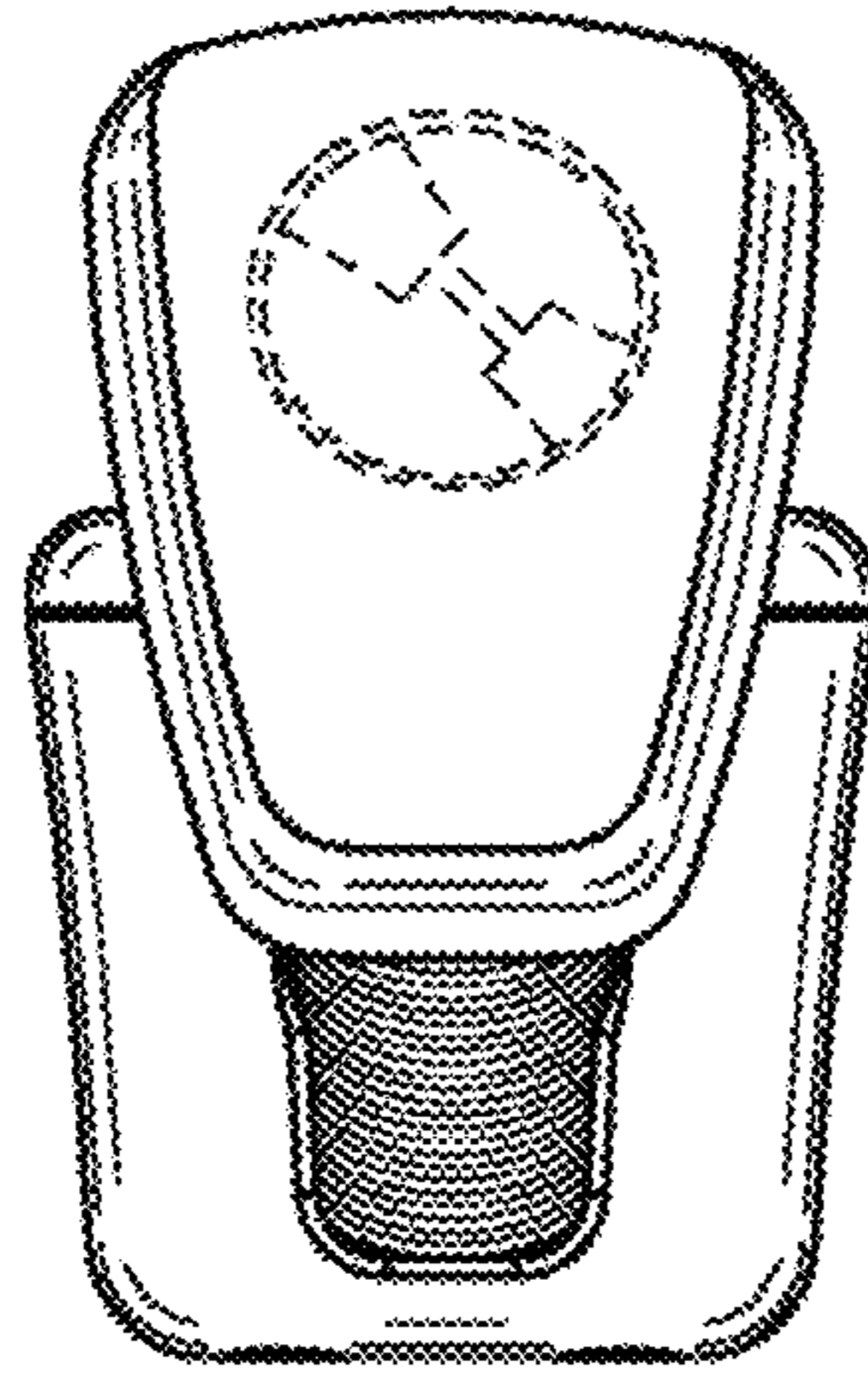

FIG. 7

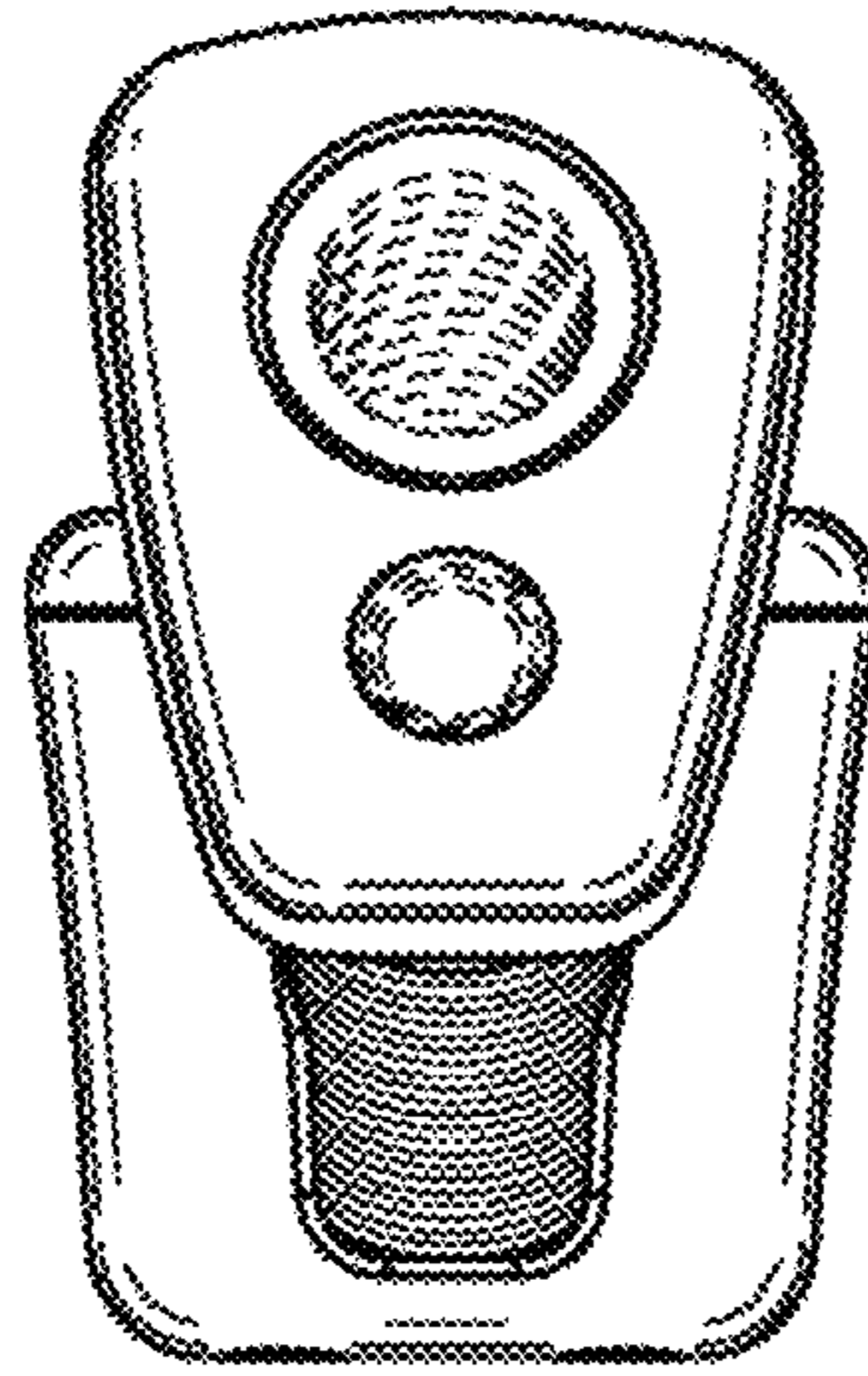

FIG. 8