



US00D884510S

(12) **United States Design Patent** (10) **Patent No.:** **US D884,510 S**  
**Yamazaki et al.** (45) **Date of Patent:** **\*\* May 19, 2020**

(54) **INFRARED DETECTOR**

**DESCRIPTION**

(71) Applicant: **HAMAMATSU PHOTONICS K.K.**,  
Hamamatsu-shi, Shizuoka (JP)  
(72) Inventors: **Masahiro Yamazaki**, Hamamatsu (JP);  
**Ryusuke Kitaura**, Hamamatsu (JP);  
**Katsumi Shibayama**, Hamamatsu (JP)  
(73) Assignee: **HAMAMATSU PHOTONICS K.K.**,  
Hamamatsu-shi, Shizuoka (JP)  
(\*\*) Term: **15 Years**  
(21) Appl. No.: **29/672,830**  
(22) Filed: **Dec. 10, 2018**  
(30) **Foreign Application Priority Data**  
Jun. 13, 2018 (JP) ..... 2018-012968  
(51) **LOC (12) Cl.** ..... **10-04**  
(52) **U.S. Cl.**  
USPC ..... **D10/70**  
(58) **Field of Classification Search**  
USPC ..... D10/46, 70, 102  
(Continued)  
(56) **References Cited**  
U.S. PATENT DOCUMENTS  
8,436,306 B2 \* 5/2013 Tai ..... H01L 37/02  
250/338.3  
8,598,528 B2 \* 12/2013 Boutami ..... G01J 5/20  
250/338.1  
(Continued)

FIG. 1 is a perspective view of a first embodiment of an infrared detector showing our new design;  
FIG. 2 is a front view thereof;  
FIG. 3 is a rear view thereof;  
FIG. 4 is a top plan view thereof;  
FIG. 5 is a bottom view thereof;  
FIG. 6 is a right side view thereof;  
FIG. 7 is a left side view thereof;  
FIG. 8 is an enlarged sectional view taken along the line 8-8 in FIG. 4 defined by the lines 801-801;  
FIG. 9 is an enlarged sectional view taken along the line 9-9 in FIG. 4 defined by the lines 901-901, 902-902 and 903-903;  
FIG. 10 is an enlarged sectional view taken along the line 10-10 in FIG. 4 defined by the lines 1001-1001;  
FIG. 11 is an enlarged sectional view taken along the line 11-11 in FIG. 4 defined by the lines 1101-1101;  
FIG. 12 is a perspective view of a second embodiment of an infrared detector showing our new design;  
FIG. 13 is a front view thereof;  
FIG. 14 is a rear view thereof;  
FIG. 15 is a top plan view thereof;  
FIG. 16 is a bottom view thereof;  
FIG. 17 is a right side view thereof;  
FIG. 18 is a left side view thereof;  
FIG. 19 is an enlarged sectional view taken along the line 19-19 in FIG. 15 defined by the lines 1901-1901;  
FIG. 20 is an enlarged sectional view taken along the line 20-20 in FIG. 15 defined by the lines 2001-2001, 2002-2002 and 2003-2003;  
FIG. 21 is an enlarged sectional view taken along the line 21-21 in FIG. 15 defined by the lines 2101-2101; and,  
FIG. 22 is an enlarged sectional view taken along the line 22-22 in FIG. 15 defined by the lines 2201-2201.  
The features shown in broken lines depict environmental subject matter only and form no part of the claimed design. The alternate long and short dash lines are merely the boundary lines between the claimed parts and the non-claimed parts.

*Primary Examiner* — Antoine Duval Davis  
(74) *Attorney, Agent, or Firm* — Faegre Drinker Biddle & Reath LLP

(57) **CLAIM**  
The ornamental design for an infrared detector, as shown and described.

**1 Claim, 22 Drawing Sheets**

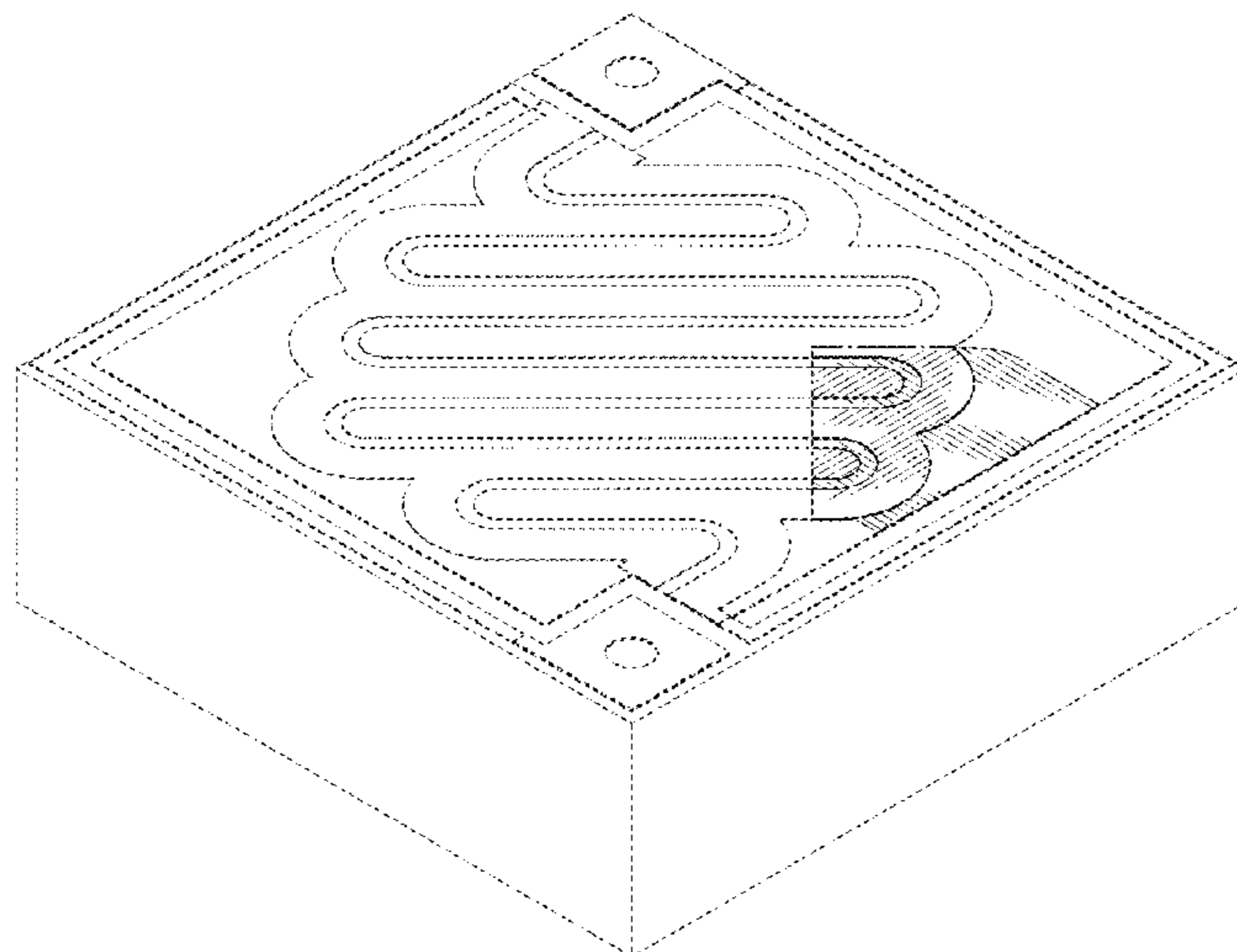

(58) **Field of Classification Search**

CPC .. G02B 26/001; G01T 1/20; G01J 5/10; G01J 5/12; G01J 5/15; G01J 5/0853; G01J 5/0846; G01J 1/42; G01J 3/36; G01J 2005/0077; G01N 21/53; G01N 21/65; G01N 21/658; H01L 27/14; H01L 27/1146; H01L 27/142; H01L 31/02325; H01L 31/102; H01L 31/02327; H01L 31/1013; H01L 31/00; H01L 31/04; H01L 31/09; H01J 27/14683; H01J 27/14649; H04N 5/32; H04N 5/23241; H04N 5/33; B27C 5/10; B27C 5/02; Y10T 409/306608; G01V 8/20; G08B 13/1645; G08B 13/16; G08B 13/1609; G08B 13/1627; G08B 13/1618; G08B 13/1636; G08B 13/1654; G08B 13/1663; G08B 13/1672; G08B 13/1681; G08B 13/16169; G08B 13/181; G08B 13/183; G08B 13/184; G08B 13/186; G08B 13/187;

G08B 13/189; G08B 13/1895; G08B 13/19; G08B 13/191; G08B 13/193; G08B 17/12; H03K 17/941; H03K 2017/9455; H03K 17/9505; H03K 17/9622; H03K 17/9627; H05B 37/0227

See application file for complete search history.

(56)

**References Cited**

U.S. PATENT DOCUMENTS

8,941,203 B2 \* 1/2015 Wehner ..... H01L 27/1446  
257/233  
9,976,910 B2 \* 5/2018 Yagami ..... G01J 5/0846  
D825,358 S \* 8/2018 Lee ..... H01L 27/1446  
D10/70  
D825,359 S \* 8/2018 Lee ..... G01J 5/0846  
D10/70  
10,175,107 B2 \* 1/2019 Shibayama ..... G01J 3/26

\* cited by examiner

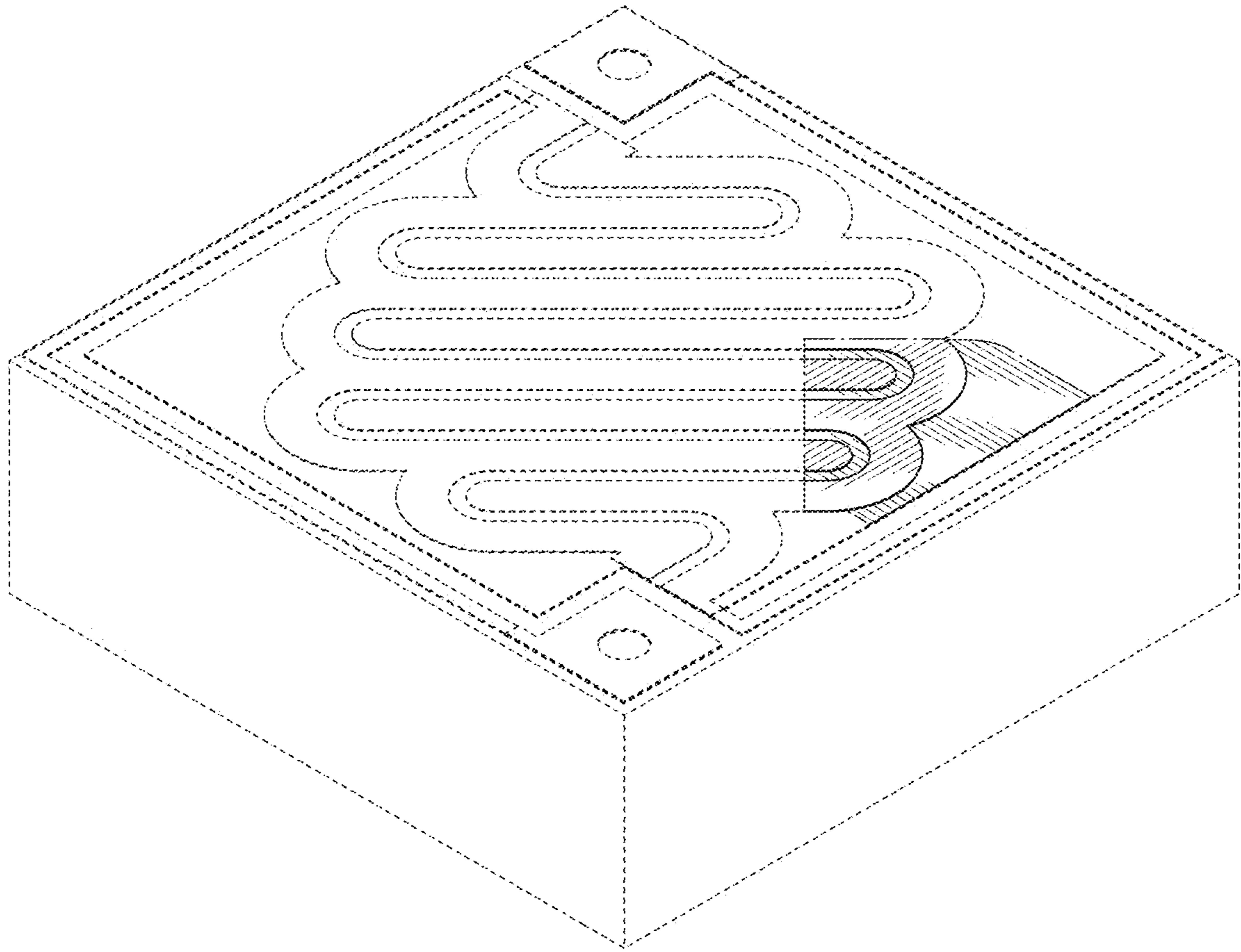

FIG. 1

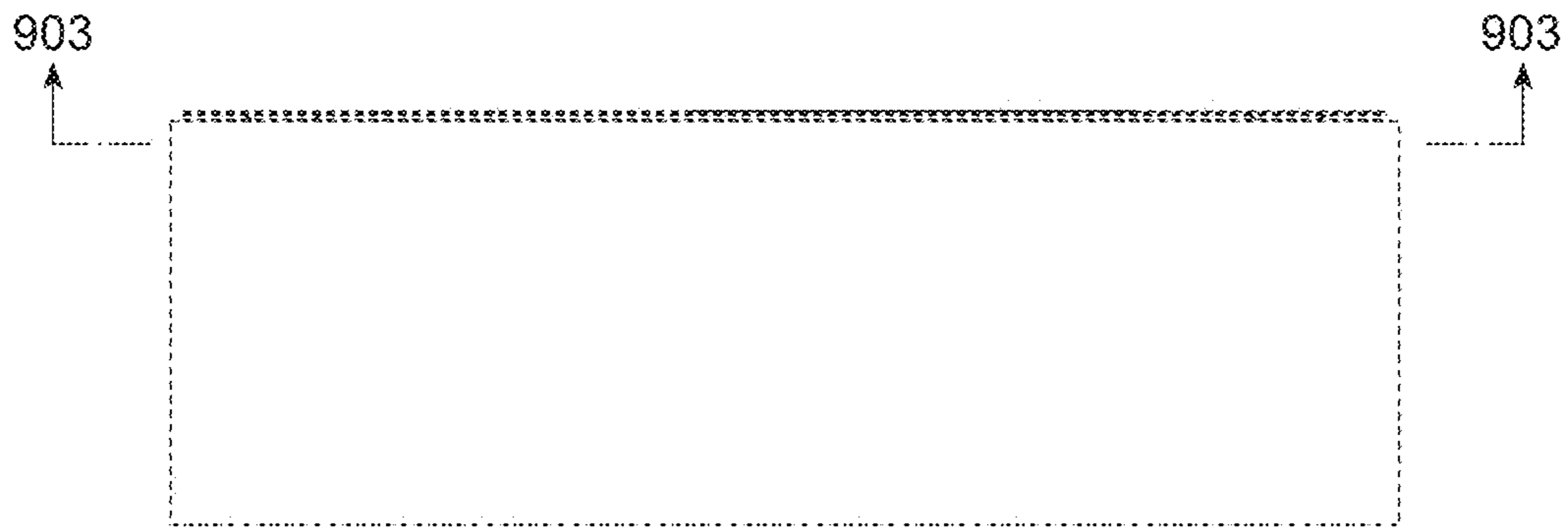
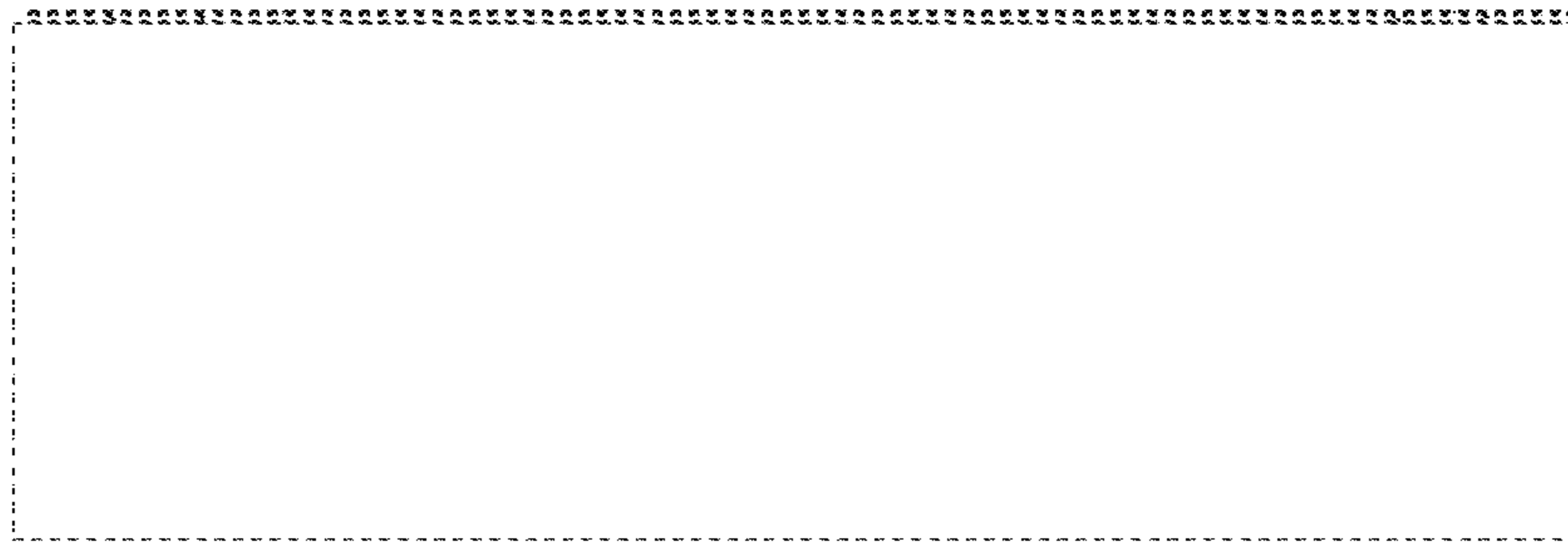

FIG. 2



**FIG. 3**

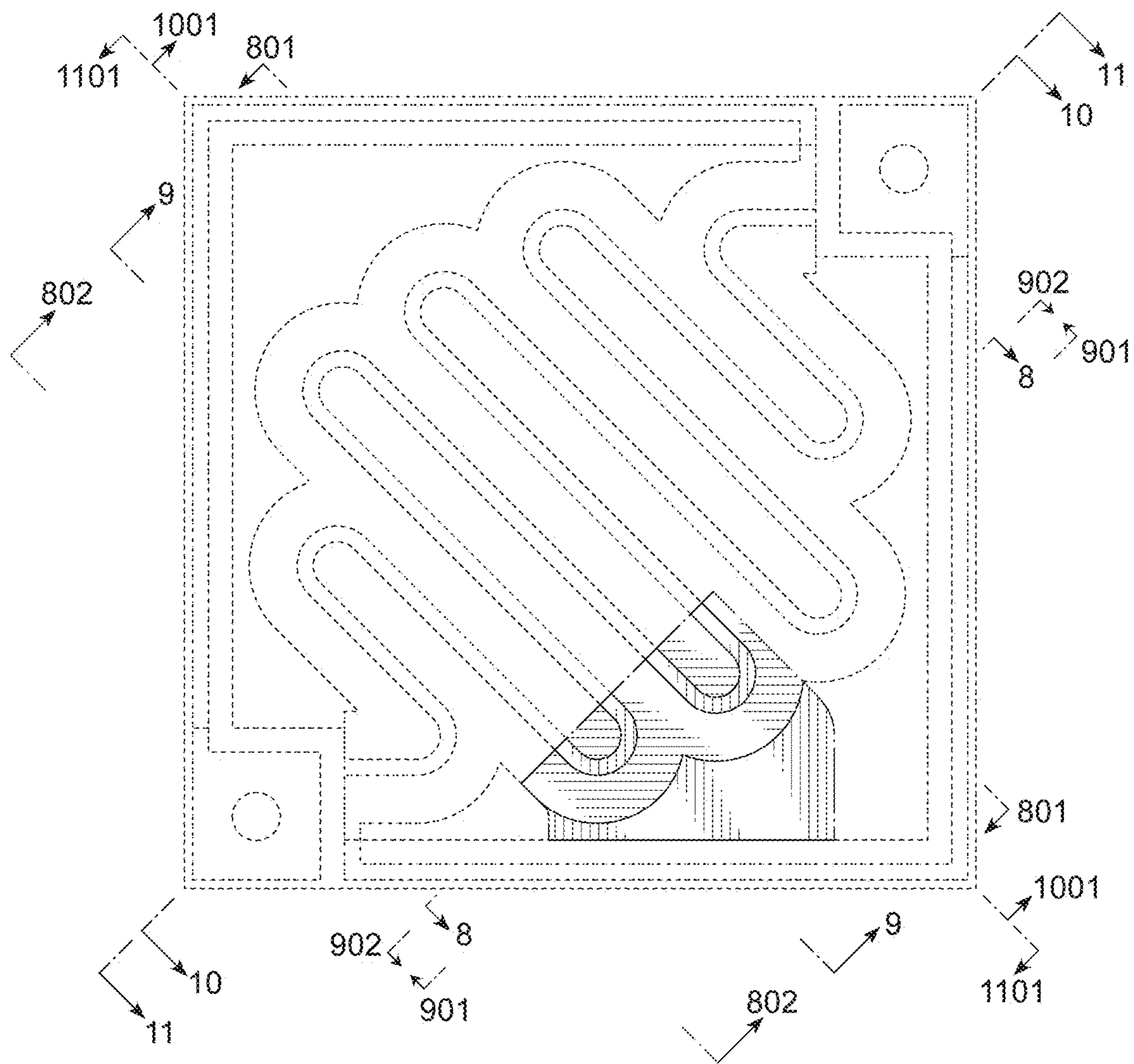

FIG. 4

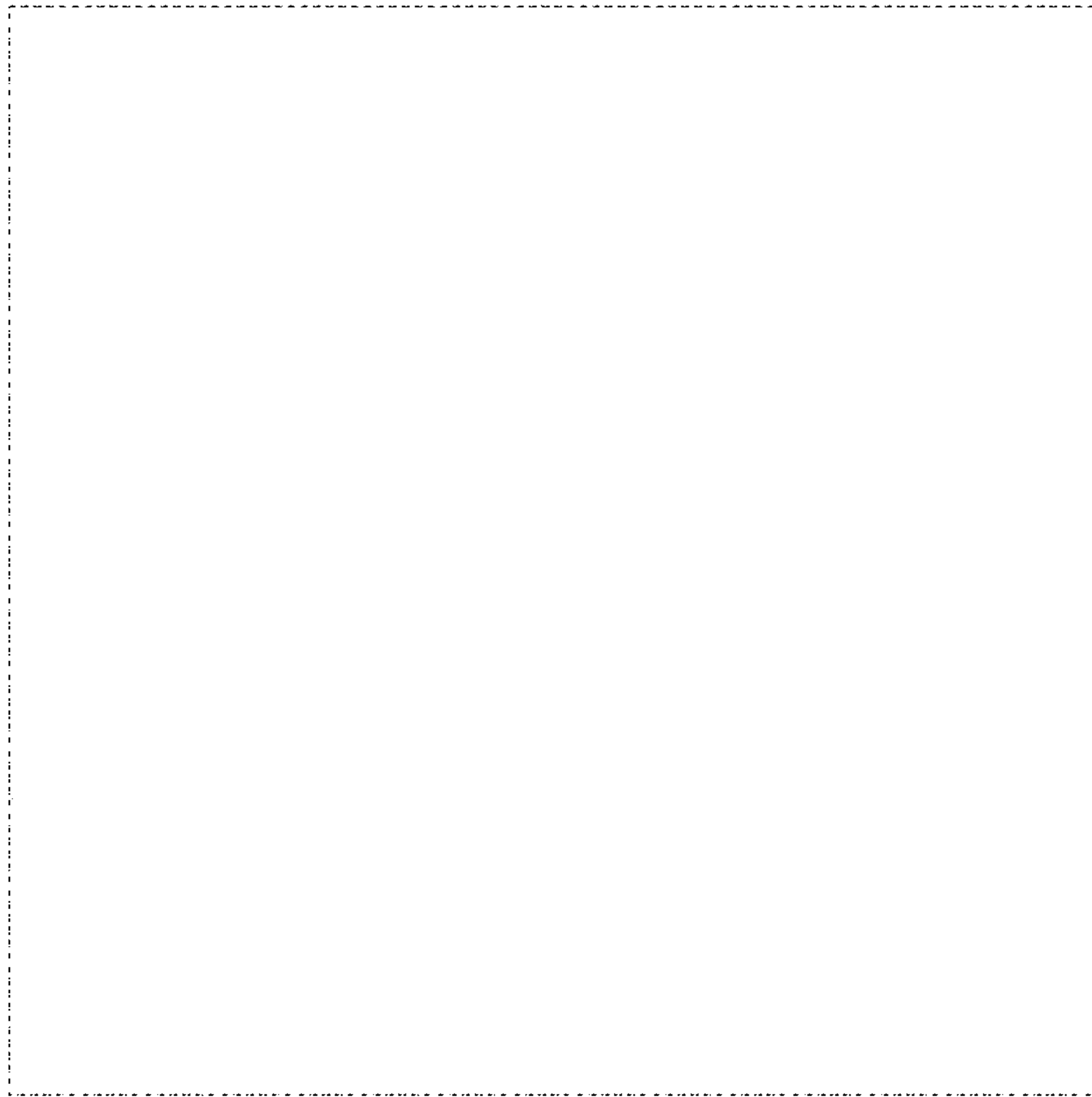
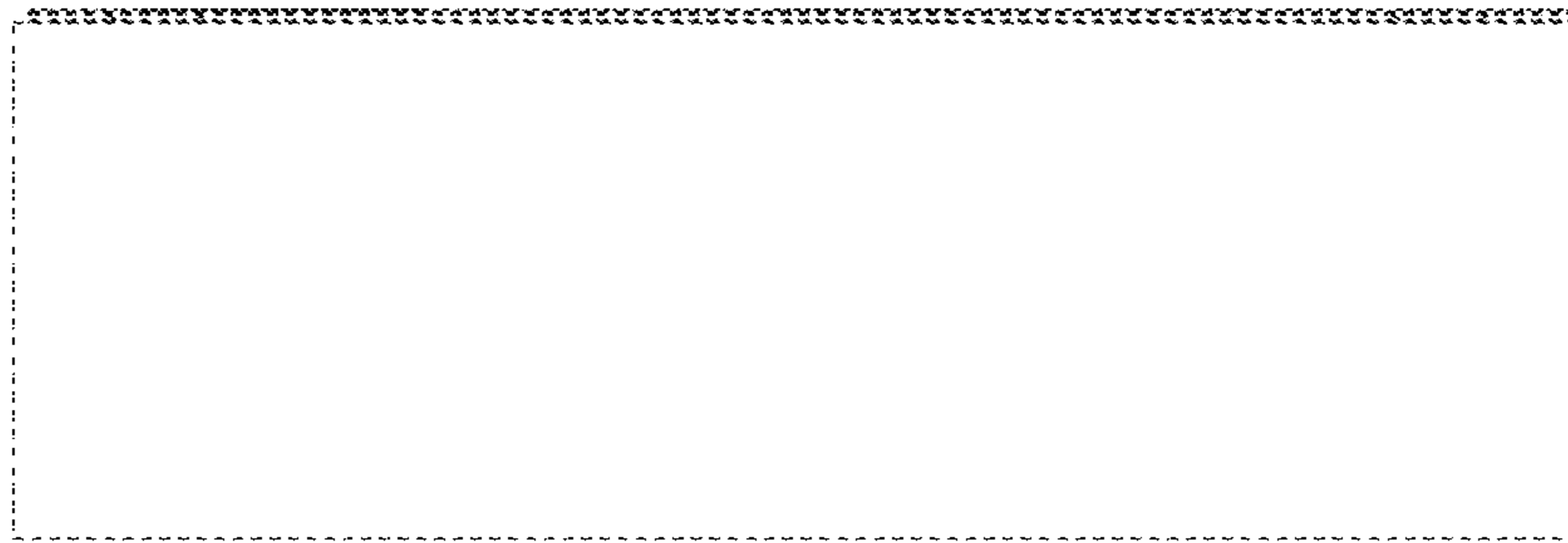
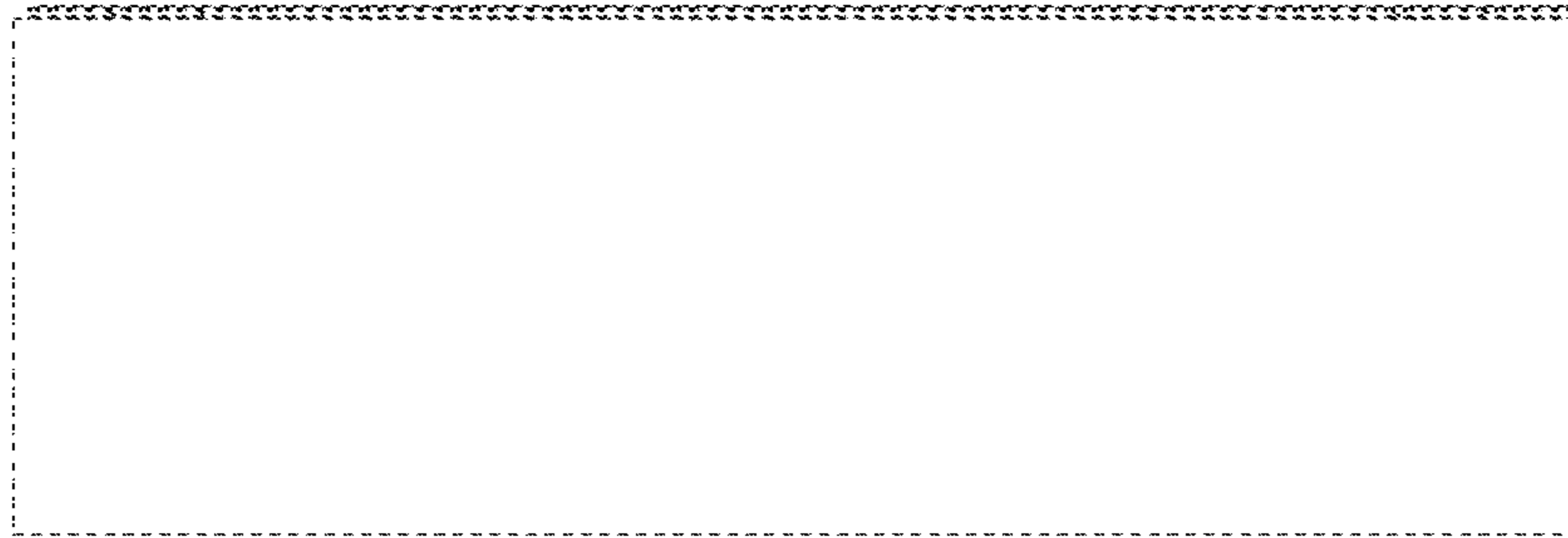

FIG. 5



**FIG. 6**





**FIG. 7**

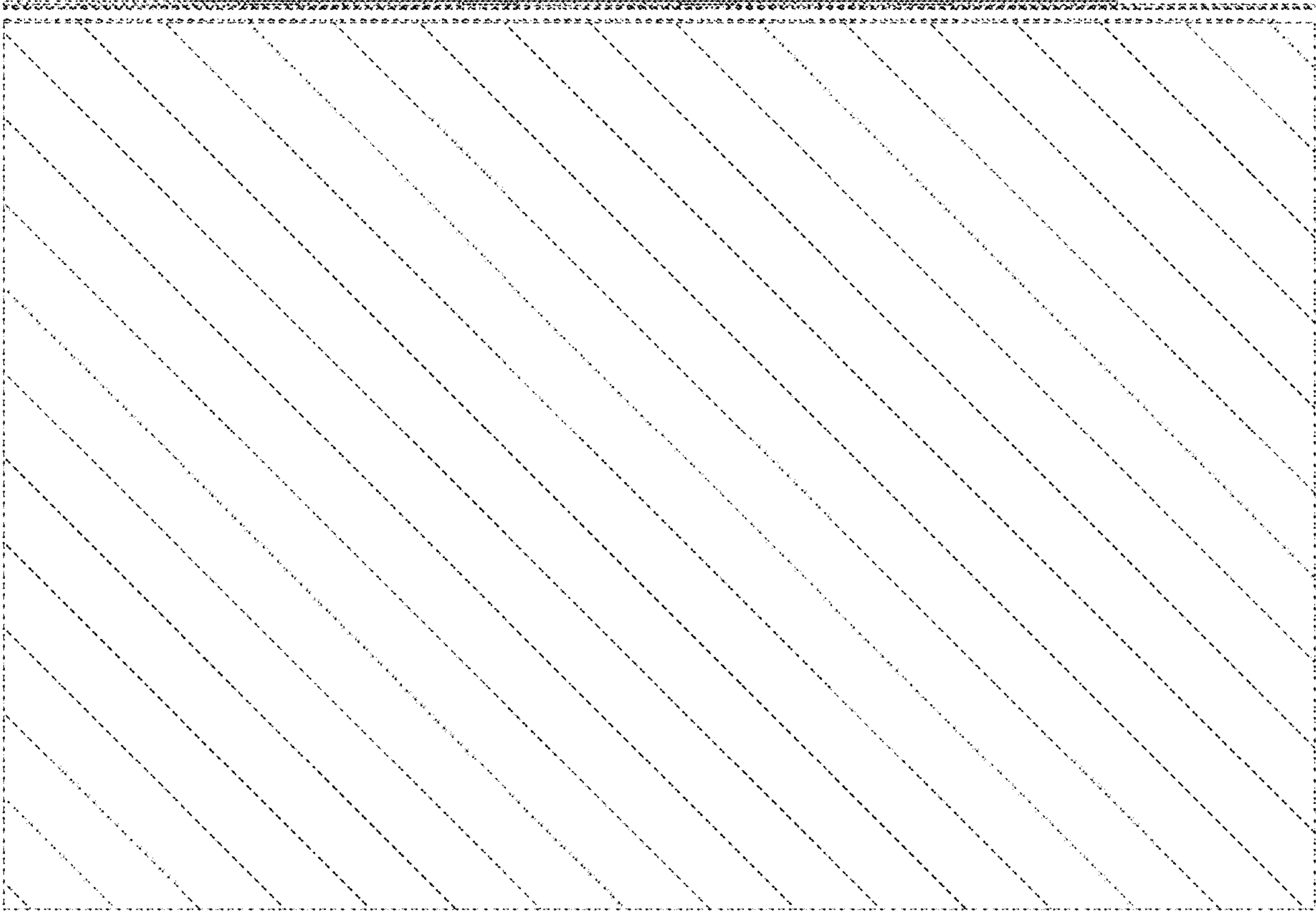

FIG. 8

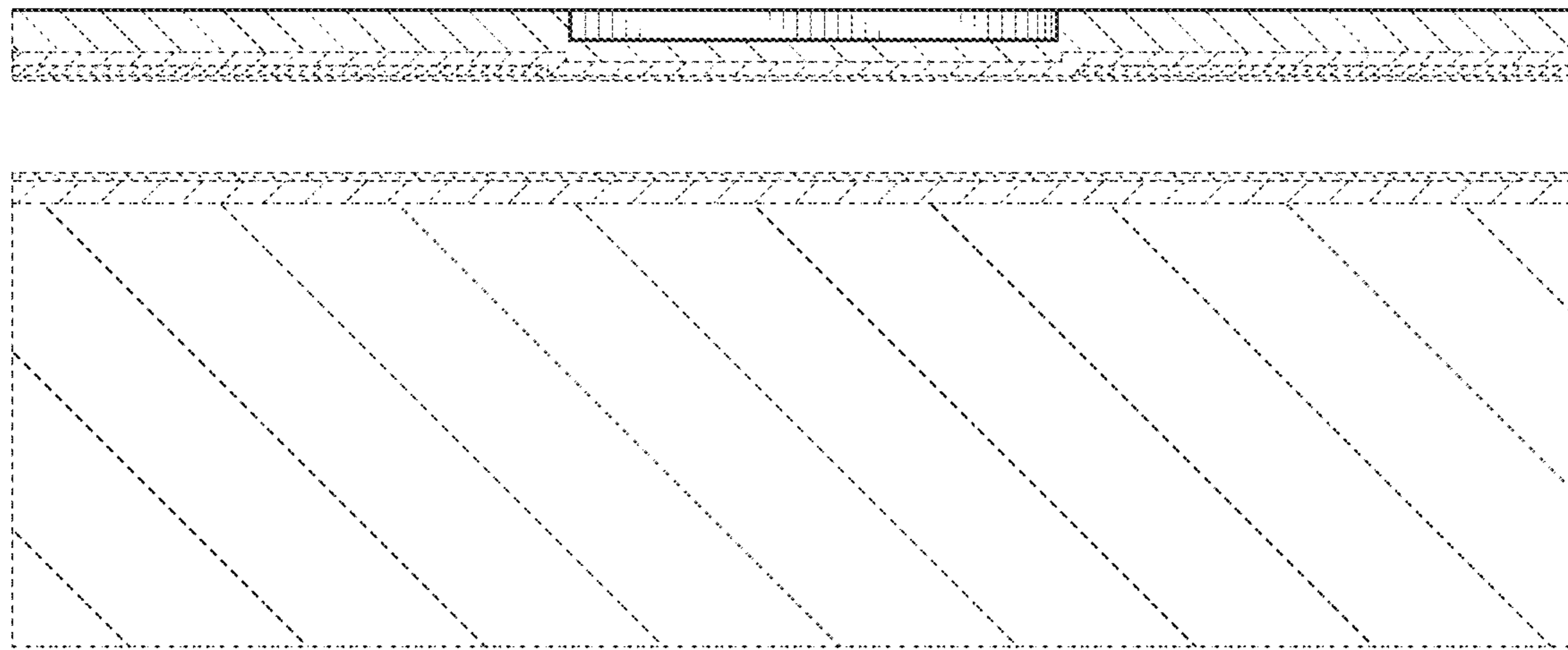

FIG. 9

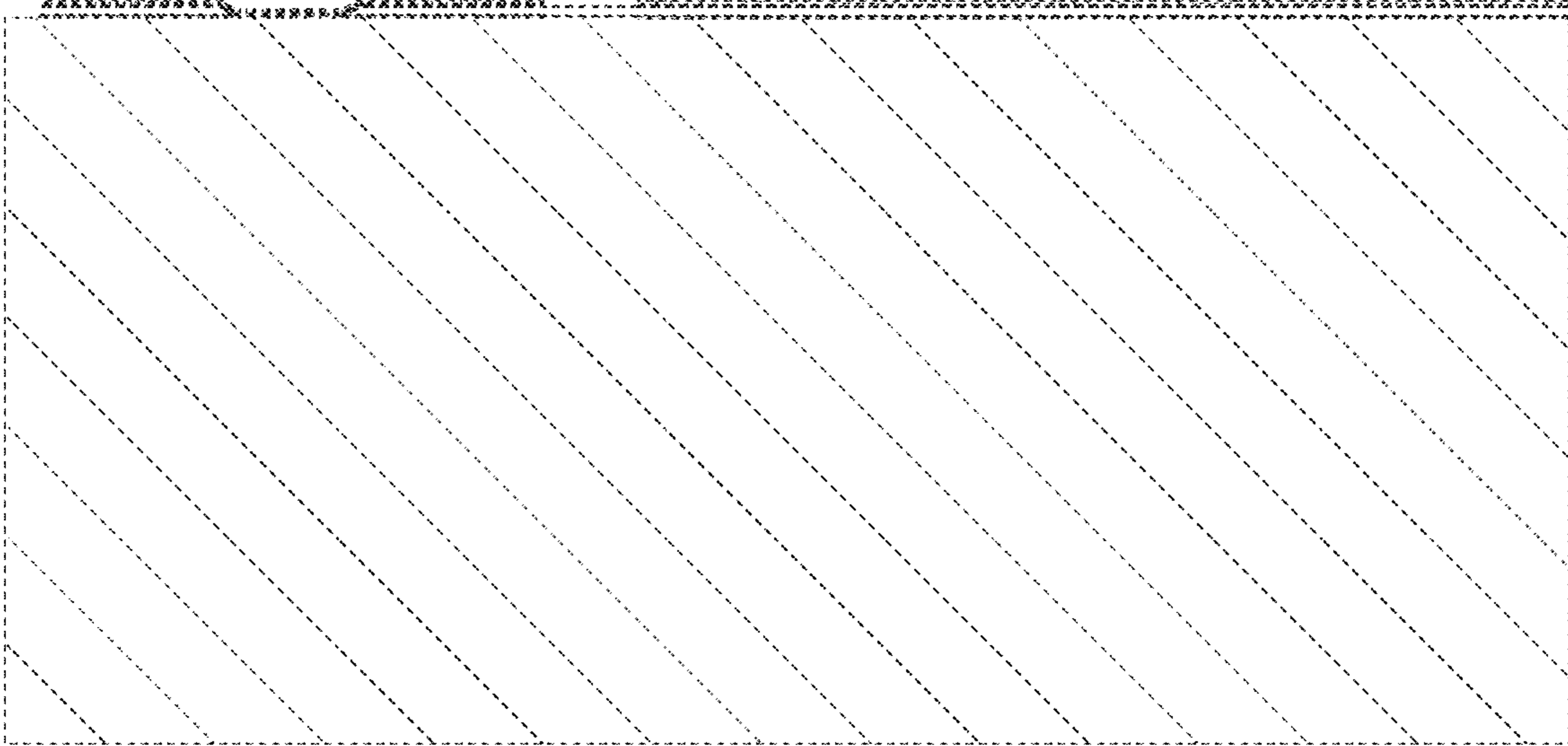

FIG. 10

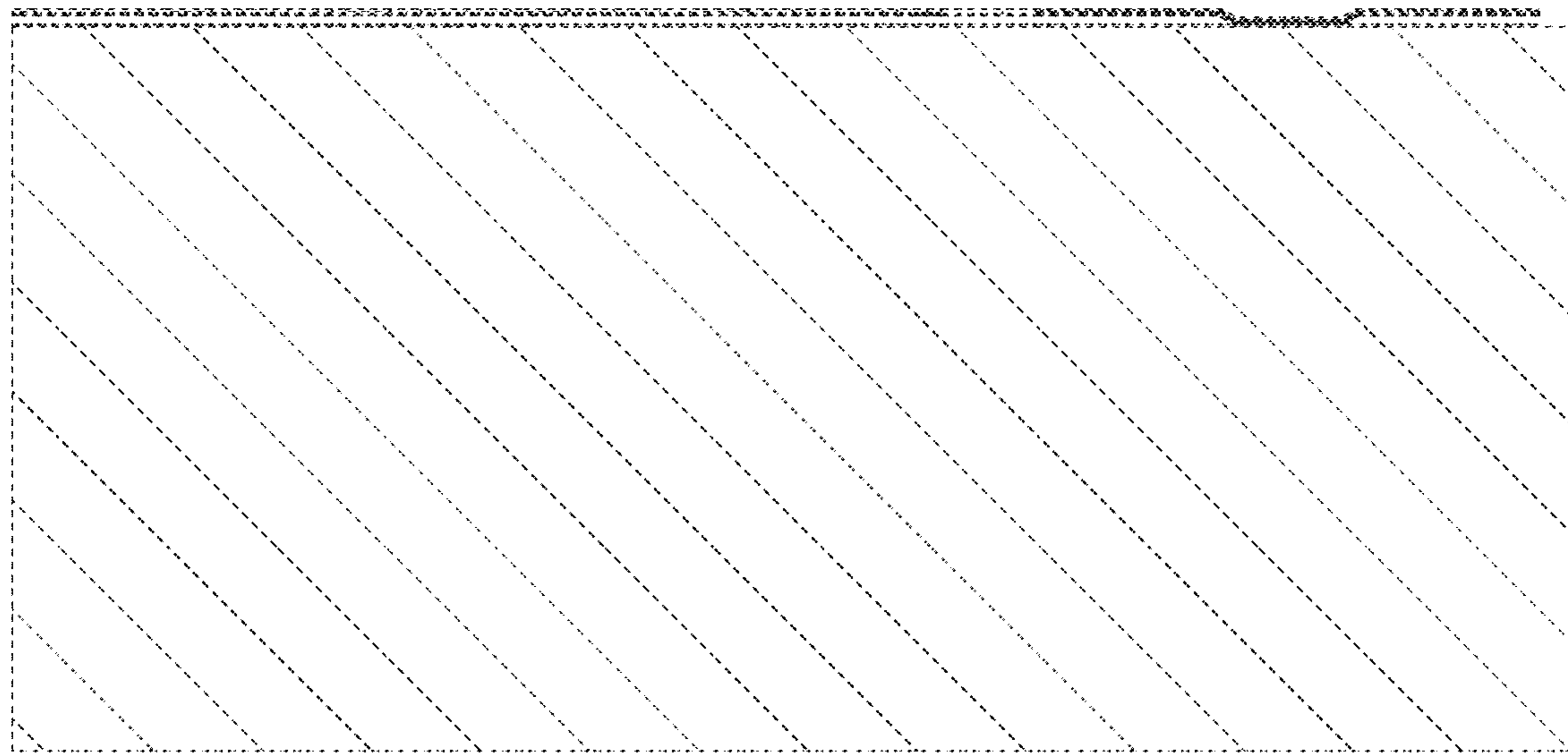

FIG. 11

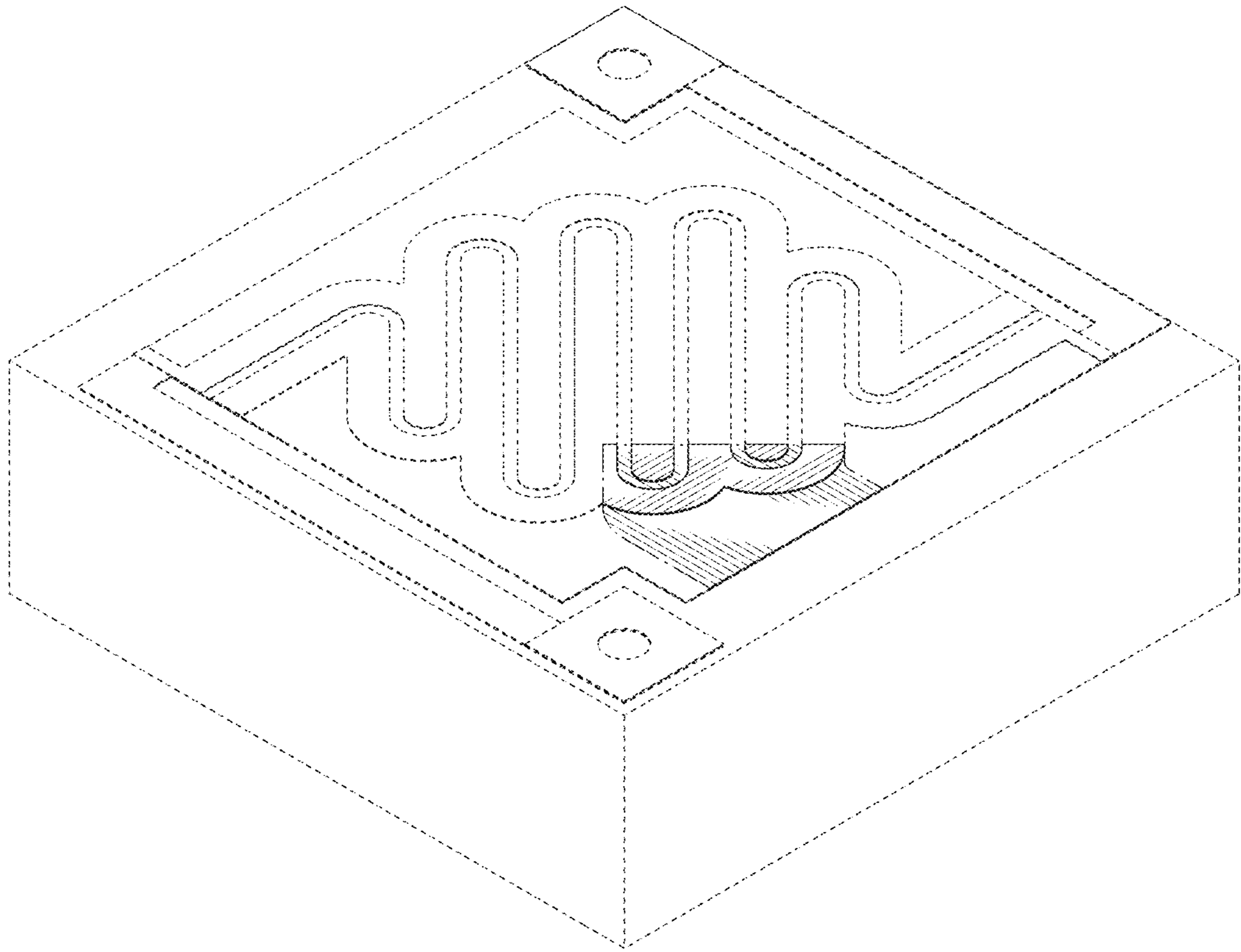

FIG. 12

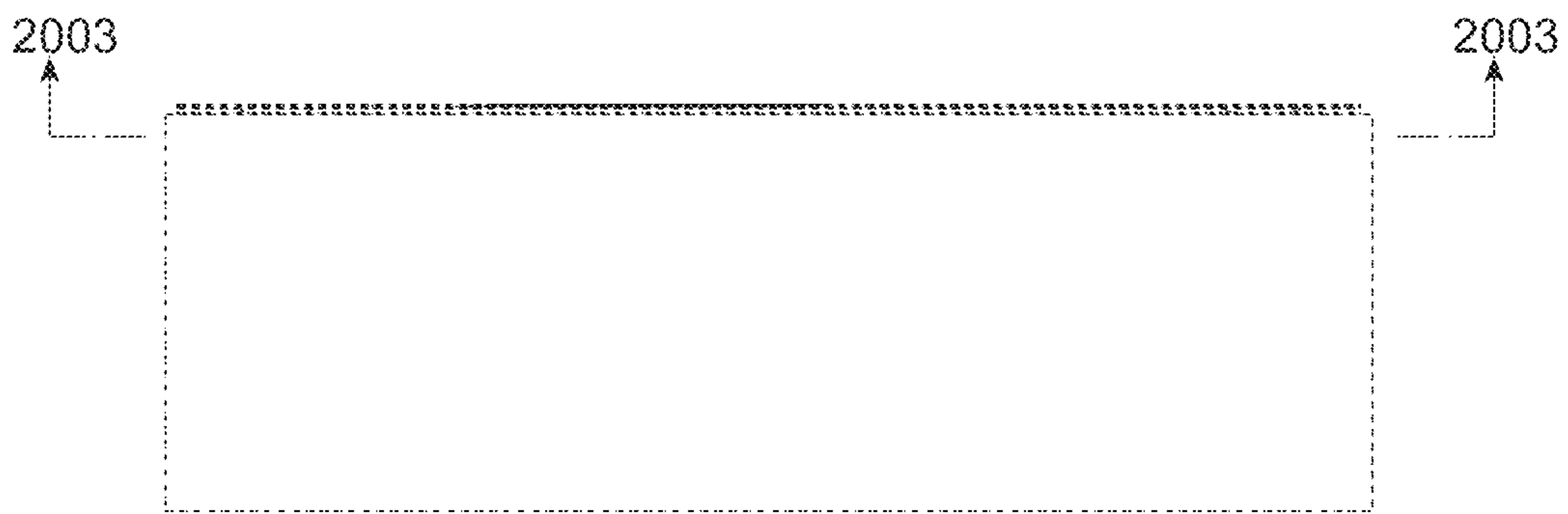

FIG. 13

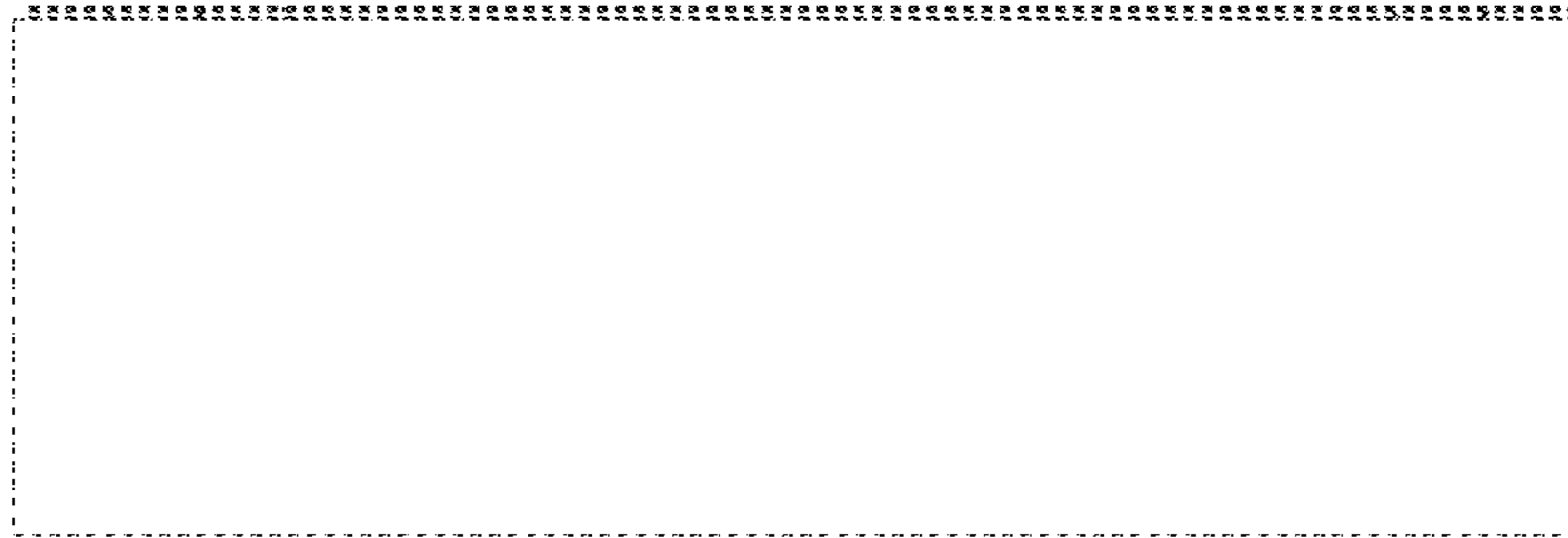

FIG. 14



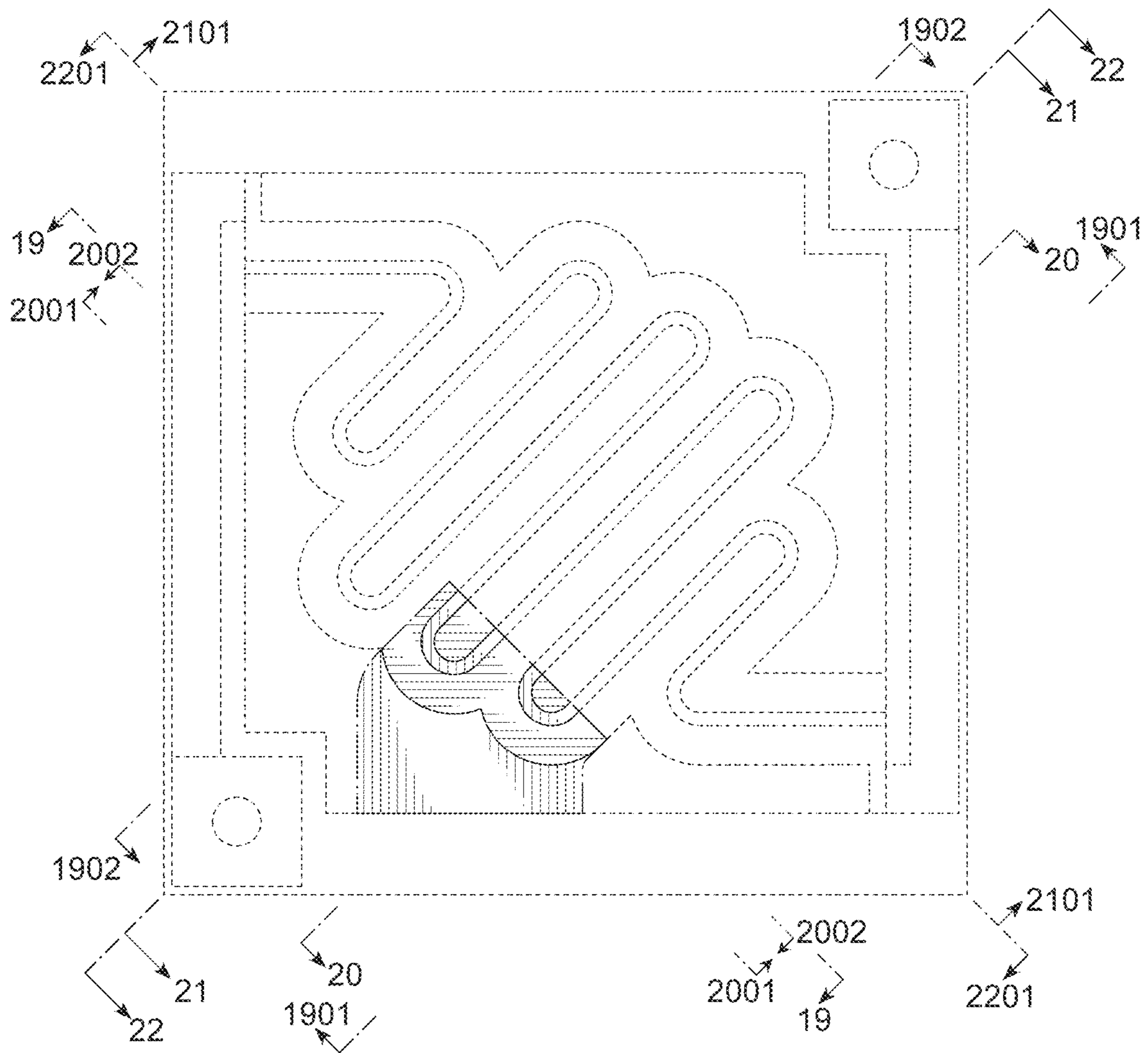

FIG. 15



**FIG. 16**

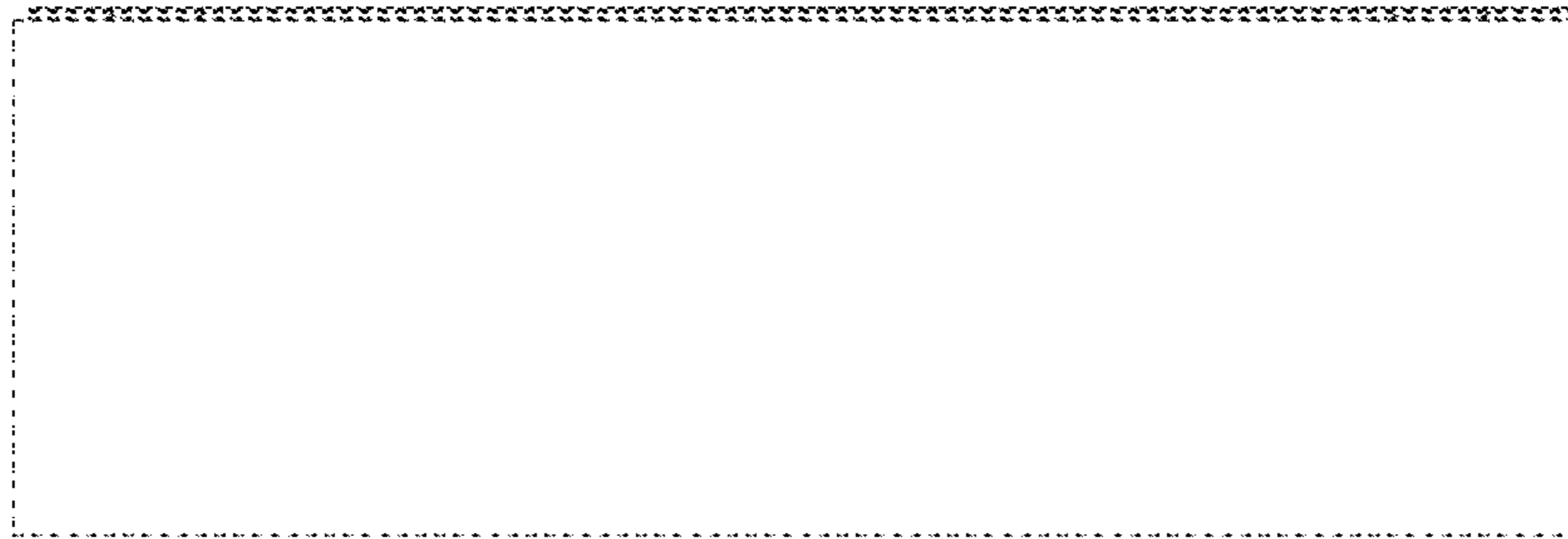

FIG. 17

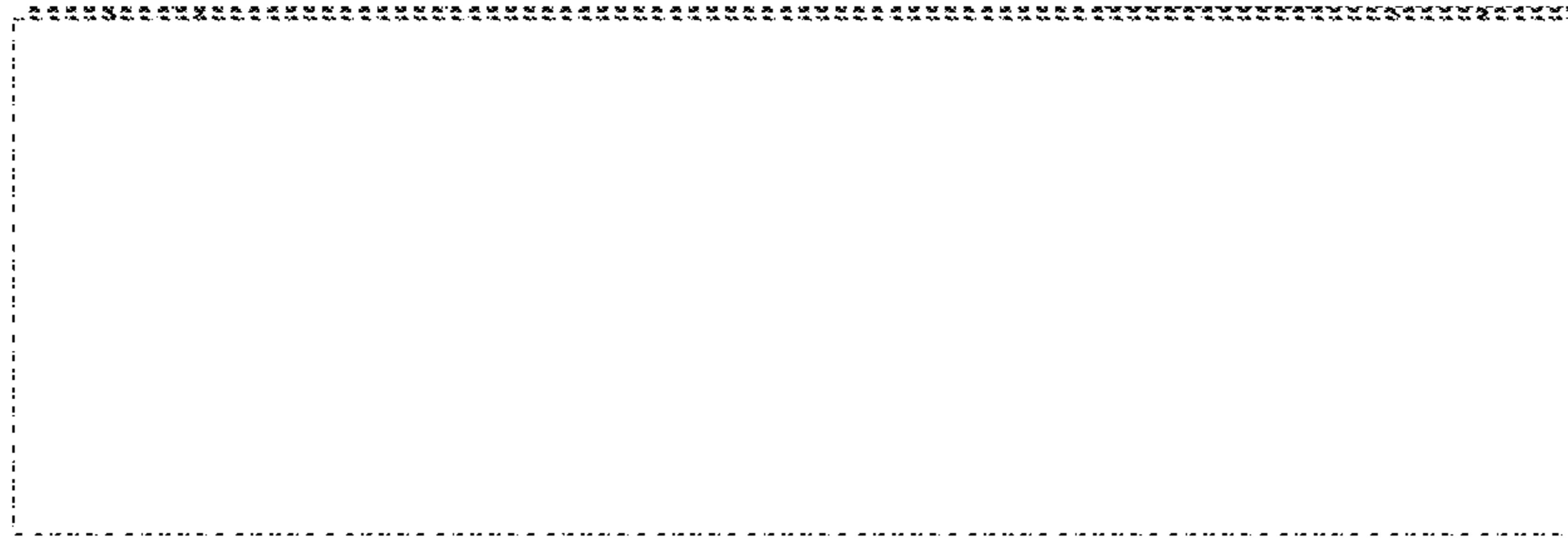

FIG. 18

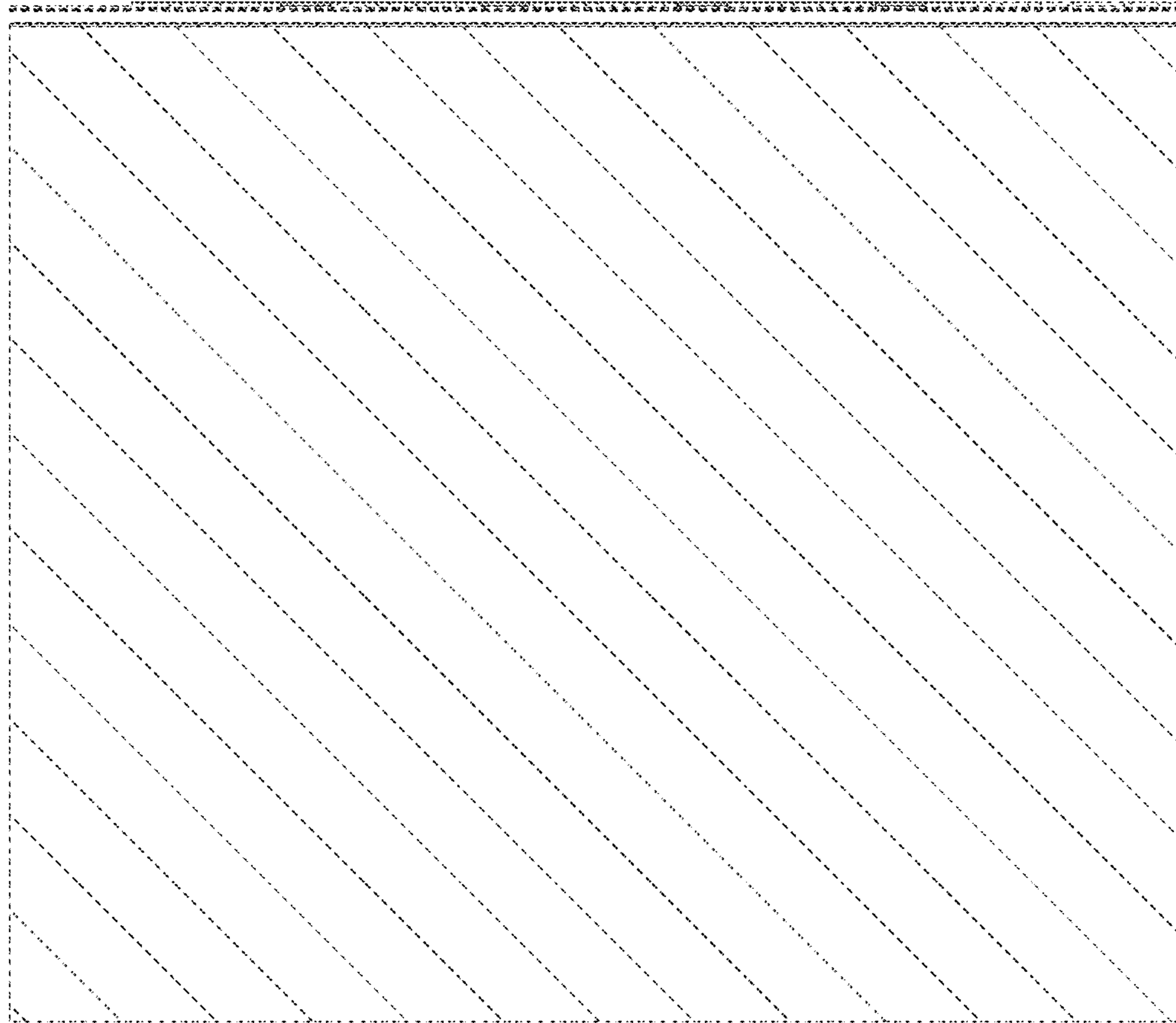

FIG. 19

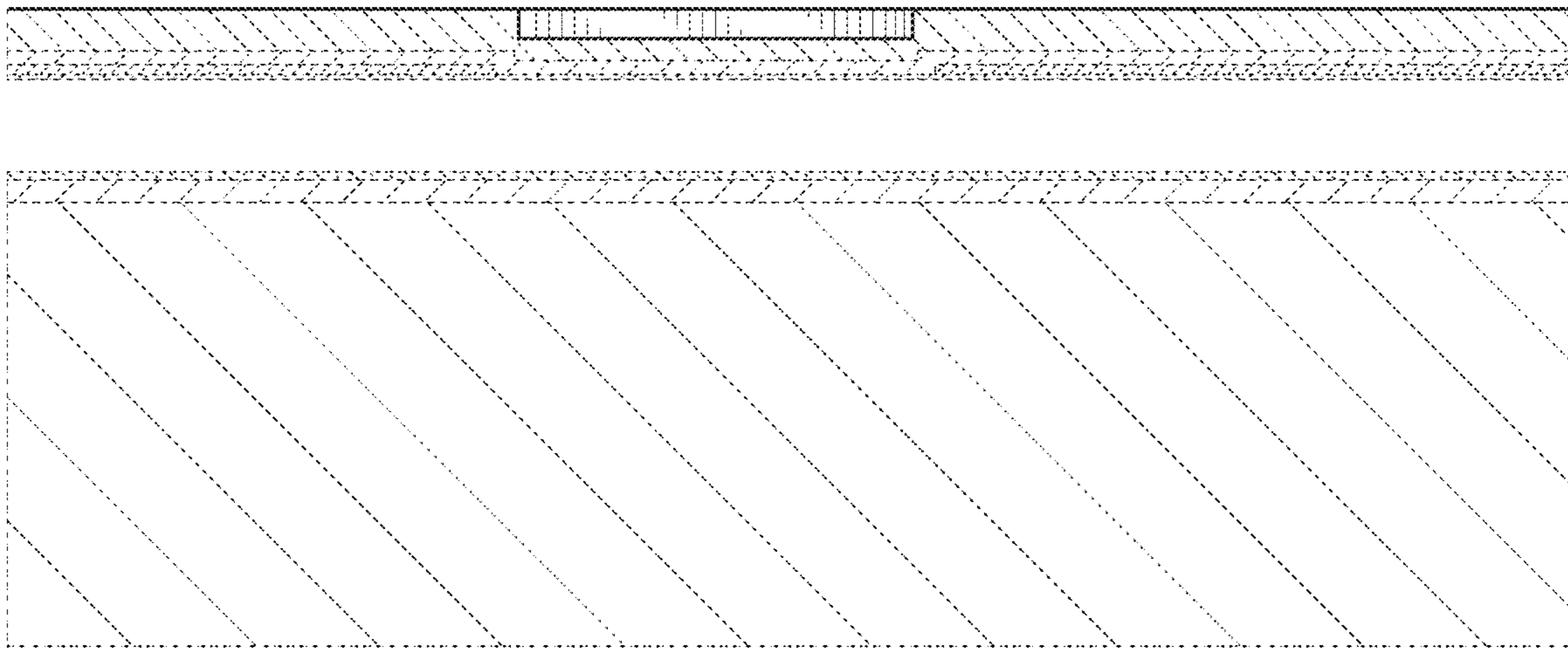

FIG. 20

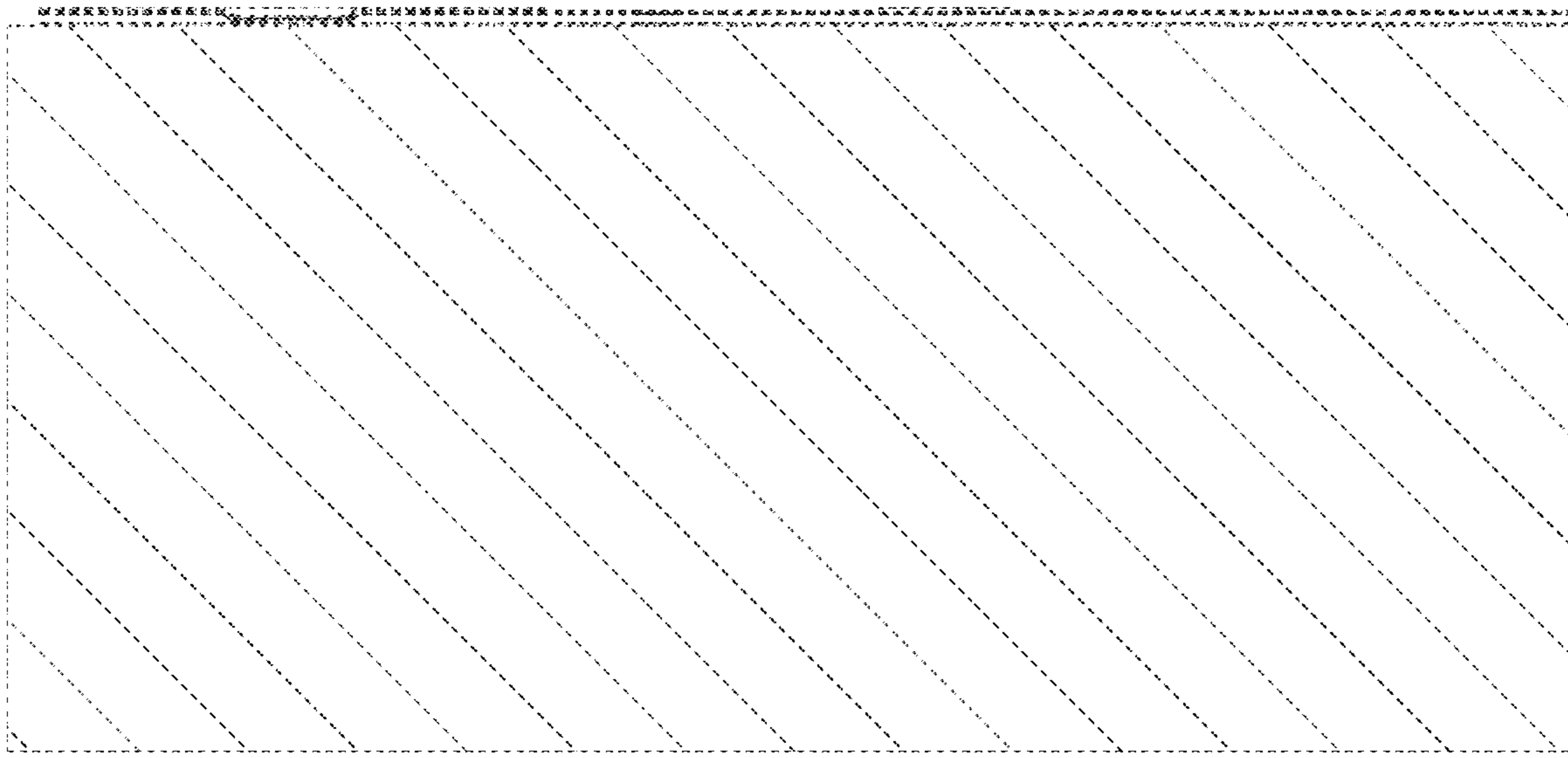

FIG. 21

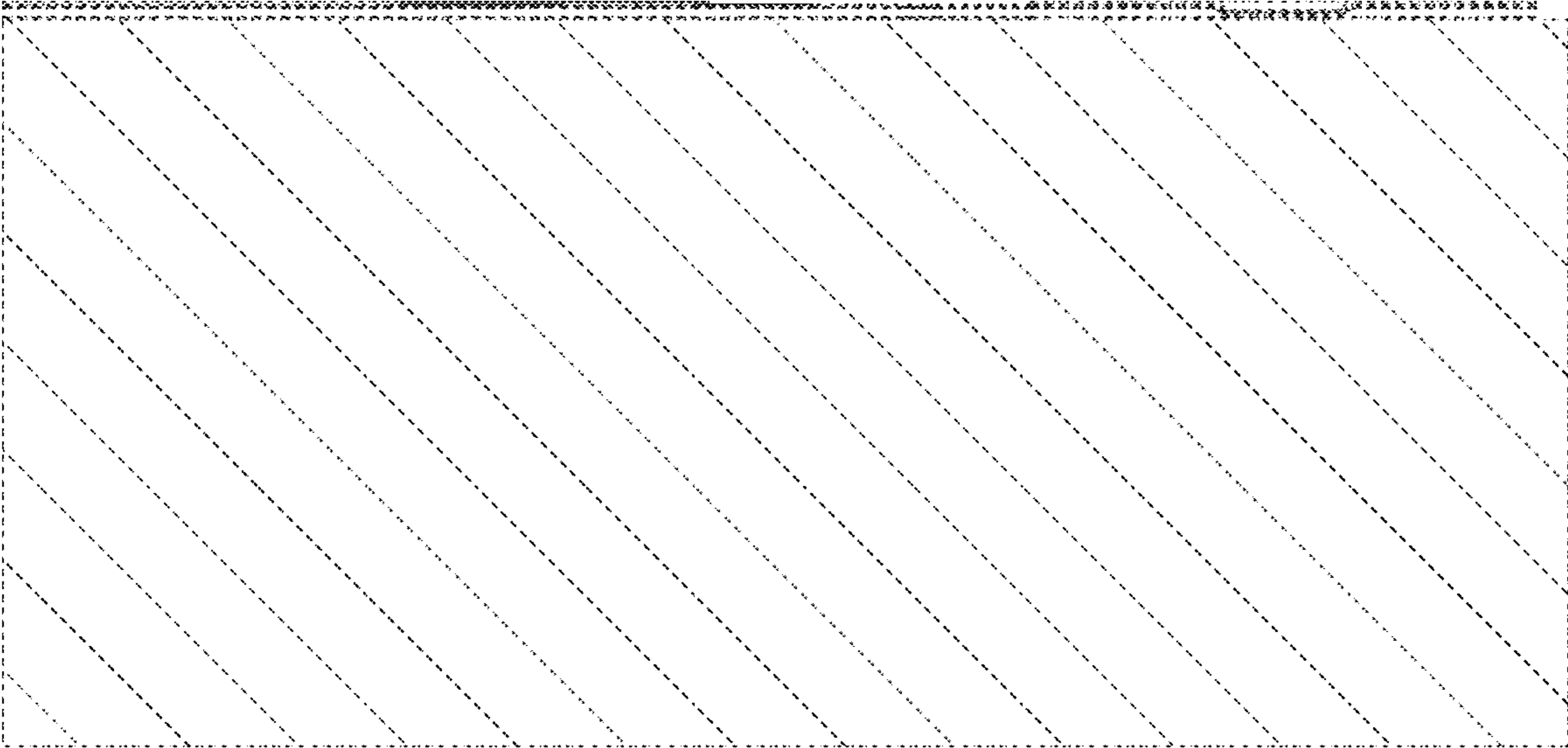

FIG. 22