



US00D884476S

(12) **United States Design Patent**  
**Son**

(10) **Patent No.:** **US D884,476 S**

(45) **Date of Patent:** **\*\* May 19, 2020**

(54) **CONTAINER FOR COSMETICS**

(71) Applicant: **YONWOO CO., LTD.**, Incheon (KR)

(72) Inventor: **Su Jin Son**, Incheon (KR)

(73) Assignee: **YONWOO CO., LTD.**, Incheon (KR)

(\*\*) Term: **15 Years**

(21) Appl. No.: **29/654,811**

(22) Filed: **Jun. 27, 2018**

(30) **Foreign Application Priority Data**

Apr. 25, 2018 (KR) ..... 30-2018-0019497

(51) **LOC (12) Cl.** ..... **09-01**

(52) **U.S. Cl.**  
USPC ..... **D9/503**; D9/448; D9/454

(58) **Field of Classification Search**  
USPC ..... D9/434-435, 454, 500, 503-505, 516,  
D9/530, 537, 539, 549, 558, 682,  
D9/690-691, 715, 719; D6/542;  
D24/224; D27/183, 186, 189-191;  
D28/76, 88

CPC ..... B65D 1/00; B65D 1/02; B65D 1/0223;  
B65D 23/00; B65D 51/32; B65D  
2501/00; B65D 2501/0009

See application file for complete search history.

(56) **References Cited**

**U.S. PATENT DOCUMENTS**

D208,885 S \* 10/1967 Roehrich ..... D9/503  
D355,601 S \* 2/1995 Buettner ..... D9/503  
D362,187 S \* 9/1995 Thompson ..... D9/500

D365,759 S \* 1/1996 Otani ..... D9/504  
D416,154 S \* 11/1999 Diehl ..... D6/542  
D654,363 S \* 2/2012 Baek ..... D9/504  
D677,583 S \* 3/2013 In ..... D9/503  
D707,133 S \* 6/2014 In ..... D9/691  
D711,748 S \* 8/2014 Hwang ..... D9/691  
D718,136 S \* 11/2014 Harrity ..... D9/499  
D816,203 S \* 4/2018 Valentino ..... D23/366  
D832,710 S \* 11/2018 Kim ..... D9/529  
2015/0020836 A1 \* 1/2015 Ramet ..... A45D 34/045  
132/200

\* cited by examiner

*Primary Examiner* — Dana Meyrow

(74) *Attorney, Agent, or Firm* — Novick, Kim & Lee,  
PLLC; Sang Ho Lee; Hyun Woo Shin

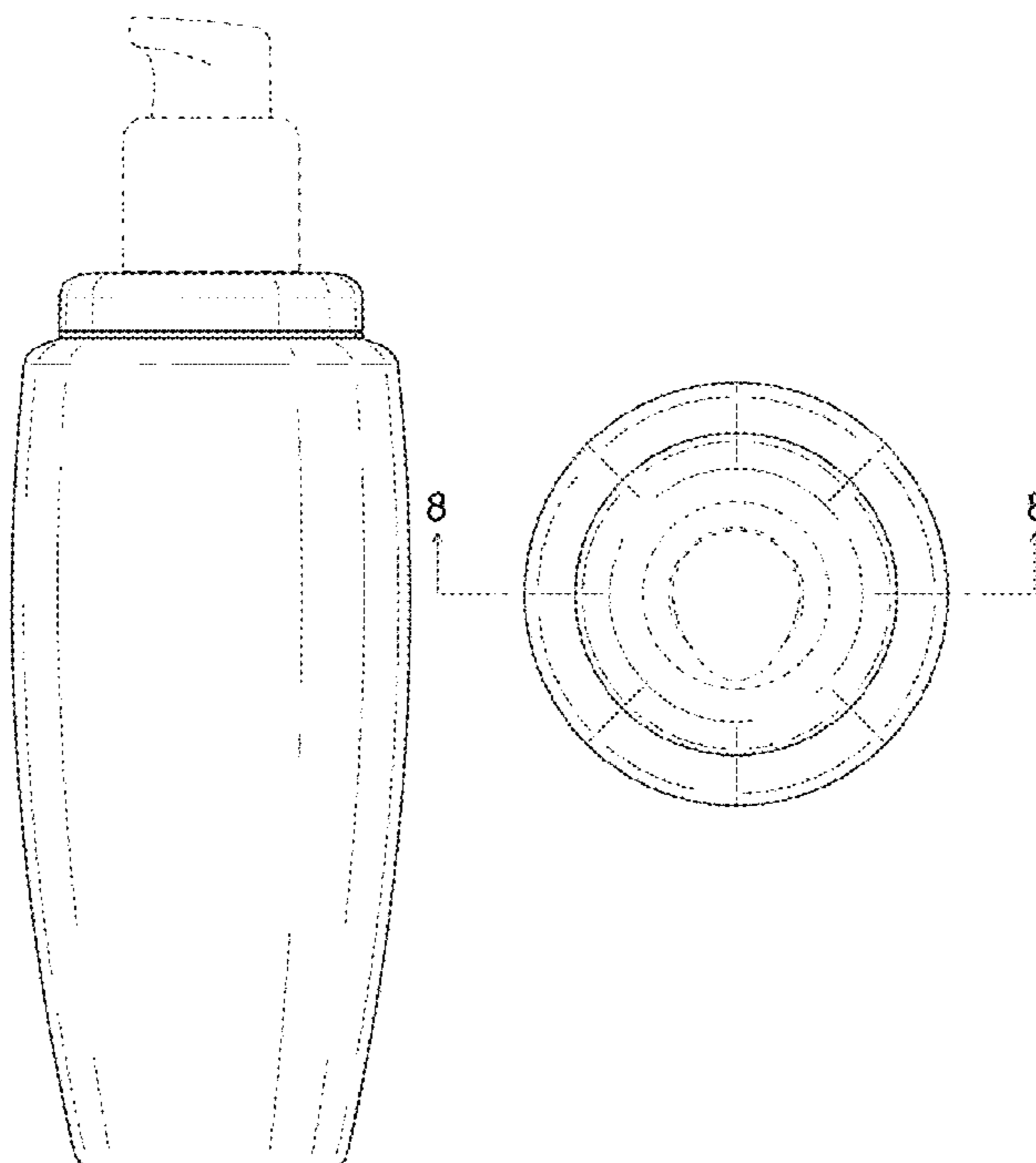
(57) **CLAIM**

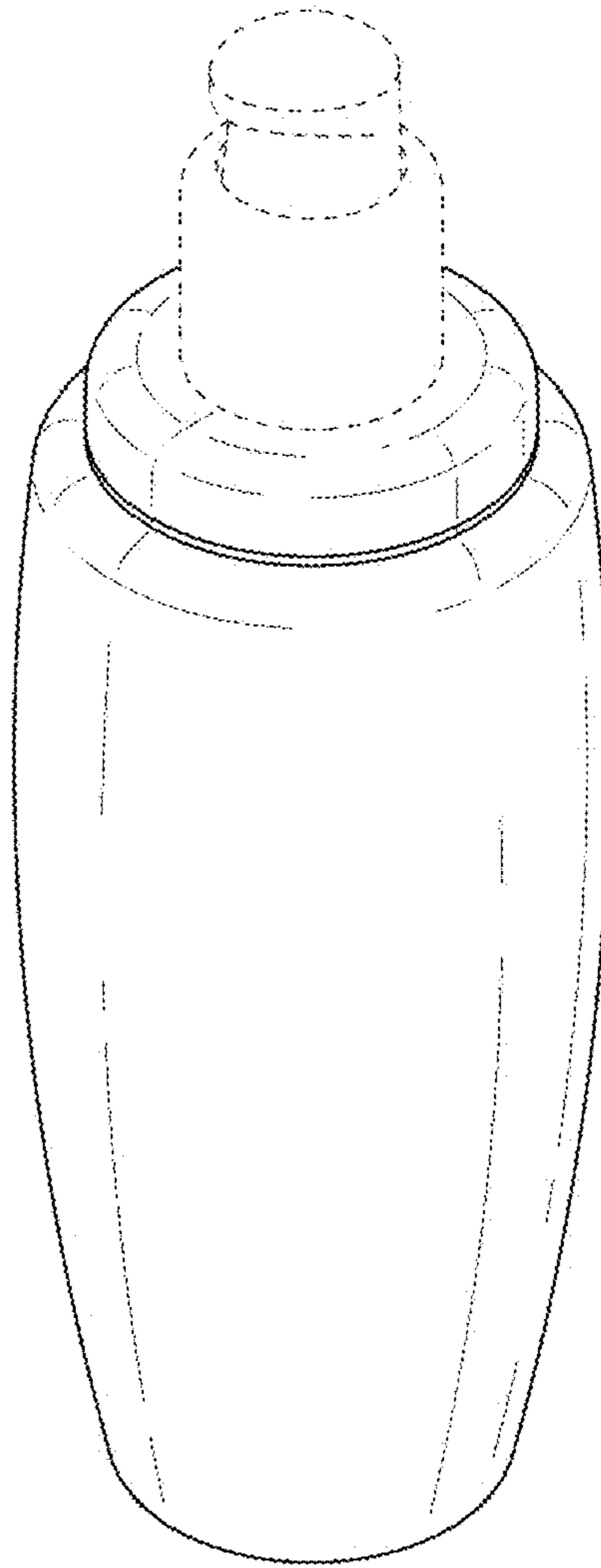
I claim the ornamental design for a container for cosmetics,  
as shown and described.

**DESCRIPTION**

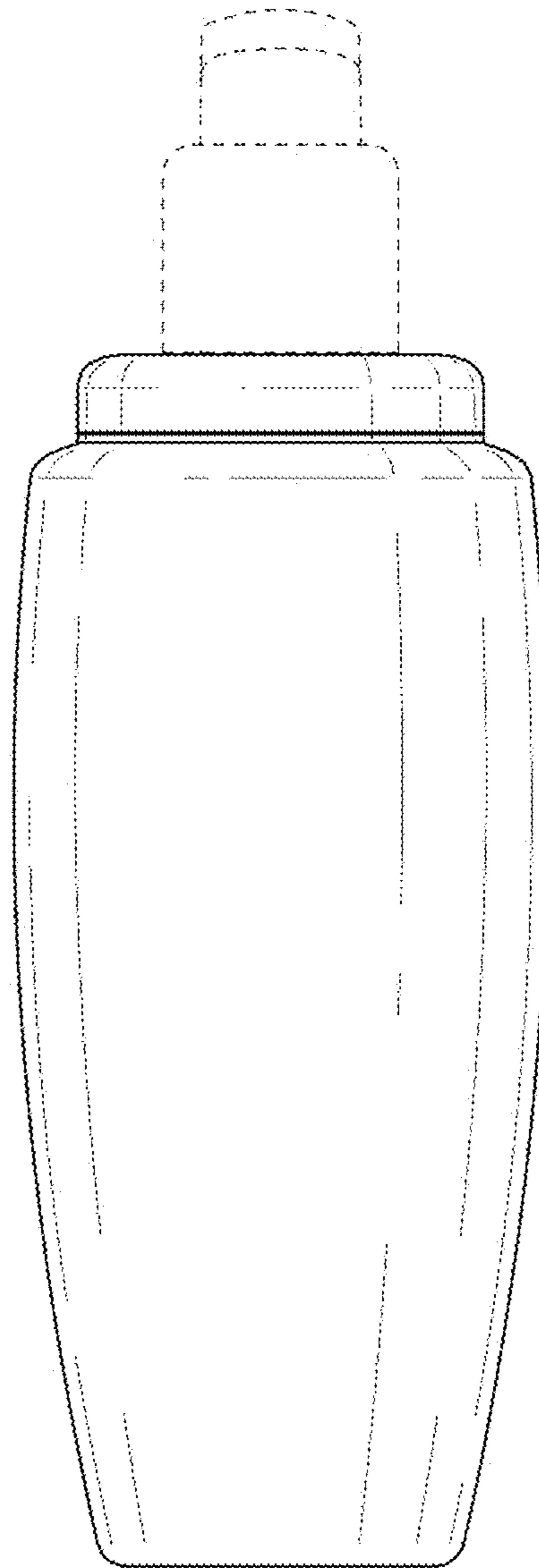
FIG. 1 is a perspective view of a container for cosmetics,  
showing my new design;  
FIG. 2 is a front elevational view thereof;  
FIG. 3 is a rear elevational view thereof;  
FIG. 4 is a left side elevational view thereof;  
FIG. 5 is a right side elevational view thereof;  
FIG. 6 is a top plan view thereof;  
FIG. 7 is a bottom plan view thereof; and,  
FIG. 8 is a sectional view of taken along line 8-8 of FIG. 6,  
and shows a cylindrical inner container in broken lines.  
The broken lines in the drawings illustrate the portions of the  
container for cosmetics that form no part of the claimed  
design.

**1 Claim, 7 Drawing Sheets**

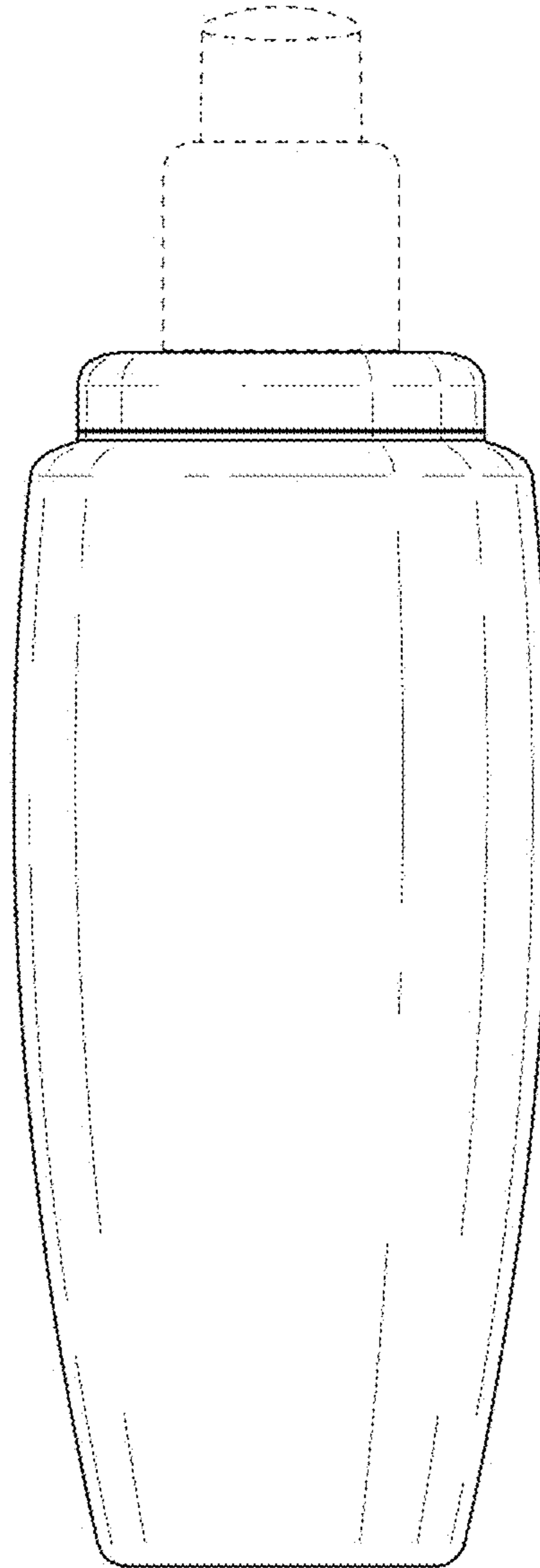




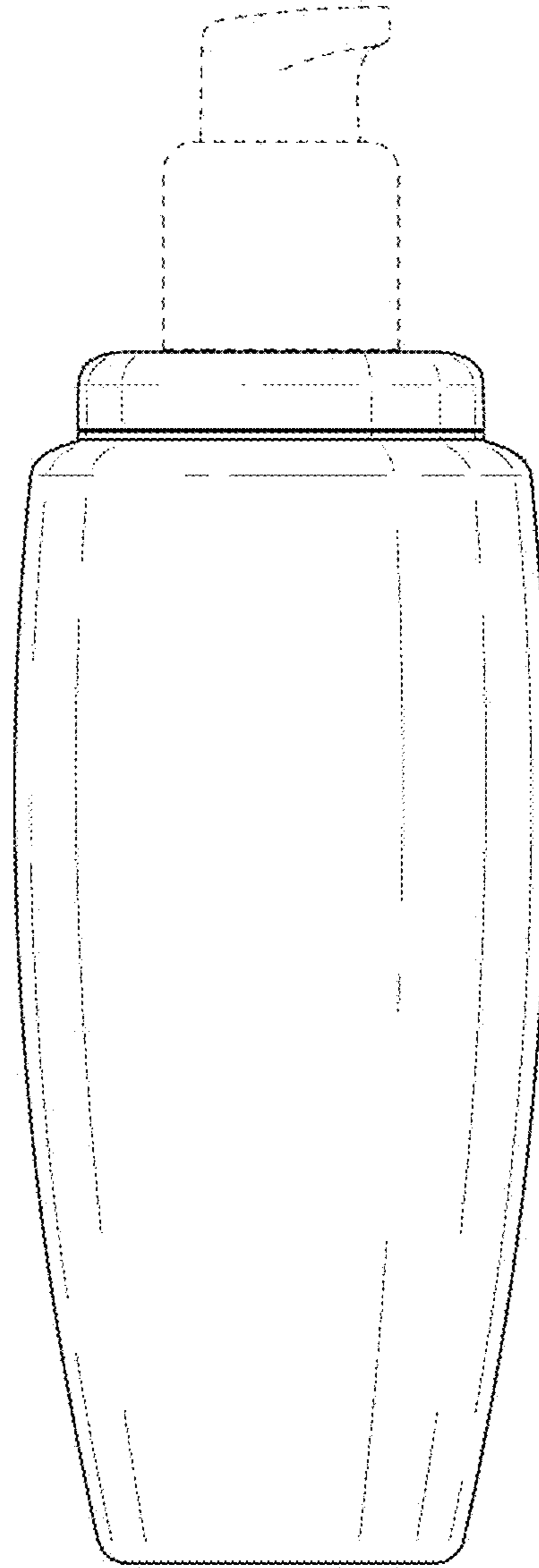
**FIG. 1**



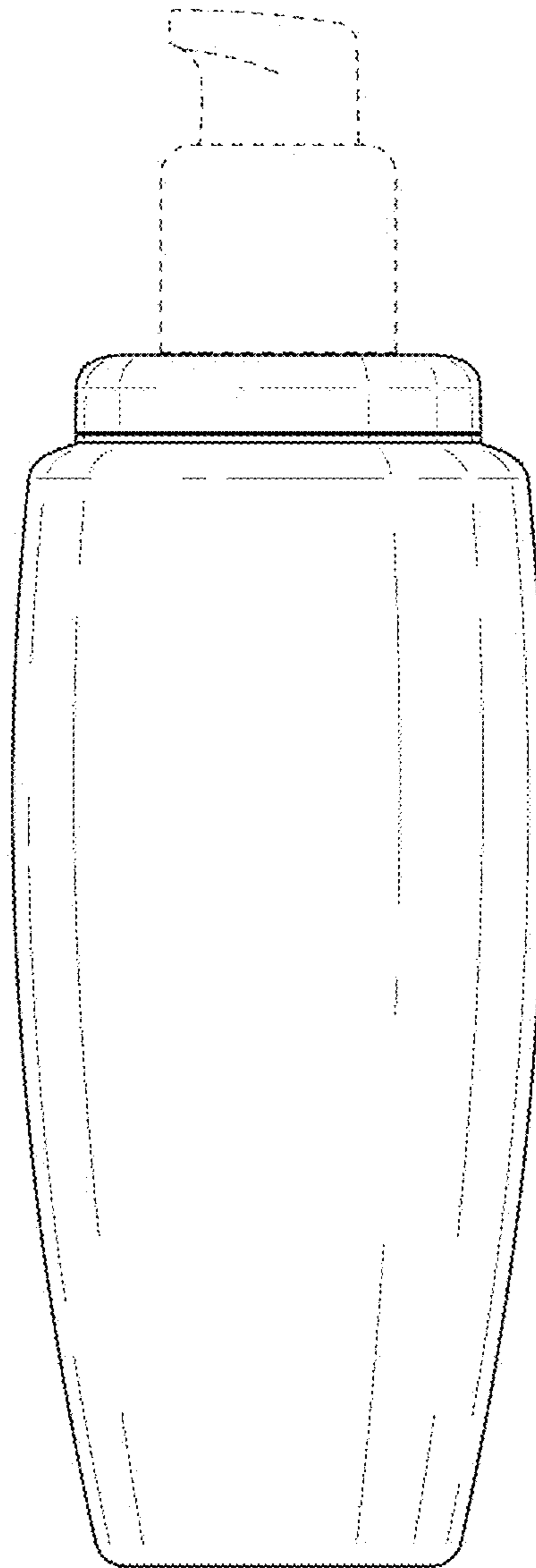
**FIG. 2**



**FIG. 3**



**FIG. 4**



**FIG. 5**

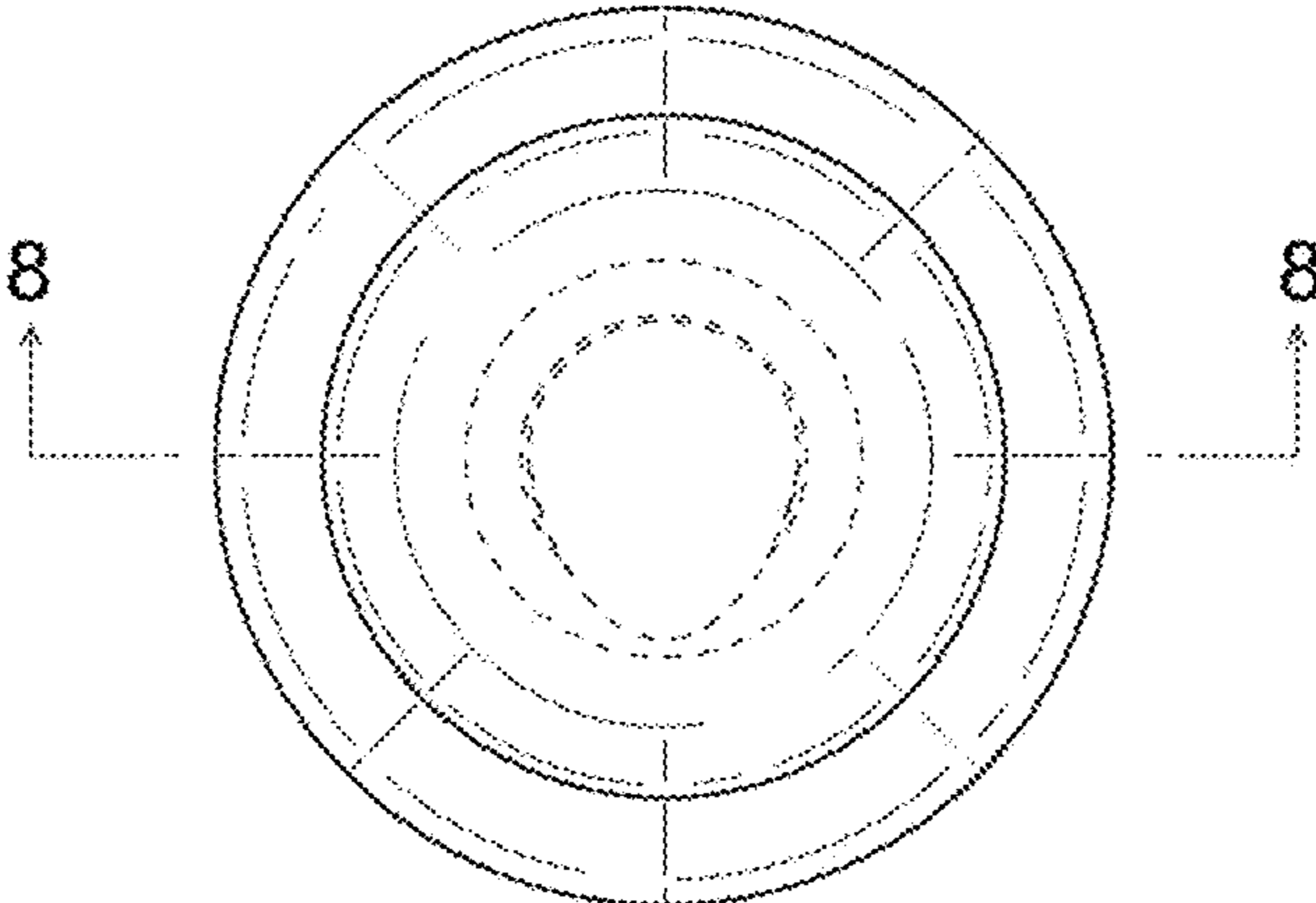


FIG. 6

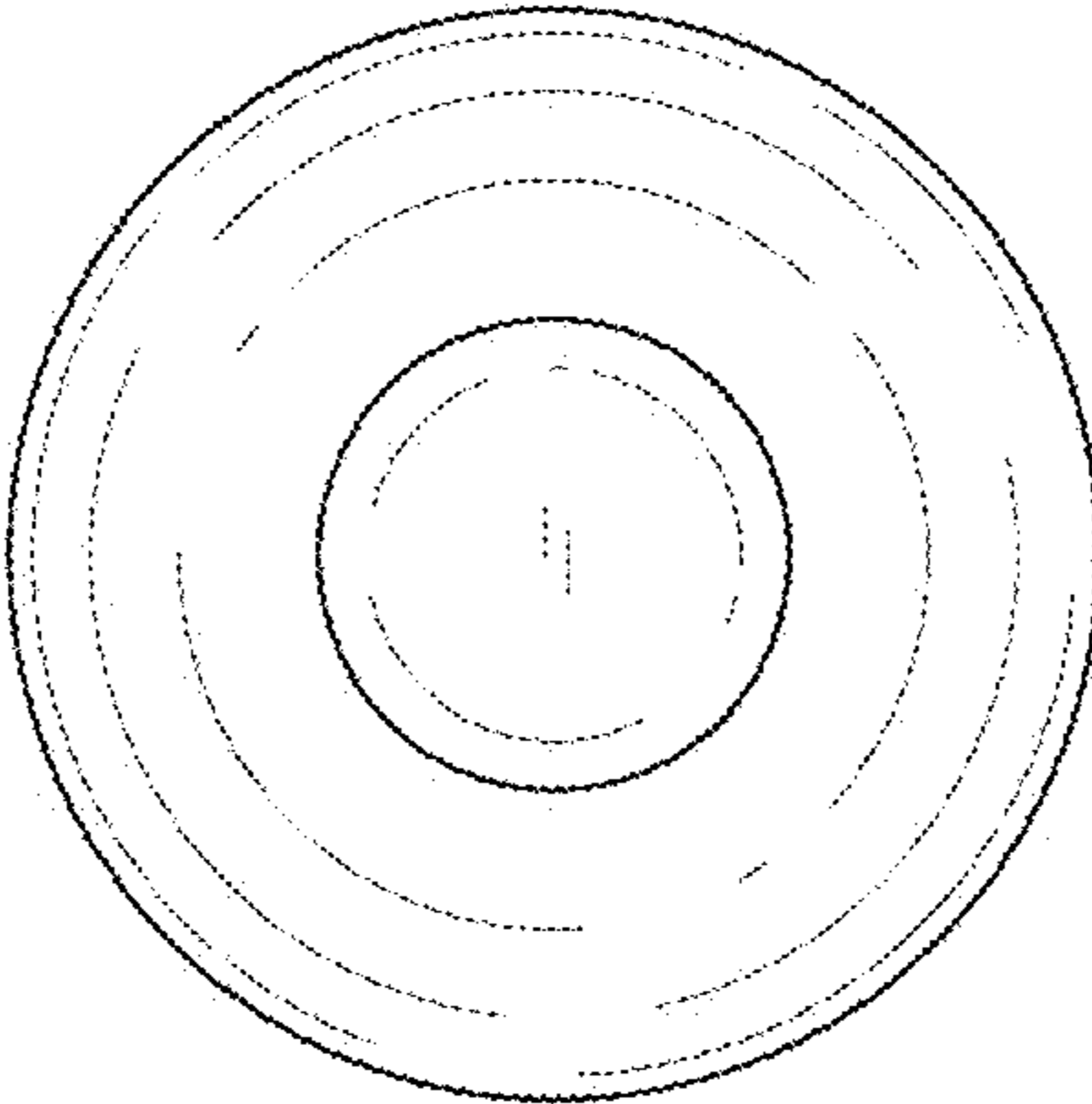


FIG. 7

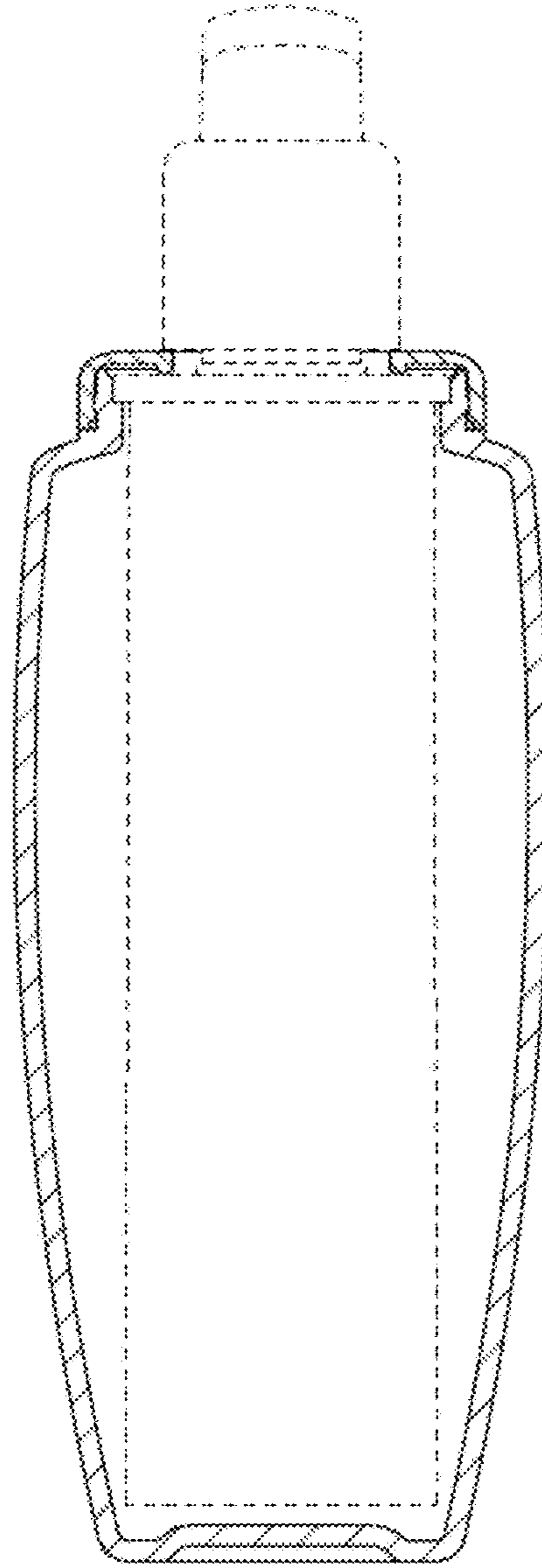


FIG. 8