



US00D884451S

(12) **United States Design Patent**
Li

(10) **Patent No.:** **US D884,451 S**

(45) **Date of Patent:** **** May 19, 2020**

(54) **PORTABLE METAL KNIFE SHARPENER**

(71) Applicant: **ChaoWu Li**, Qidong (CN)

(72) Inventor: **ChaoWu Li**, Qidong (CN)

(**) Term: **15 Years**

(21) Appl. No.: **29/706,259**

(22) Filed: **Sep. 19, 2019**

(51) **LOC (12) Cl.** **08-05**

(52) **U.S. Cl.**
USPC **D8/93**

(58) **Field of Classification Search**
USPC D8/90, 91, 92, 93
CPC B24D 15/081; B24D 15/04; B24D 15/00;
B24D 15/06; B24D 15/08

See application file for complete search history.

(56) **References Cited**

U.S. PATENT DOCUMENTS

4,530,188	A *	7/1985	Graves	B24D 15/081 451/461
D280,380	S *	9/1985	Graves	D8/91
4,934,110	A *	6/1990	Juranitch	B24D 15/081 451/486
5,040,435	A *	8/1991	Millman	B24D 15/081 451/486
5,440,953	A *	8/1995	Gangelhoff	B24D 15/081 451/486
5,478,272	A *	12/1995	Cozzini	B24D 15/081 451/486
6,769,326	B2 *	8/2004	Bodard	B24D 15/081 451/486
6,866,569	B2 *	3/2005	Cozzini	B24D 15/081 451/319

6,905,403	B2 *	6/2005	Stallegger	B24D 15/081 451/45
7,503,241	B2 *	3/2009	Dassaud	B24D 15/081 451/486
D662,385	S	6/2012	Kuo		
9,545,703	B1 *	1/2017	Juranitch	B24D 15/081
D826,667	S	8/2018	Skeuse et al.		
D838,158	S	1/2019	Wu		
2004/0014415	A1 *	1/2004	Stallegger	B24D 15/081 451/555
2004/0097179	A1 *	5/2004	Cozzini	B24D 15/081 451/378

* cited by examiner

Primary Examiner — Philip S Hyder

(74) *Attorney, Agent, or Firm* — HYIP

(57) **CLAIM**

The ornamental design for a portable metal knife sharpener, as shown and described.

DESCRIPTION

FIG. 1 is a perspective view of a portable metal knife sharpener showing my new design; FIG. 2 is a front view thereof; FIG. 3 is a back view thereof; FIG. 4 is a left side view thereof; FIG. 5 is a right side view thereof; FIG. 6 is a top view thereof; and, FIG. 7 is a bottom view thereof. The broken lines shown in the drawings depict portions of the portable metal knife sharpener in which the design is embodied that form no part of the claimed design.

1 Claim, 7 Drawing Sheets

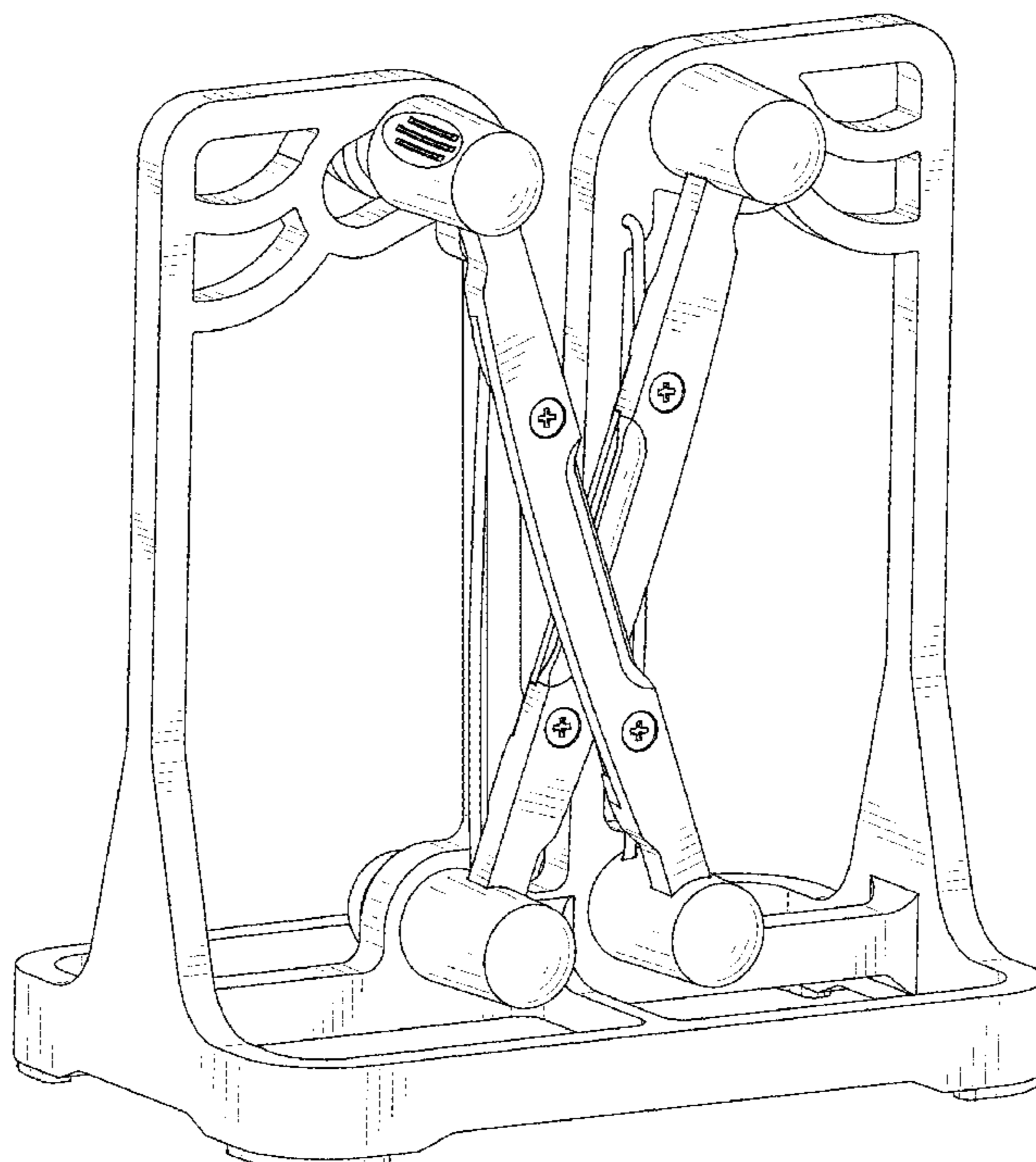

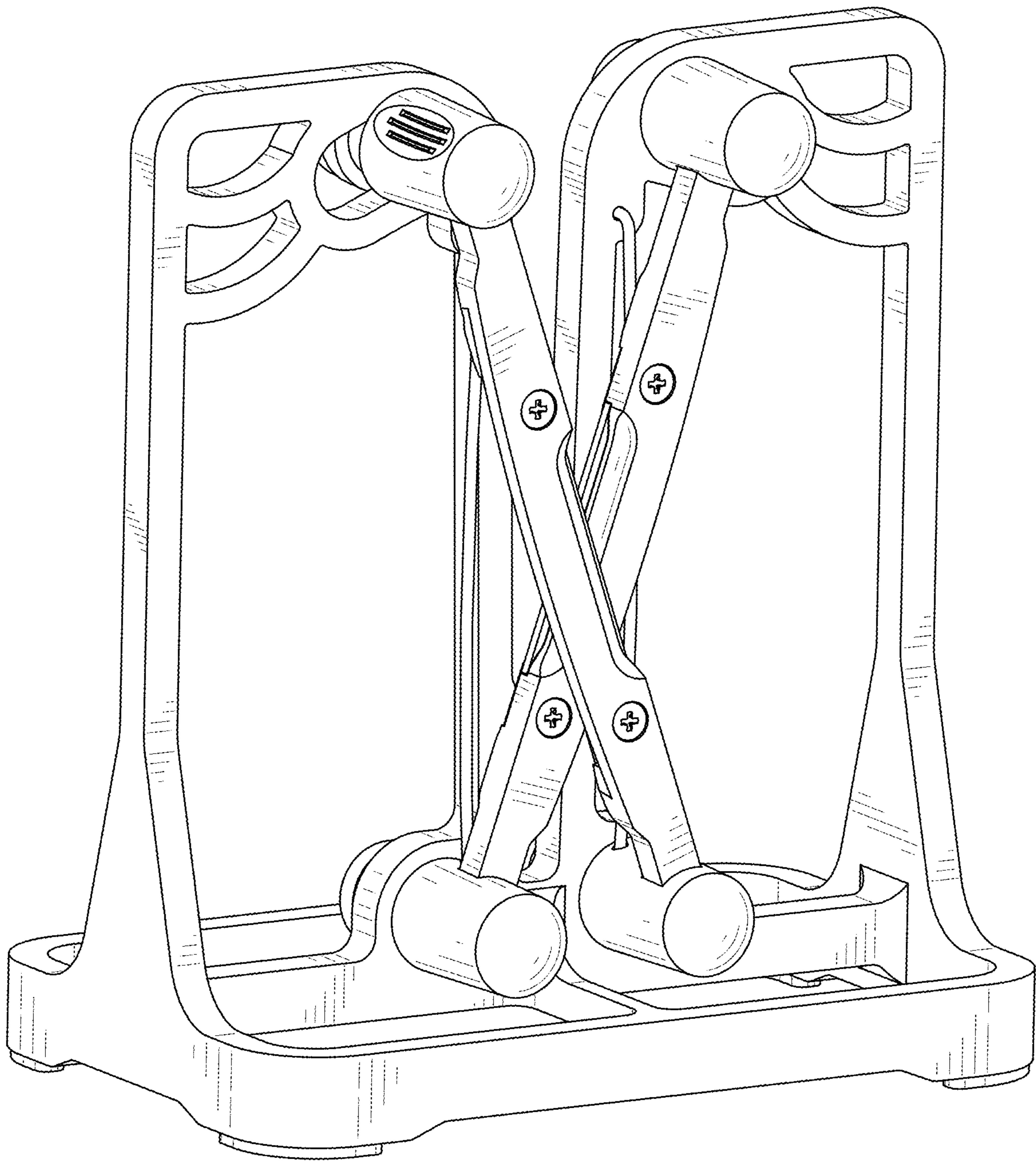

FIG. 1

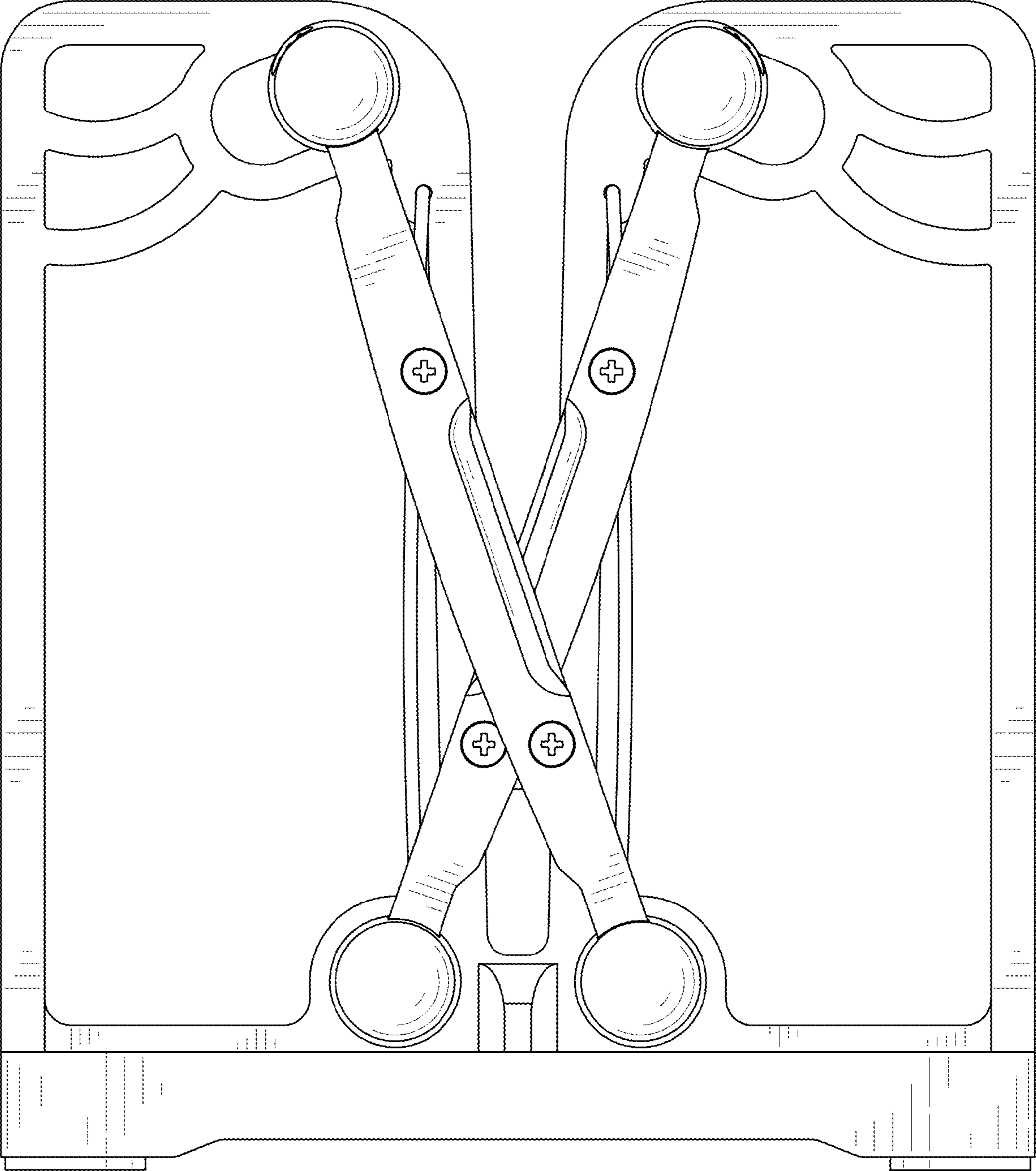

FIG. 2

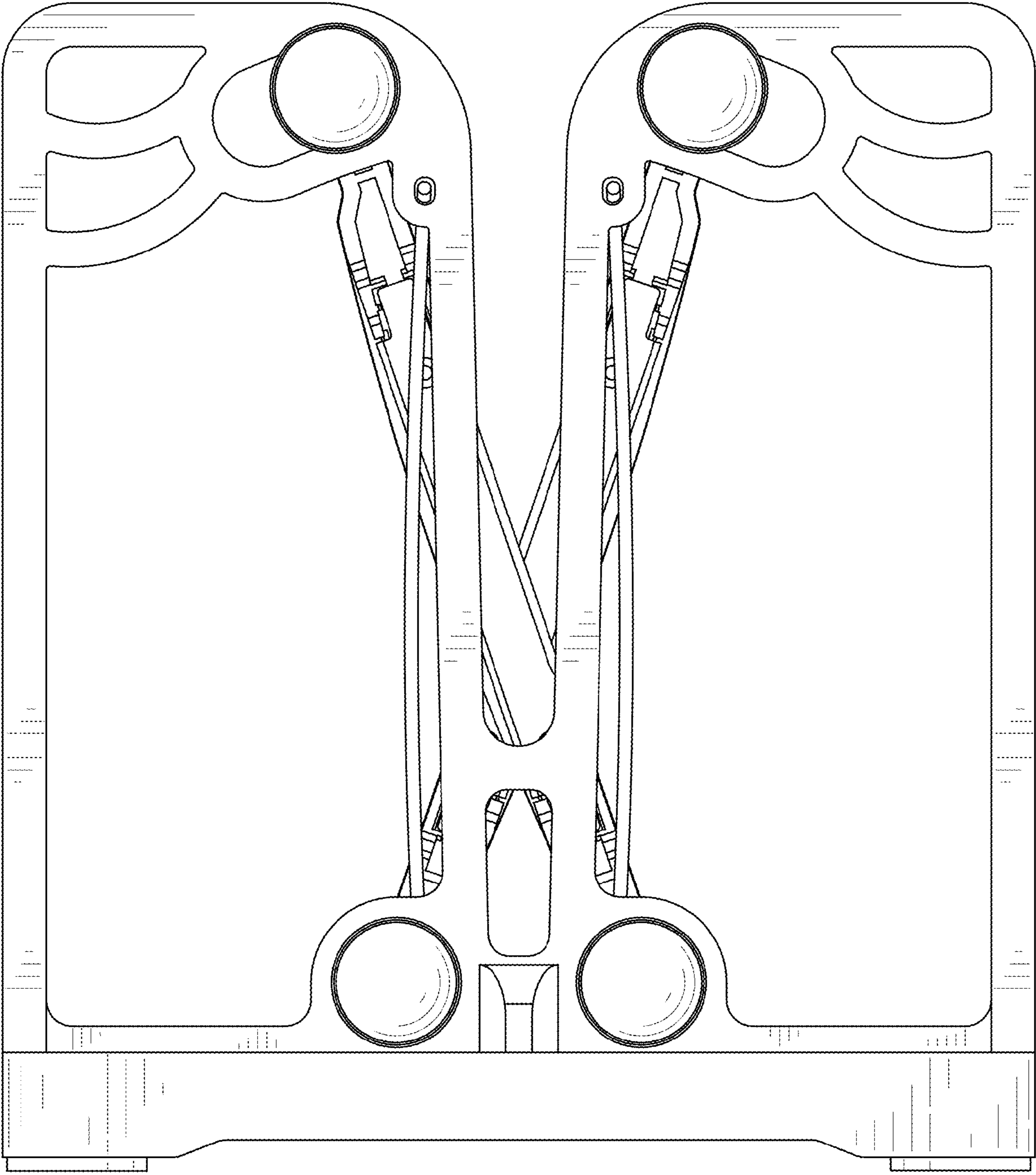

FIG. 3

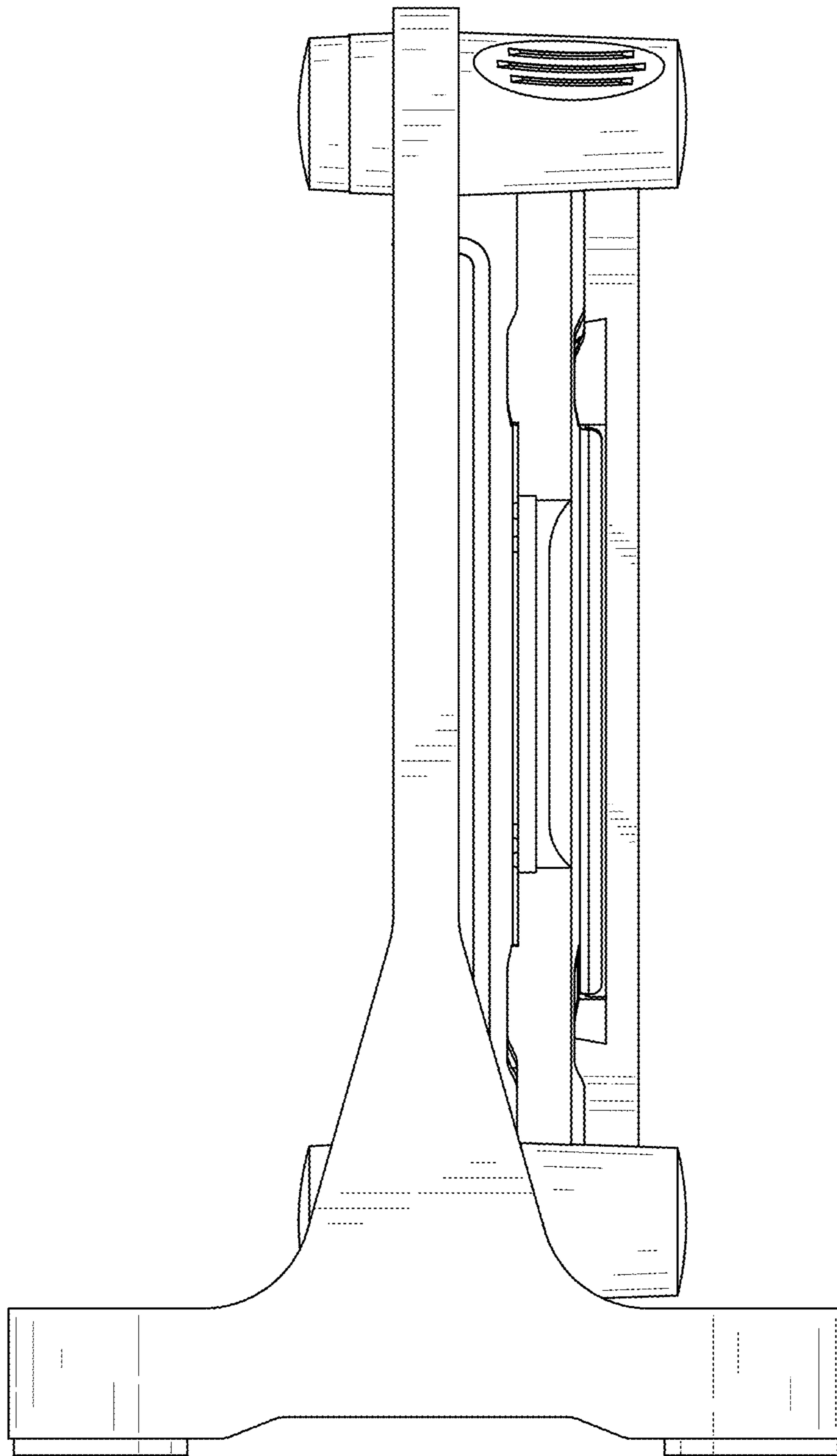

FIG. 4

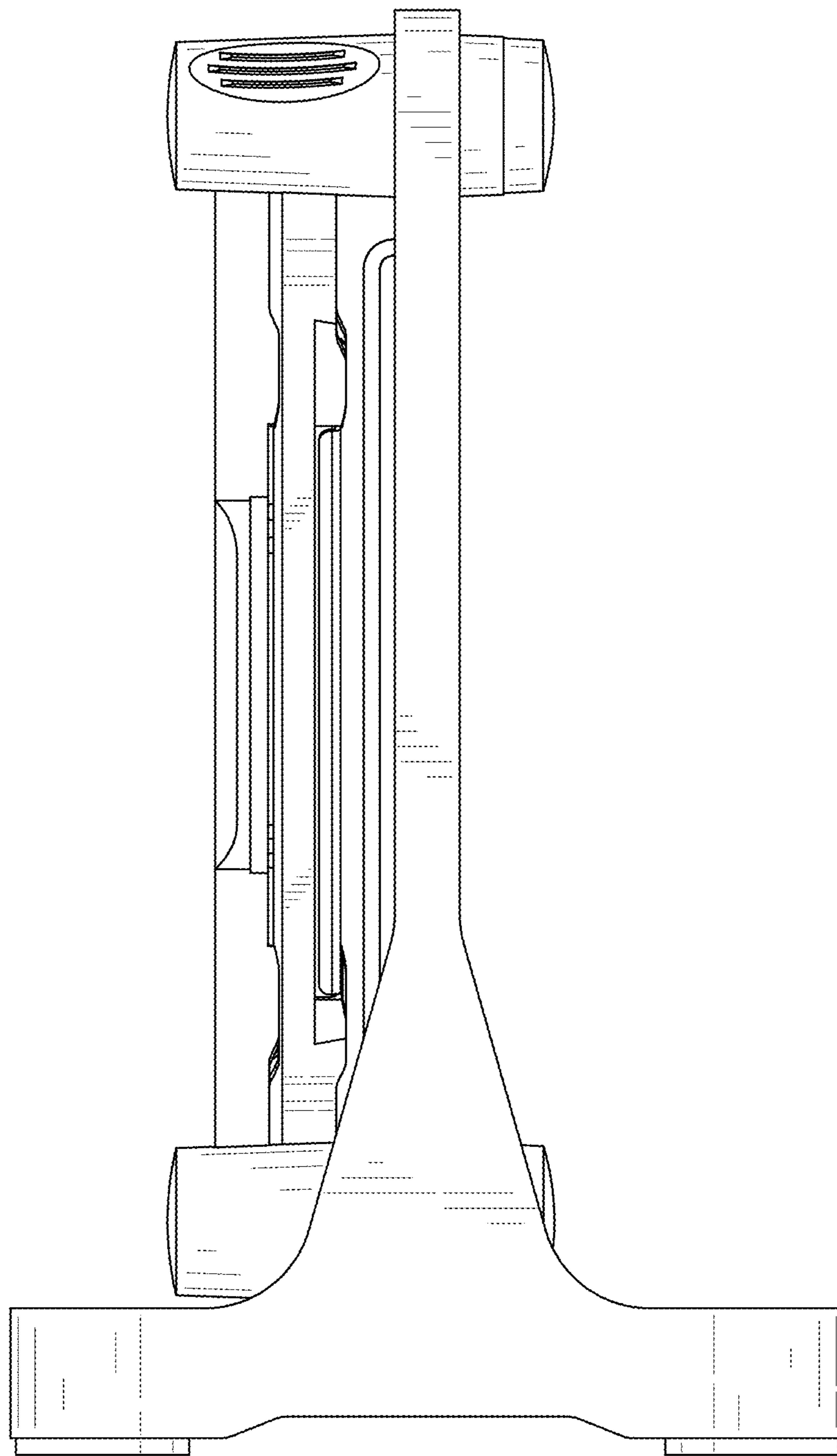

FIG. 5

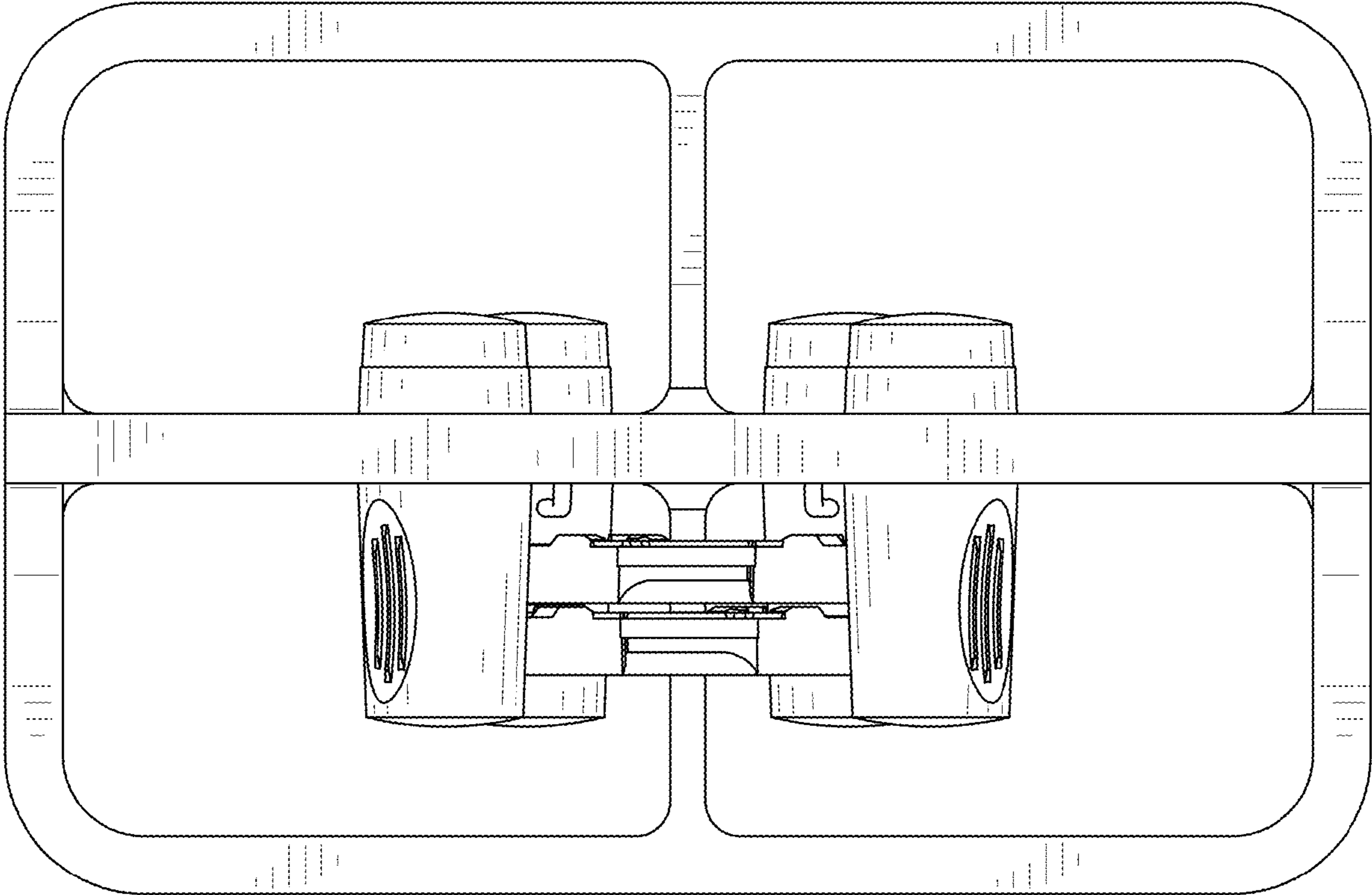

FIG. 6

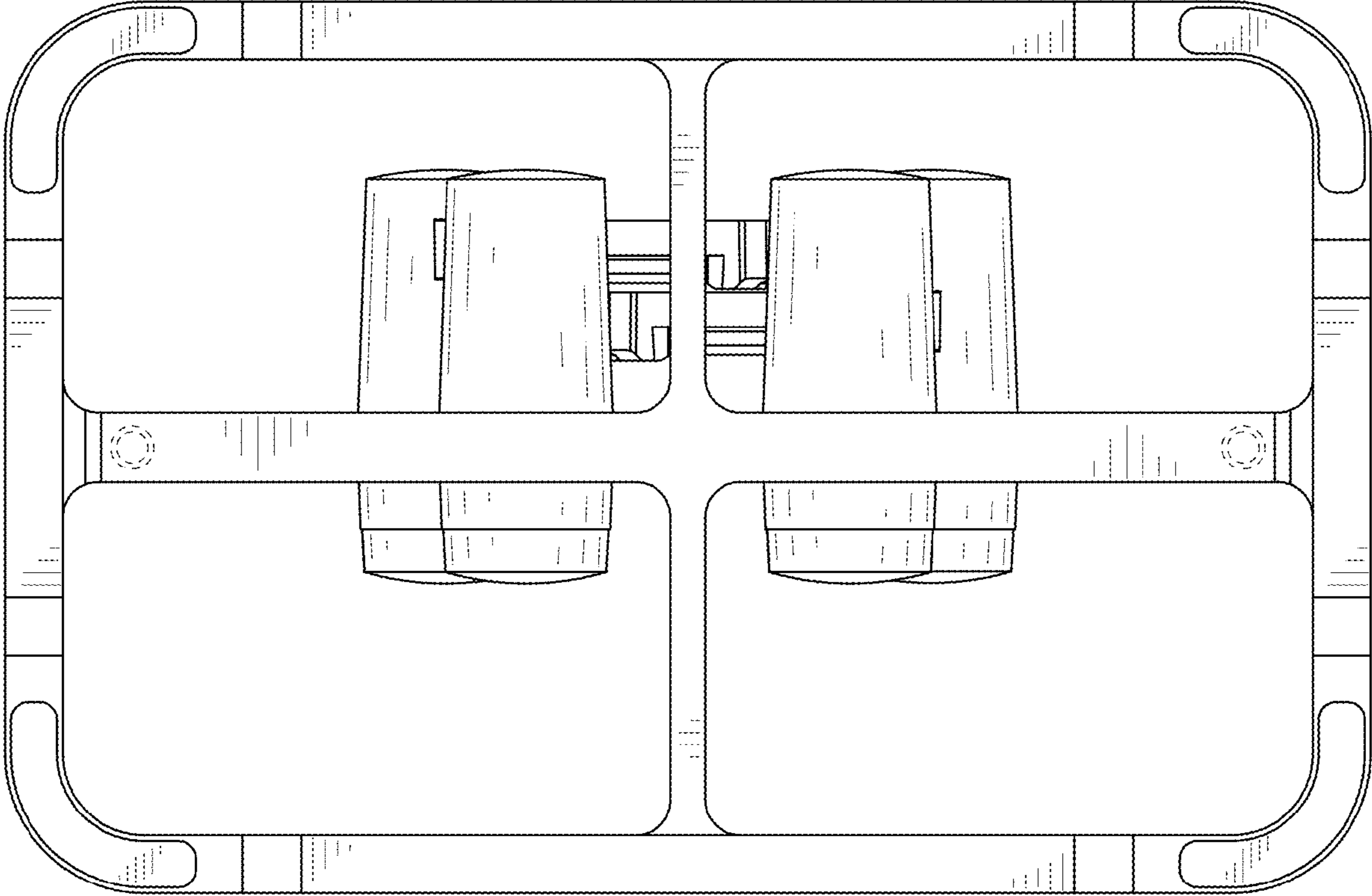

FIG. 7