



US00D884444S

(12) **United States Design Patent** (10) **Patent No.:** **US D884,444 S**
Kaye, Jr. et al. (45) **Date of Patent:** **** *May 19, 2020**

- (54) **OSCILLATING SAW BLADE**
- (71) Applicant: **BLACK & DECKER, INC.**, New Britain, CT (US)
- (72) Inventors: **Thomas R. Kaye, Jr.**, Bel Air, MD (US); **James R. Niblett**, Columbia, MD (US)
- (73) Assignee: **BLACK & DECKER INC.**, New Britain, CT (US)
- (*) Notice: This patent is subject to a terminal disclaimer.
- (**) Term: **15 Years**
- (21) Appl. No.: **29/664,688**
- (22) Filed: **Sep. 27, 2018**

Related U.S. Application Data

- (60) Division of application No. 29/525,056, filed on Apr. 27, 2015, now Pat. No. Des. 832,666, which is a continuation of application No. 29/447,173, filed on Mar. 1, 2013, now abandoned, which is a continuation-in-part of application No. 13/385,614, filed on Jul. 16, 2012, now Pat. No. 9,073,195.
- (51) **LOC (12) Cl.** **08-03**
- (52) **U.S. Cl.**
USPC **D8/20; D8/382**
- (58) **Field of Classification Search**
USPC D8/9, 16, 19, 20, 61, 64, 70, 382; D15/127, 133, 138
CPC . B23B 31/10; B24B 23/04; B25F 3/00; B25F 5/00; B27B 5/29; B27B 5/30; B27B 19/006; A61B 17/14
See application file for complete search history.

(56) **References Cited**
U.S. PATENT DOCUMENTS

694,597 A 3/1902 Wood
2,305,465 A 12/1942 Bangser
(Continued)

FOREIGN PATENT DOCUMENTS

AU 2006305634 4/2007
CH 657411 A5 8/1986
(Continued)

OTHER PUBLICATIONS

Zimmer Inc., Brochure "Air Drive Blades—The Next Generation" dated Jun. 28, 1993, 1 page; © 1993 Zimmer, Inc.
(Continued)

Primary Examiner — Sandra S Snapp
Assistant Examiner — Ieisha N Price
(74) *Attorney, Agent, or Firm* — Scott B. Markow

(57) **CLAIM**

The ornamental design for an oscillating saw blade, as shown and described.

DESCRIPTION

FIG. 1 is a perspective view of an oscillating saw blade. FIG. 2 is a left view of the oscillating saw blade of FIG. 1. FIG. 3 is a right view of the oscillating saw blade of FIG. 1. FIG. 4 is a front view of the oscillating saw blade of FIG. 1. FIG. 5 is a rear view of the oscillating saw blade of FIG. 1. FIG. 6 is a top view of the oscillating saw blade of FIG. 1; and, FIG. 7 is a bottom view of the oscillating saw blade of FIG. 1. The broken lines in the drawings illustrate portions of the oscillating saw blade and form no part of the claimed design.

1 Claim, 5 Drawing Sheets

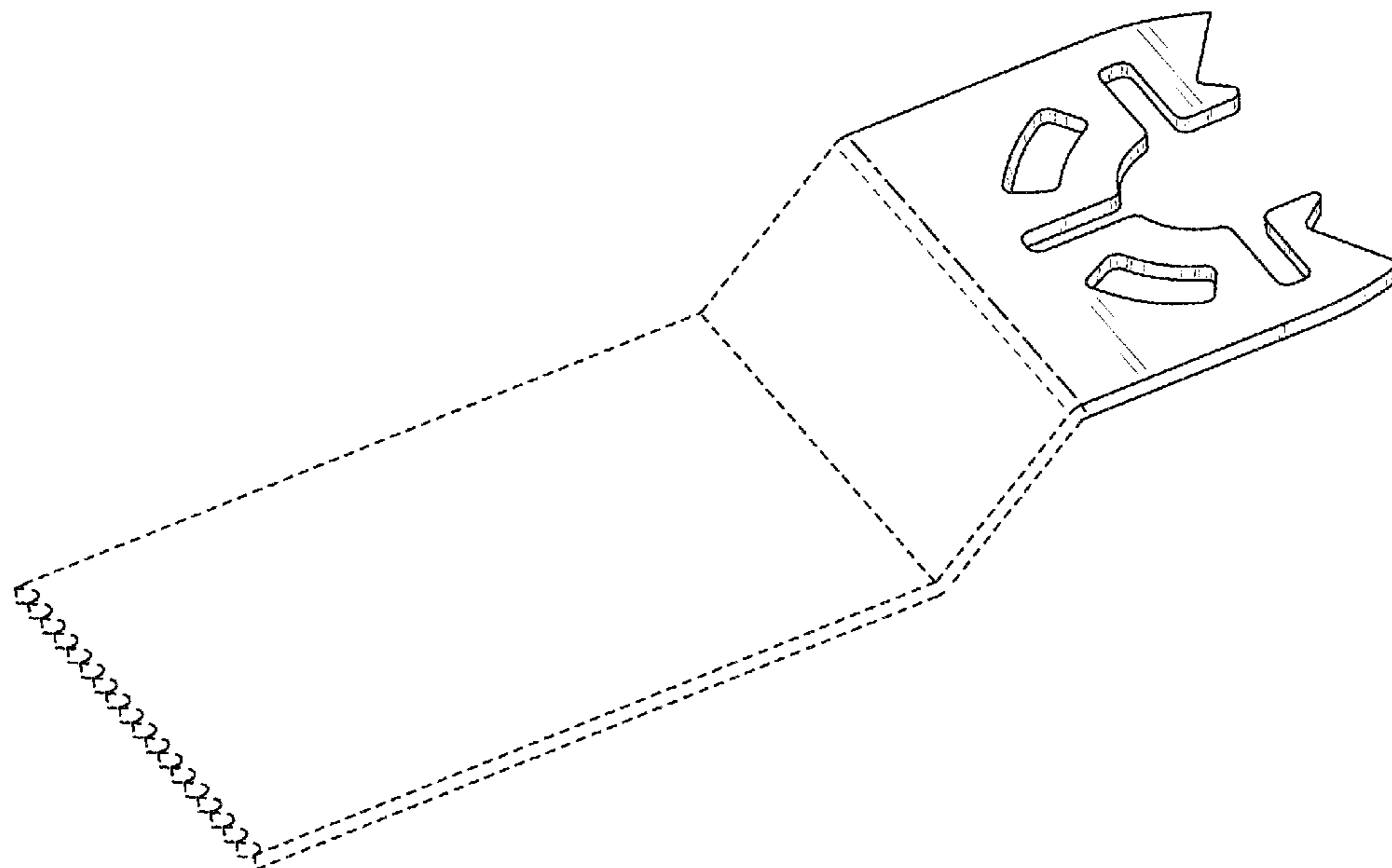

(56)

References Cited

U.S. PATENT DOCUMENTS

D137,633 S	4/1944	Jacobsen	5,729,904 A	3/1998	Trott
2,682,184 A	6/1954	Szarkowski	5,735,866 A	4/1998	Adams et al.
2,693,365 A	11/1954	Zelewsky	D394,315 S	5/1998	Fisher
2,766,791 A	10/1956	Givens	5,785,571 A	7/1998	Camp
2,785,515 A	3/1957	Sansig	5,829,931 A	11/1998	Doumani
2,997,819 A	8/1961	Schact	5,839,196 A	11/1998	Trott
3,055,497 A	9/1962	Klonski	5,848,473 A	12/1998	Brandenburg, Jr.
3,436,875 A	4/1969	Cheney	D404,485 S	1/1999	Hutchins et al.
3,440,915 A	4/1969	Weyant	5,857,237 A	1/1999	Dranginis
3,554,197 A	1/1971	Dobbie	D405,177 S	2/1999	Hutchins et al.
3,656,393 A	4/1972	Goellner	D406,223 S	3/1999	Tran
3,706,474 A	12/1972	Neuenburg	5,957,469 A	9/1999	Miles et al.
3,905,374 A	9/1975	Winter	6,022,353 A	2/2000	Fletcher et al.
3,943,934 A	3/1976	Bent	6,073,939 A	6/2000	Steadings et al.
4,015,371 A	4/1977	Grayston	6,082,515 A	7/2000	Oono et al.
4,059,930 A	11/1977	Alessio	6,099,397 A	8/2000	Wurst
4,106,181 A	8/1978	Mattchen	6,116,996 A	9/2000	Yanase
4,112,541 A	9/1978	Tetradis	6,132,282 A	10/2000	Camp
4,252,121 A	2/1981	Arnegger	6,132,300 A	10/2000	Martin
4,253,776 A	3/1981	Orain	6,179,301 B1	1/2001	Steadings et al.
4,265,285 A	5/1981	Fodor	6,196,554 B1	3/2001	Gaddis et al.
4,386,609 A	6/1983	Mongeon	6,241,259 B1	6/2001	Gaddis et al.
4,393,626 A	7/1983	Schroer	6,340,022 B1	1/2002	Schroer
4,513,742 A	4/1985	Arnegger	D459,805 S	7/2002	Pascaloff
4,590,837 A	5/1986	Nanba	6,430,465 B2	8/2002	Cutler
4,597,227 A	7/1986	Gentischer et al.	6,434,835 B1	8/2002	Grunikiewicz et al.
4,599,077 A	7/1986	Vuillard	6,435,521 B2	8/2002	Steadings et al.
4,648,735 A	3/1987	Oddenino	D462,766 S	9/2002	Jacobs et al.
4,700,478 A	10/1987	Mezger et al.	6,488,287 B2	12/2002	Gaddis et al.
4,784,034 A	11/1988	Stones et al.	6,499,381 B2	12/2002	Ladish et al.
4,825,091 A	4/1989	Breyer et al.	6,503,253 B1	1/2003	Fletcher et al.
4,891,884 A	1/1990	Torbet	6,536,536 B1	3/2003	Gass et al.
4,980,976 A	1/1991	Junginger et al.	6,569,001 B2	5/2003	Rudolf et al.
4,989,374 A	2/1991	Rudolf et al.	6,629,484 B2	10/2003	Soyama et al.
5,022,188 A	6/1991	Borst	6,678,062 B2	1/2004	Haugen et al.
5,027,684 A	7/1991	Neukam	6,705,807 B1	3/2004	Rudolph et al.
5,038,478 A	8/1991	Mezger et al.	6,723,101 B2	4/2004	Fletcher et al.
5,064,325 A	11/1991	McRoskey	D489,823 S	5/2004	Fisher et al.
5,085,589 A	2/1992	Kan	6,747,745 B2	6/2004	Ishikawa et al.
5,107,737 A	4/1992	Tagliaferri	6,796,888 B2	9/2004	Jasch
5,122,142 A	6/1992	Pascaloff	6,802,764 B2	10/2004	Besch
5,157,873 A	10/1992	Rudolf et al.	6,832,764 B2	12/2004	Steadings et al.
5,199,223 A	4/1993	Rudolf et al.	6,834,730 B2	12/2004	Gass et al.
5,219,378 A	6/1993	Arnold	6,865,813 B2	3/2005	Pollak
5,235,719 A	8/1993	Wimberley	6,869,346 B2	3/2005	Wendt et al.
5,263,283 A	11/1993	Rudolf et al.	6,945,862 B2	9/2005	Jasch et al.
5,265,343 A	11/1993	Pascaloff	6,949,110 B2	9/2005	Ark et al.
5,269,784 A	12/1993	Mast	6,968,933 B2	11/2005	Buckhouse et al.
D343,247 S	1/1994	Walen	7,001,403 B2	2/2006	Hausmann et al.
5,303,688 A	4/1994	Chiuminatta et al.	7,015,445 B2	3/2006	Bishop
5,306,025 A	4/1994	Langhoff	7,077,735 B2	7/2006	Krondorfer et al.
5,306,285 A	4/1994	Miller et al.	7,093,668 B2	8/2006	Gass et al.
5,309,805 A	5/1994	Mezger et al.	7,107,691 B2	9/2006	Nottingham et al.
5,352,229 A	10/1994	Goble et al.	7,115,027 B2	10/2006	Thomaschewski
5,366,312 A	11/1994	Raines	7,121,358 B2	10/2006	Gass et al.
5,382,249 A	1/1995	Fletcher	7,128,503 B2	10/2006	Steadings et al.
5,423,825 A	6/1995	Levine	7,169,025 B2	1/2007	Schumacher
5,435,063 A	7/1995	Russo	7,175,625 B2	2/2007	Culbert
D360,946 S	8/1995	Goris	7,189,239 B2	3/2007	Fisher et al.
5,440,811 A	8/1995	Challis	7,207,873 B2	4/2007	Hesse et al.
D362,065 S	9/1995	Goris	7,217,177 B2	5/2007	Frech et al.
5,468,176 A	11/1995	Udert et al.	D544,007 S	6/2007	Marasco
5,468,247 A	11/1995	Matthai et al.	7,225,714 B2	6/2007	Rompel et al.
5,480,507 A	1/1996	Arnold	7,237,988 B2	7/2007	Steadings et al.
5,489,285 A	2/1996	Goris	7,258,351 B2	8/2007	Hoffmann et al.
5,496,316 A	3/1996	Goris	7,258,515 B2	8/2007	Krondorfer
D368,777 S	4/1996	Goble et al.	7,328,752 B2	2/2008	Gass et al.
5,507,763 A	4/1996	Petersen et al.	7,334,511 B2	2/2008	Hesselberg et al.
D374,286 S	10/1996	Goble et al.	D563,186 S	3/2008	Ahn
D374,287 S	10/1996	Goble et al.	7,344,435 B2	3/2008	Pollak et al.
D374,482 S	10/1996	Goble et al.	7,447,565 B2	11/2008	Cerwin
5,658,304 A	8/1997	Lim	7,478,979 B2	1/2009	Zhou et al.
5,676,680 A	10/1997	Lim	7,481,608 B2	1/2009	Zhou et al.
5,694,693 A	12/1997	Hutchins et al.	7,497,860 B2	3/2009	Carusillo et al.
5,702,415 A	12/1997	Matthai et al.	7,527,628 B2	5/2009	Fletcher et al.
			7,533,470 B2	5/2009	Nottingham et al.
			7,537,065 B2	5/2009	Gallagher et al.
			7,540,334 B2	6/2009	Gass et al.
			7,690,871 B2	4/2010	Steadings et al.

(56)

References Cited

U.S. PATENT DOCUMENTS

7,699,566 B2	4/2010	Nickels, Jr. et al.	D817,127 S *	5/2018	Gopi	D8/20
7,717,191 B2	5/2010	Trautner	D817,128 S *	5/2018	Gopi	D8/20
7,717,192 B2	5/2010	Schroeder et al.	D817,129 S *	5/2018	Gopi	D8/20
7,726,917 B2	6/2010	Mack	10,040,215 B2 *	8/2018	Rubens	B23D 51/10
7,735,575 B2	6/2010	Trautner	D832,666 S *	11/2018	Kaye, Jr.	D8/20
7,746,448 B2	6/2010	Franitza et al.	D853,817 S *	7/2019	Ji	D8/70
D619,152 S	7/2010	Evatt et al.	2001/0041524 A1	11/2001	Steiger et al.	
7,753,381 B2	7/2010	Nickels, Jr. et al.	2002/0070037 A1	6/2002	Jasch	
7,762,349 B2	7/2010	Trautner et al.	2002/0104421 A1	8/2002	Wurst	
7,784,166 B2	8/2010	Tanner	2002/0116023 A1	8/2002	Fletcher et al.	
D623,034 S	9/2010	Evatt et al.	2002/0198556 A1	12/2002	Ark et al.	
7,798,245 B2	9/2010	Trautner	2002/0198556 A1	12/2002	Ark et al.	
7,833,241 B2	11/2010	Gant	2003/0014067 A1	1/2003	Kullmer et al.	
7,841,601 B2	11/2010	Mack	2003/0032971 A1	2/2003	Hausmann et al.	
7,854,274 B2	12/2010	Trautner et al.	2003/0032971 A1	2/2003	Hausmann et al.	
D633,769 S	3/2011	Evatt et al.	2004/0098000 A1	5/2004	Kleinwaechter	
D633,928 S	3/2011	Nilsson et al.	2004/0138668 A1	7/2004	Fisher et al.	
7,901,424 B2	3/2011	Fletcher et al.	2004/0204731 A1	10/2004	Gant	
7,950,152 B2	5/2011	Gallego	2004/0243136 A1	12/2004	Gupta et al.	
7,976,253 B2	7/2011	Steadings et al.	2005/0178261 A1	8/2005	Thomaschewski	
7,987,920 B2	8/2011	Schroeder et al.	2005/0245935 A1	11/2005	Casey et al.	
7,997,586 B2	8/2011	Ziegler et al.	2006/0150428 A1	7/2006	Baculy	
D646,539 S	10/2011	Maras	2006/0172669 A1	8/2006	Hesse et al.	
D646,540 S	10/2011	Maras	2006/0217048 A1	9/2006	Frech et al.	
D646,542 S	10/2011	Wackwitz	2006/0217048 A1	9/2006	Frech et al.	
8,038,156 B2	10/2011	Nickels, Jr. et al.	2006/0272468 A1	12/2006	Gupta et al.	
D648,762 S	11/2011	Mack	2006/0282108 A1	12/2006	Tanner	
8,047,100 B2	11/2011	King	2007/0060030 A1	3/2007	Pollak et al.	
D651,062 S	12/2011	Wackwitz	2007/0093190 A1	4/2007	Schomisch	
8,070,168 B2	12/2011	Mack	2007/0229853 A1	10/2007	Cheng	
8,082,671 B2	12/2011	Saegesser	2007/0266837 A1	11/2007	Nickels et al.	
D651,499 S	1/2012	Tong	2007/0295156 A1	12/2007	Ziegler et al.	
D651,874 S	1/2012	Davidian et al.	2007/0295165 A1	12/2007	Tanaka et al.	
D651,875 S	1/2012	Davidian et al.	2008/0027449 A1	1/2008	Gundlapalli et al.	
D651,876 S	1/2012	Davidian et al.	2008/0190259 A1	8/2008	Bohne	
D651,877 S	1/2012	Davidian et al.	2008/0196911 A1	8/2008	Krapf et al.	
D651,878 S	1/2012	Davidian et al.	2009/0013540 A1	1/2009	Bohne	
D652,274 S	1/2012	Davidian et al.	2009/0023371 A1	1/2009	Blickle et al.	
D653,523 S	2/2012	Wackwitz et al.	2009/0051094 A1	2/2009	Sandmeier	
8,109,343 B2	2/2012	Schroeder et al.	2009/0093815 A1	4/2009	Fletcher et al.	
8,113,520 B2	2/2012	Zaiser et al.	2009/0138017 A1	5/2009	Carusillo et al.	
8,151,679 B2	4/2012	Bohne	2009/0197514 A1	8/2009	Peisert	
D665,242 S	8/2012	Wackwitz	2009/0198465 A1	8/2009	Decker et al.	
D682,651 S	5/2013	McRoberts et al.	2009/0277022 A1	11/2009	Limberg et al.	
D682,652 S	5/2013	McRoberts et al.	2009/0312761 A1	12/2009	Boykin et al.	
D693,193 S	11/2013	Bozic	2009/0312762 A1	12/2009	Boykin	
D694,076 S *	11/2013	Davidian	2009/0312779 A1	12/2009	Boykin et al.	
D694,077 S	11/2013	Bozic	2009/0318065 A1	12/2009	Zaiser et al.	
D694,596 S	12/2013	Davidian et al.	2009/0320625 A1	12/2009	Kildevaeld	
D694,597 S	12/2013	Davidian et al.	2009/0321625 A1	12/2009	Sieradzki et al.	
D694,598 S	12/2013	Davidian et al.	2010/0003906 A1	1/2010	Zaiser et al.	
D697,384 S *	1/2014	Wackwitz	2010/0009613 A1	1/2010	Frueh	
D706,595 S	6/2014	Kaye et al.	2010/0052269 A1	3/2010	Zaiser et al.	
8,915,499 B2	12/2014	Kaye et al.	2010/0056029 A1	3/2010	Grunikiewicz	
8,925,931 B2	1/2015	Sergyenko et al.	2010/0193207 A1	8/2010	Mok et al.	
8,936,597 B2 *	1/2015	Wang	2010/0197208 A1	8/2010	Blickle et al.	
			2010/0288099 A1	11/2010	Steiger	
			2010/0300714 A1	12/2010	Trautner	
			2011/0000690 A1	1/2011	Kildevaeld	
			2011/0011605 A1	1/2011	Kildevaeld	
			2011/0067894 A1	3/2011	Bernardi	
			2011/0072946 A1	3/2011	Bernardi et al.	
			2011/0086582 A1	4/2011	Takemura et al.	
			2011/0097978 A1	4/2011	Hofmann et al.	
			2011/0127731 A1	6/2011	Woecht et al.	
			2011/0139472 A1	6/2011	Bohne	
			2011/0147023 A1	6/2011	Herr	
			2011/0227300 A1	9/2011	Zhang et al.	
			2011/0266757 A1	11/2011	Steadings et al.	
			2011/0266758 A1	11/2011	Sergyenko et al.	
			2011/0266759 A1	11/2011	Goldman	
			2011/0316241 A1	11/2011	Zhang et al.	
			2011/0291368 A1	12/2011	Chen et al.	
			2011/0309589 A1	12/2011	Maras	
			2011/0315414 A1	12/2011	Kuntner et al.	
			2011/0316242 A1	12/2011	Zhang et al.	
			2012/0025476 A1	2/2012	Nickels, Jr. et al.	
			2012/0031636 A1	2/2012	King	
			2012/0073410 A1	3/2012	Hoffman et al.	
			2012/0090863 A1	4/2012	Puzio et al.	
			2012/0144971 A1	6/2012	Bohne	
			2012/0169018 A1	7/2012	Lu et al.	
D724,923 S *	3/2015	McRoberts				
9,067,293 B2	6/2015	Bernardi et al.				
D734,649 S	7/2015	Wackwitz				
9,073,195 B2	7/2015	Kaye, Jr. et al.				
D741,135 S *	10/2015	Yang				D15/140
D741,136 S *	10/2015	Yang				D15/140
D741,137 S *	10/2015	Yang				D8/70
9,186,770 B2	11/2015	Montplaisir et al.				
D746,655 S	1/2016	Wackwitz				
9,242,361 B2	1/2016	Kaye, Jr. et al.				
D750,461 S *	3/2016	McRoberts				D8/70
9,346,183 B2	5/2016	Fanhauser et al.				
9,486,887 B2	11/2016	Fankhauser et al.				
D789,759 S	6/2017	Fellmann et al.				
9,815,187 B2 *	11/2017	Kozak				B25F 3/00
D807,719 S *	1/2018	Gopi				D8/20
D813,624 S *	3/2018	Gopi				D8/20
D814,900 S	4/2018	Kaye, Jr. et al.				

(56)

References Cited

U.S. PATENT DOCUMENTS

2013/0104719 A1 5/2013 Rubens et al.
 2013/0193655 A1 8/2013 Kaye et al.
 2014/0015207 A1* 1/2014 Kaye, Jr. B25F 3/00
 279/143
 2014/0035242 A1 2/2014 Kaye et al.
 2014/0182873 A1 7/2014 Fankhauser et al.
 2014/0252729 A1 9/2014 Xu
 2014/0299345 A1 10/2014 McRoberts et al.
 2014/0325855 A1 11/2014 Bozic
 2014/0345148 A1* 11/2014 Kaye, Jr. B26D 1/0006
 30/356
 2015/0266102 A1* 9/2015 Kozak B25F 3/00
 279/143
 2016/0184956 A1 6/2016 Klabunde et al.
 2016/0199919 A1 7/2016 Klabunde et al.
 2016/0288288 A1 10/2016 Klabunde et al.
 2017/0129126 A1* 5/2017 Rubens B23D 51/10
 2017/0182570 A1* 6/2017 Dvorak B23D 51/00
 2017/0291238 A1* 10/2017 Bernardi B23D 61/006
 2018/0029190 A1* 2/2018 Nagy B24B 23/04
 2018/0117687 A1* 5/2018 Rubens B23D 51/10

FOREIGN PATENT DOCUMENTS

CN 201728642 2/2011
 CN 201824333 A1 5/2011
 DE 1878647 U 8/1963
 DE 2915292 A1 10/1980
 DE 2935731 A1 4/1981
 DE 3203670 A1 8/1983
 DE 3520417 12/1985
 DE 3833735 A1 4/1989
 DE 8618695 U1 9/1989
 DE 4036904 C1 5/1992
 DE 4209146 A1 9/1992
 DE 4209146 A1 9/1992
 DE 29605728 U1 9/1996
 DE 29607061 U1 10/1996
 DE 29810157 U1 8/1998
 DE 19736933 C1 10/1998
 DE 29907671 U1 8/1999
 DE 29809788 U1 9/1999
 DE 19825408 A1 12/1999
 DE 20303018 U1 4/2003
 DE 10231393 1/2004
 DE 10307840 B3 6/2004
 DE 10325392 A1 12/2004
 DE 102004020982 A1 11/2005
 DE 202006001643 U1 3/2006
 DE 102004050799 A1 4/2006
 DE 102007018465 A1 10/2008
 DE 102007018467 A1 10/2008
 DE 202009004549 U1 6/2009
 DE 202008001759 U1 7/2009
 DE 102008001234 A1 10/2009
 DE 202009013147 U1 1/2010
 DE 202008011959 U1 2/2010
 DE 102009030854 A1 1/2011
 DE 202011050164 U1 10/2011
 DE 202011050511 U1 11/2011
 DE 202011051408 U1 2/2012
 DE 202011051408 U1 2/2012
 DE 102011005818 A1 9/2012
 DE 102011085561 A1 12/2012
 DE 102012201624 A1 8/2013
 EP 0443362 A2 8/1991
 EP 0554929 A1 8/1993
 EP 0695607 A1 2/1996
 EP 0776634 A2 6/1997
 EP 0962283 A1 12/1999
 EP 1694477 A1 6/2005
 EP 1687120 A1 8/2006

EP 1819490 A1 8/2007
 EP 1852218 A1 11/2007
 EP 1882538 A2 1/2008
 EP 2085182 A1 8/2009
 EP 2143531 A1 1/2010
 EP 2152475 A1 2/2010
 EP 2159000 A1 3/2010
 EP 2382929 A1 11/2011
 JP 1158205 A 6/1989
 JP 2006263914 A 10/2006
 WO WO-9424945 A1 11/1994
 WO WO-03097299 A1 11/2003
 WO WO-2004043269 A1 5/2004
 WO WO-2005056256 A1 6/2005
 WO WO-2006017066 A2 2/2006
 WO WO-2008151866 A1 12/2008
 WO WO-2009151958 A2 12/2009
 WO WO-2009151959 A1 12/2009
 WO WO-2009151965 A1 12/2009
 WO WO-2010020458 A1 2/2010
 WO WO-2013067960 A1 5/2013

OTHER PUBLICATIONS

Materials from Stryker Corporation Brochure published prior to Jan. 1, 1994.
 Aloe Medical Instruments “Gall Ball Retractor” Item B-1323, p. 115 © 1965.
 Stryker Maintenance Manual entitled “System II OrthoPower 90 Battery Powered Surgical Instruments”—For Use With: 298-92, 94,96, 98 (Stryker Surgical Brochure 298-92-16 Rev (Mar. 1986). Sketch A related to p. 9 of the Stryker Maintenance Manual entitled “System II OrthoPower 90 Battery Powered Surgical Instruments” (Mar. 1986).
 Stryker prior art brochure/-catalog No. 1420 Standard Bone Saw Handpiece, 1100 Series saw blades, and No. 1470 Sagittal Plane bone saw with Series 1370 blades. pp. 2, 3 and 5.
 Hall Surgical brochure—New Opposed-Tooth Blades—published prior to Jan. 1, 1994.
 Dremel 6300-05 120-volt Multi-Max Oscillating Kit (retrieved on Sep. 30, 2014) viewed on the internet. <https://web.archive.org/web/20091224220316/http://www.amazon.com/Dremel-6300-05-120-Volt-Multi-Max-Oscillating/dp/B002WTCDXO> published on Dec. 24, 2009 as per Wayback Machine.
 O’Connell, Wayne—Patent Examination Report No. 3 re Australian Patent Application No. 2011201633—Oct. 2, 2014—6 pages—Woden ACT, Canberra, Australia.
 Dewaele, Karl—Examination Report re: European Patent Appln. No. 15160839.5-1701—Nov. 9, 2016—6 pages.
 Kornmeier, Martin—Extended European Search Report re European Patent Appln. No. 13163355.4—Nov. 27, 2017—5 pages—Munich.
 Kornmeier, Martin—Search Report re European Patent Application No. 18200787.2-1016—Feb. 14, 2019—4 pages—Munich.
 Kornmeier, Martin—Search Report re European Patent Application Application No. 18200668.4-1016—Feb. 14, 2019—4 pages—Munich.
 Kornmeier, Martin—Communication Pursuant to Article 94(3) EPC re European Patent Application No. 18200787.2-1016—Mar. 13, 2019—6 pages—Munich.
 Kornmeier, Martin—Communication Pursuant to Article 94(3) EPC re European Patent Application No. 18200791.4-1016—Mar. 13, 2019—6 pages—Munich.
 Kornmeier, Martin—Communication Pursuant to Article 94(3) EPC re European Patent Application No. 18200668.4-1016—Mar. 13, 2019—6 pages—Munich.
 Zimmer, Inc., Brochure “More Versatile ‘Graft’ Blades Available” dated Feb. 15, 1993, 2 pages; © 1993 Zimmer, Inc.
 Dewaele, Karl—European Search Report—dated Jun. 20, 2014 —7 pages—The Hague.

* cited by examiner

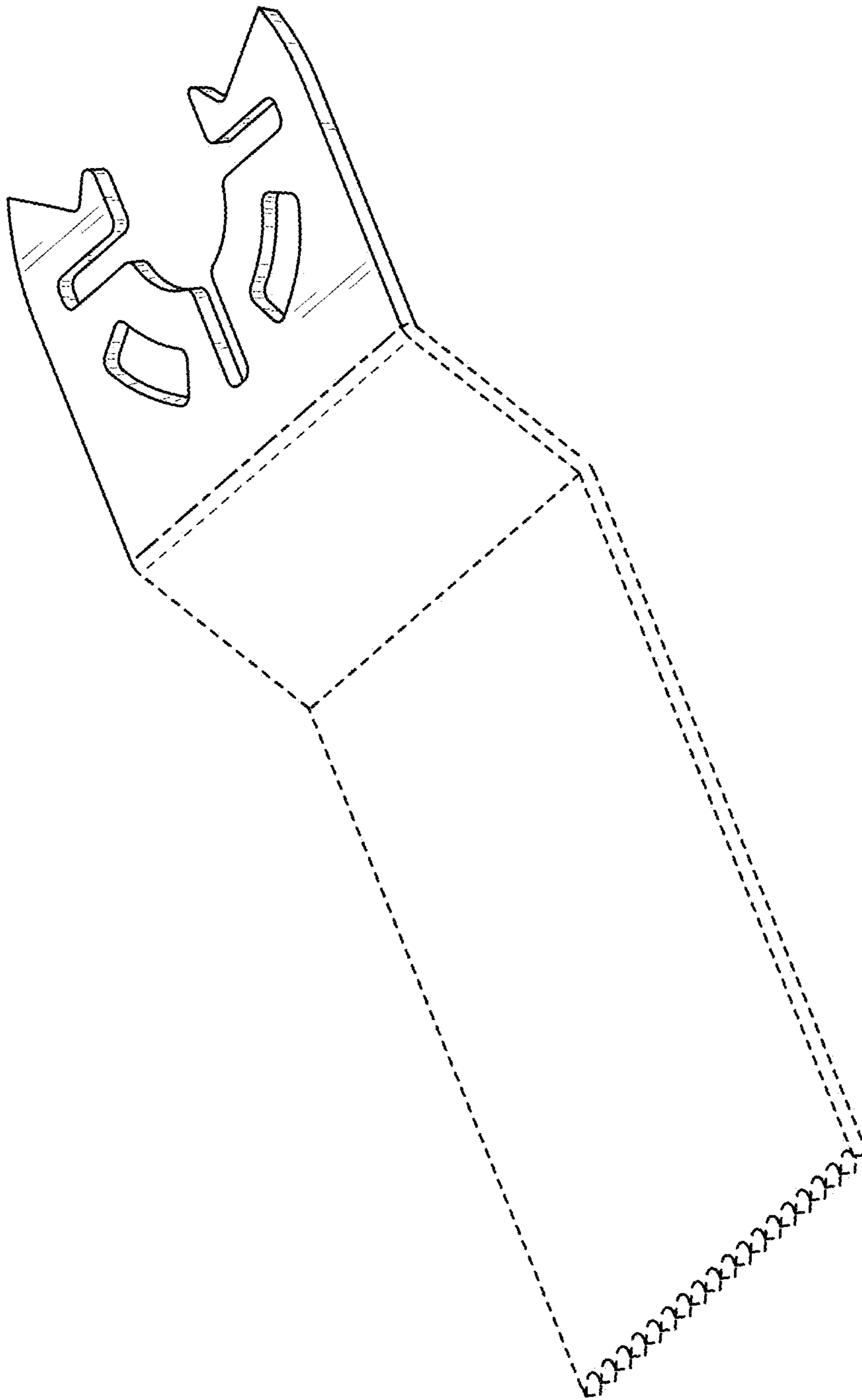

FIG. 1

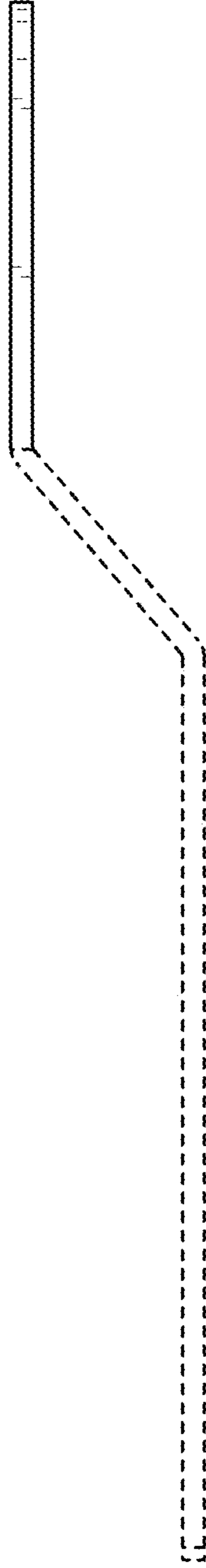

FIG. 2

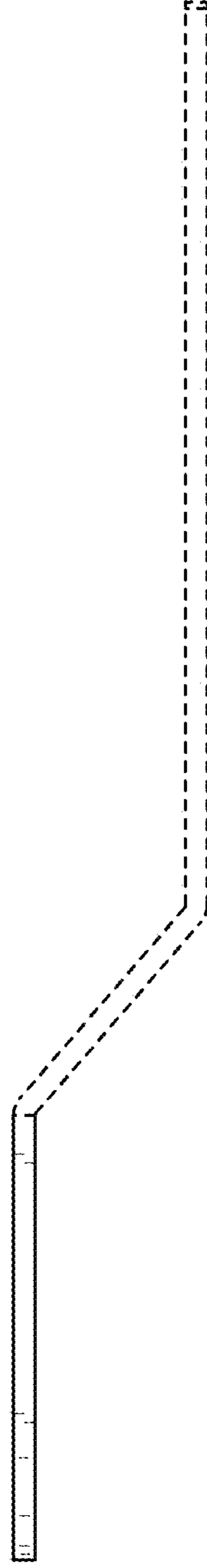

FIG. 3

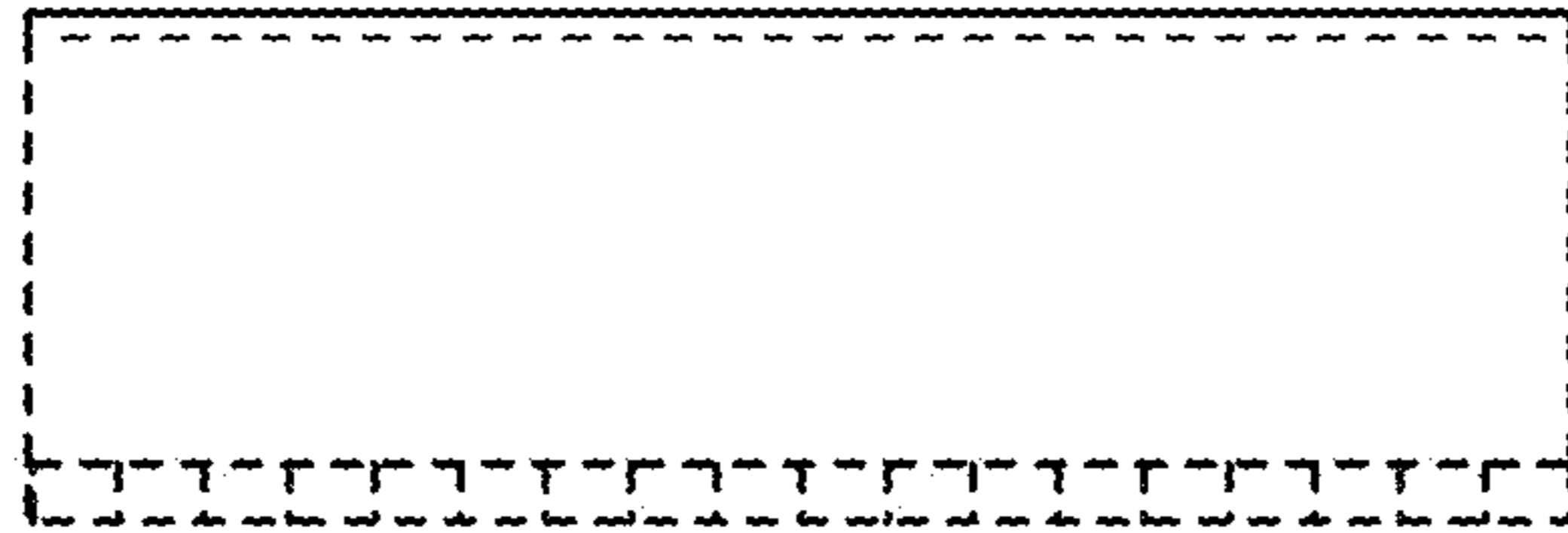

FIG. 4

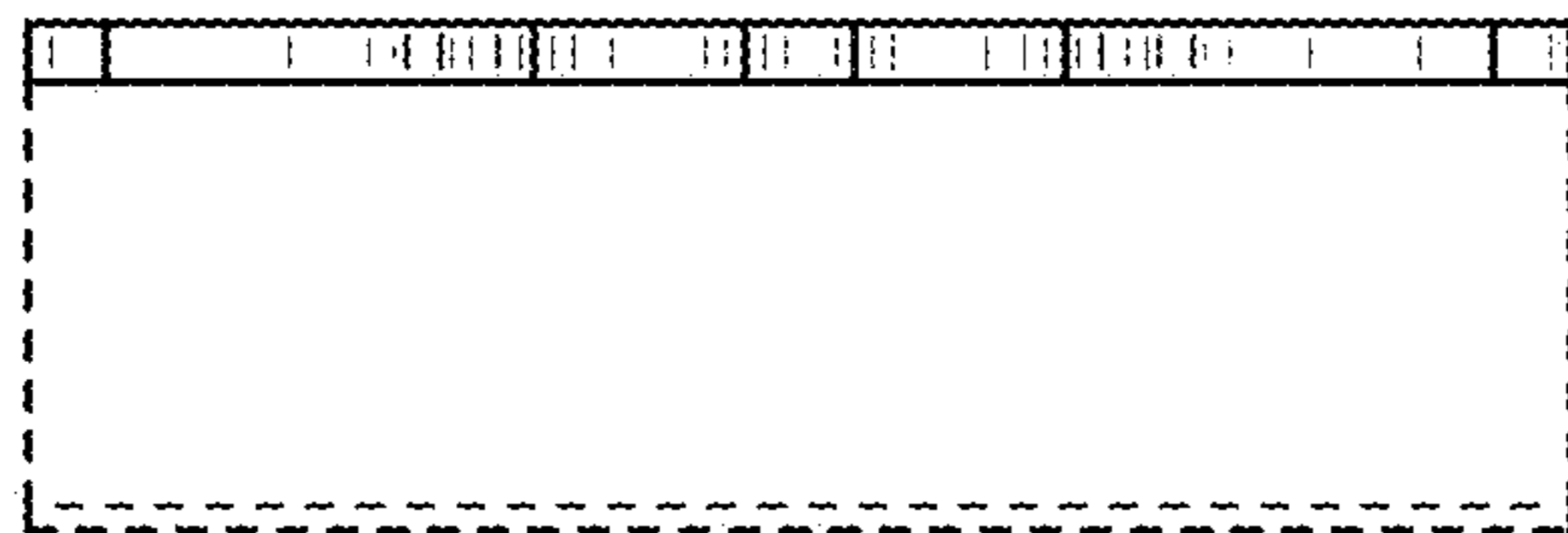

FIG. 5

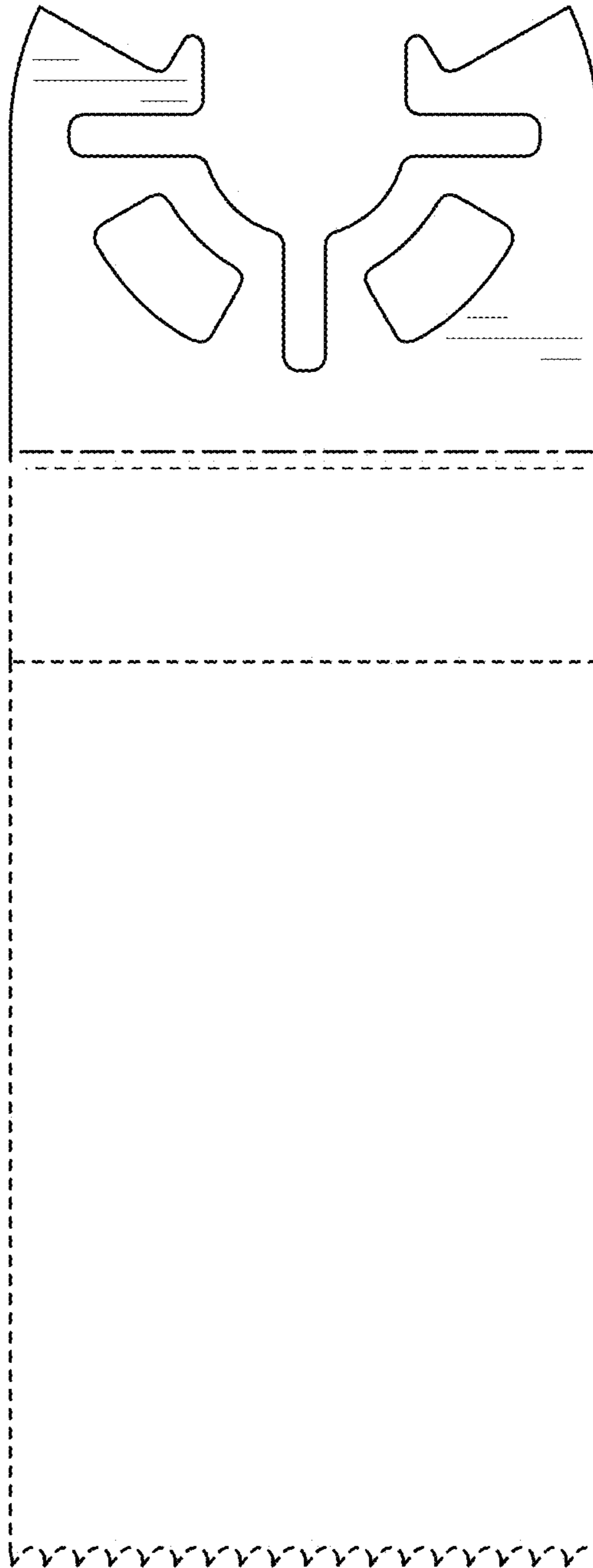

FIG. 6

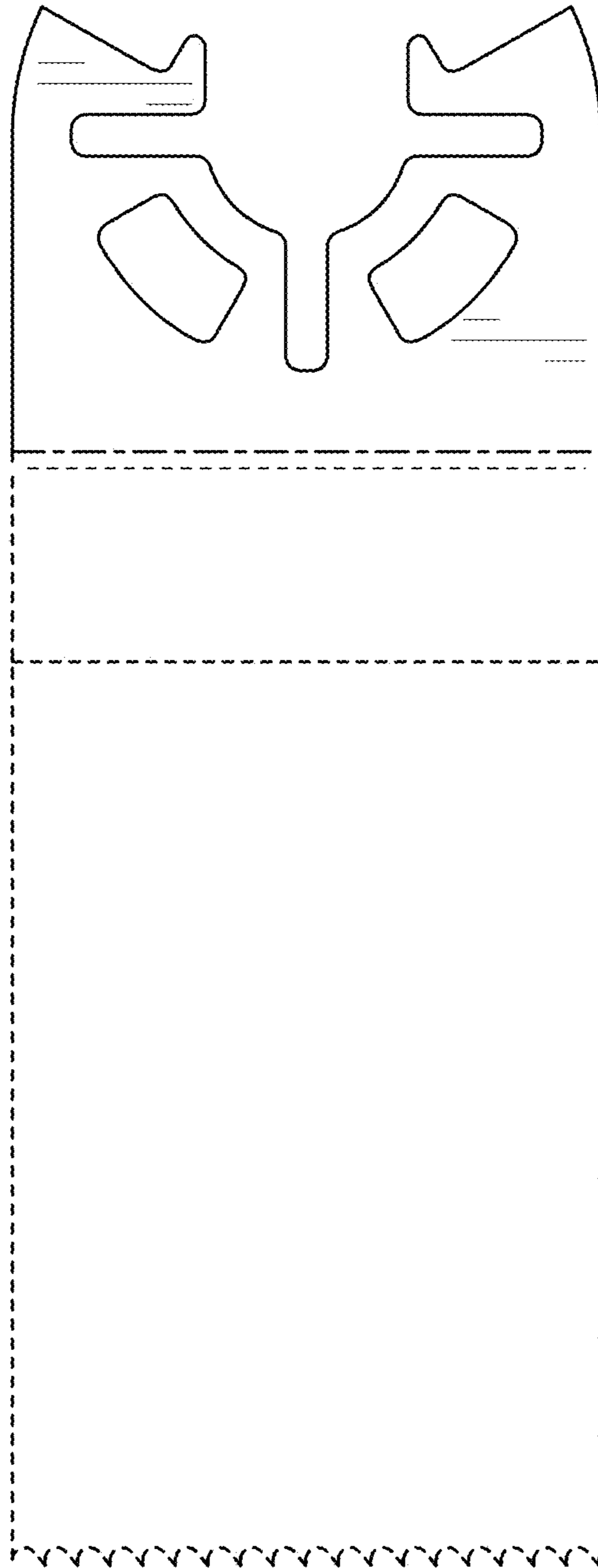

FIG. 7