



US00D884438S

(12) **United States Design Patent** (10) **Patent No.:** **US D884,438 S**  
**Rose** (45) **Date of Patent:** **\*\* May 19, 2020**

(54) **FINGER TONGS**

(71) Applicant: **Allison Rose**, Colorado Springs, CO (US)

(72) Inventor: **Allison Rose**, Colorado Springs, CO (US)

(\*\*) Term: **15 Years**

(21) Appl. No.: **29/596,581**

(22) Filed: **Mar. 9, 2017**

(51) **LOC (12) Cl.** ..... **07-03**

(52) **U.S. Cl.**  
USPC ..... **D7/648**

(58) **Field of Classification Search**

USPC ..... D7/642–654, 662, 664, 666, 669, 672, D7/673, 676, 681–683, 687, 688, D7/691–697, 401, 401.1, 401.2, 368, 393, D7/394, 395, 505, 660, 661, 675, 689, D7/690; D19/45, 46, 47, 48, 49, 36, 41, D19/50, 55, 59, 139; D21/440, 568; D22/117, 118, 119, 120; D8/95, 96, 97, D8/98, 99; 30/137, 141, 142, 143, 147, 30/148, 149, 150, 151, 152, 153, 154, 30/160, 328, 329, 294, 295, 322, 323, 30/324, 325, 326, 327; 34/240; 220/574.1, 735; 294/3, 16, 58, 99.2, 218, 294/1.1, 5.5, 11, 33, 99.1, 100, 106, 119, 294/8.5, 25, 99 R, 99 S; 401/52, 6, 57, 401/96; 416/70 R, 75  
CPC ..... A47G 21/02; A47G 21/06; A47G 21/08; A47G 21/04; A47G 21/103; A47G 21/00;

(Continued)

(56) **References Cited**

**U.S. PATENT DOCUMENTS**

D254,466 S \* 3/1980 Carson ..... 100/116  
4,261,608 A \* 4/1981 Bradshaw ..... A47G 21/08  
294/25  
D260,222 S \* 8/1981 Conti ..... D7/666

(Continued)

**OTHER PUBLICATIONS**

“24 X Bamboo Catering Tongs 10cm Disposable Finger Food Cocktail BBQ,” available Mar. 14, 2018, [online], [site visited Mar. 14, 2018]. Available from Internet, URL:https://www.ebay.com.au/p/24-X-Bamboo-Catering-Tongs-10cm-Disposable-Finger-Food-Cocktail-BBQ/1577838998 (Year: 2018).\*

(Continued)

*Primary Examiner* — Michael C Stout

*Assistant Examiner* — Katrina N Gonzalez

(74) *Attorney, Agent, or Firm* — Hanes & Bartels LLC

(57) **CLAIM**

The ornamental design for the finger tongs, as shown and described.

**DESCRIPTION**

FIG. 1 is a perspective view of the finger tongs, shown in a folded configuration.

FIG. 2 is another perspective view, shown in a folded configuration.

FIG. 3 is a top perspective view thereof, shown in an unfolded configuration.

FIG. 4 is a top view thereof;

FIG. 5 is a right side view thereof;

FIG. 6 is a bottom view thereof;

FIG. 7 is a left side view thereof;

FIG. 8 is an enlarged first end view thereof;

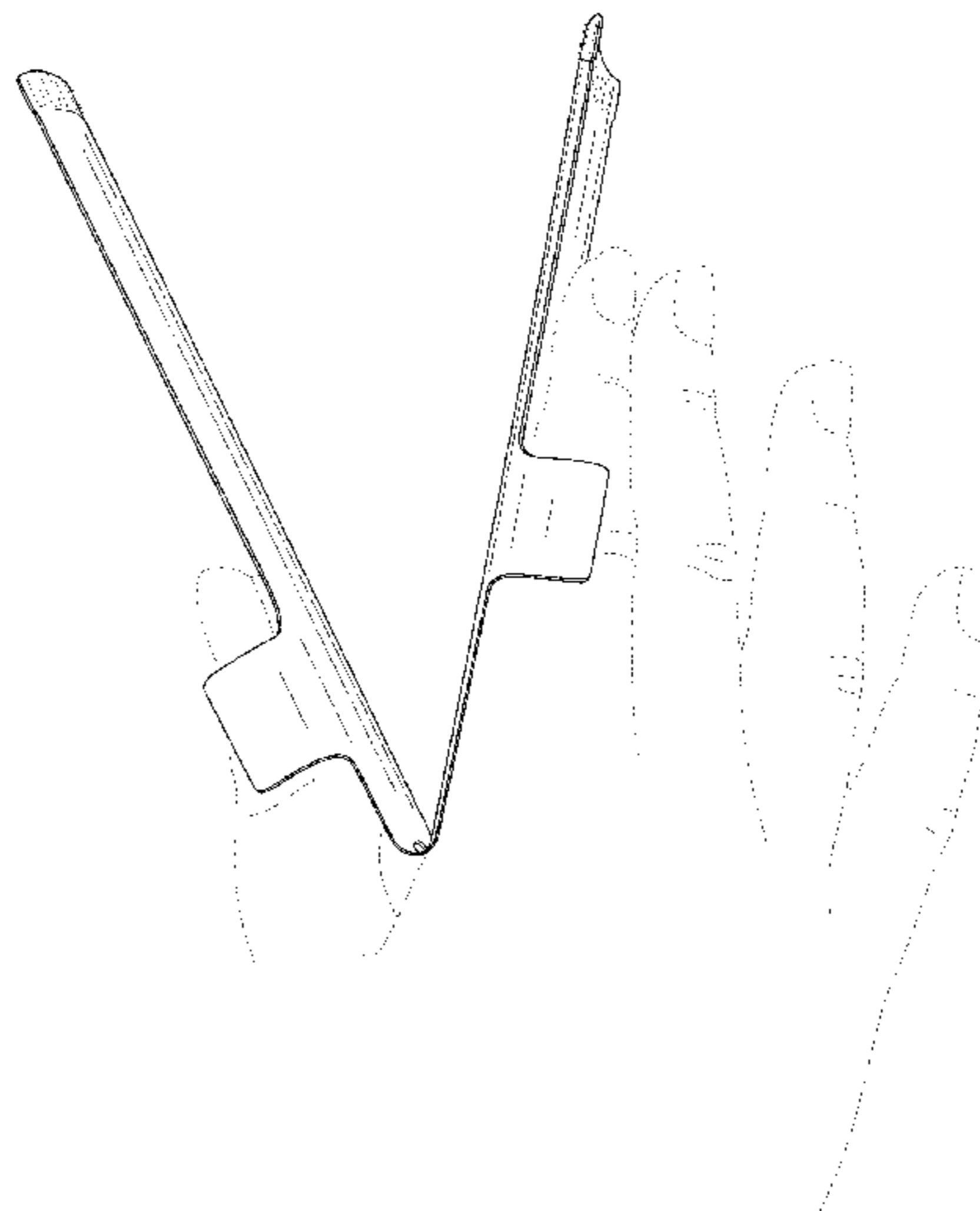
FIG. 9 is an enlarged second end view thereof;

FIG. 10 is a right side view thereof, shown in a folded configuration; and,

FIG. 11 is a top plan view thereof.

The broken lines showing the hand in FIG. 1 illustrate environmental structure that form no part of the claimed design. The broken lines in FIGS. 1 through 11 illustrate portions of the finger tongs that form no part of the claimed design.

**1 Claim, 5 Drawing Sheets**



- (58) **Field of Classification Search**  
 CPC ..... A47G 21/10; B26B 11/00; B26B 29/025;  
 A47J 2043/04409; A47J 43/283  
 See application file for complete search history.

D805,720	S	*	12/2017	Rubio Lamas	.....	D1/122
D805,721	S	*	12/2017	Rubio Lamas	.....	D1/122
D805,722	S	*	12/2017	Rubio Lamas	.....	D1/122
D805,723	S	*	12/2017	Rubio Lamas	.....	D1/122
D805,724	S	*	12/2017	Rubio Lamas	.....	D1/122
2014/0367988	A1	*	12/2014	Woo	.....	A47G 21/103 294/218

- (56) **References Cited**

U.S. PATENT DOCUMENTS

D279,852	S	*	7/1985	Yokoyama	.....	294/99.2
D284,440	S	*	7/1986	Zieff	.....	D7/666
D291,169	S	*	8/1987	Foulds	.....	D7/666
4,826,227	A	*	5/1989	Lew	.....	A47G 21/103 294/16
D311,851	S	*	11/1990	Allardyce	.....	D7/642
D404,130	S	*	1/1999	Stefano	.....	D24/147
D404,922	S	*	2/1999	Mølster	.....	D24/146
D406,341	S	*	3/1999	Stefano	.....	D24/147
D412,986	S	*	8/1999	Abraham	.....	D24/146
D435,201	S	*	12/2000	Wang	.....	D7/642
D463,220	S	*	9/2002	Yun	.....	D7/642
D545,635	S	*	7/2007	Dorfman	.....	D7/642
D578,834	S	*	10/2008	Do	.....	D7/637
D601,389	S	*	10/2009	Brown	.....	D7/642
7,845,081	B1	*	12/2010	Shultz	.....	A47J 25/00 30/113.1
D657,636	S	*	4/2012	Carr	.....	D7/642
D683,597	S	*	6/2013	Dixon	.....	D7/642
D705,613	S	*	5/2014	Dixon	.....	D7/642
D728,319	S	*	5/2015	Dixon	.....	D7/642
D752,926	S	*	4/2016	Toth, III	.....	D7/642
D767,347	S	*	9/2016	Takabu	.....	D7/642
D784,096	S	*	4/2017	Jones	.....	D7/684
D801,128	S	*	10/2017	Palmby	.....	D7/642

OTHER PUBLICATIONS

“3.9 Mini Bamboo Disposable Tongs,” available Mar. 29, 2017, [online], [site visited Mar. 14, 2018]. Available from Internet, URL: <https://www.bamboomn.com/3-9-Mini-Bamboo-Disposable-Tongs-p/tnut-039.htm> (Year: 2017).\*

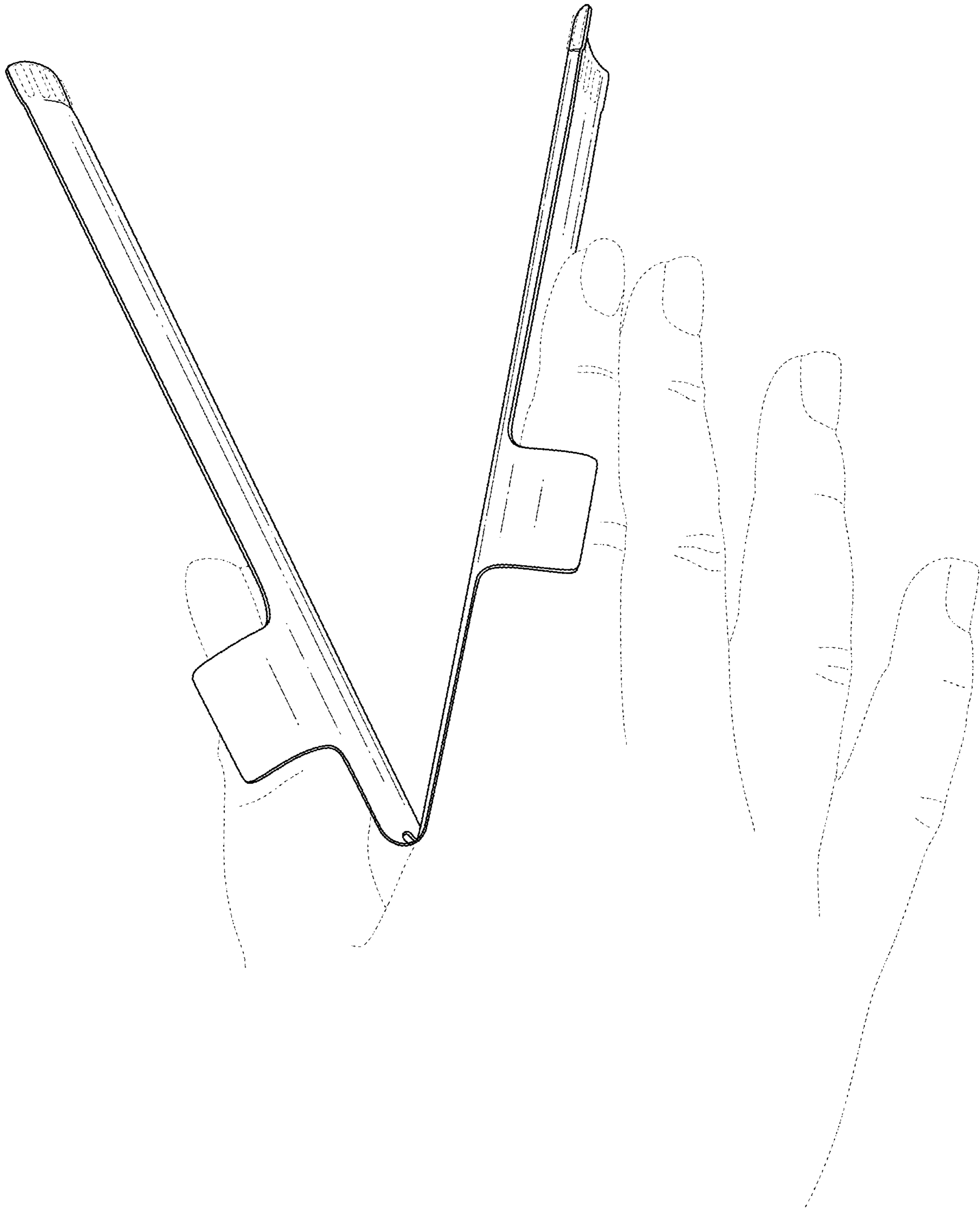
“Tiny Plastic Tongs,” available Mar. 14, 2018, [online], [site visited Mar. 14, 2018]. Available from Internet, URL: <https://www.partytrends.ca/tiny-tongs-45/> (Year: 2018).\*

“Jonathan’s Wild Cherry Natural Wood 10\_ Folding Tongs,” available Mar. 14, 2018, [online], [site visited Mar. 14, 2018]. Available from Internet, URL: <https://www.ceramcor.com/jonathan-wild-cherry-natural-wood-folding-tong/> (Year: 2018).\*

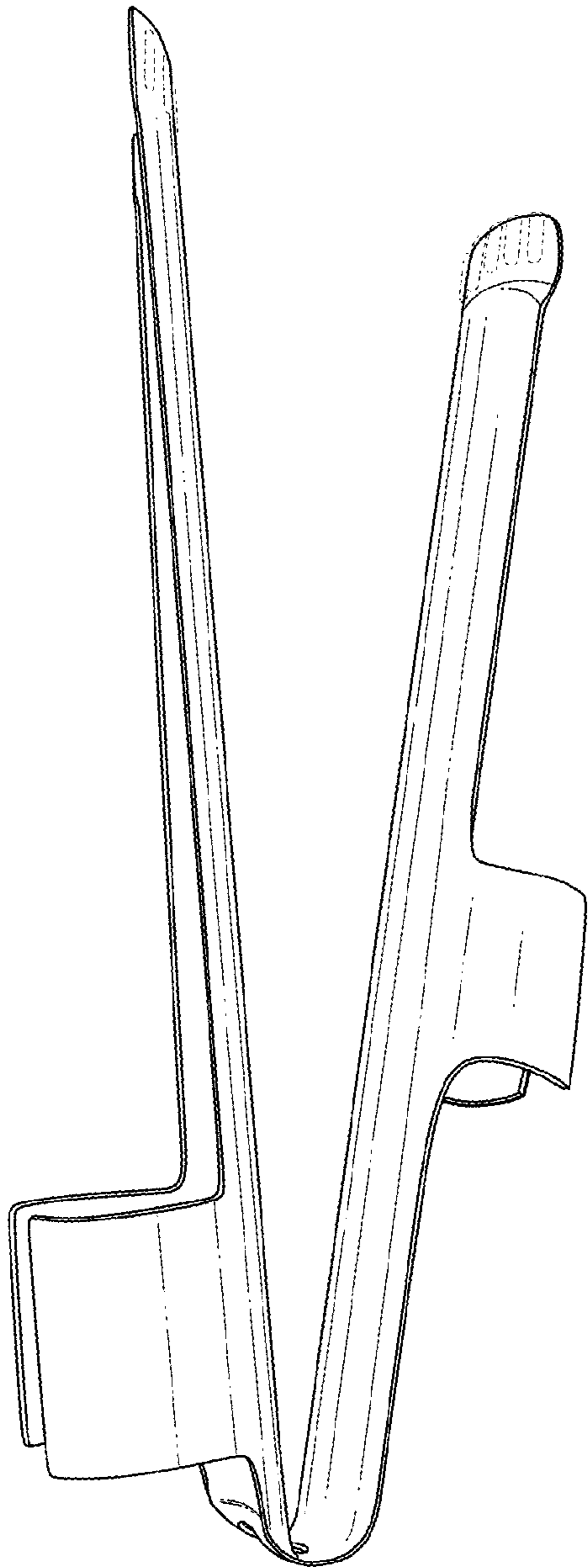
“Finger Tubular Gauze Bandage With Applicator 1,” available Mar. 14, 2018, [online], [site visited Mar. 14, 2018]. Available from Internet, URL: <https://www.ebay.co.uk/itm/FINGER-TUBULAR-GAUZE-BANDAGE-WITH-APPLICATOR-1-6CM-X-4M-/150568985543> (Year: 2018).\*

Metal Tubular Bandage Applicator Finger Tong \_ eBay“,” available Mar. 7, 2018, [online], [site visited Mar. 14, 2018]. Available from Internet, URL: <https://www.ebay.co.uk/itm/Metal-Tubular-Bandage-Applicator-Finger-Tong-/173164153677> (Year: 2018).\*

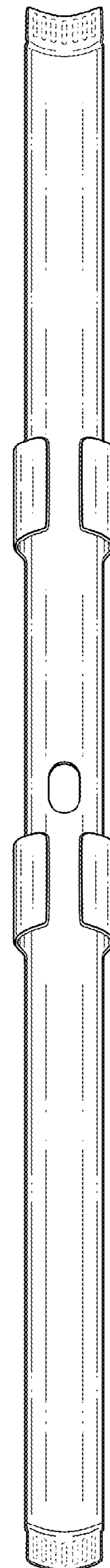
\* cited by examiner



**Fig. 1**

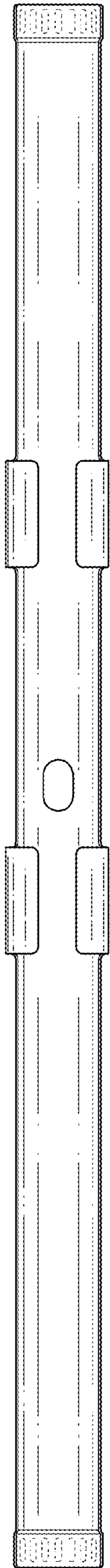


**Fig. 2**



**Fig. 3**

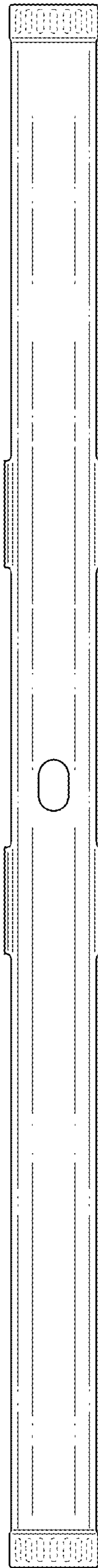




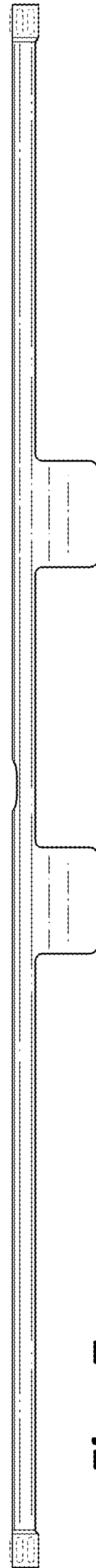
**Fig. 4**



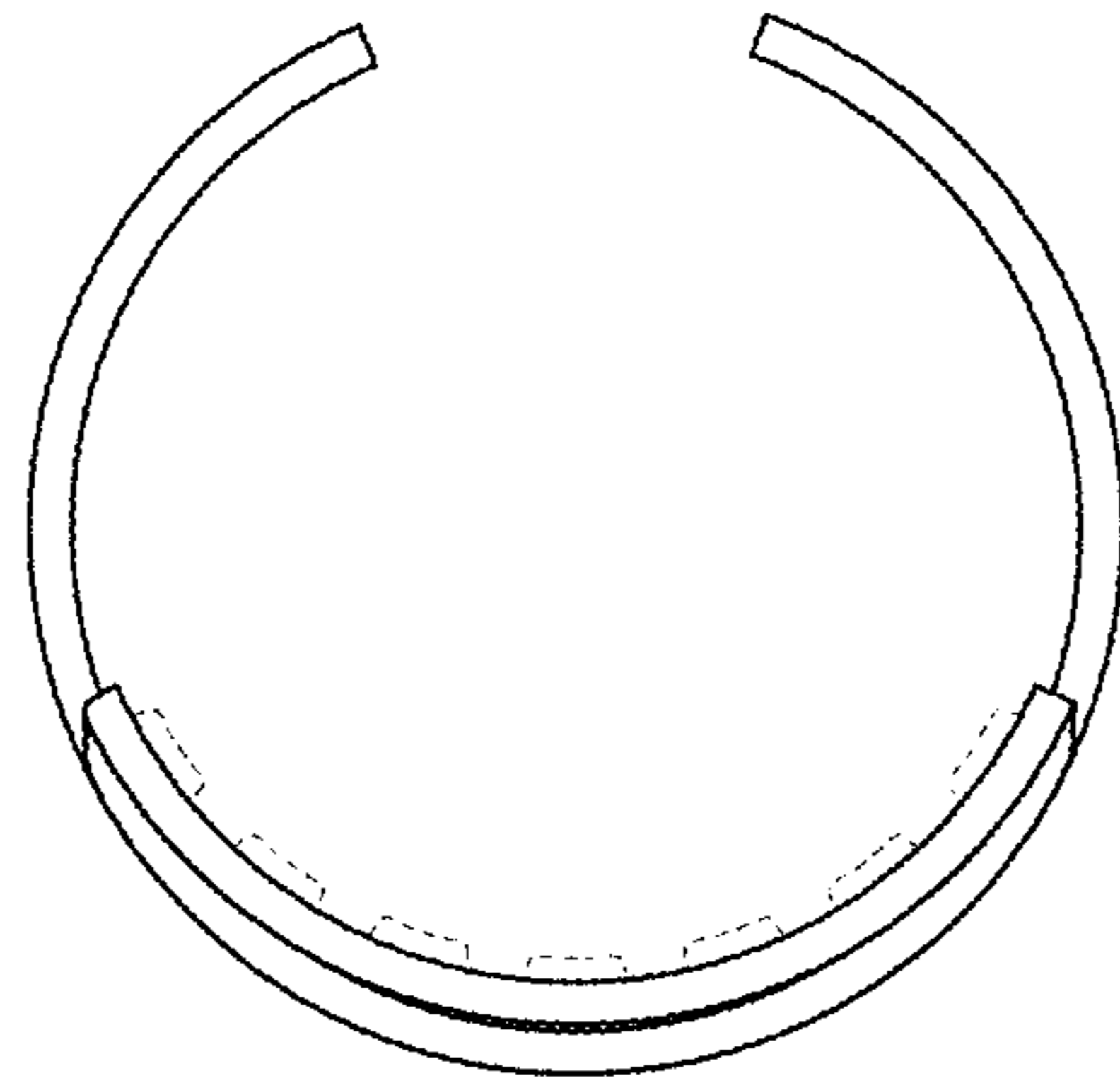
**Fig. 5**



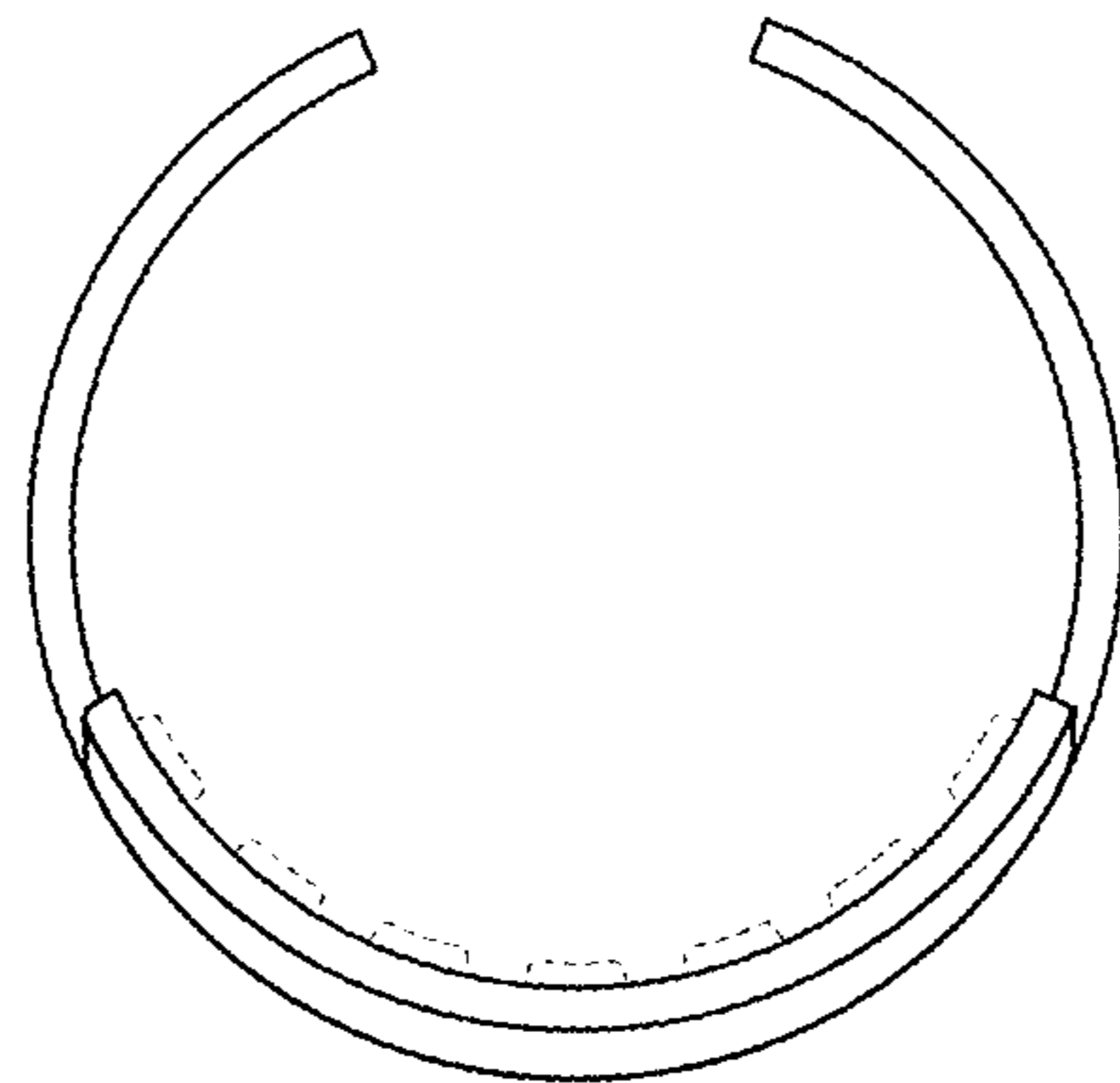
**Fig. 6**



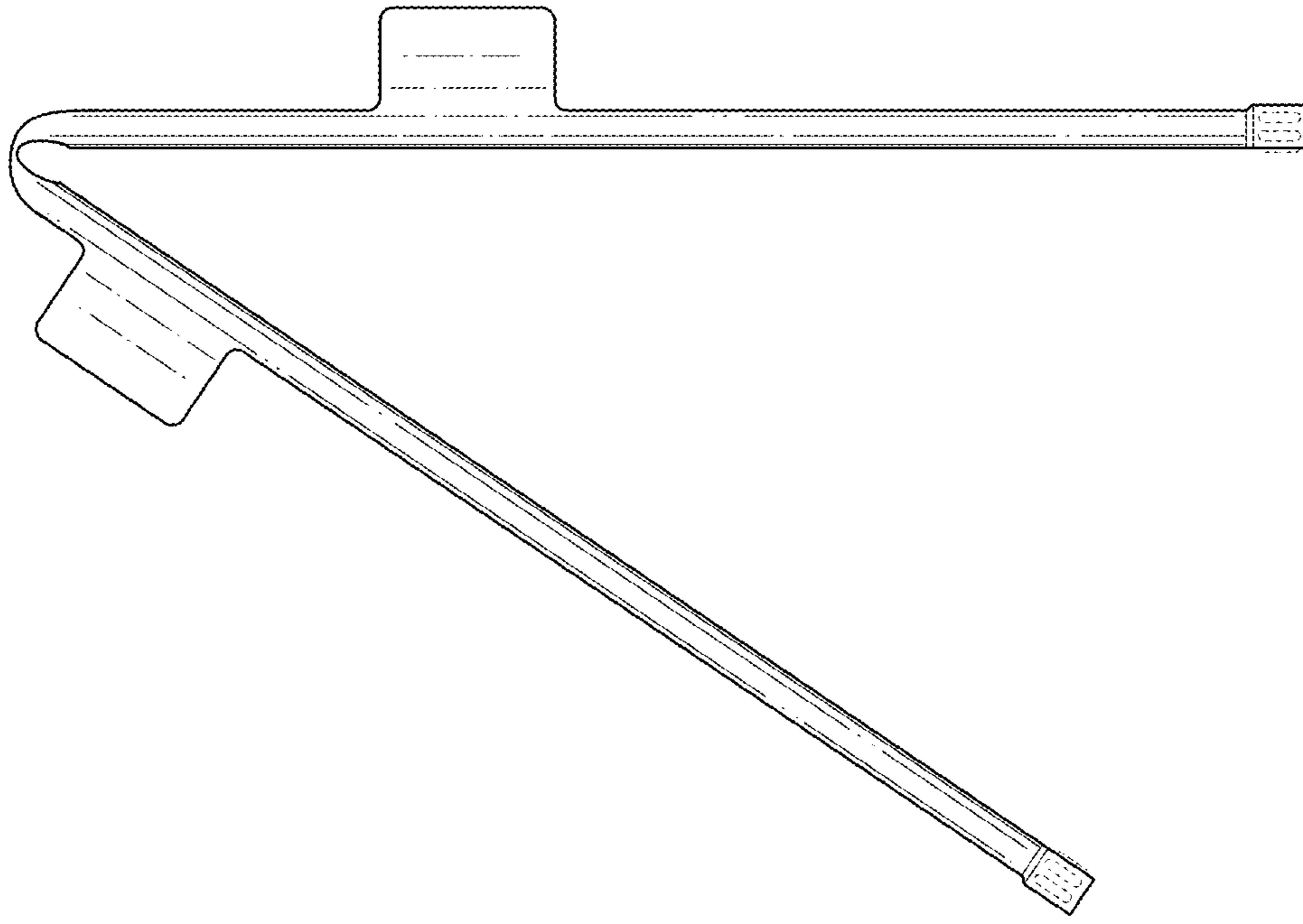
**Fig. 7**



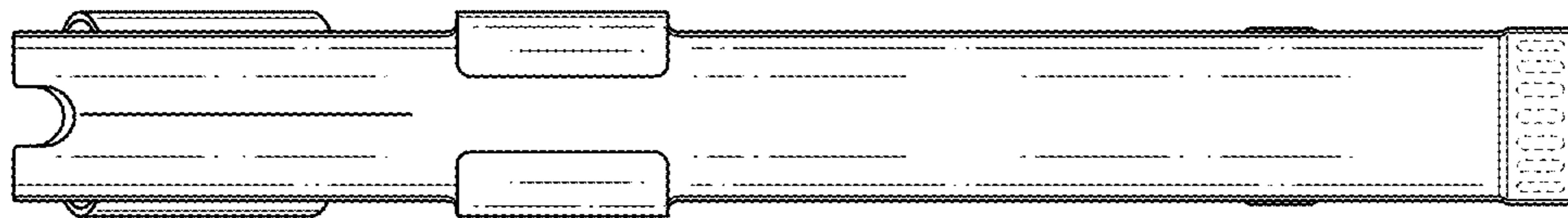
**Fig. 9**



**Fig. 8**



**Fig. 10**



**Fig. 11**