



US00D884399S

(12) **United States Design Patent**
Tan

(10) **Patent No.:** **US D884,399 S**

(45) **Date of Patent:** **** May 19, 2020**

(54) **CENTER FOLDING TABLE**

(71) Applicant: **Zhuhai Shichang Metals Ltd.**, Zhuhai (CN)

(72) Inventor: **Guogong Tan**, Guangdong (CN)

(73) Assignee: **Zhuhai Shichang Metals Ltd.**, Zhuhai (CN)

(**) Term: **15 Years**

(21) Appl. No.: **29/661,463**

(22) Filed: **Aug. 28, 2018**

(51) **LOC (12) Cl.** **06-03**

(52) **U.S. Cl.**
USPC **D6/686**

(58) **Field of Classification Search**

USPC D6/685, 686, 691, 691.1-691.9
CPC .. A47B 3/00; A47B 3/002; A47B 3/02; A47B 3/08; A47B 3/0812; A47B 3/0818; A47B 3/083; A47B 3/0912; A47B 2003/006; A47B 2003/008; A47B 2003/025; A47B 2003/0821; A47B 7/00; A47B 13/00; A47B 13/02; A47B 13/04; A47B 13/06; A47B 13/08; A47B 21/00; A47B 2200/0001; A47B 2200/0011; A47B 2200/002; A47B 2200/0035; A47B 2200/005

See application file for complete search history.

(56) **References Cited**

U.S. PATENT DOCUMENTS

4,927,128 A * 5/1990 O'Brian A47B 3/087
108/36
D437,145 S * 2/2001 Leng A47B 3/083
D6/691.6

(Continued)

Primary Examiner — Mary Ann Calabrese

(74) *Attorney, Agent, or Firm* — Luedeka Neely Group, P.C.

(57) **CLAIM**

The ornamental design for a center folding table, as shown and described.

DESCRIPTION

FIG. 1 is a top perspective view of the center folding table in an unfolded position according to my new design; FIG. 2 is a bottom perspective view of the center folding table in an unfolded position according to my new design; FIG. 3 is a front end elevation view of the center folding table in an unfolded position according to my new design; FIG. 4 is a rear end elevation view of the center folding table in an unfolded position according to my new design; FIG. 5 is a left side elevation view of the center folding table in an unfolded position according to my new design; FIG. 6 is a right side elevation view of the center folding table in an unfolded position according to my new design; FIG. 7 is a top plan view of the center folding table in an unfolded position according to my new design; FIG. 8 is a bottom plan view of the center folding table in an unfolded position according to my new design; FIG. 9 is a top perspective view of the center folding table in a folded position according to my new design; FIG. 10 is a front end elevation view of the center folding table in a folded position according to my new design; FIG. 11 is a rear end elevation view of the center folding table in a folded position according to my new design; FIG. 12 is a left side elevation view of the center folding table in a folded position according to my new design; FIG. 13 is a right side elevation view of the center folding table in a folded position according to my new design; FIG. 14 is a top plan view of the center folding table in a folded position according to my new design; and, FIG. 15 is a bottom plan view of the center folding table in a folded position according to my new design.

1 Claim, 11 Drawing Sheets

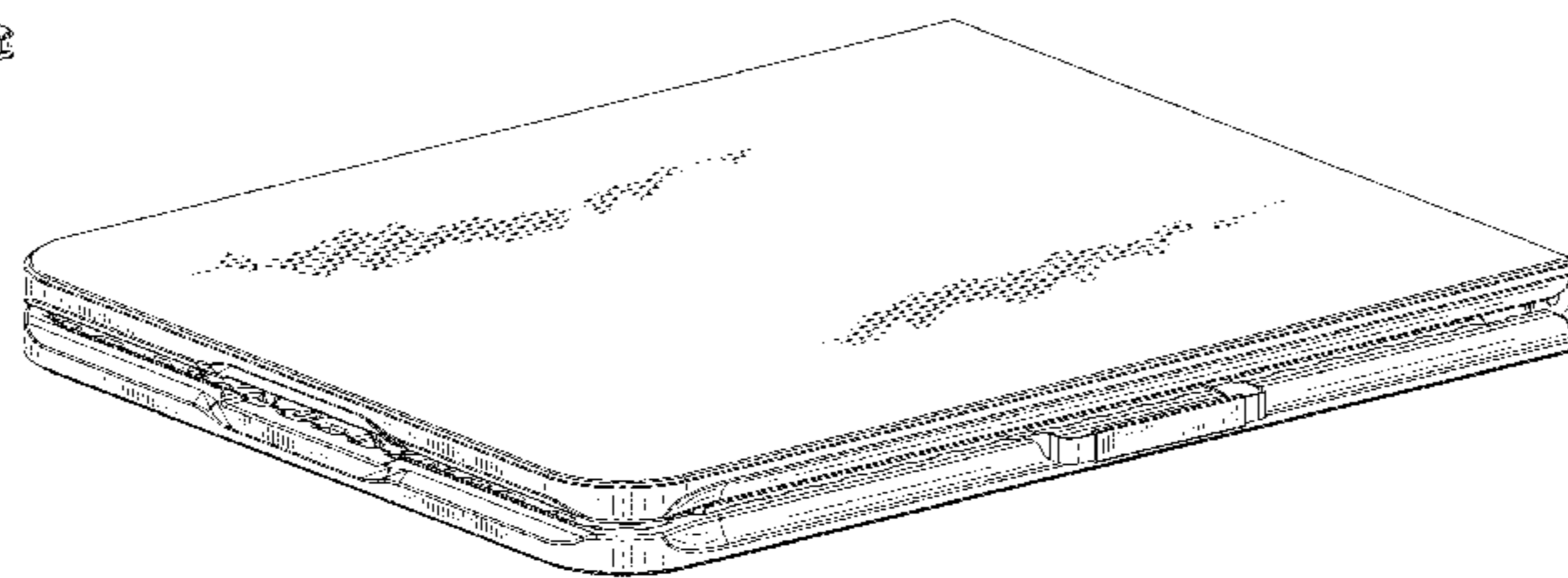
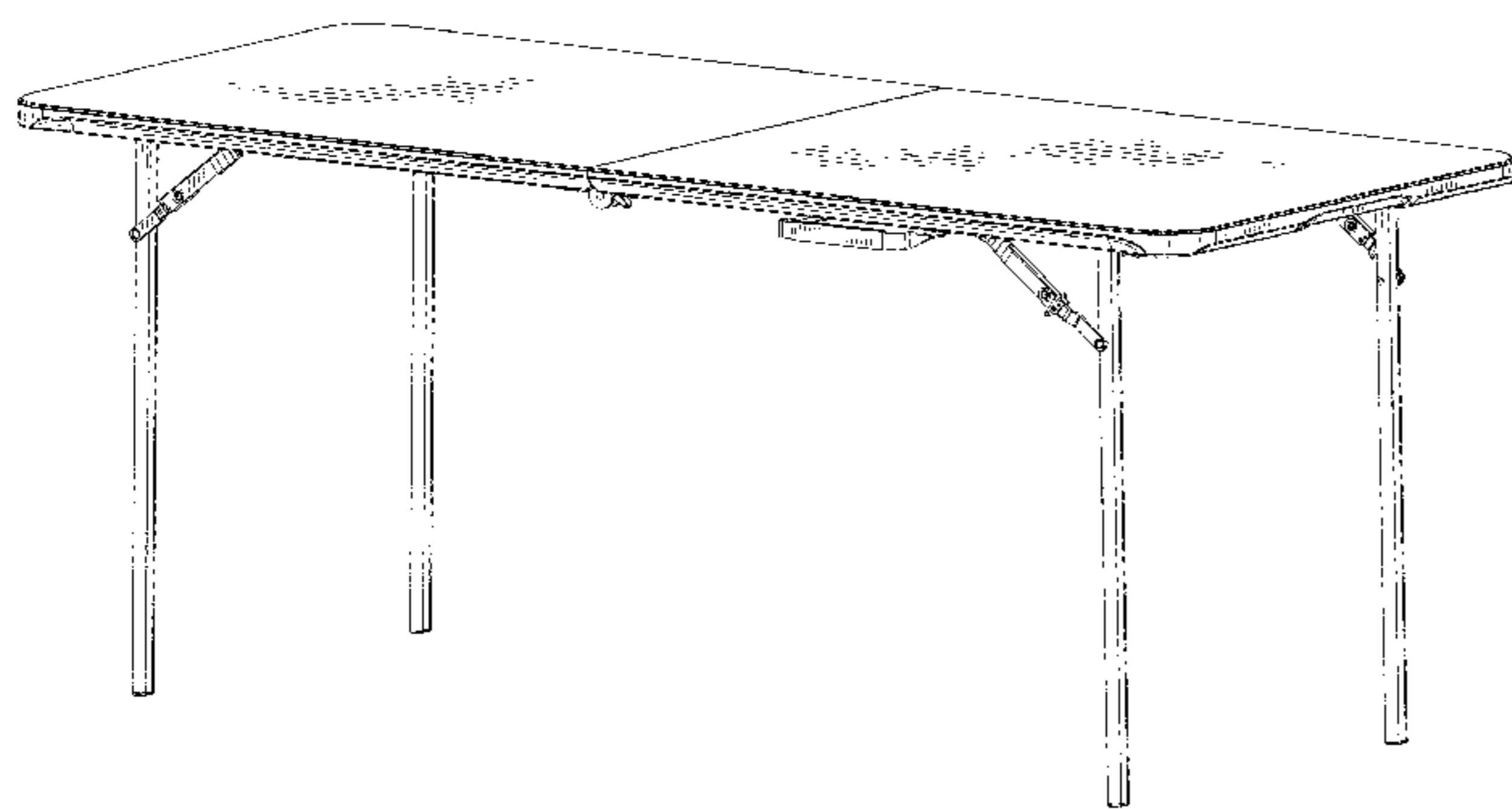

(56)

References Cited

U.S. PATENT DOCUMENTS

| | | | | |
|--------------|------|---------|----------------|-------------|
| 6,334,400 | B1 * | 1/2002 | Nien | A47B 3/087 |
| | | | | 108/115 |
| 7,150,237 | B2 | 12/2006 | Lin et al. | |
| 7,621,224 | B2 | 11/2009 | Lin et al. | |
| D742,146 | S | 11/2015 | Lin | |
| D750,402 | S | 3/2016 | Lin | |
| D774,808 | S | 12/2016 | Lin | |
| D777,486 | S | 1/2017 | Lin | |
| D781,628 | S | 3/2017 | Lin | |
| 9,750,338 | B2 * | 9/2017 | Turner | A47B 3/0818 |
| 9,913,531 | B1 | 3/2018 | Wang | |
| 10,485,333 | B1 * | 11/2019 | Tan | A47C 11/00 |
| 2005/0241551 | A1 * | 11/2005 | Neunzert | A47B 3/00 |
| | | | | 108/132 |
| 2016/0227919 | A1 * | 8/2016 | Turner | A47B 3/083 |
| 2016/0270522 | A1 * | 9/2016 | Winter | A47B 3/087 |
| 2018/0279768 | A1 * | 10/2018 | Leng | A47B 3/087 |
| 2018/0279771 | A1 * | 10/2018 | Leng | A47B 13/08 |
| 2019/0090626 | A1 * | 3/2019 | Leng | A47B 3/087 |
| 2019/0298054 | A1 * | 10/2019 | Clegg | A47B 9/20 |

* cited by examiner

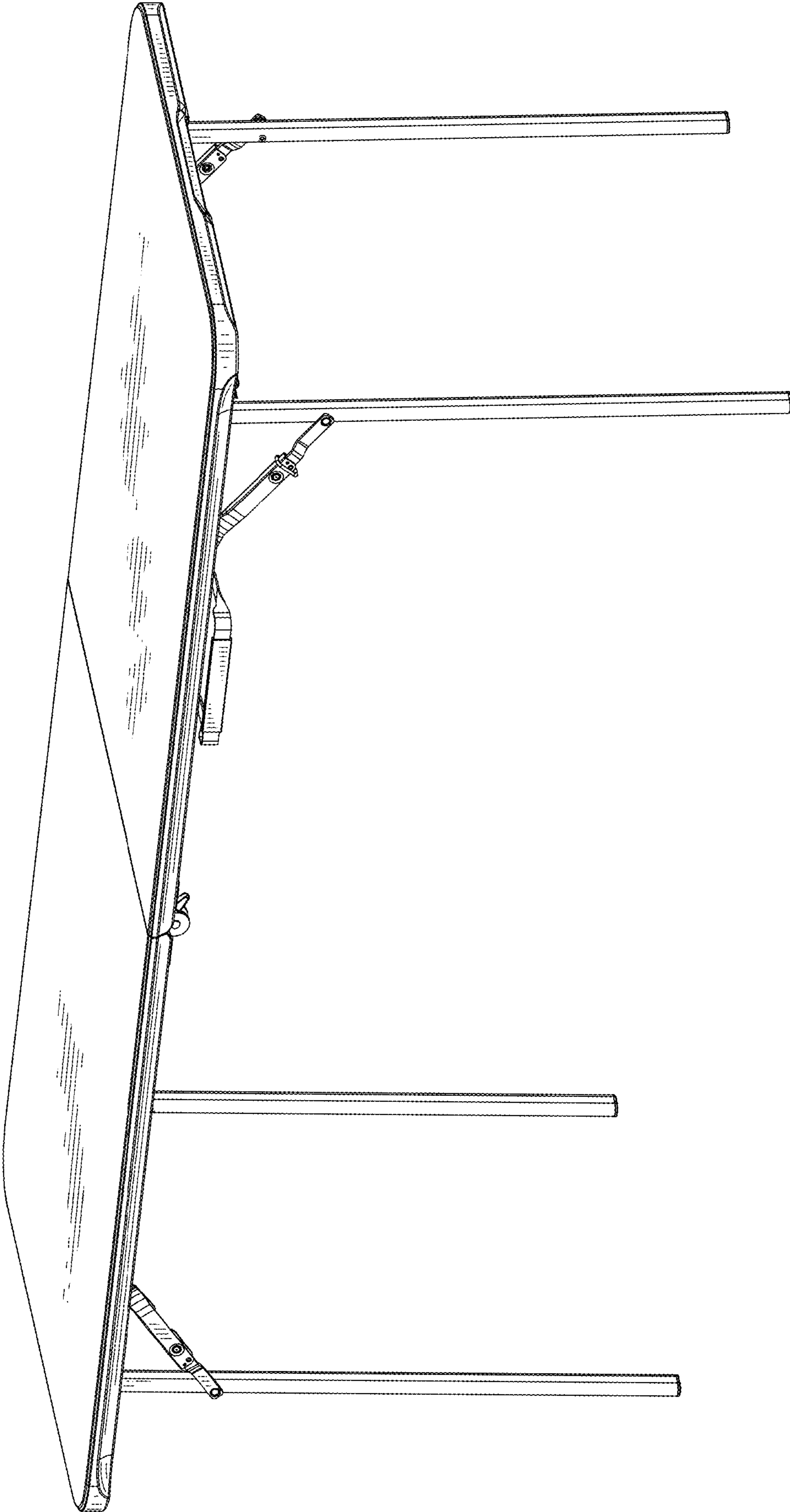

FIG. 1

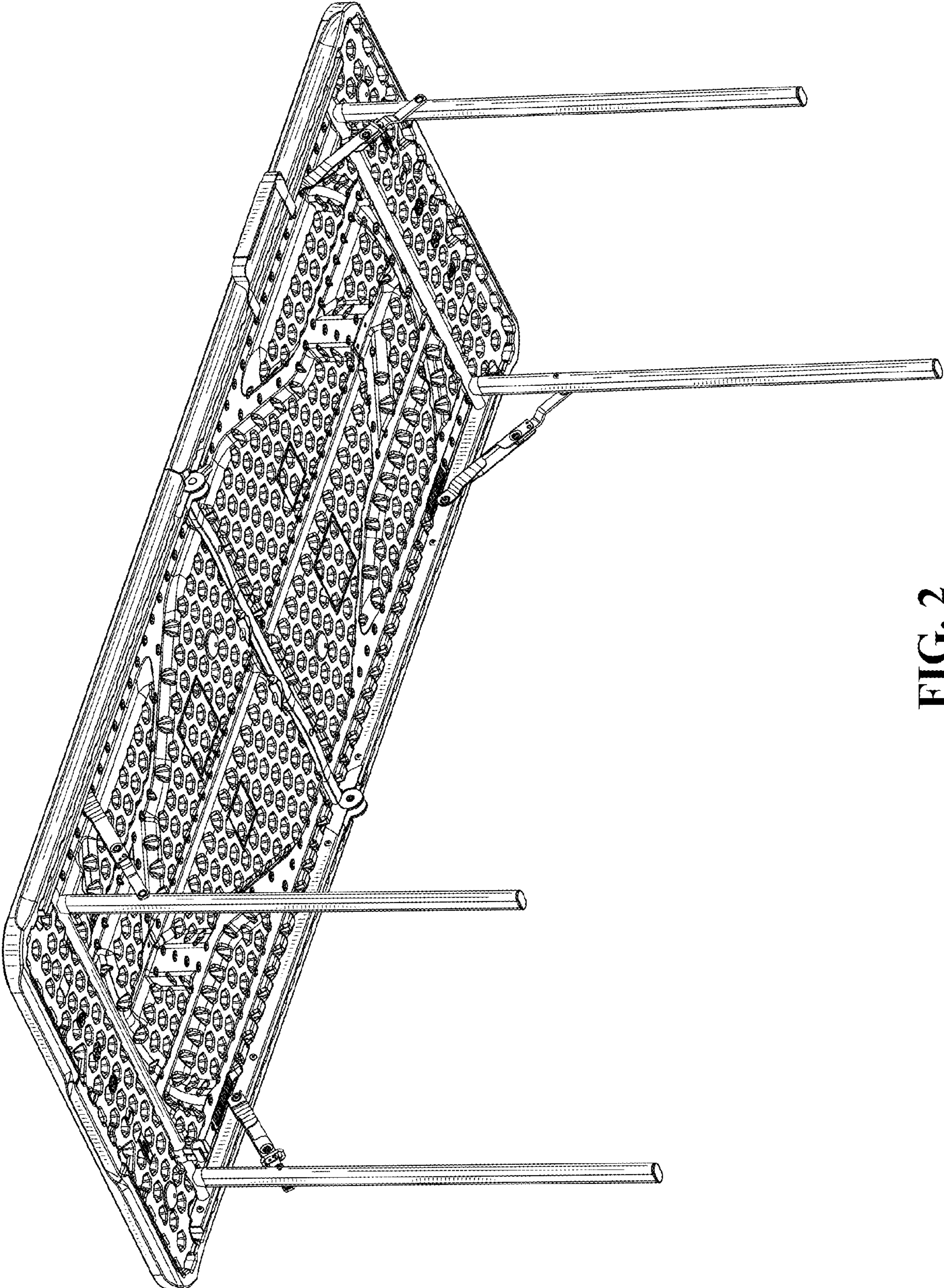

FIG. 2

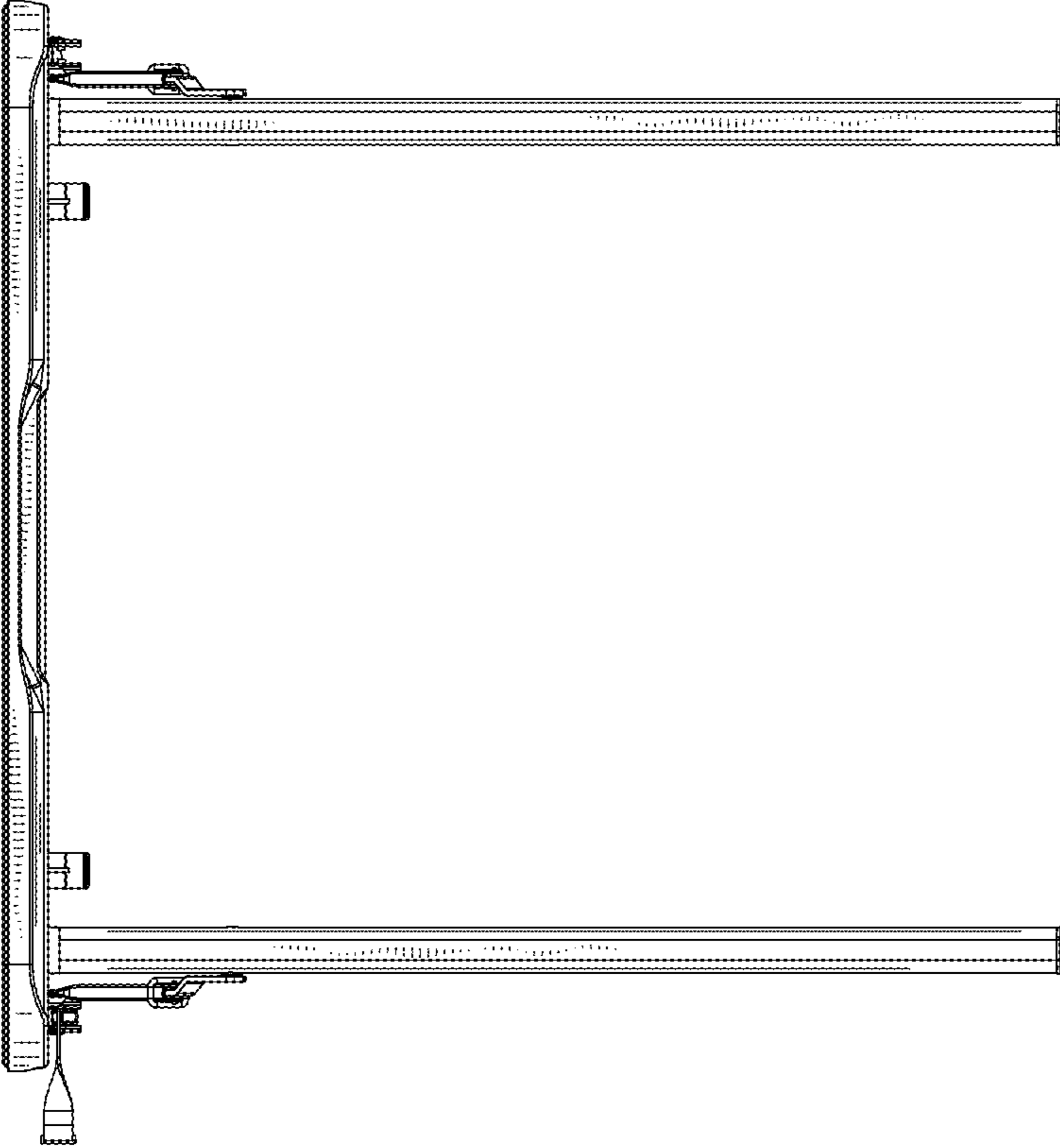

FIG. 4

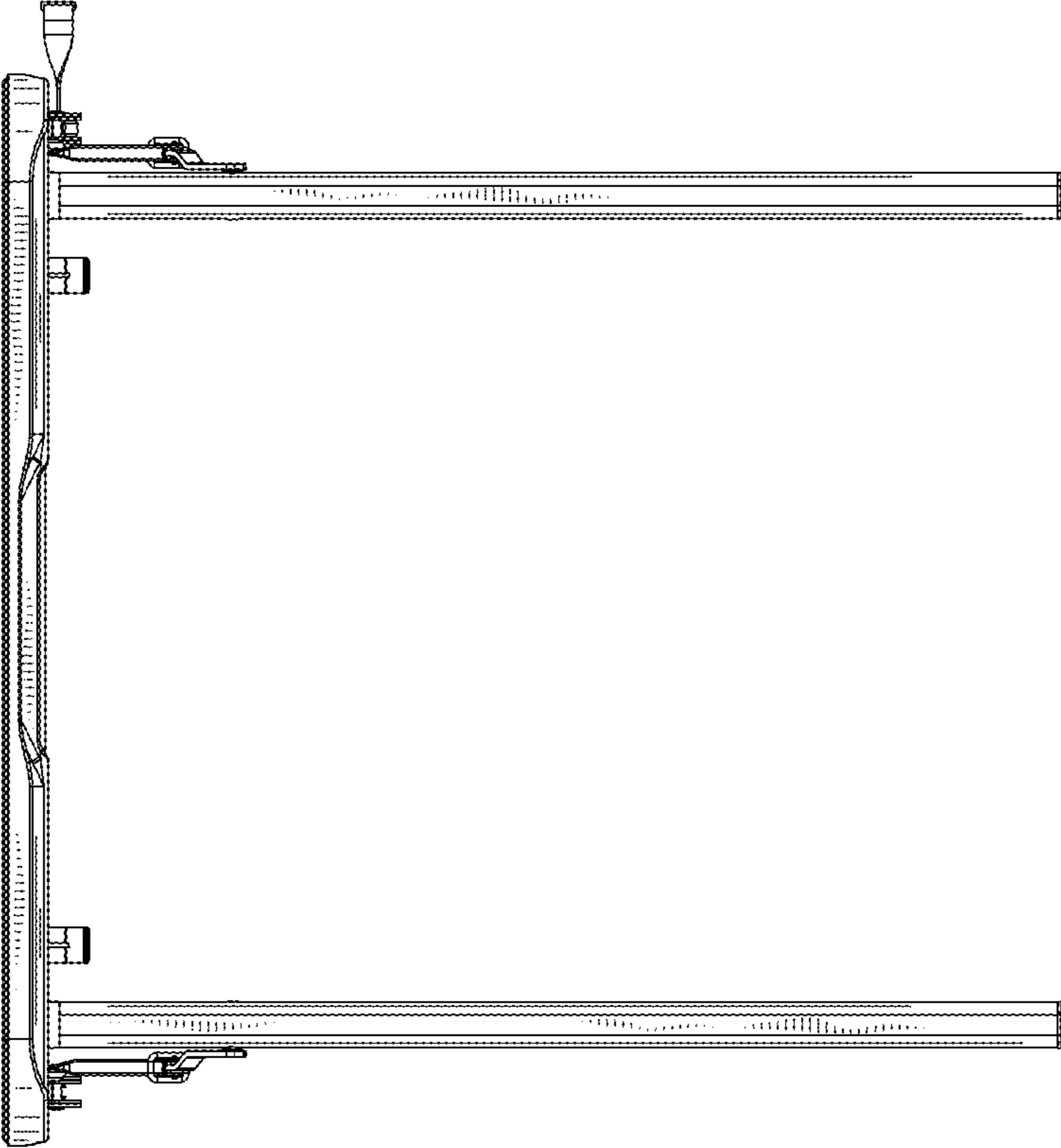

FIG. 3

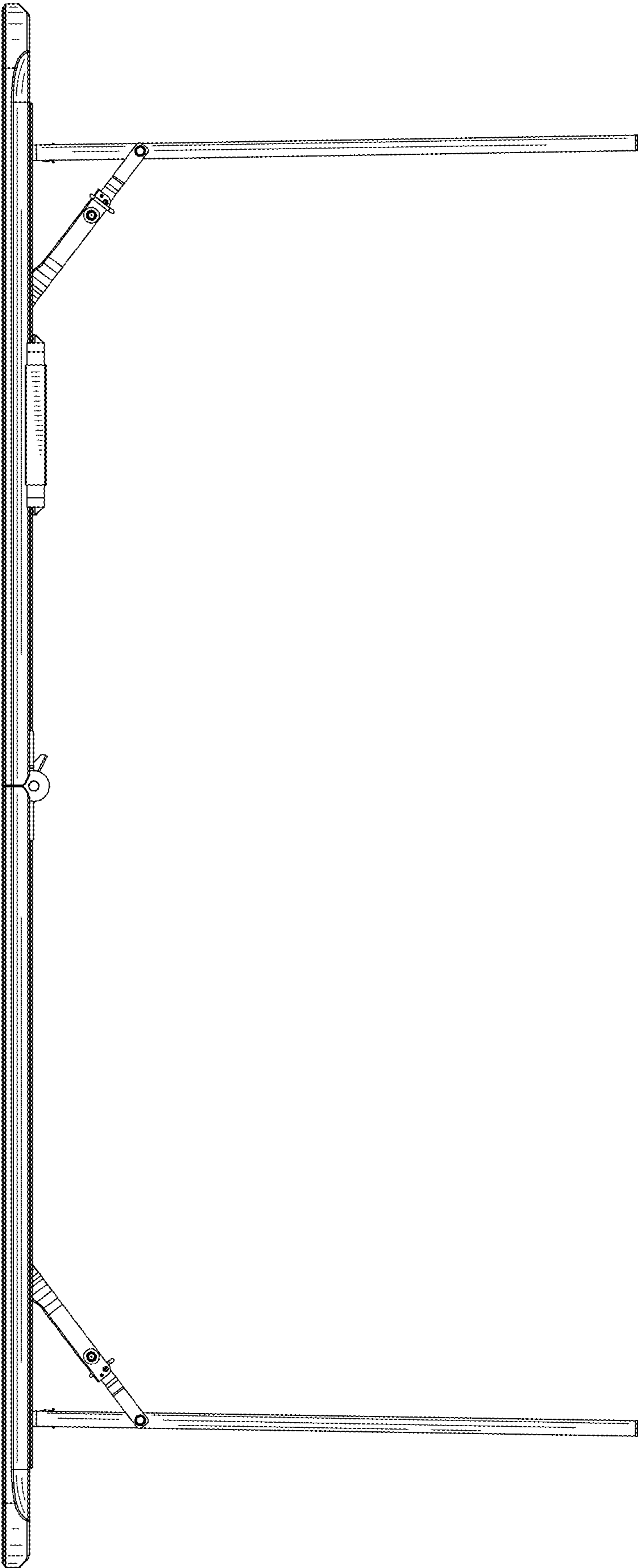

FIG. 5

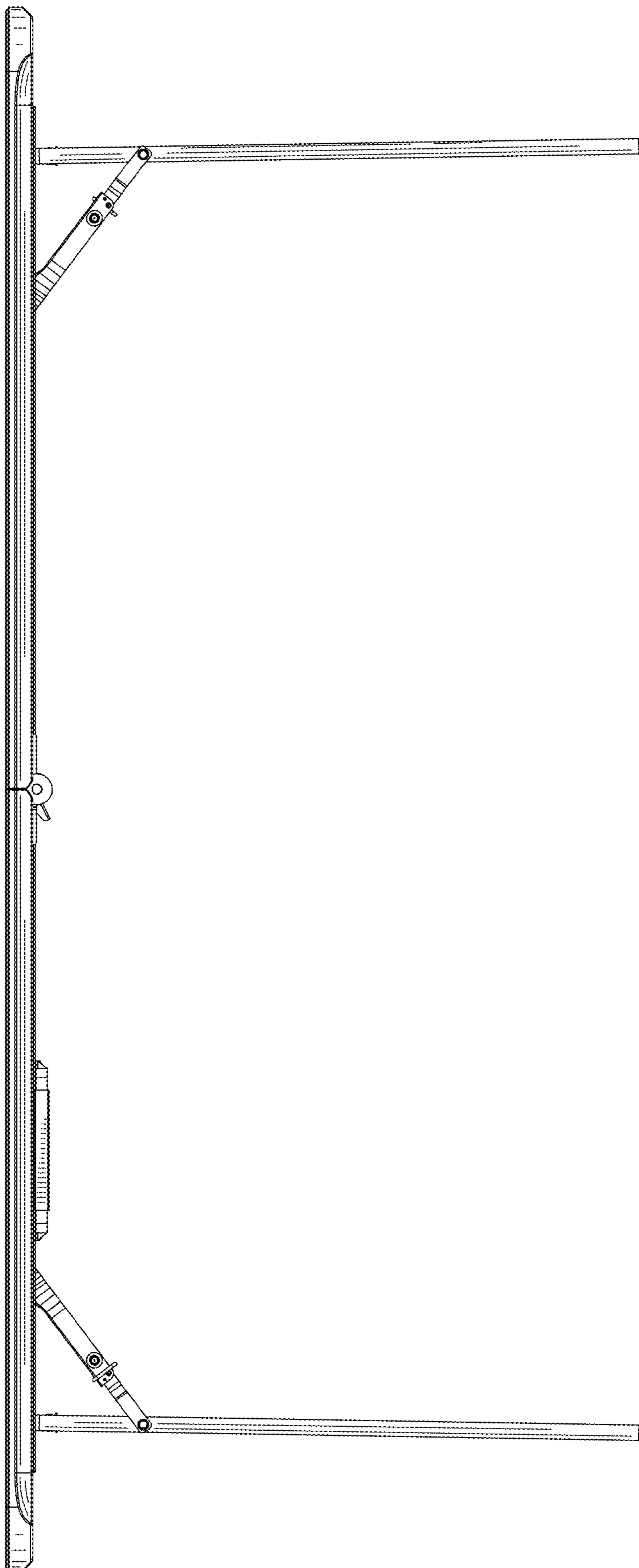

FIG. 6

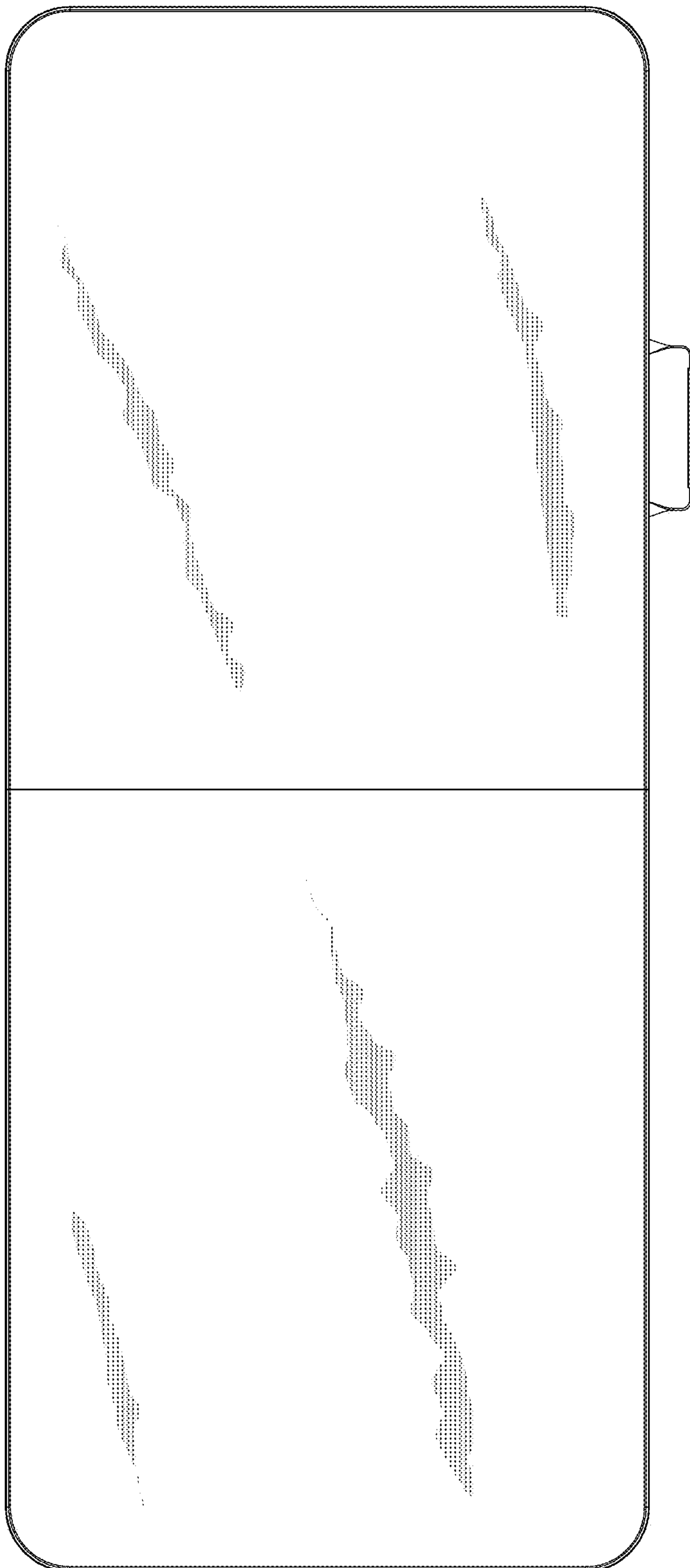

FIG. 7

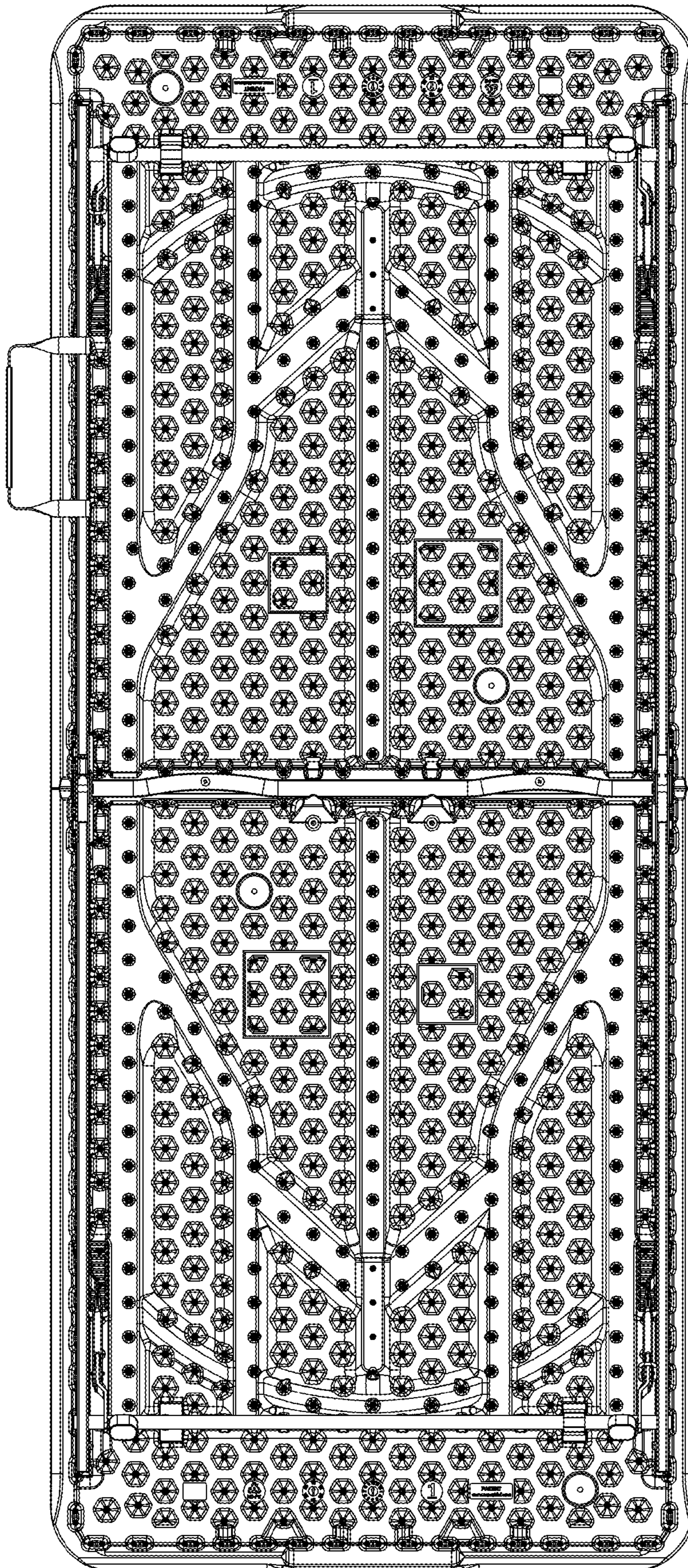

FIG. 8

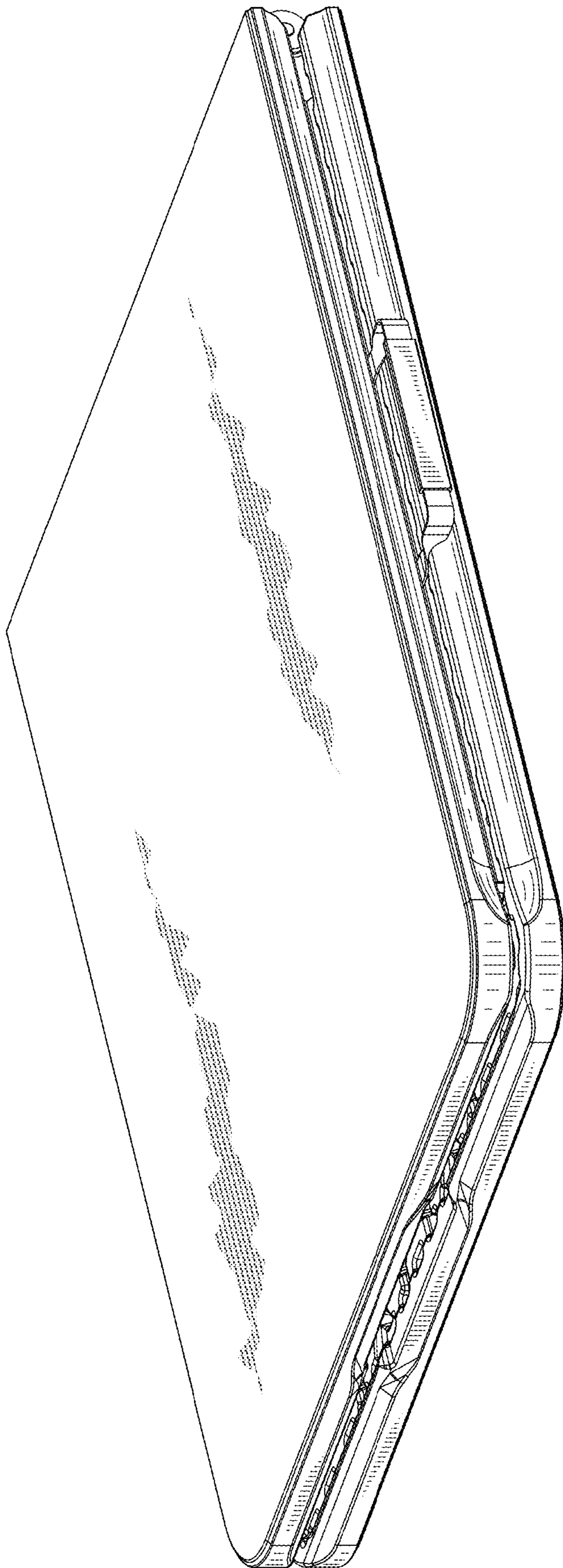

FIG. 9

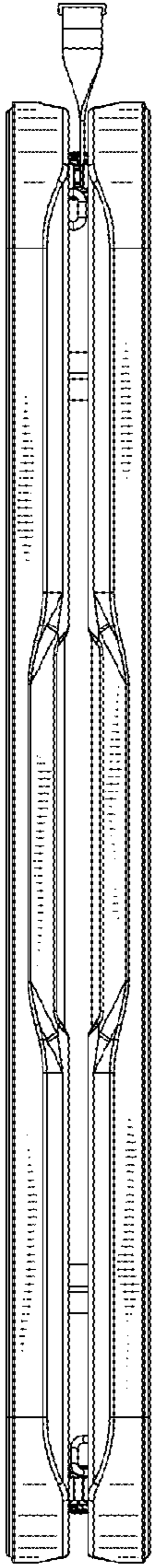

FIG. 10

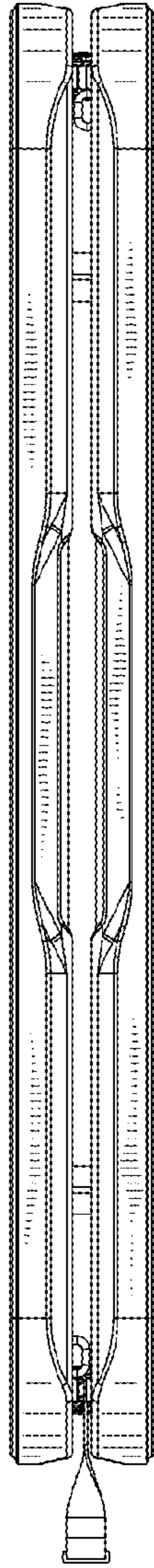

FIG. 11

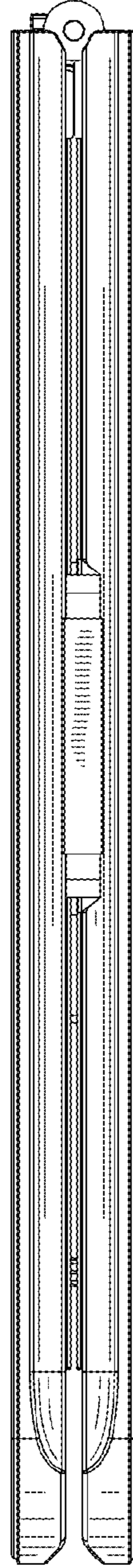

FIG. 12

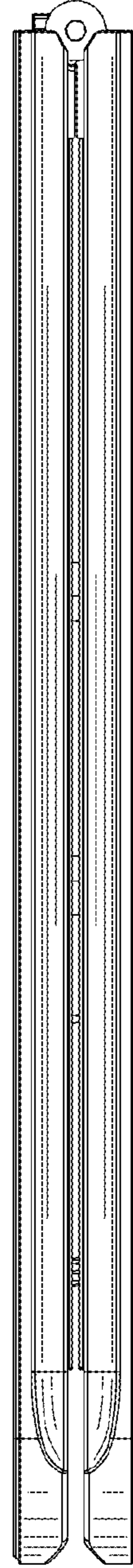

FIG. 13

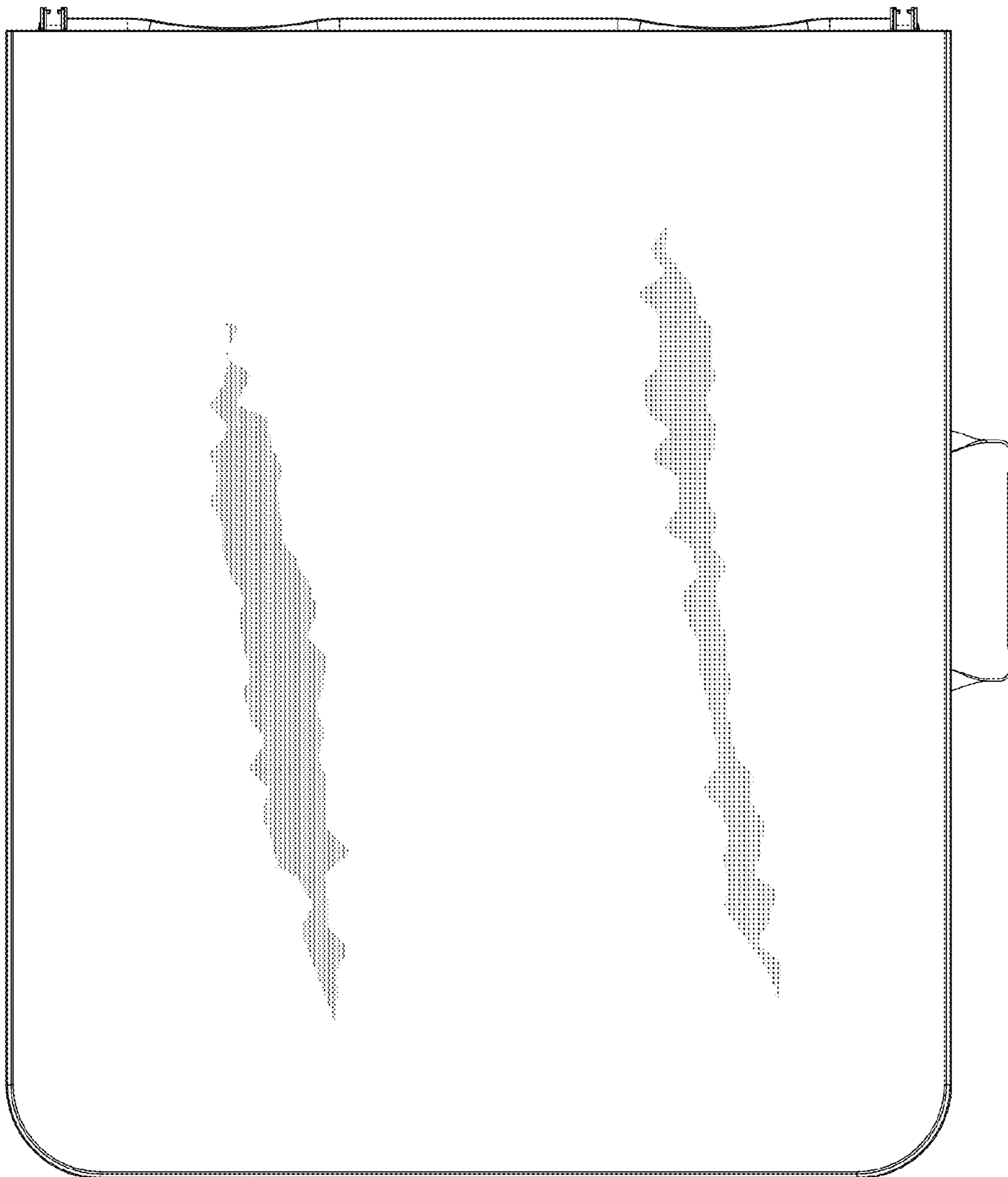

FIG. 14

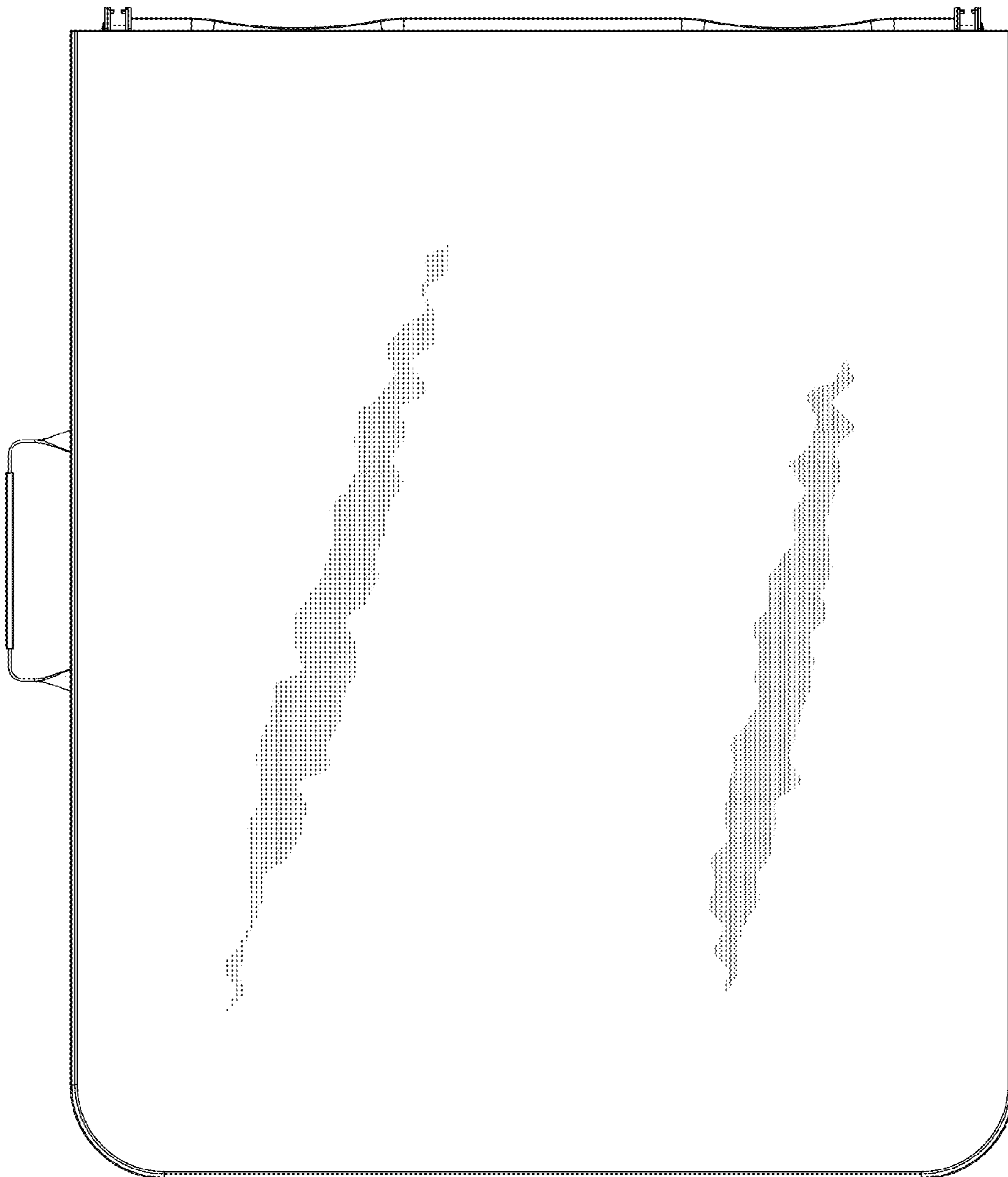

FIG. 15