



US00D884355S

(12) **United States Design Patent** (10) **Patent No.:** **US D884,355 S**
Diener et al. (45) **Date of Patent:** **** *May 19, 2020**

(54) **BRUSH HEAD**

(71) Applicant: **L’Oreal USA Creative, Inc.**, New York, NY (US)

(72) Inventors: **Alex Diener**, Seattle, WA (US); **Spencer Denton**, Seattle, WA (US); **Aaron David Poole**, Portland, OR (US); **Sam B. Goldberg**, Seattle, WA (US); **Suk P. Wong**, Sammamish, WA (US)

(73) Assignee: **L’Oréal USA Creative, Inc.**, New York, NY (US)

(*) Notice: This patent is subject to a terminal disclaimer.

(**) Term: **15 Years**

(21) Appl. No.: **29/646,320**

(22) Filed: **May 3, 2018**

(51) **LOC (12) Cl.** **28-03**

(52) **U.S. Cl.**
USPC **D4/102**

(58) **Field of Classification Search**
USPC D4/100, 102, 121, 127, 136; D28/7, 63, D28/73; D24/211, 214, 215; D32/35, 40
CPC . A47K 7/00; A47K 7/02; A47K 7/002; A47K 7/04; A47K 7/043; A61H 7/002; A61H 7/003; A61H 7/005; A61H 2205/022; A61H 2201/1692; A46B 2200/102
See application file for complete search history.

(56) **References Cited**

U.S. PATENT DOCUMENTS

6,820,299 B2 * 11/2004 Gavney, Jr. A46B 9/005 15/117
D514,328 S * 2/2006 Huang D24/211
D619,717 S * 7/2010 Toshima D24/152
D698,932 S * 2/2014 Brewer D24/211
D711,656 S * 8/2014 Brewer D4/102

D715,557 S * 10/2014 Brewer D4/102
D715,558 S * 10/2014 Brewer D4/102
D843,003 S * 3/2019 Huang D24/215
10,264,927 B2 * 4/2019 Brewer A46B 9/021
2016/0331106 A1 * 11/2016 Khormaei A46B 7/08
2017/0119144 A1 * 5/2017 Brewer A46B 15/001

(Continued)

FOREIGN PATENT DOCUMENTS

CN 302912274 * 8/2014

OTHER PUBLICATIONS

Clarisonic Mia Smart Sonic Cleansing System on QVC—YouTube [on-line]. Published Aug. 11, 2018; retrieved from the Internet May 3, 2019. URL: <<https://www.youtube.com/watch?v=-6wTO68myvI>>. (Year: 2018).*

(Continued)

Primary Examiner — Karen E Eldridge Powers
(74) *Attorney, Agent, or Firm* — Christensen O’Connor Johnson Kindness PLLC

(57) **CLAIM**

The ornamental design for a brush head, as shown and described.

DESCRIPTION

FIG. 1 is a top front right perspective view of a brush head in accordance with our new design;
FIG. 2 is a front elevation view thereof;
FIG. 3 is a rear elevation view thereof;
FIG. 4 is a top plan view thereof;
FIG. 5 is a bottom plan view thereof;
FIG. 6 is a left side elevation view thereof;
FIG. 7 is a right side elevation view thereof;
FIG. 8 is a top rear right perspective view thereof; and,
FIG. 9 is a perspective view showing the brush head.
The broken lines shown in the drawings illustrate portions of the brush head that form no part of the claimed design.

1 Claim, 8 Drawing Sheets

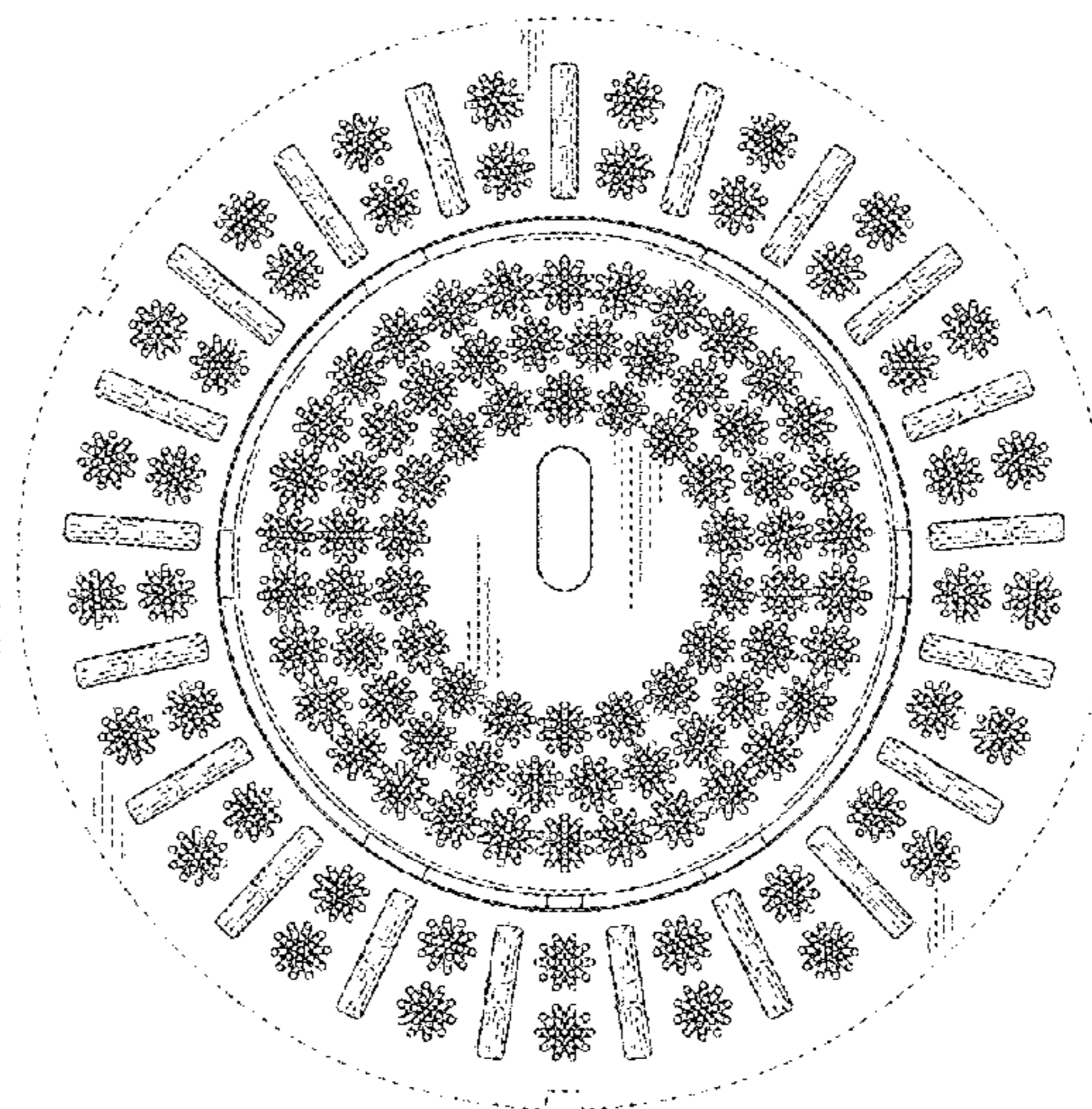
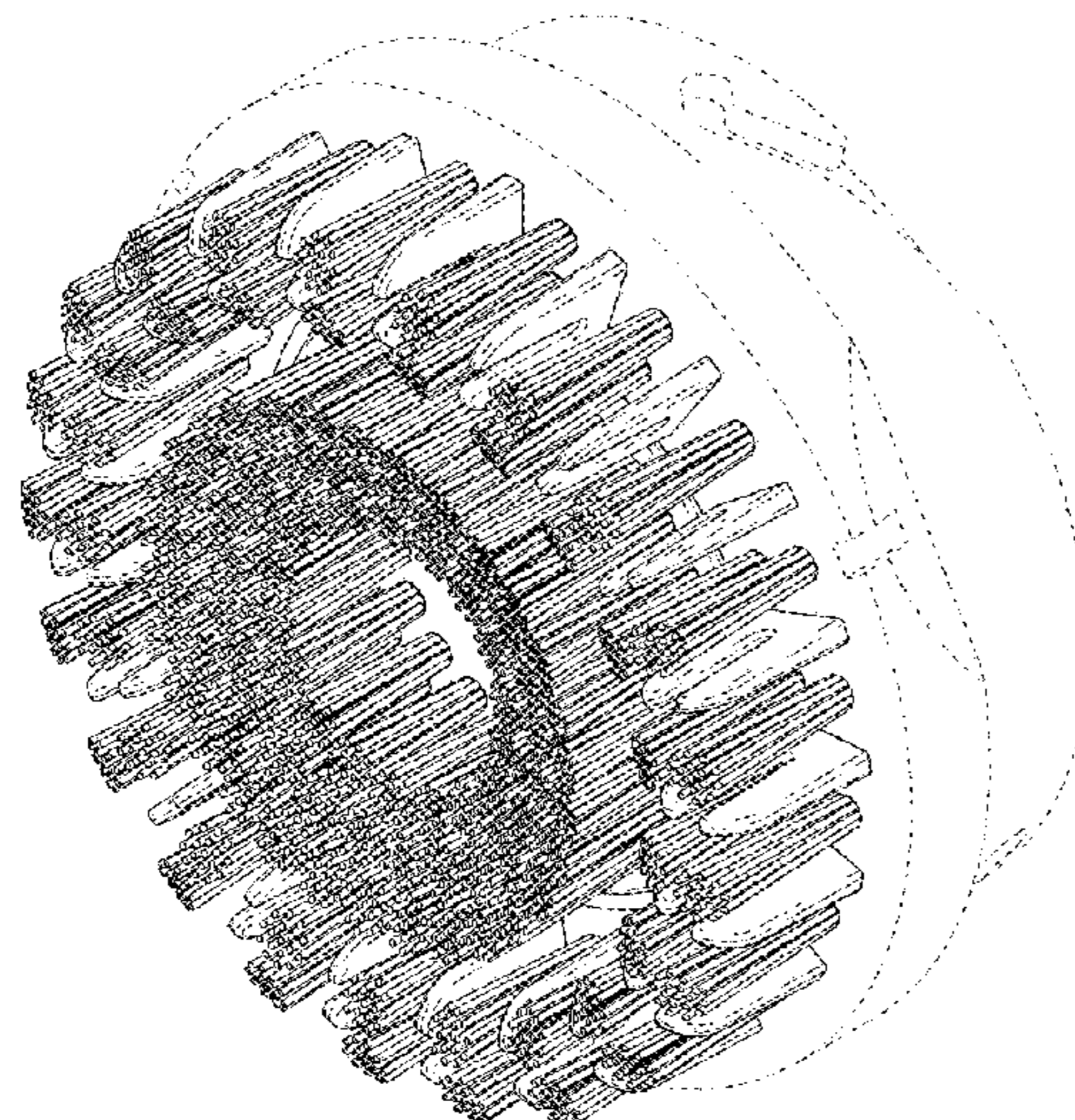

(56)

References Cited

U.S. PATENT DOCUMENTS

2017/0194849 A1* 7/2017 Meginniss, III H02K 33/12
2018/0098615 A1* 4/2018 George A45D 40/262
2019/0029411 A1* 1/2019 Brewer A46B 15/001

OTHER PUBLICATIONS

Mia Prima Sonic Facial Cleansing Brush—Clarisonic [on-line].
Published Apr. 21, 2019; retrieved from the Internet May 3, 2019.
URL: <<https://web.archive.org/web/20190421061531/https://www.Clarisonic.com/face-brushes/mia-prima-sonic-facial-cleansing-brush/CL420.html>>. (Year: 2019).*

Screenshots of video of interchangeable brush heads for Clarisonic
Mia Prima facial brush [on-line]. Published Apr. 21, 2019; retrieved
from Internet May 3, 2019. URL: <<https://web.archive.org/web/20190421061531/https://www.Clarisonic.com/face-brushes/mia-prima-sonic-facial-cleansing-brush/CL420.html>>. (Year: 2019).*

Screenshots of video, “The Future of Beauty is Here—Mia Smart |
Clarisonic,” [on-line]. Published Aug. 10, 2018; retrieved from
Internet May 3, 2019. URL: <<https://www.youtube.com/watch?v=rQd3VwAQdT0>>. (Year: 2018).*

* cited by examiner

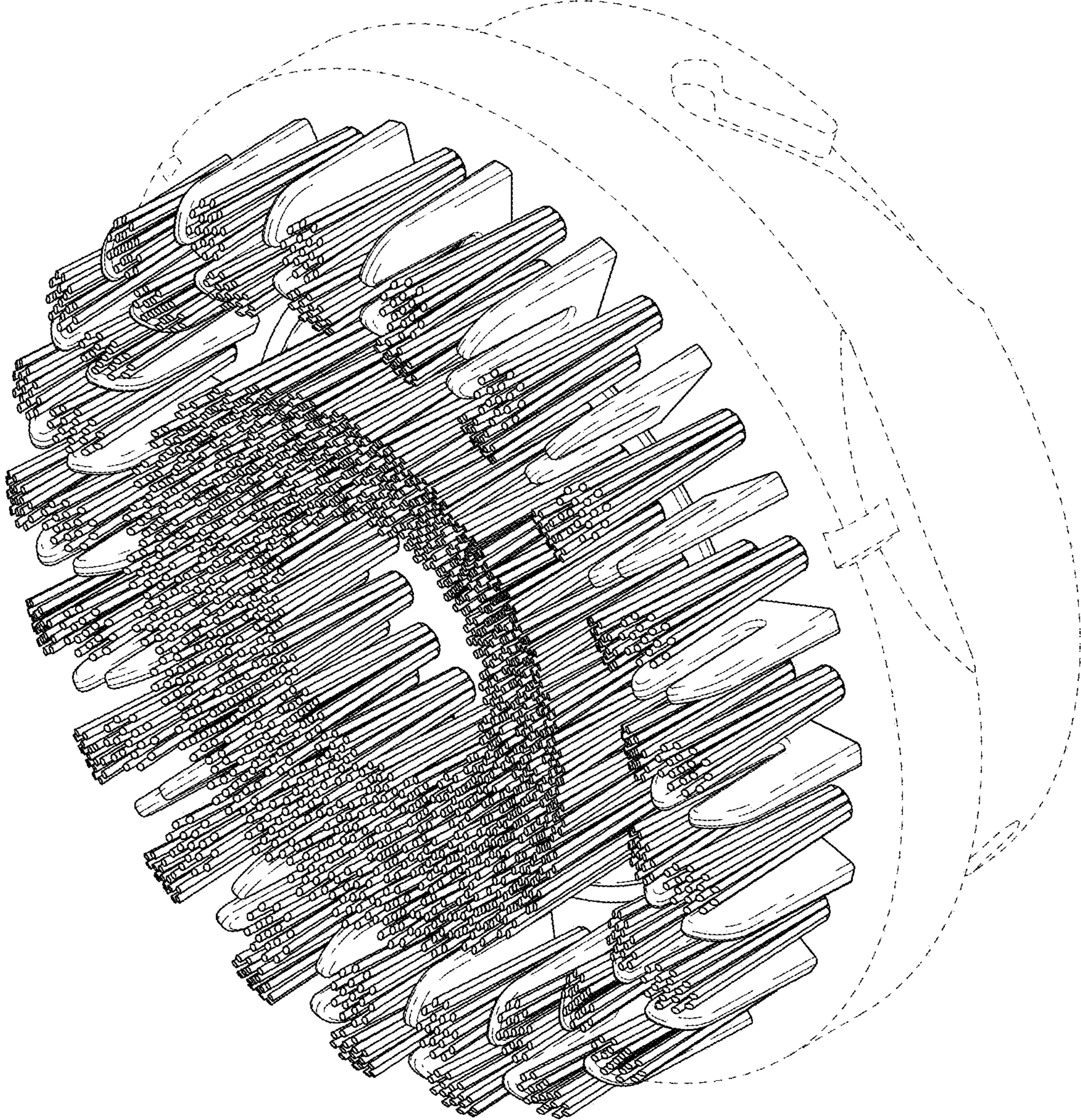

Fig. 1

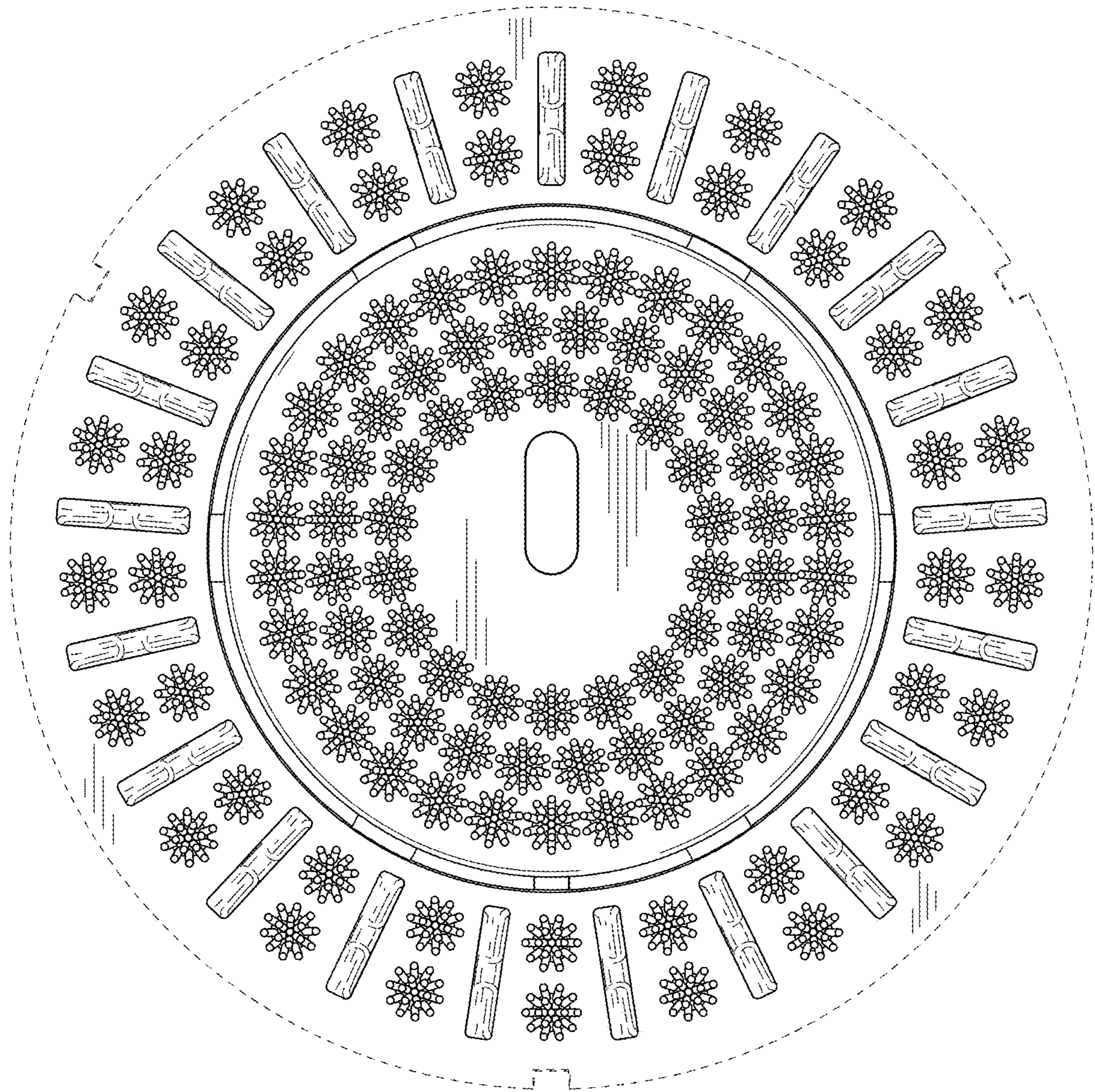

Fig. 2

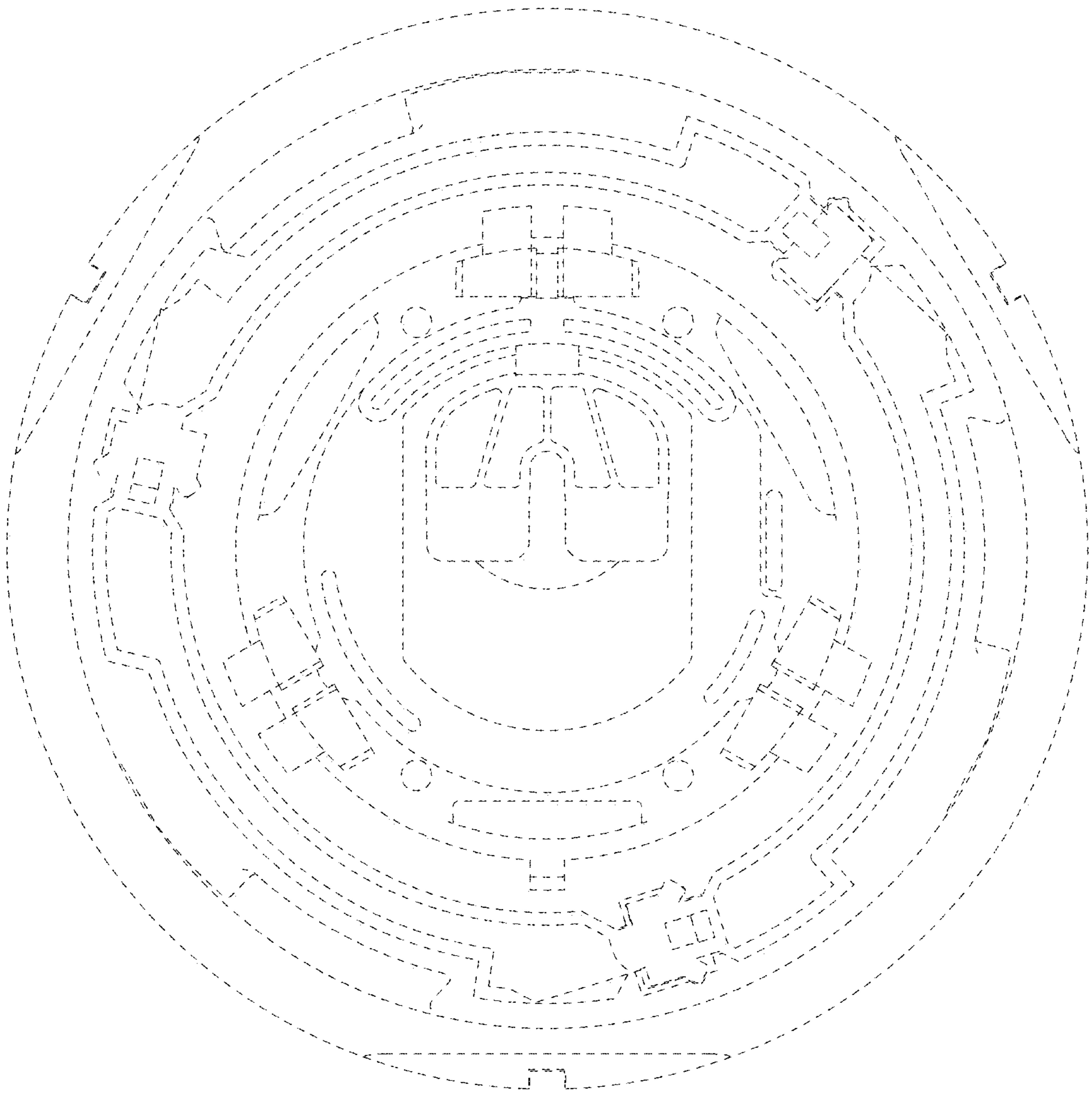

Fig. 3

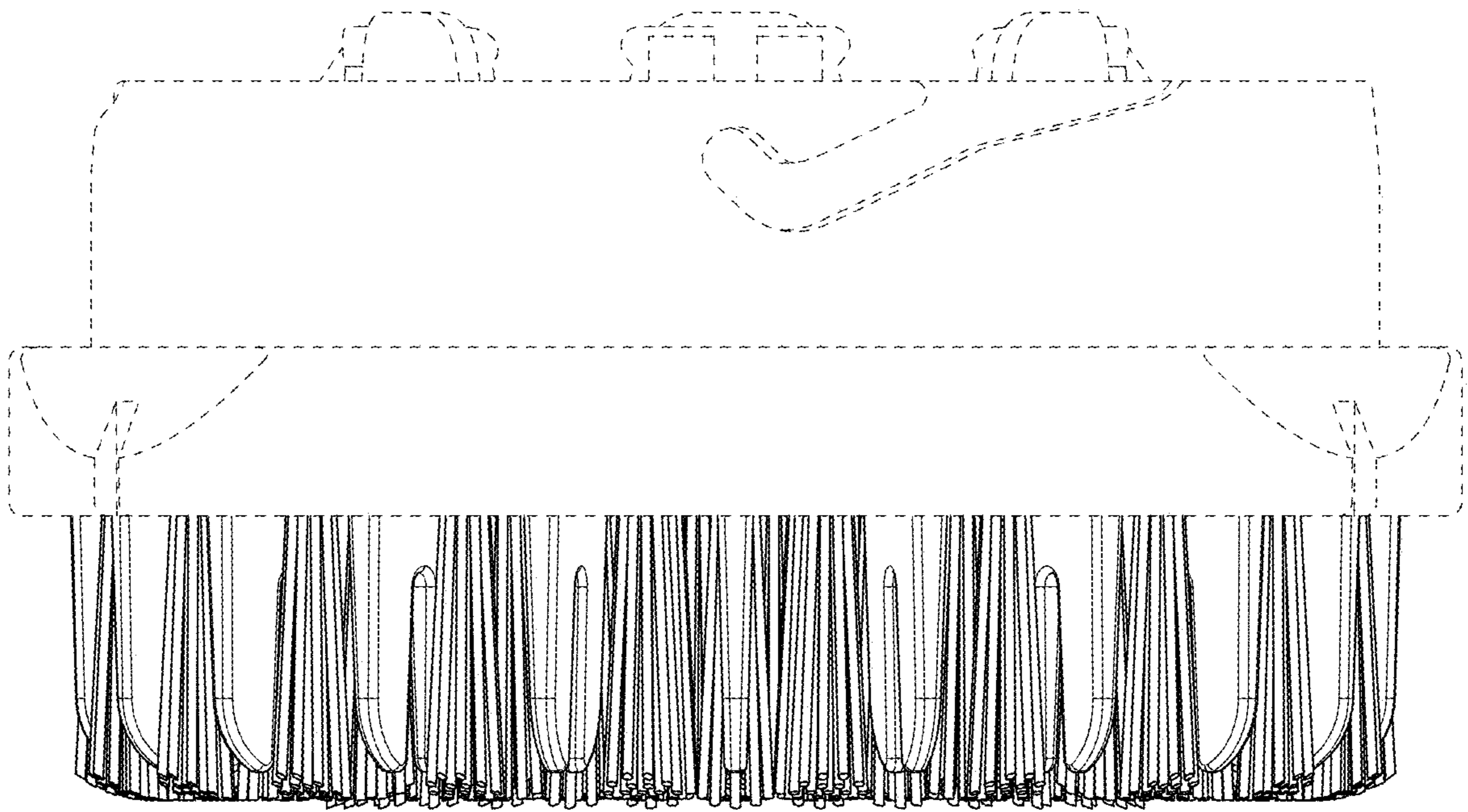

Fig. 4

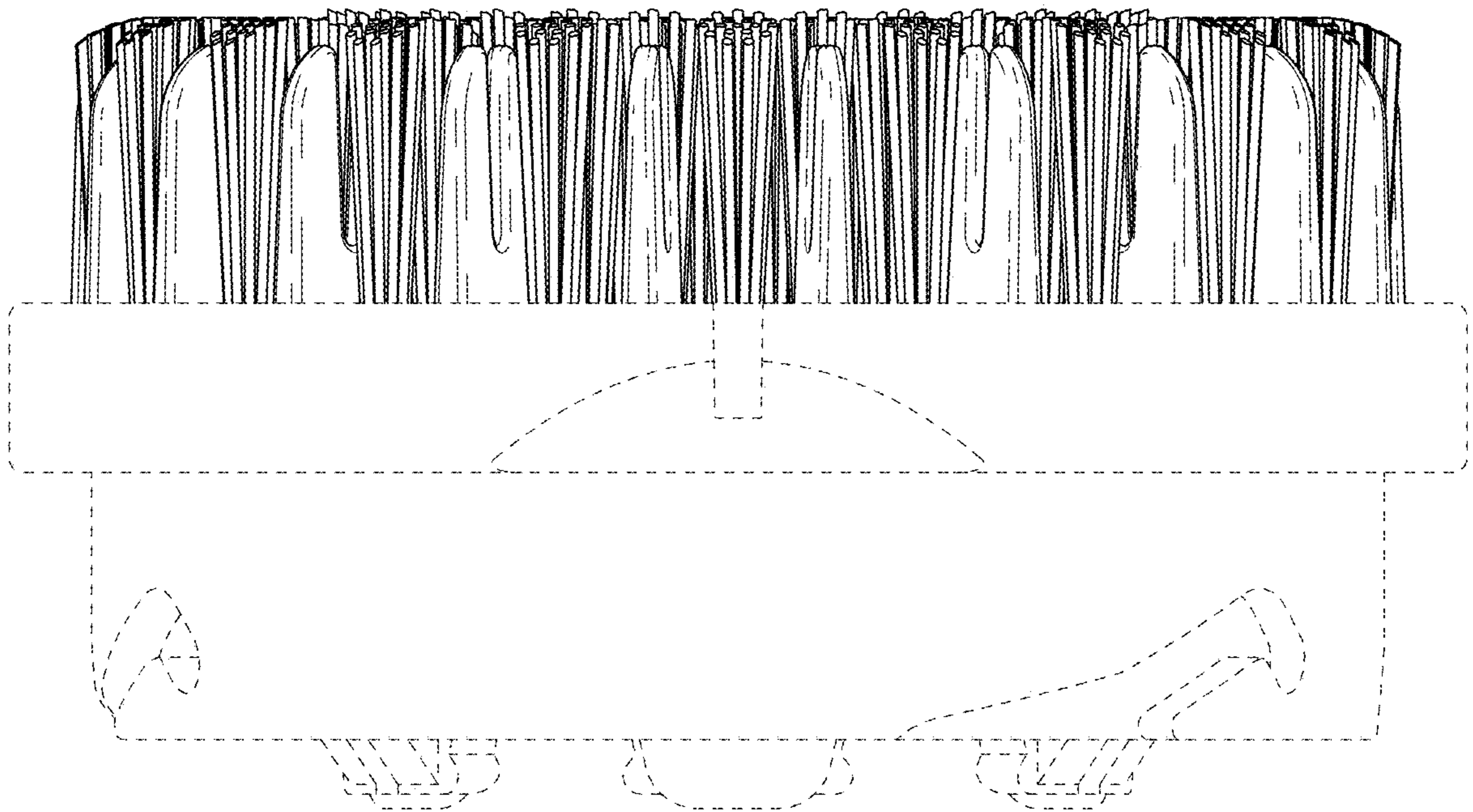

Fig. 5

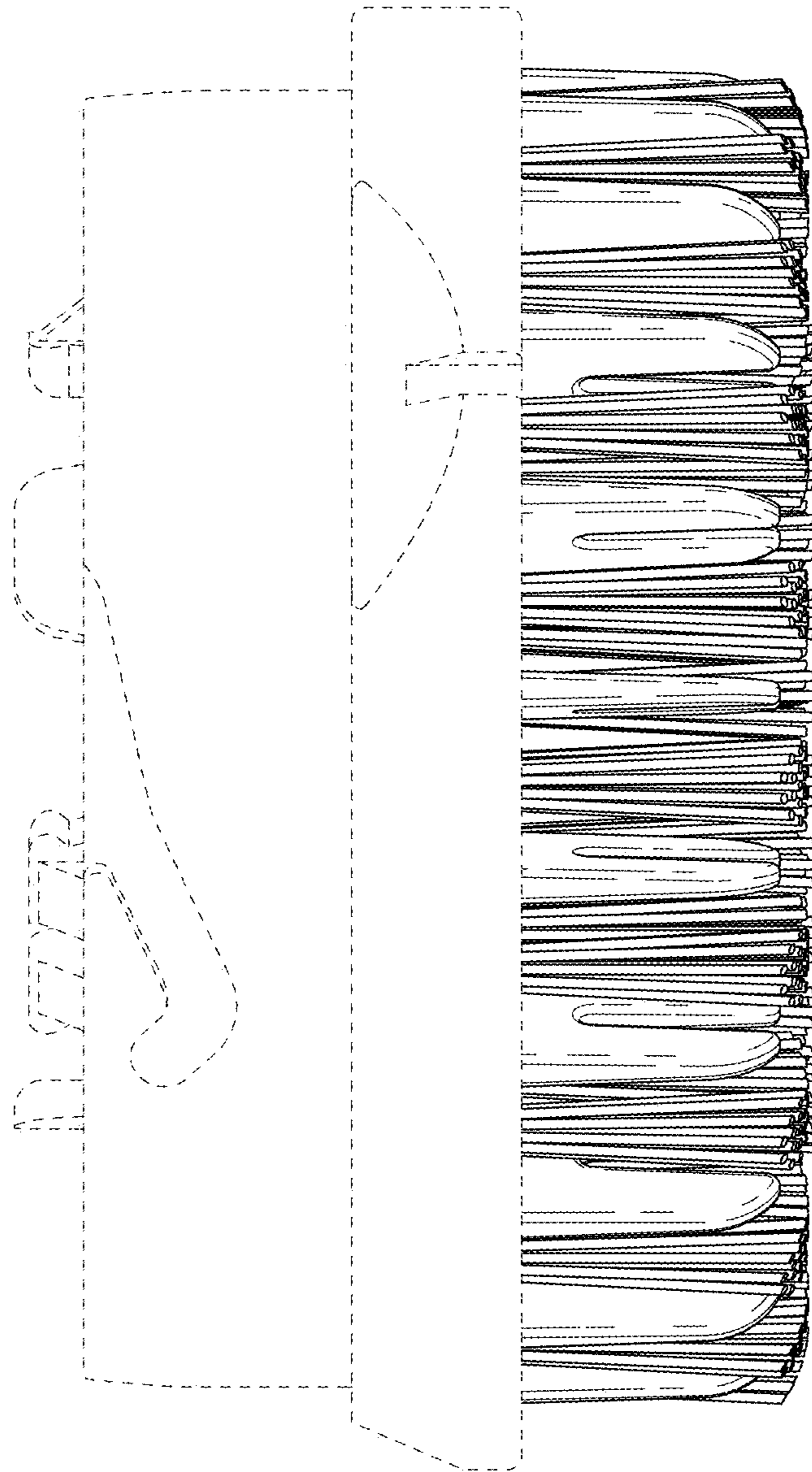

Fig. 6

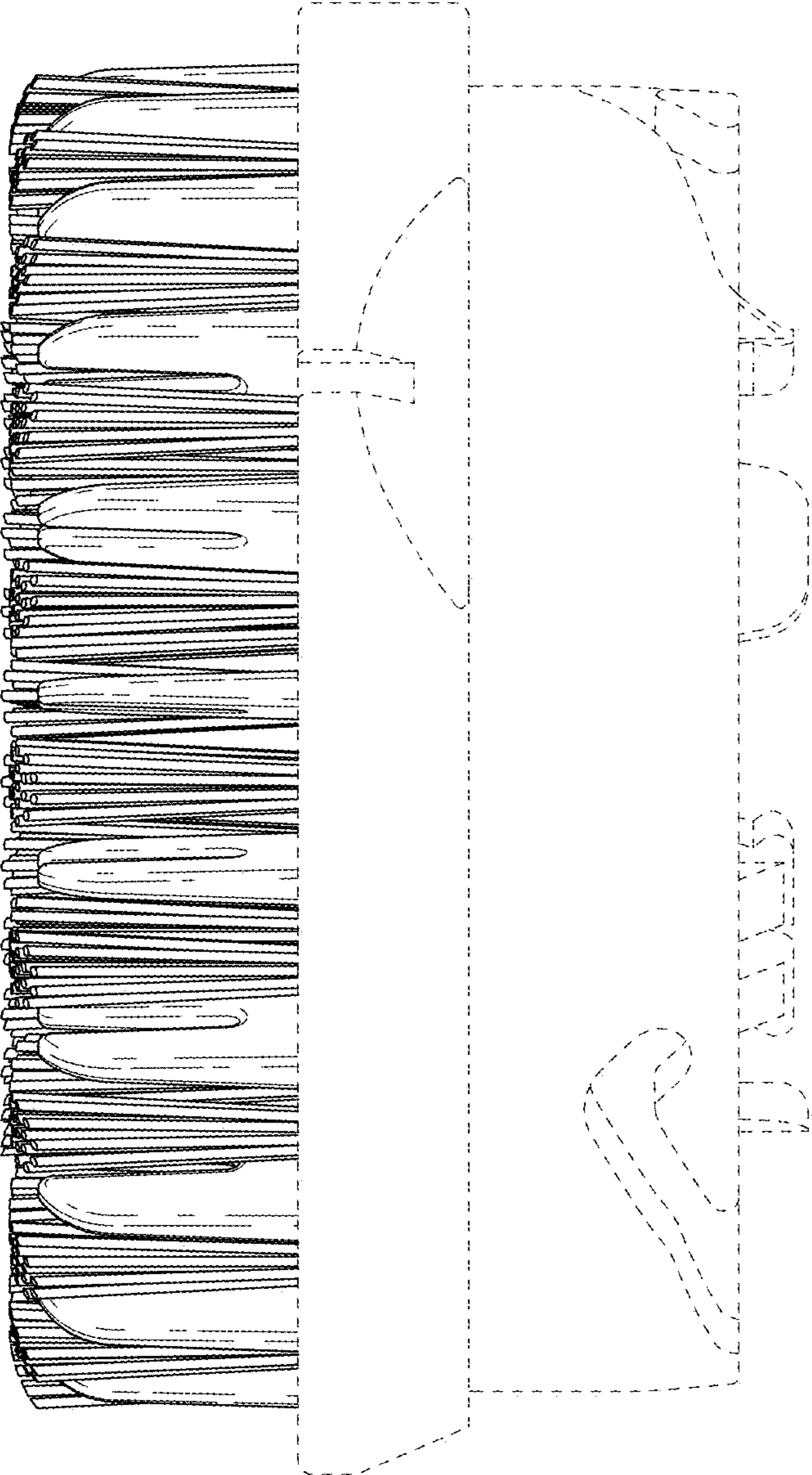

Fig. 7

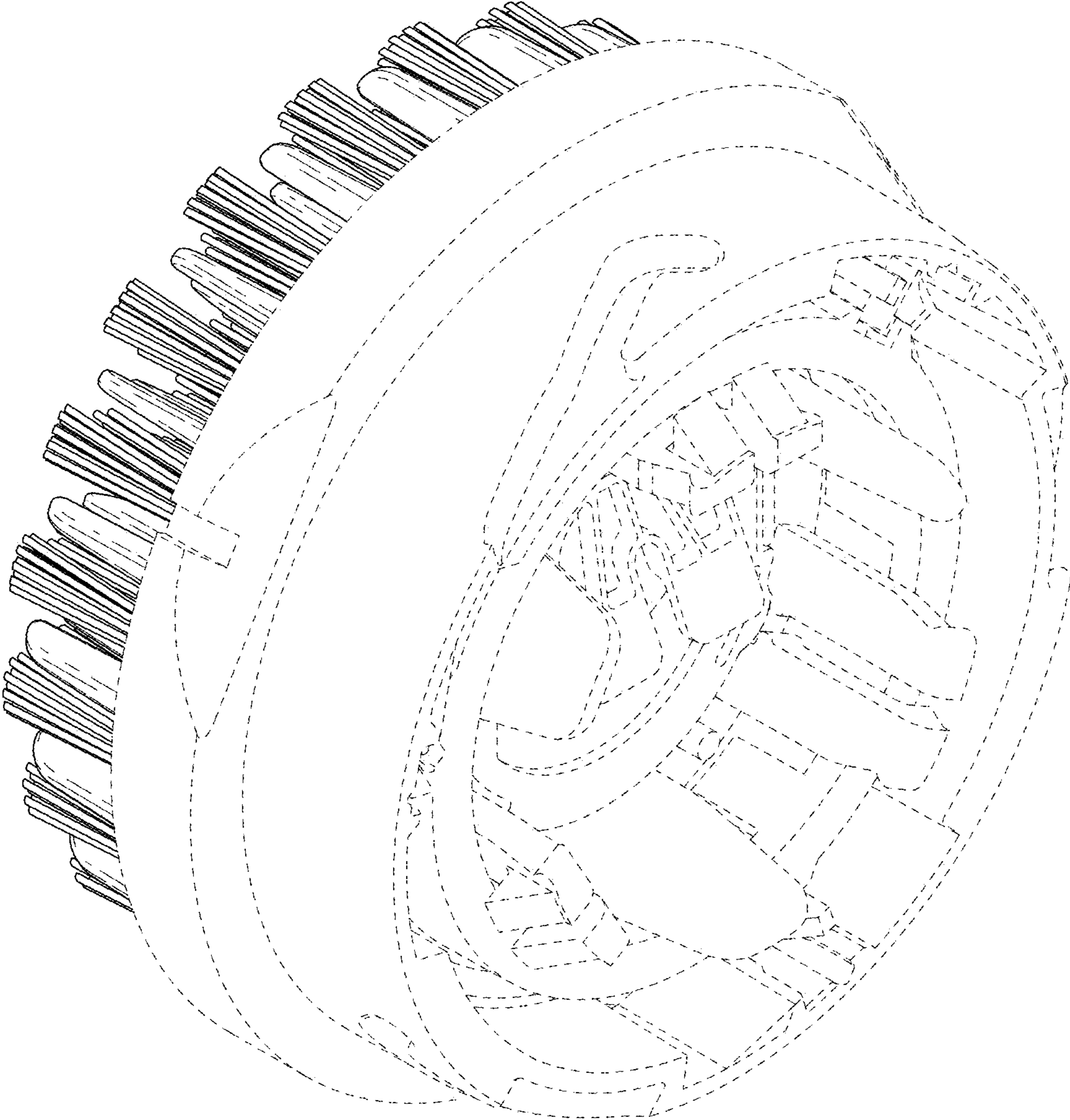

Fig. 8

