



US00D884337S

(12) **United States Design Patent**
Kern

(10) **Patent No.:** **US D884,337 S**

(45) **Date of Patent:** **** May 19, 2020**

(54) **SHOULDER BAG**

(71) Applicant: **TR Apparel, LLC**, New York, NY
(US)

(72) Inventor: **Ellen Kern**, New York, NY (US)

(73) Assignee: **TR APPAREL, LLC**, New York, NY
(US)

(**) Term: **15 Years**

(21) Appl. No.: **29/677,899**

(22) Filed: **Jan. 24, 2019**

(51) **LOC (12) Cl.** **03-01**

(52) **U.S. Cl.**
USPC **D3/232**

(58) **Field of Classification Search**
USPC D3/232–233, 240–243, 245–246
CPC A45C 1/024; A45C 3/06
See application file for complete search history.

(56) **References Cited**

U.S. PATENT DOCUMENTS

D372,795 S *	8/1996	Swinford	D3/233
D406,456 S *	3/1999	McDermott	D3/201
D607,205 S *	1/2010	Sabbah	D3/243
D762,974 S *	8/2016	Romano	D3/243
D803,555 S *	11/2017	Maier	D3/243
D804,170 S *	12/2017	Maier	D3/243
D857,384 S *	8/2019	Vaccarello	D3/243
D868,461 S *	12/2019	Gvasalia	D3/243

* cited by examiner

Primary Examiner — Holly H Baynham

(74) *Attorney, Agent, or Firm* — Sheppard, Mullin,
Richter & Hampton LLP

(57) **CLAIM**

I claim the ornamental design for a shoulder bag, as shown and described.

DESCRIPTION

FIG. 1 is a top, front, and right side perspective view of an ornamental design for a shoulder bag;
 FIG. 2 is a front side elevational view thereof;
 FIG. 3 is a rear side elevational view thereof;
 FIG. 4 is a right side elevational view thereof;
 FIG. 5 is a left side elevational view thereof;
 FIG. 6 is a top plan view thereof;
 FIG. 7 is a bottom plan view thereof;
 FIG. 8 is a right side elevational view of the shoulder bag with the flap unfolded;
 FIG. 9 is a front side elevational view of the shoulder bag with the flap unfolded;
 FIG. 10 is a top plan view of the shoulder bag with the flap unfolded;
 FIG. 11 is a right side elevational view of the shoulder bag with the flap unfolded and the interior stretched open;
 FIG. 12 is a top plan view of the shoulder bag with the flap unfolded and the interior stretched open; and,
 FIG. 13 is a front side elevational view of the shoulder bag with the shoulder strap length adjusted.
 The broken lines depicting the stitching of the shoulder bag shown in the drawings are for illustrative purposes only and form no part of the claimed design.

1 Claim, 12 Drawing Sheets

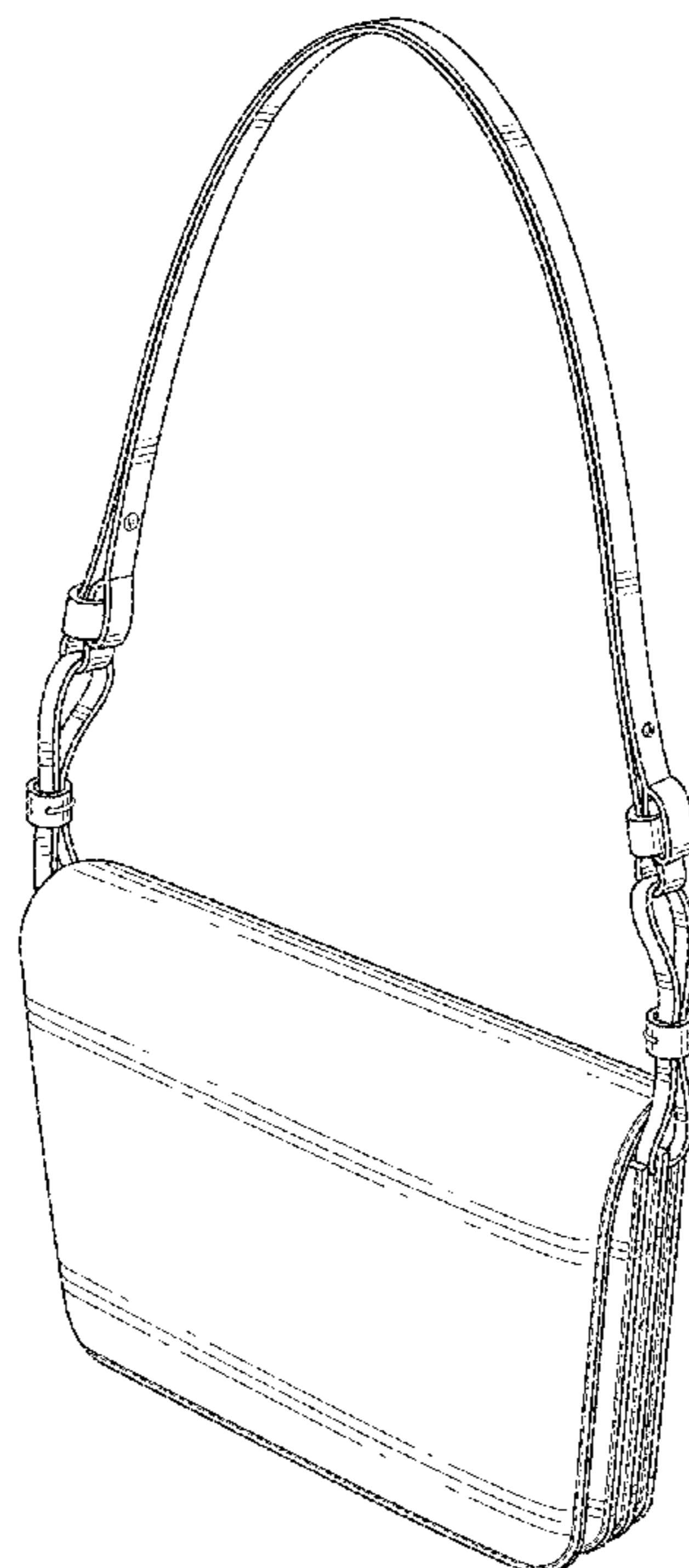

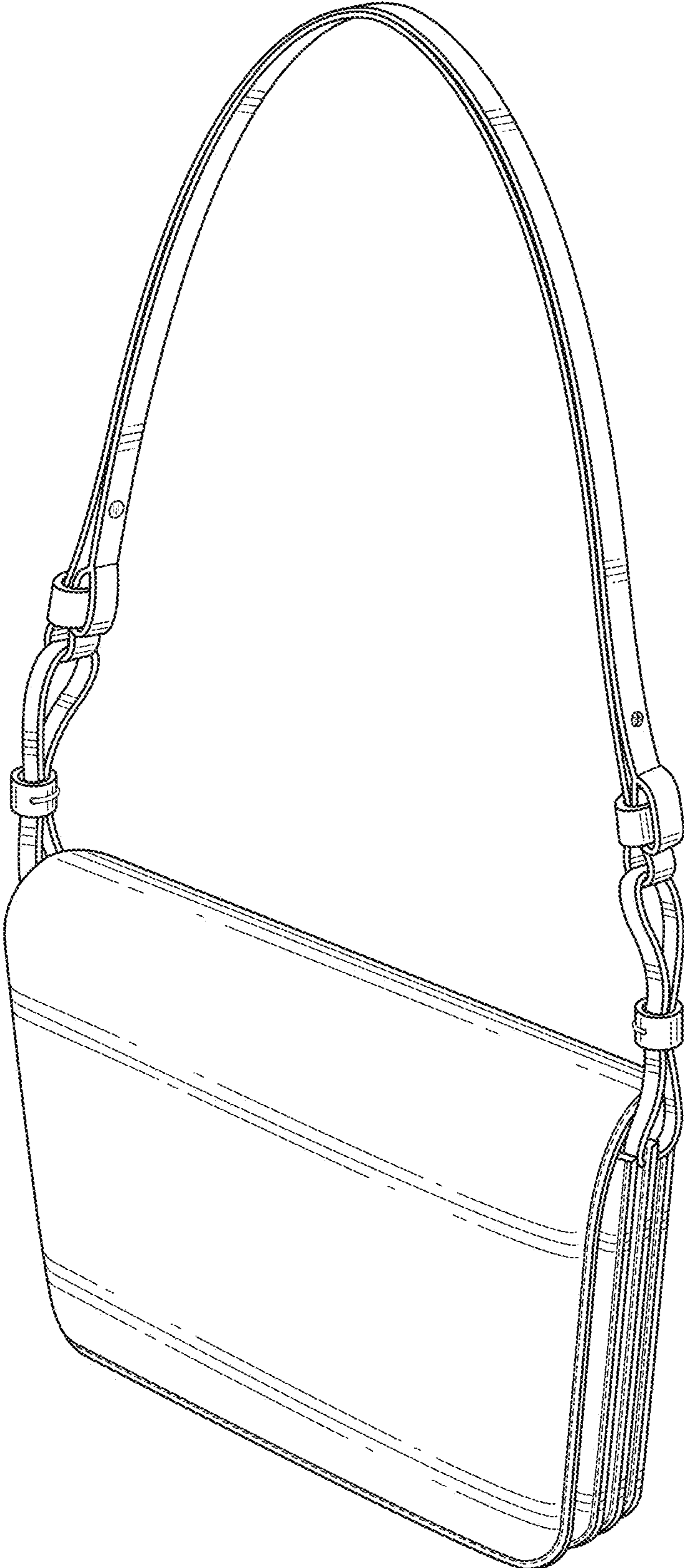

FIG. 1

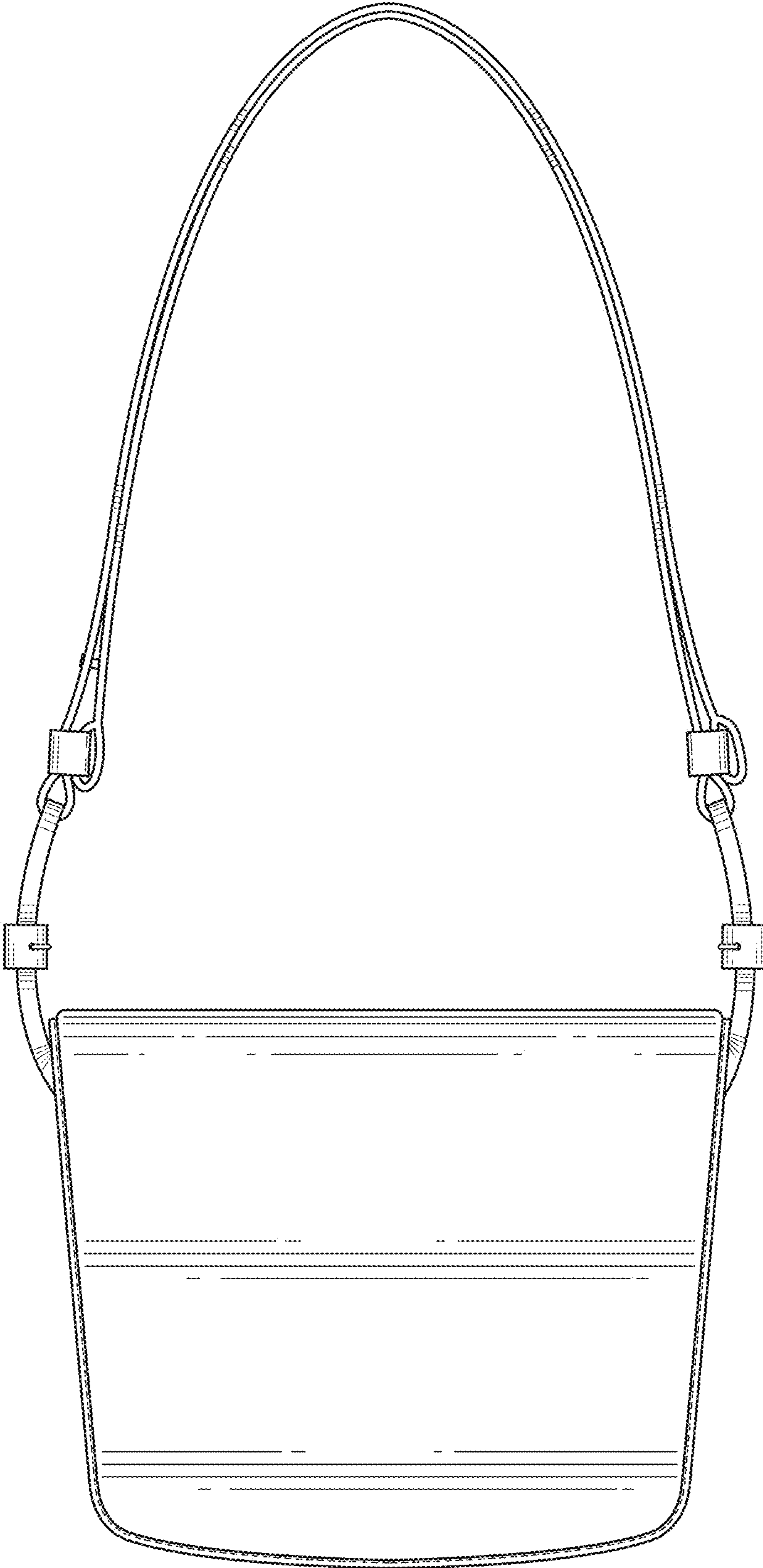

FIG. 2

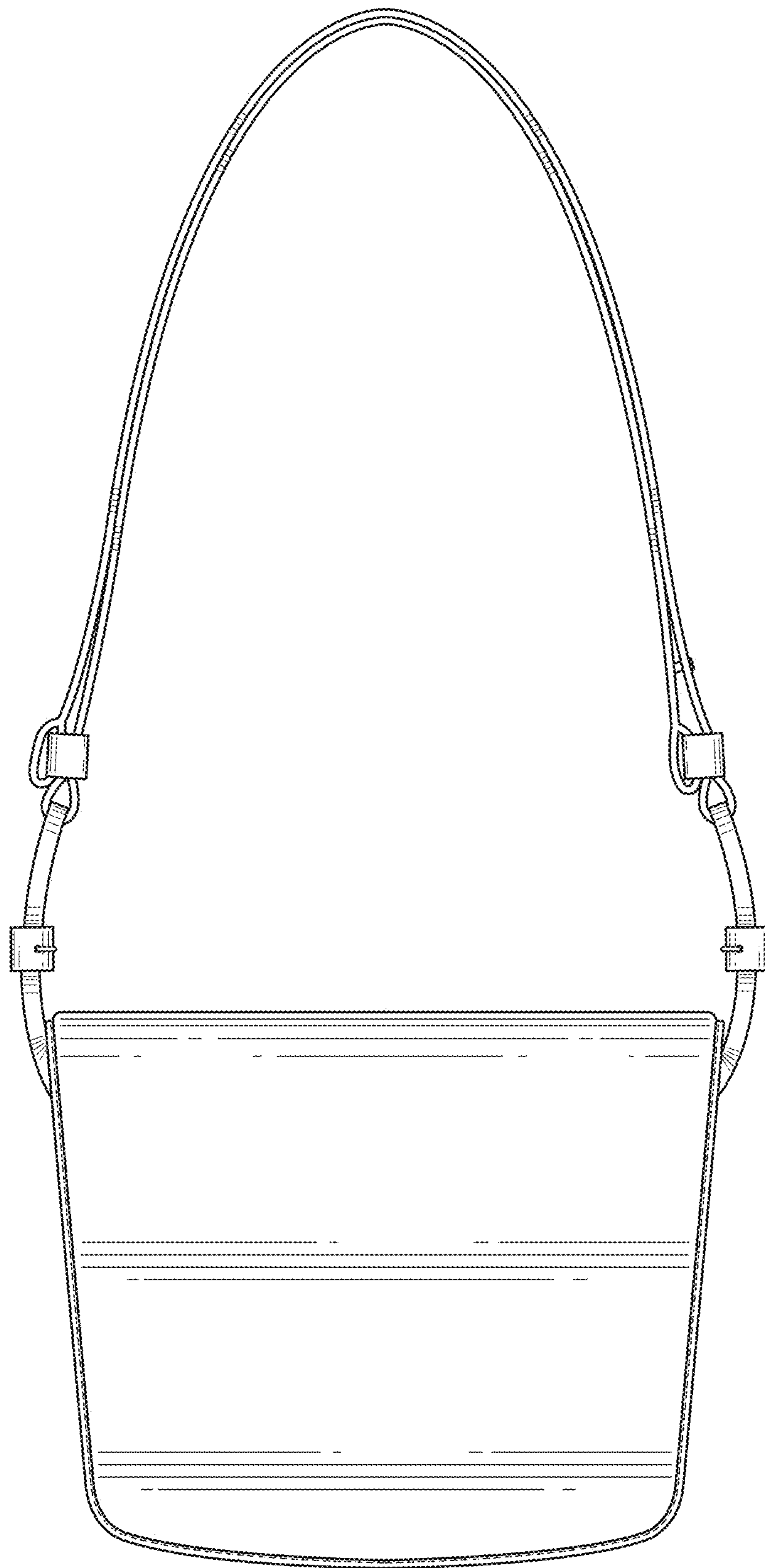

FIG. 3

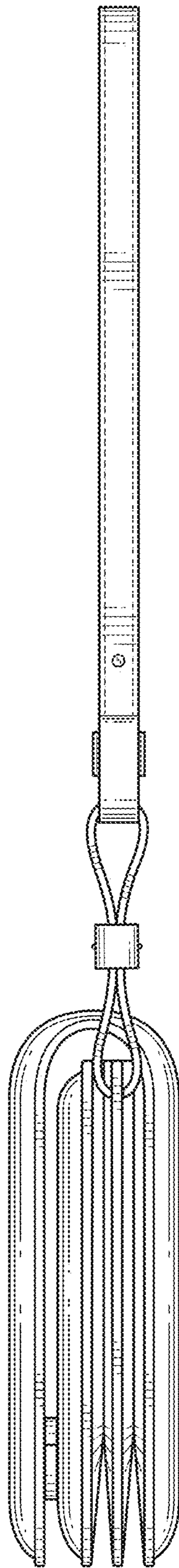

FIG. 4

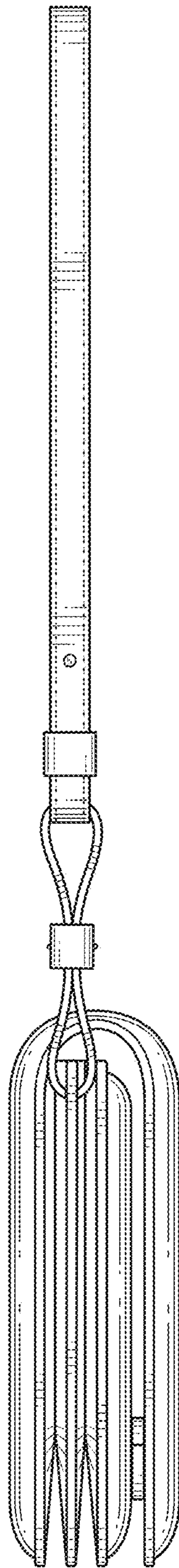

FIG. 5

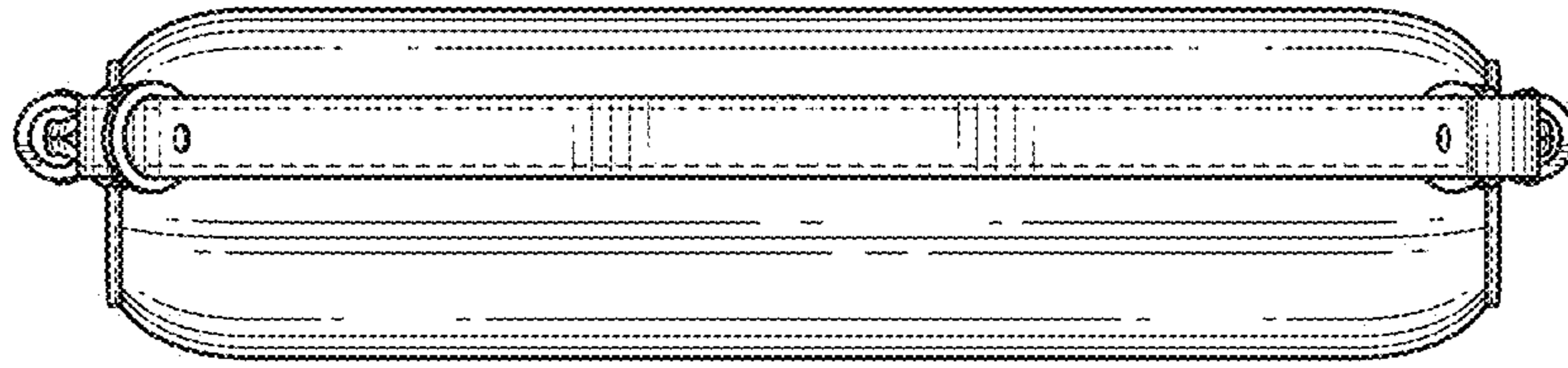

FIG. 6

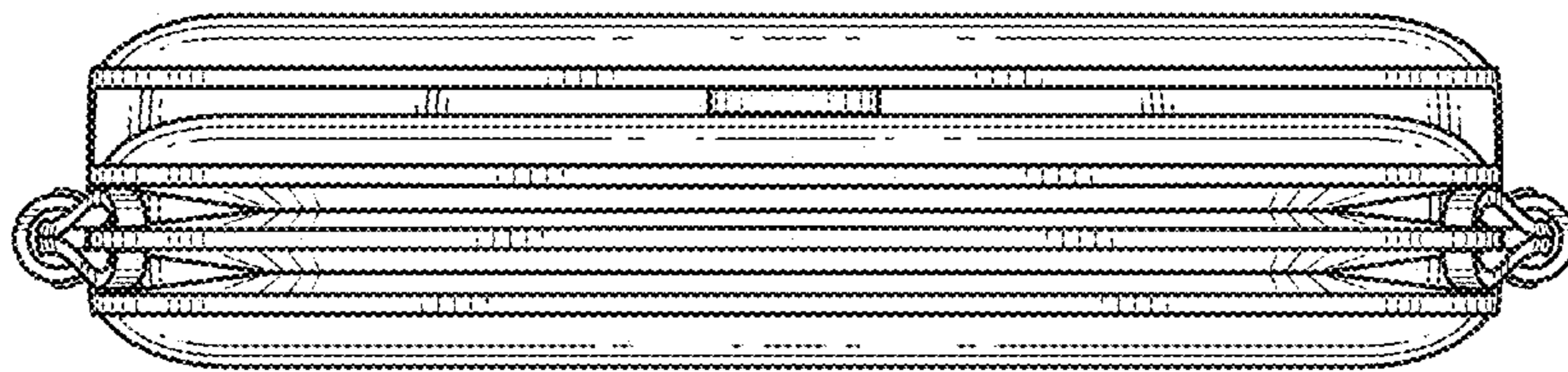

FIG. 7

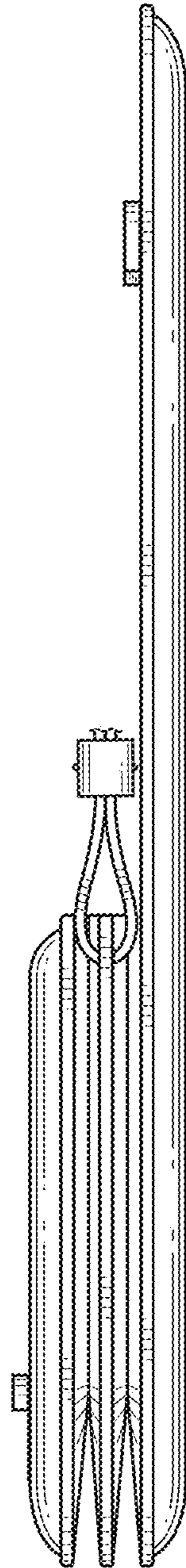

FIG. 8

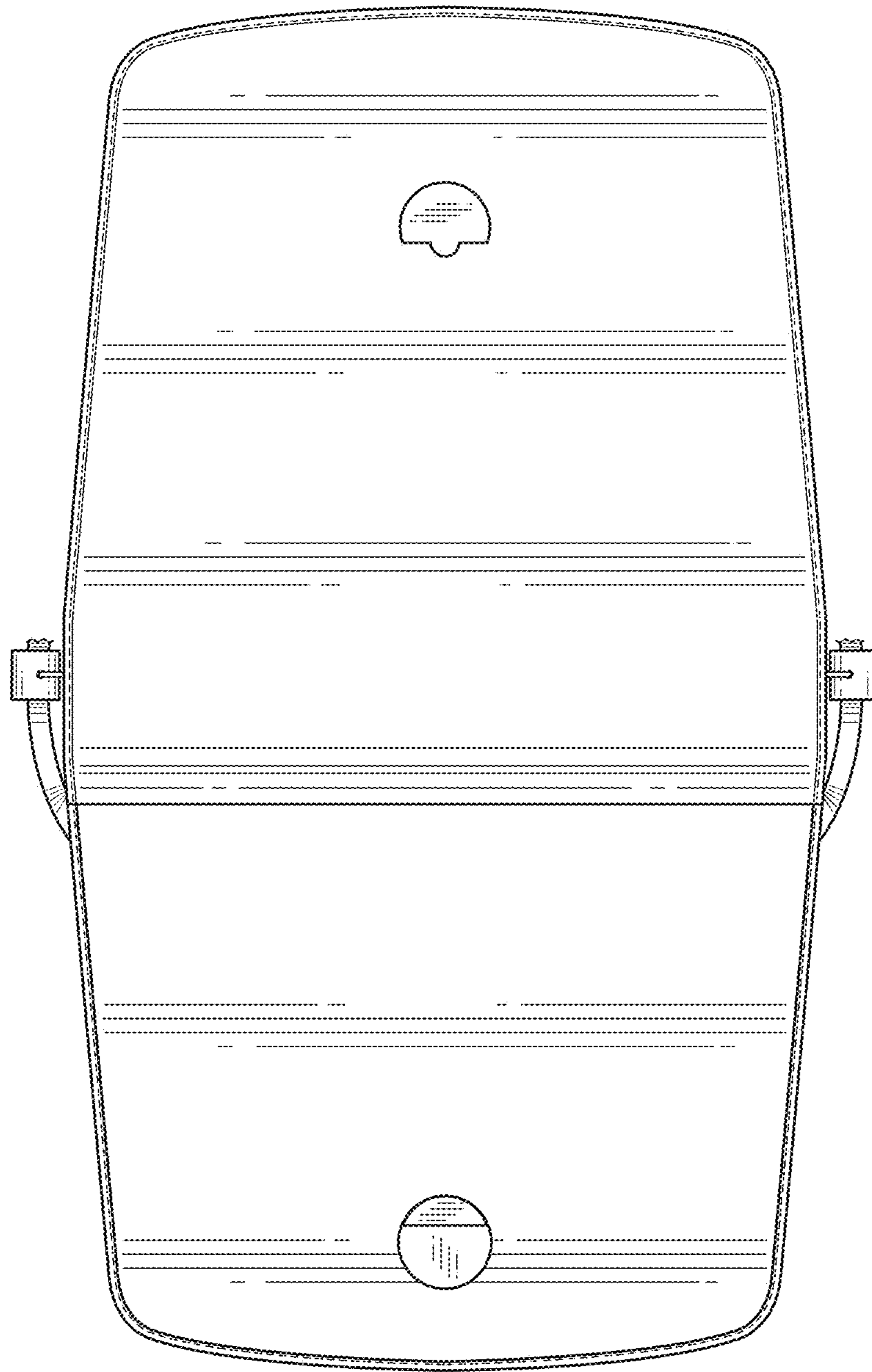

FIG. 9

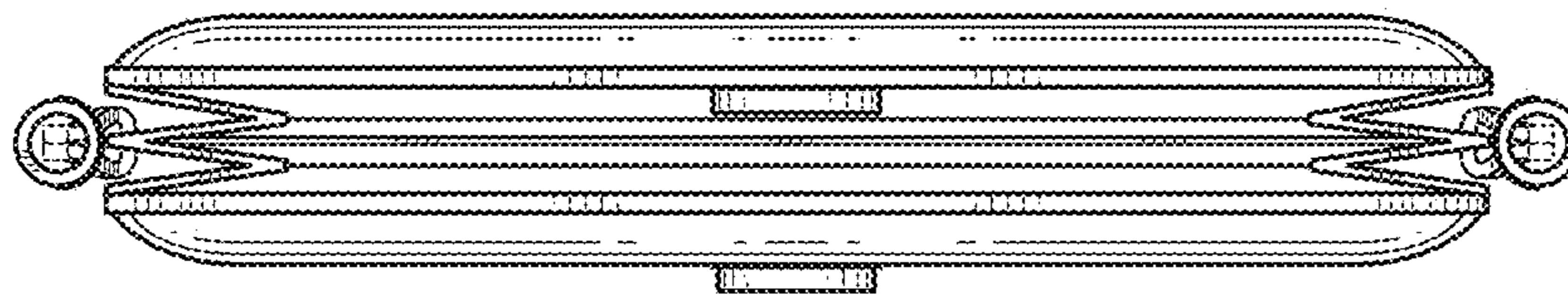

FIG. 10

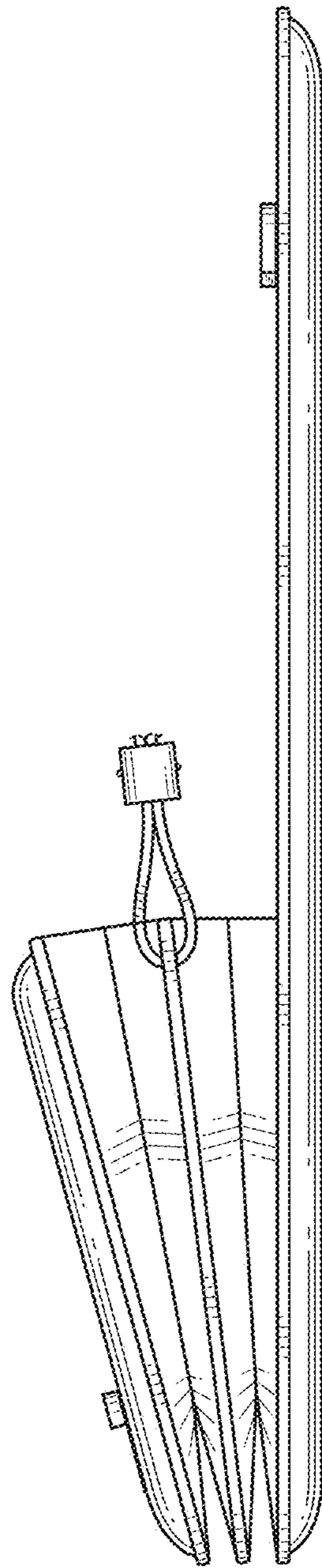

FIG. 11

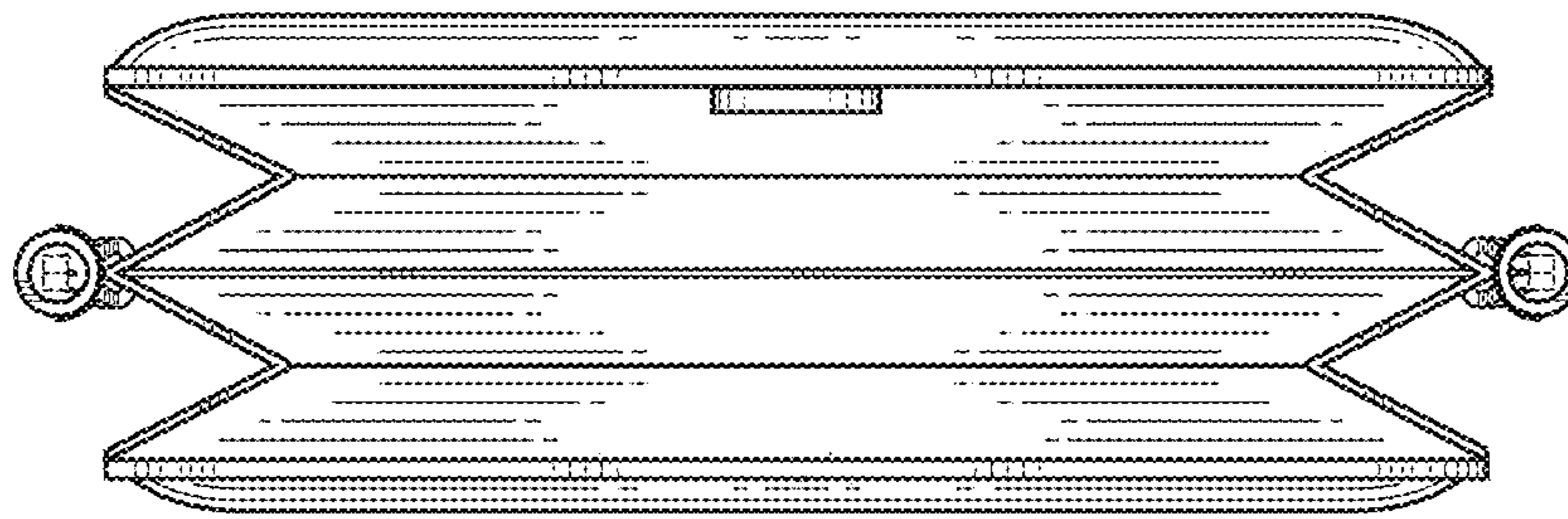

FIG. 12

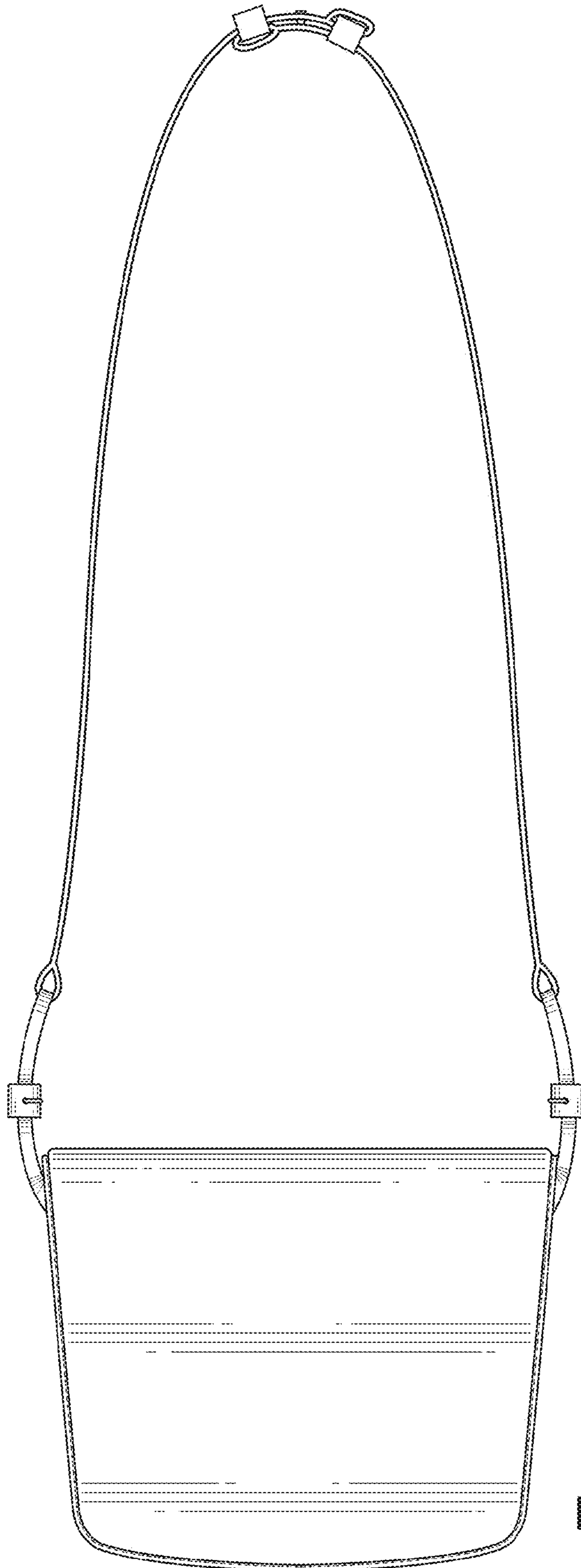

FIG. 13