



US00D884228S

(12) **United States Design Patent**
He

(10) **Patent No.:** **US D884,228 S**

(45) **Date of Patent:** **** May 12, 2020**

(54) **EXTERIOR SURFACE CONFIGURATION OF
A HEADLIGHT FOR A VEHICLE**

D561,358 S * 2/2008 Tachibana D26/28
D570,007 S * 5/2008 Hsu D26/28
D694,443 S * 11/2013 Mackay D26/28

(71) Applicant: **Arex Industries, Inc.**, Irwindale, CA
(US)

* cited by examiner

(72) Inventor: **Mizeng He**, TaiZhou (CN)

Primary Examiner — Marcus A Jackson

(**) Term: **15 Years**

(74) *Attorney, Agent, or Firm* — Theodore S. Lee, Esq.

(21) Appl. No.: **29/681,589**

(22) Filed: **Feb. 27, 2019**

(51) **LOC (12) Cl.** **26-06**

(52) **U.S. Cl.**
USPC **D26/28**

(58) **Field of Classification Search**
USPC D26/28–36, 139
CPC F21S 48/00; F21S 48/10; F21S 48/115;
F21S 48/225; F21S 48/1233; F21S
48/1266; F21S 48/1388; F21S 48/2268;
F21V 21/04; F21V 29/004; B60Q 9/13;
B60Q 9/135; B60Q 9/1375
See application file for complete search history.

(57) **CLAIM**

The ornamental design for an exterior surface configuration of a headlight for a vehicle, as shown and described.

DESCRIPTION

FIG. 1 is a perspective view of an exterior surface configuration of a headlight for a vehicle according to the novel design;

FIG. 2 is left side view thereof;

FIG. 3 is a front view thereof;

FIG. 4 is a right side view thereof;

FIG. 5 is a back side view thereof;

FIG. 6 is an alternative perspective view thereof; and,

FIG. 7 is a top view thereof.

The broken lines are for environmental purposes only and form no part of the claimed design. The design shown is not to be limited to any particular size and may be scaled larger or smaller. The drawings and descriptions represent the right side embodiment. The claim is also for a mirror image of a left side embodiment that is not shown.

(56) **References Cited**

U.S. PATENT DOCUMENTS

D538,956 S * 3/2007 Ishii D26/28
D544,614 S * 6/2007 Markefka D26/28

1 Claim, 7 Drawing Sheets

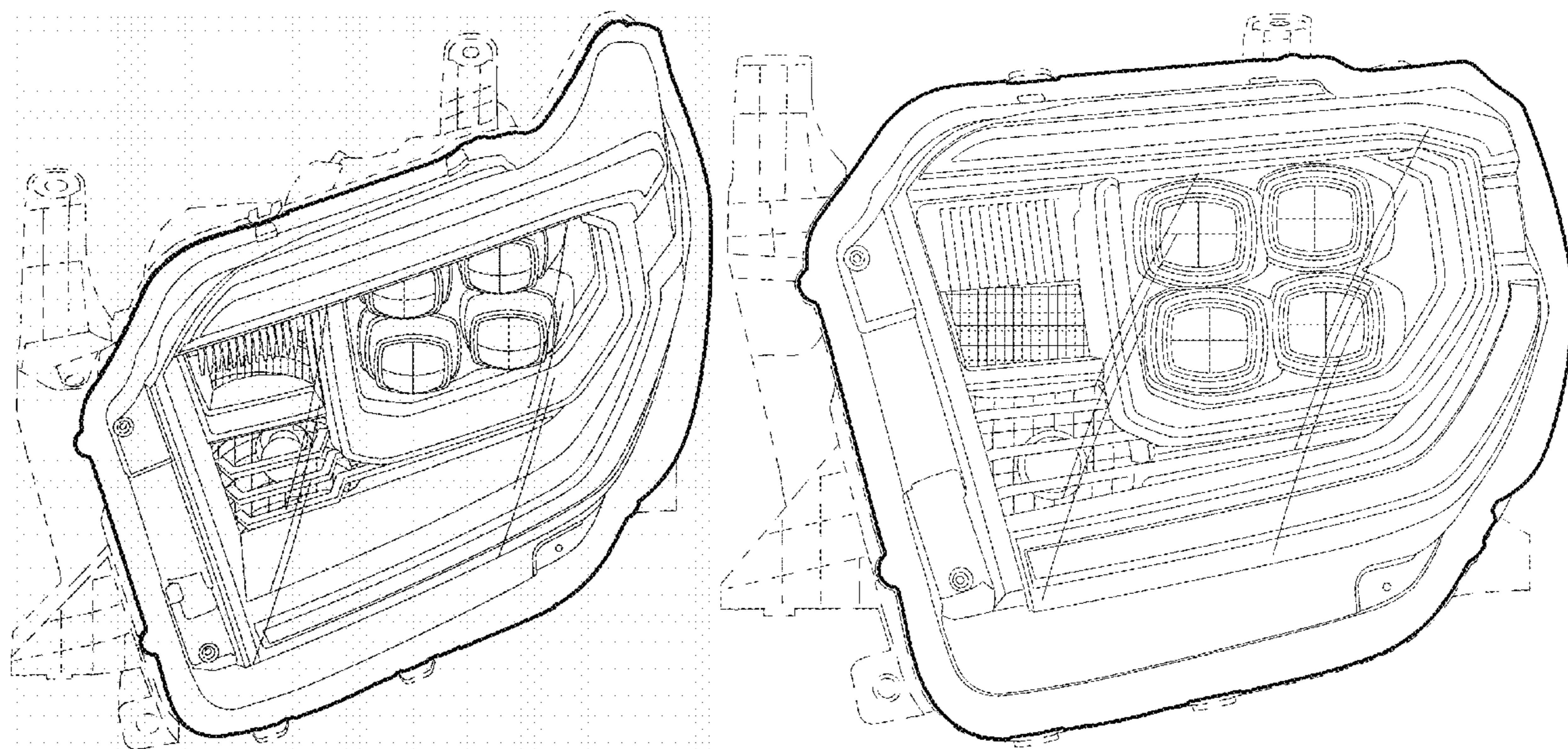

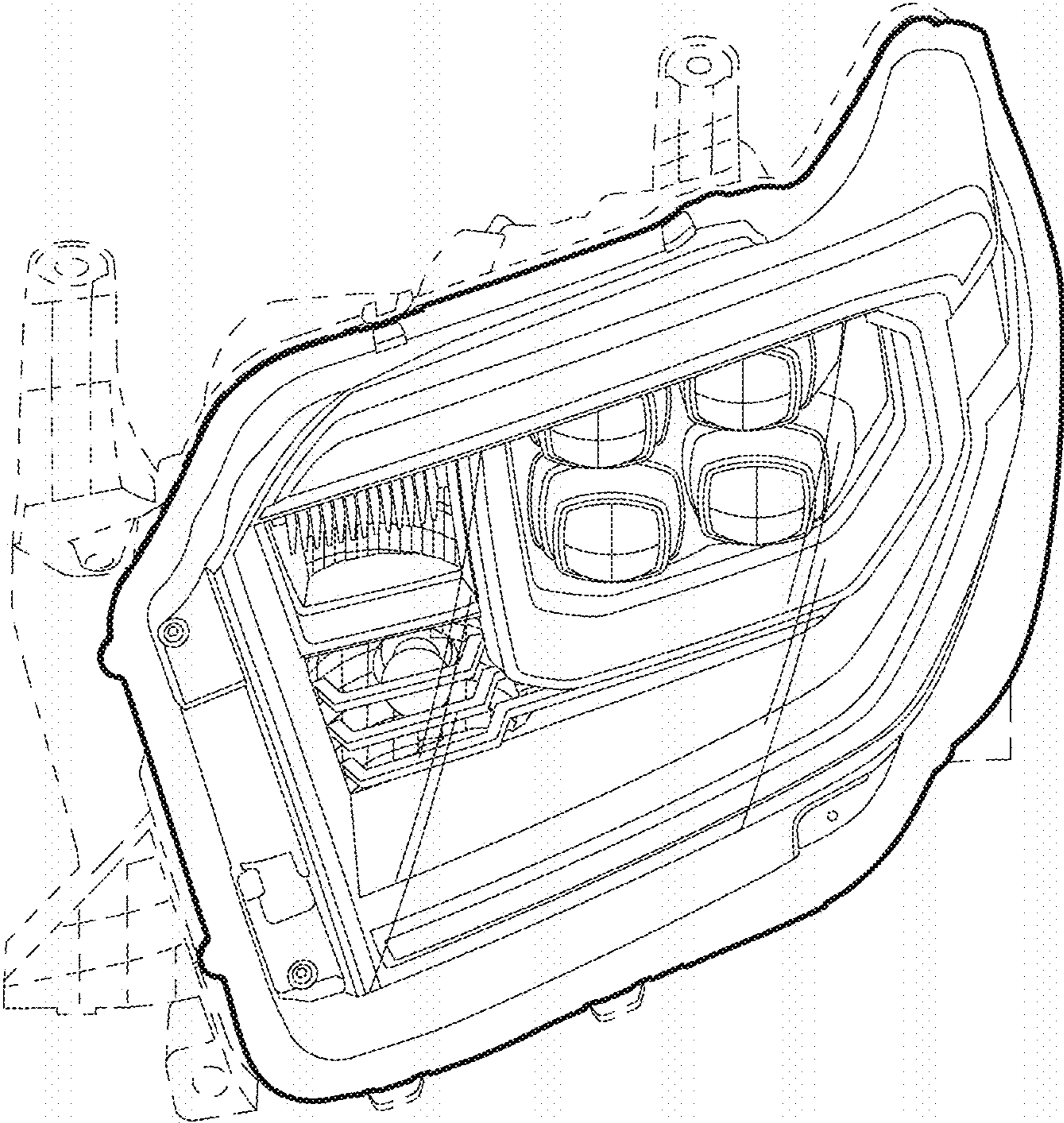

FIG. 1

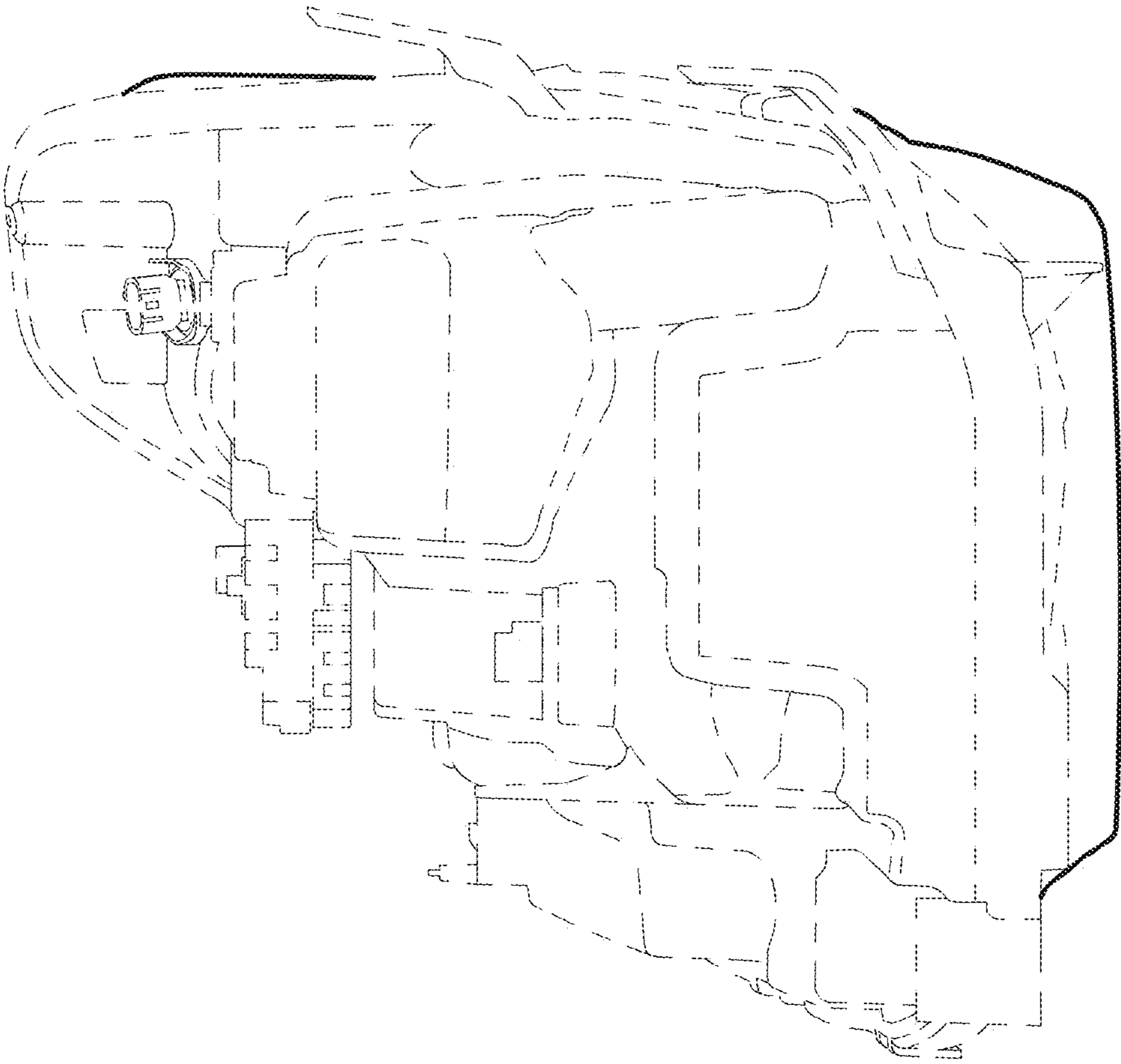

FIG. 2

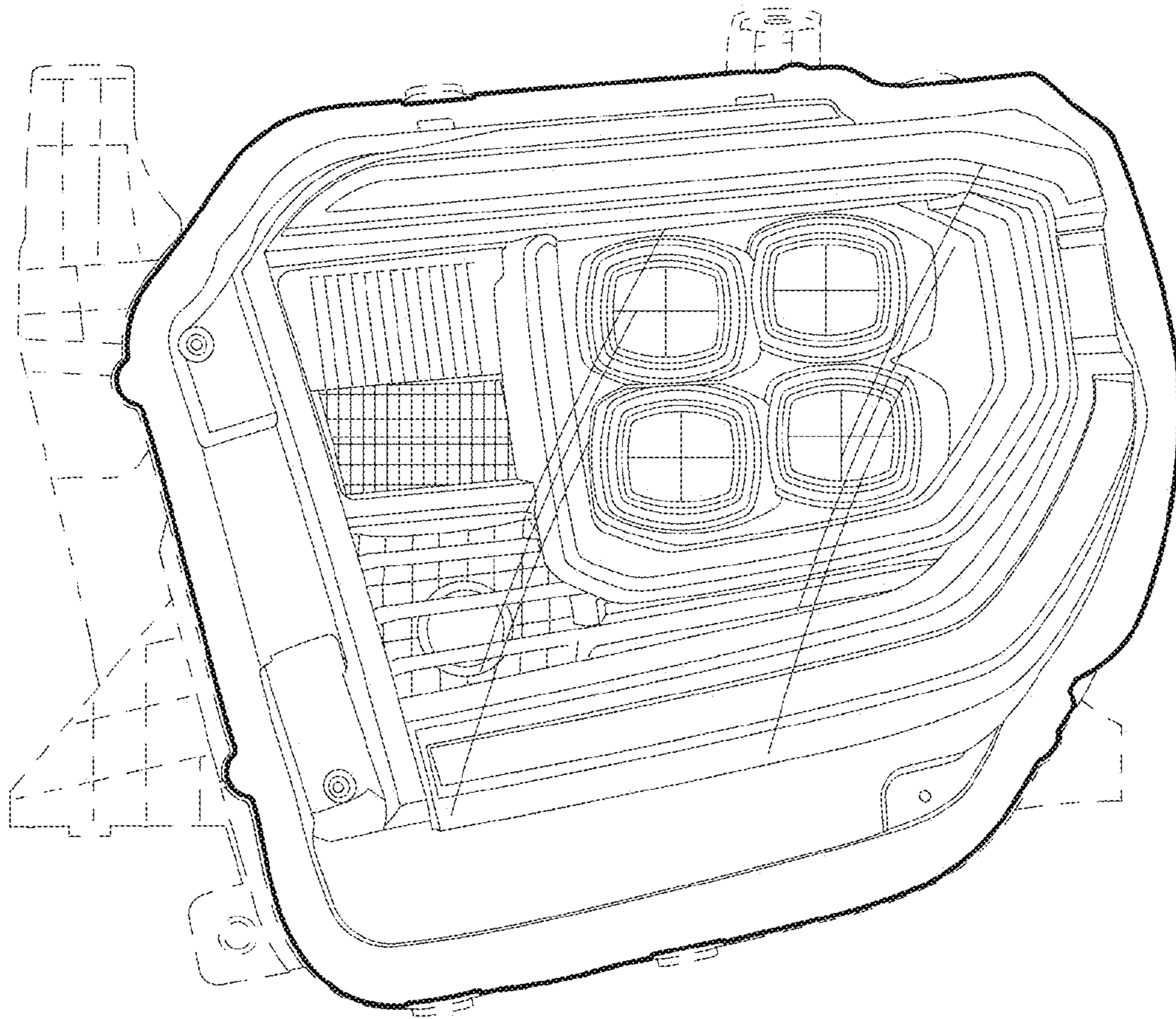

FIG. 3

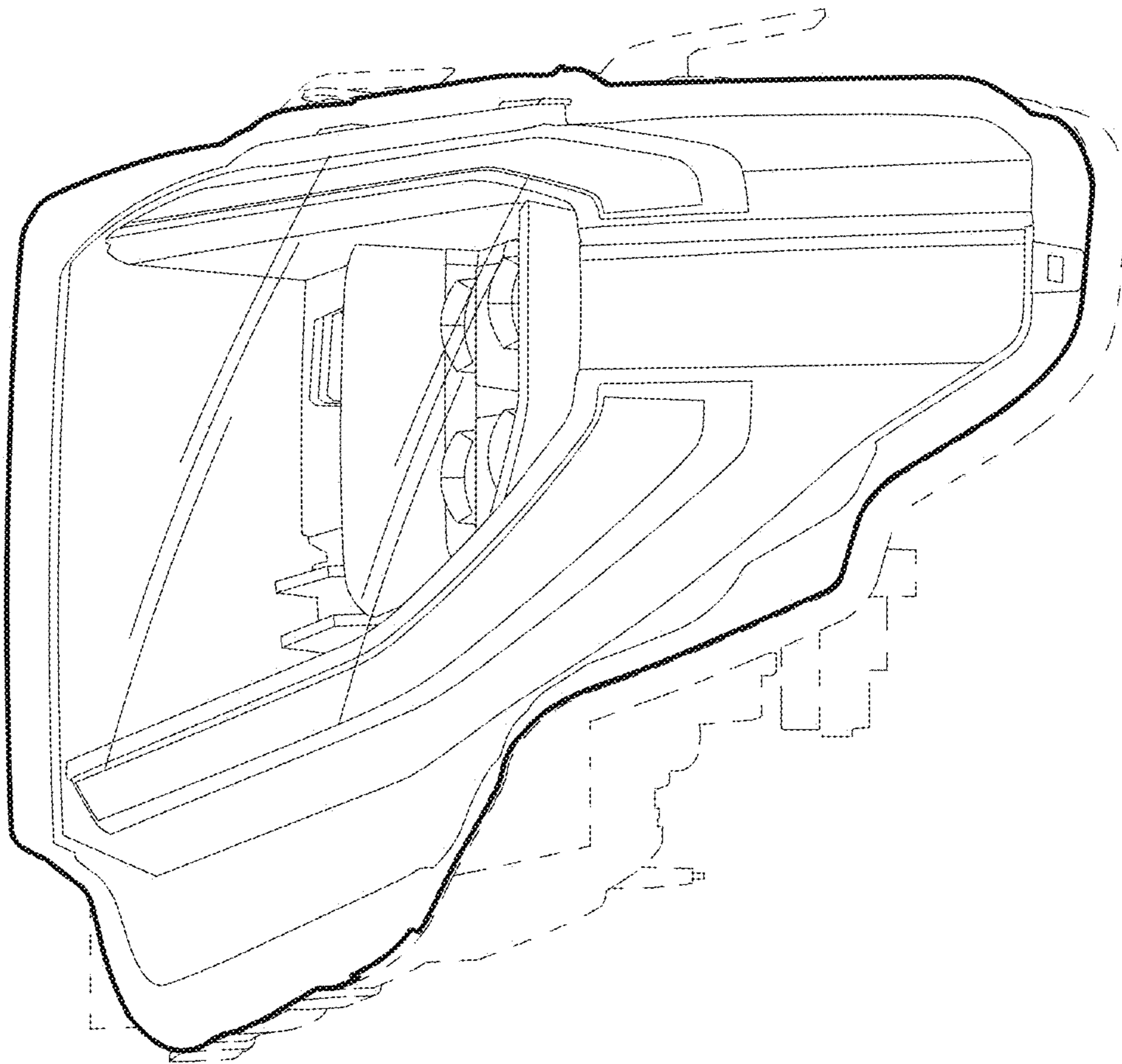

FIG. 4

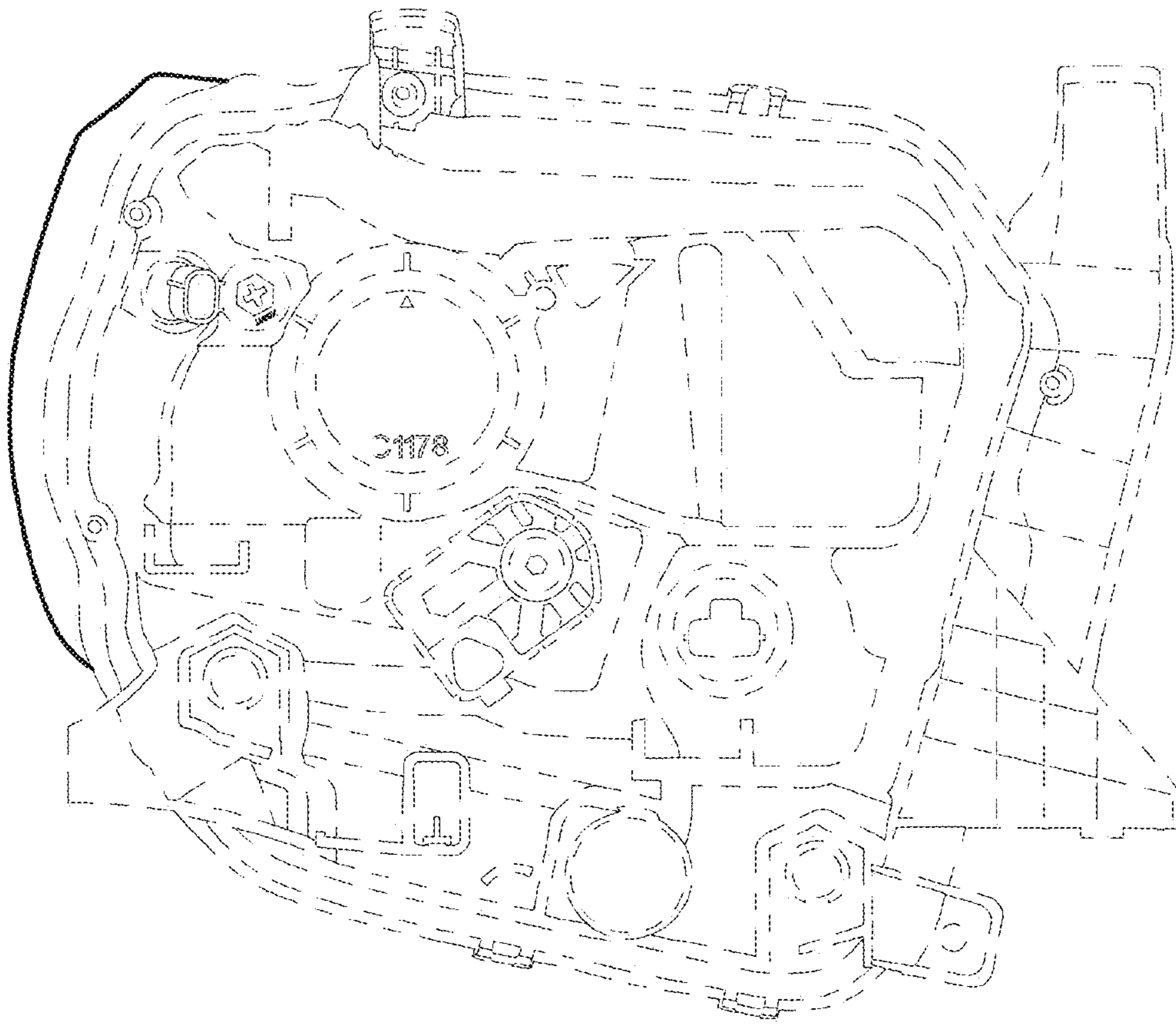

FIG. 5

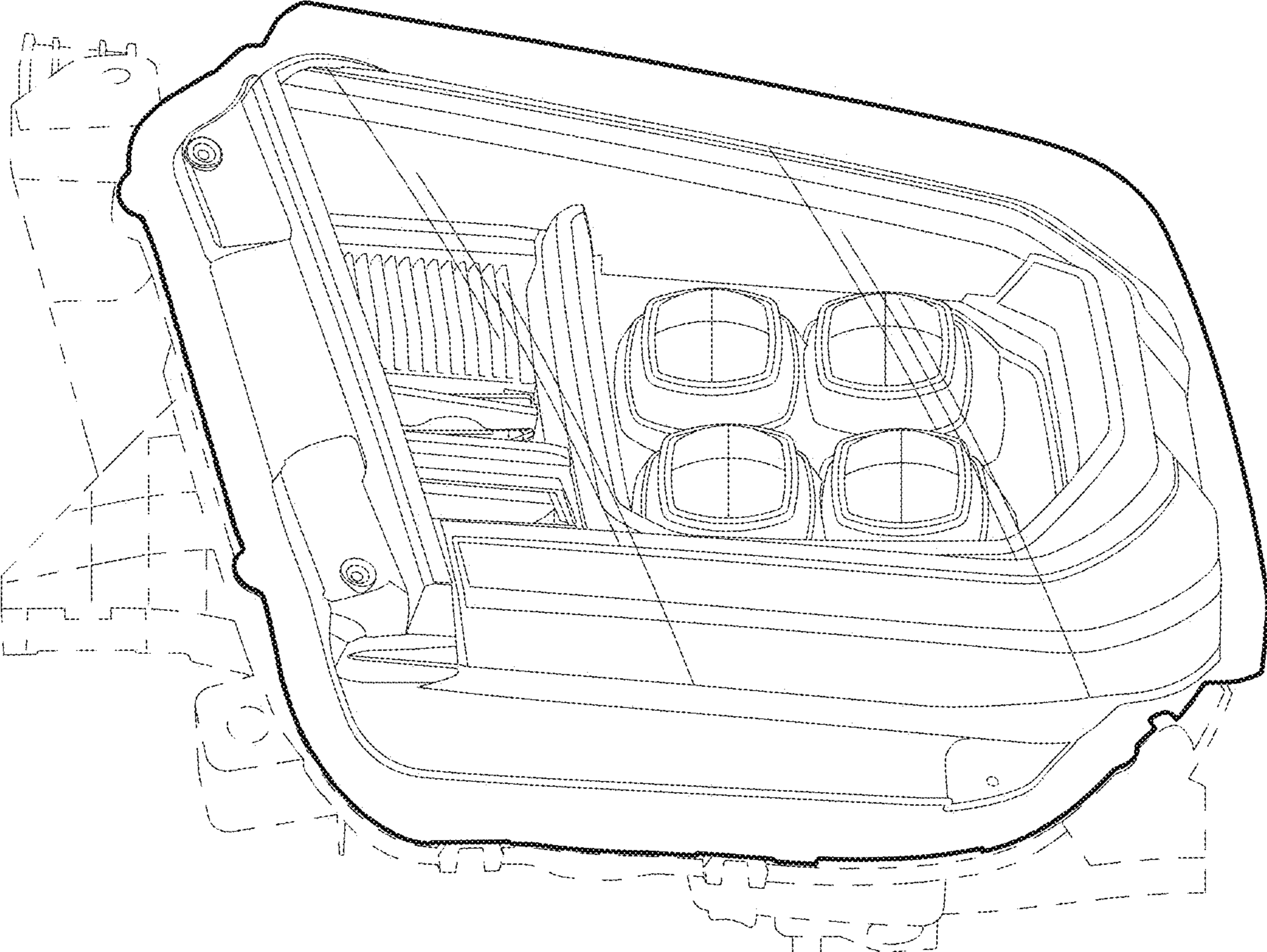

FIG. 6

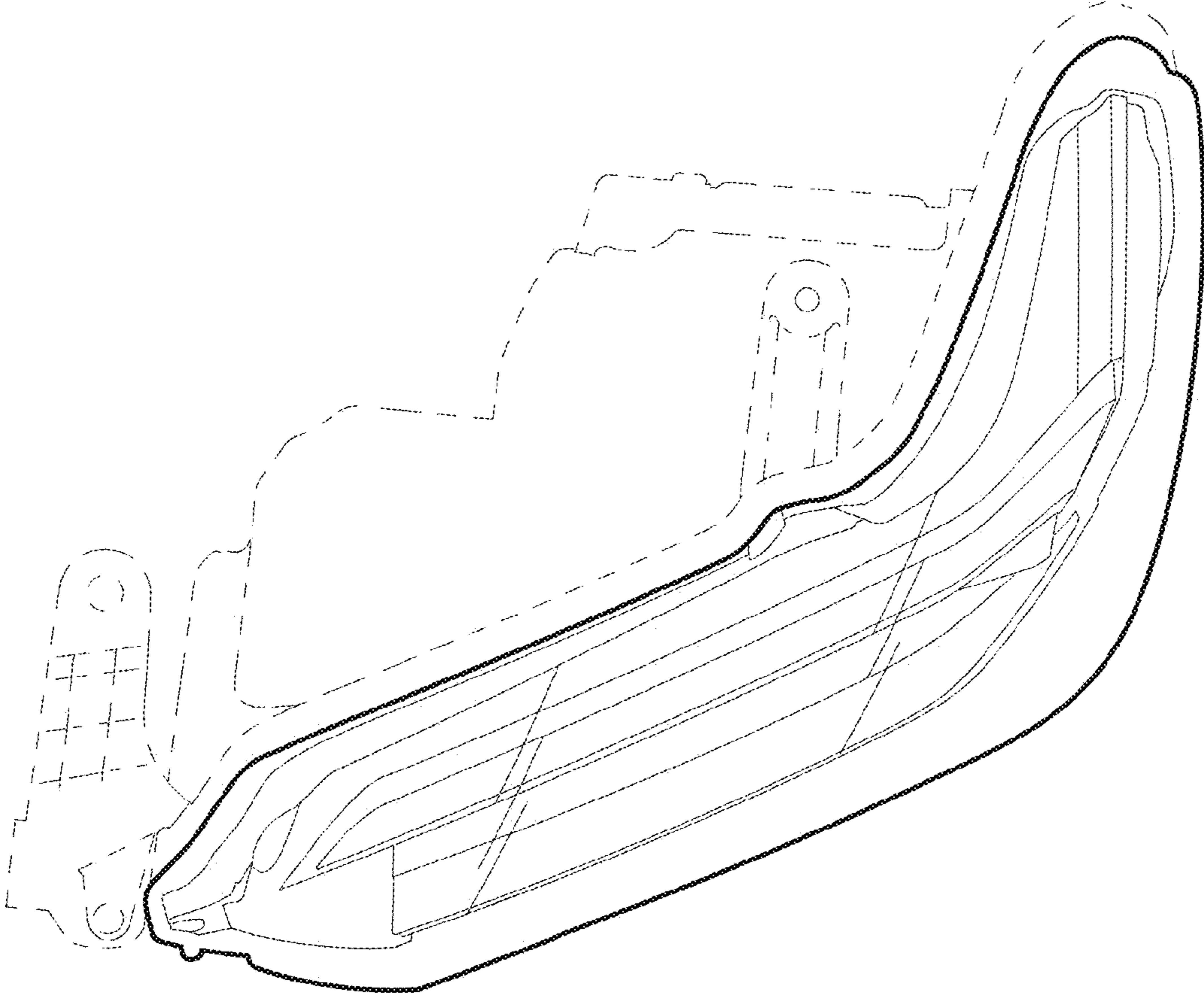

FIG. 7