



US00D884162S

(12) **United States Design Patent** (10) **Patent No.:** **US D884,162 S**
Haddad et al. (45) **Date of Patent:** **** May 12, 2020**

(54) **INTRAVENOUS TUBING INDICATOR FOR A NARCOTIC**

(71) Applicant: **Star Luminal LLC**, San Antonio, TX (US)

(72) Inventors: **Eric A. Haddad**, Boerne, TX (US);
Bryce G. Rutter, St. Louis, MO (US);
Tucker P. Brown, St. Louis, MO (US)

(73) Assignee: **STAR LUMINAL LLC**, San Antonio, TX (US)

(**) Term: **15 Years**

(21) Appl. No.: **29/666,813**

(22) Filed: **Oct. 16, 2018**

(51) **LOC (12) Cl.** **24-01**

(52) **U.S. Cl.**

USPC **D24/127; D20/28**

(58) **Field of Classification Search**

USPC D24/127-131, 112-114, 133, 186;
606/181, 185; 604/264, 523-528, 272,
604/187, 158, 164.01-164.11, 181, 184,
604/227; 600/101, 139, 143;
128/200.24, 207.14, 207.15; D8/396,
D8/356; D6/300, 674; D12/193;
D14/489, 490, 492, 495; D20/1-44, 99
CPC A61M 25/00; A61M 39/00; A61M 27/00;
A61M 25/0043; A61M 5/0067; A61M
25/0097; A61M 5/14; A61M 5/1411;
A61M 2205/60; A61M 2205/6063; A61M
2205/6072; A61M 2205/6081; A61F
2/958; A62C 13/78; A47K 10/14; A47G
25/0657

See application file for complete search history.

(56) **References Cited**

U.S. PATENT DOCUMENTS

D386,211 S * 11/1997 Taparauskas, Jr. D20/22
D420,610 S * 2/2000 Pinchuk D10/104.1

6,613,012 B2 9/2003 Kraushaar
D556,606 S * 12/2007 Stauffer D10/15
7,338,476 B2 3/2008 Kraushaar
7,374,318 B2 5/2008 Brooks et al.
7,455,662 B2 11/2008 Kraushaar
D636,819 S * 4/2011 Walker D20/28
D638,664 S * 5/2011 Mayer D7/624.1
D657,425 S * 4/2012 Podd D20/42
D660,367 S * 5/2012 Podd D20/42
D665,030 S * 8/2012 Podd D20/42
D791,242 S * 7/2017 Lemberger D20/41
D791,878 S * 7/2017 Loew D20/41
D803,943 S * 11/2017 Loew D20/41
9,833,560 B2 12/2017 Reichert et al.
9,919,095 B2 3/2018 Reichert et al.

(Continued)

Primary Examiner — Nathan M Johnston

(74) *Attorney, Agent, or Firm* — Joseph Agostino;
Greenberg Traurig, LLP

(57) **CLAIM**

The ornamental design for an intravenous tubing indicator for a narcotic, as shown and described.

DESCRIPTION

FIG. 1 is a top perspective view of an intravenous tubing indicator for a narcotic showing our new design; FIG. 2 is a front elevation view thereof; FIG. 3 is a rear elevation view thereof; FIG. 4 is a right side elevation view thereof; FIG. 5 is a left side elevation view thereof; FIG. 6 is top plan view thereof; and, FIG. 7 is a bottom plan view thereof. The dashed lines immediately adjacent the shaded areas in the figures represent the boundaries of the claimed design. The dashed lines in the figures illustrate the portions of the design that form no part of the claimed design. None of the broken lines form any part of the claimed design.

1 Claim, 5 Drawing Sheets

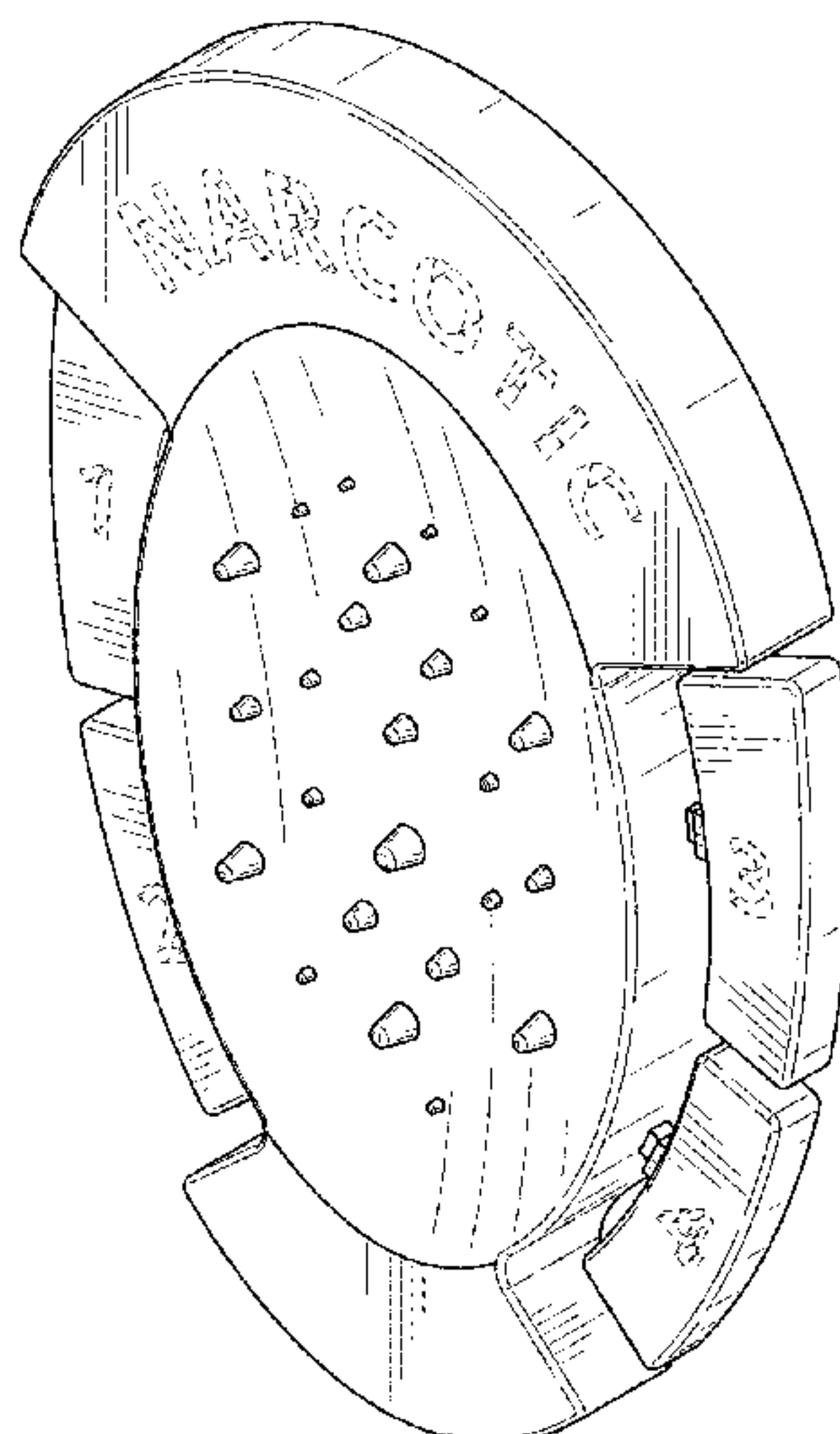

(56)

References Cited

U.S. PATENT DOCUMENTS

9,925,329	B2	3/2018	Reichert et al.	
D842,382	S *	3/2019	Loew	D20/41
D849,053	S *	5/2019	Niven	D14/492
2002/0058928	A1	5/2002	Antonio, II	
2005/0171492	A1	8/2005	Rodriquez	

* cited by examiner

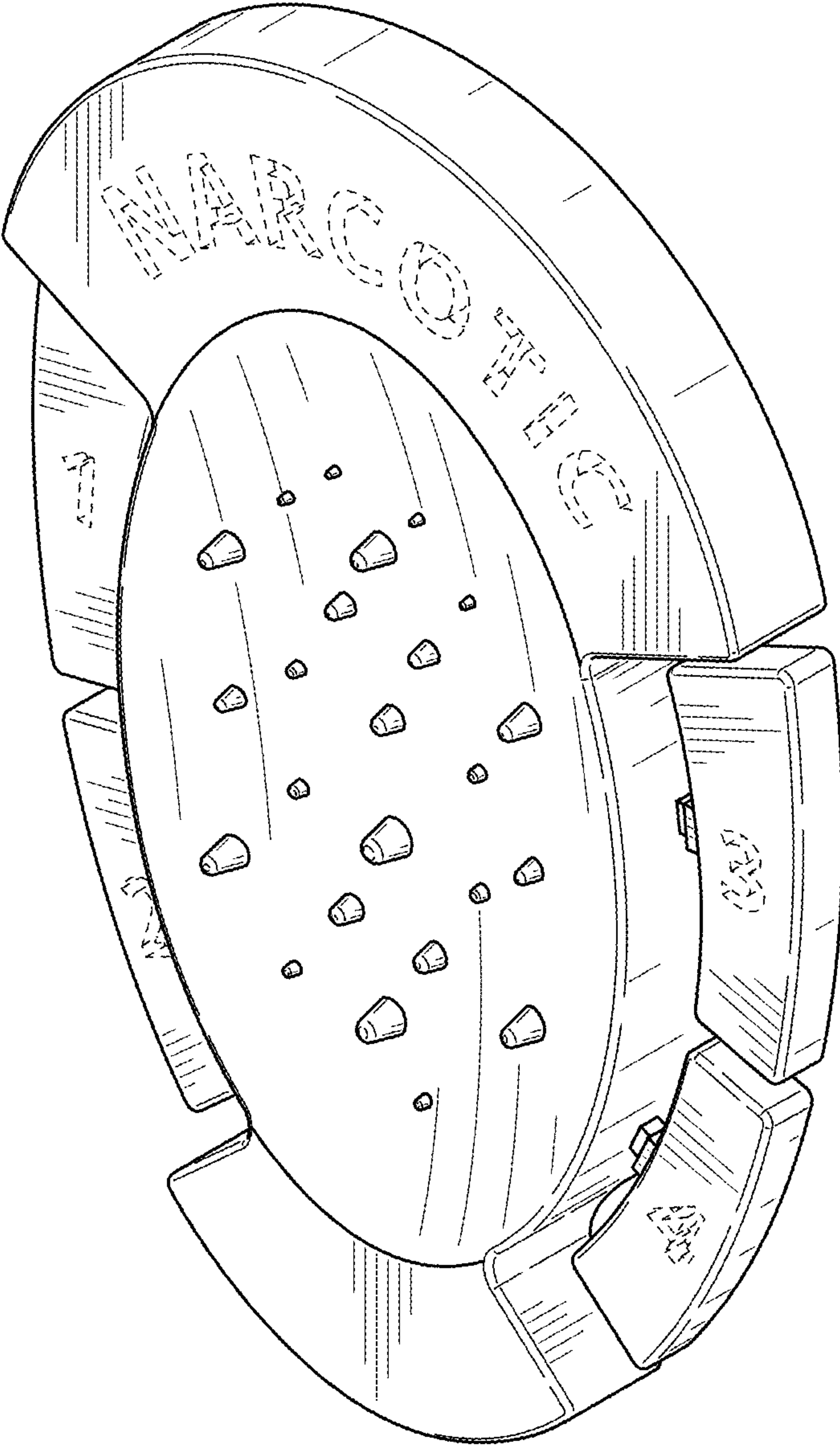

FIG. 1

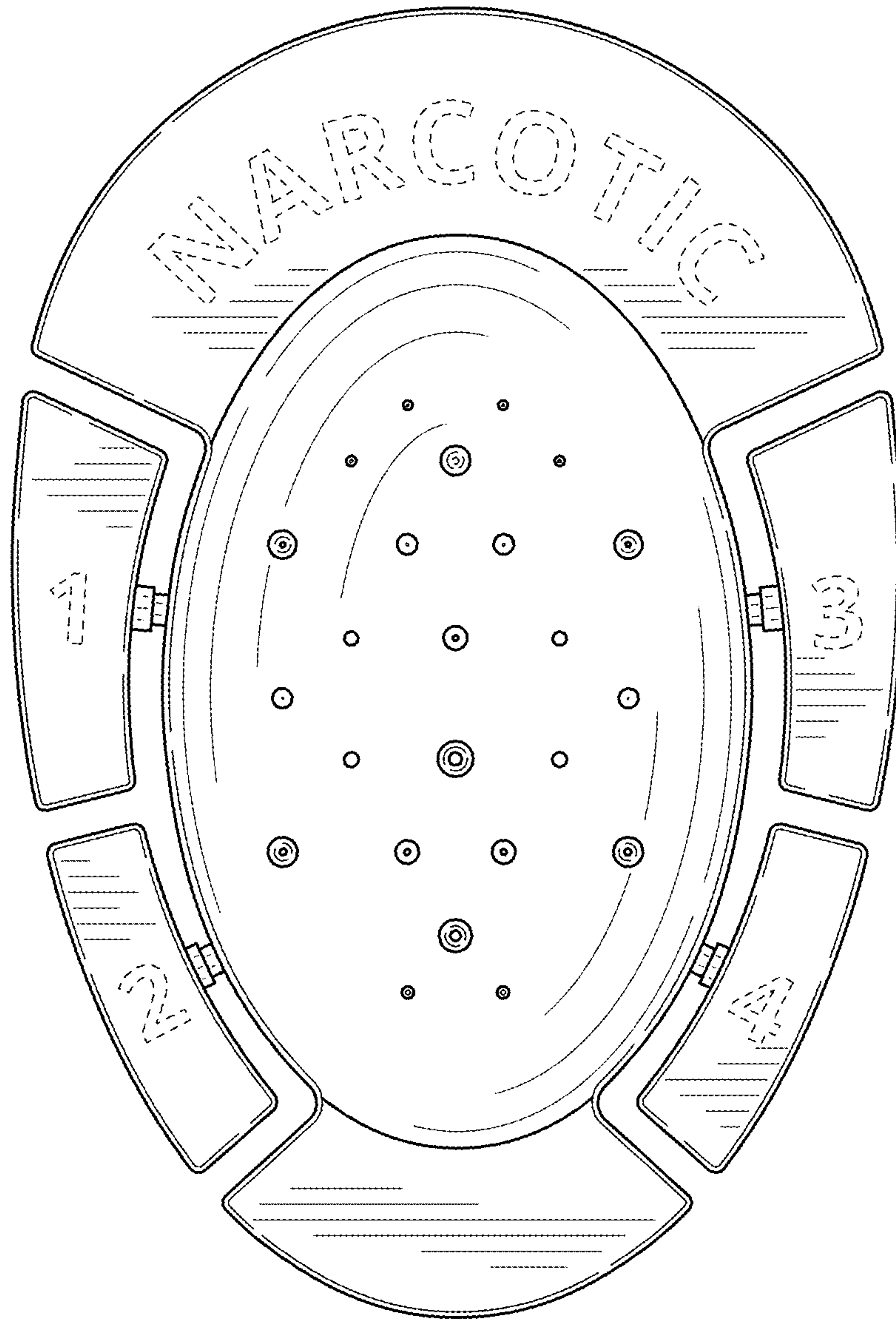

FIG. 2

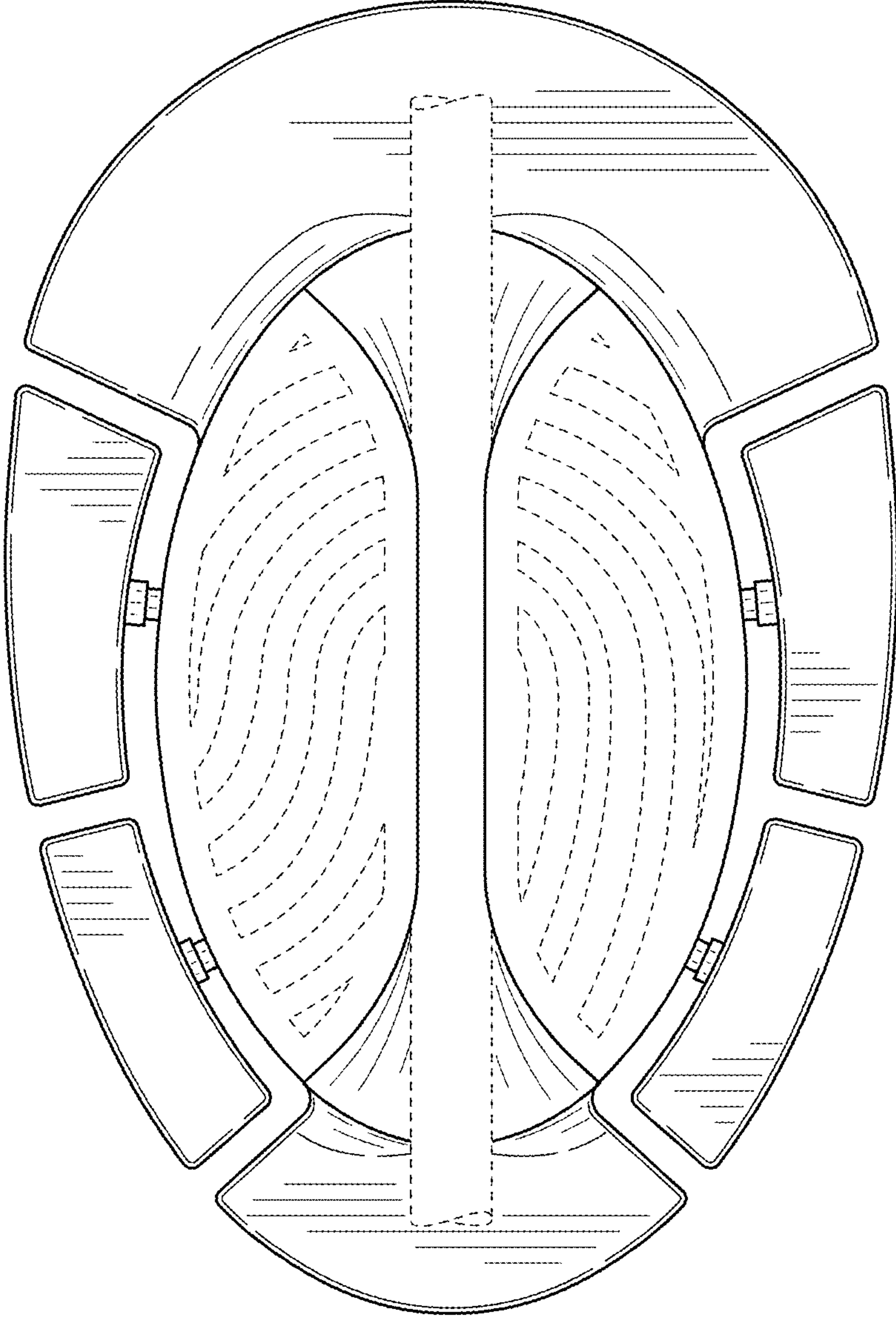

FIG. 3

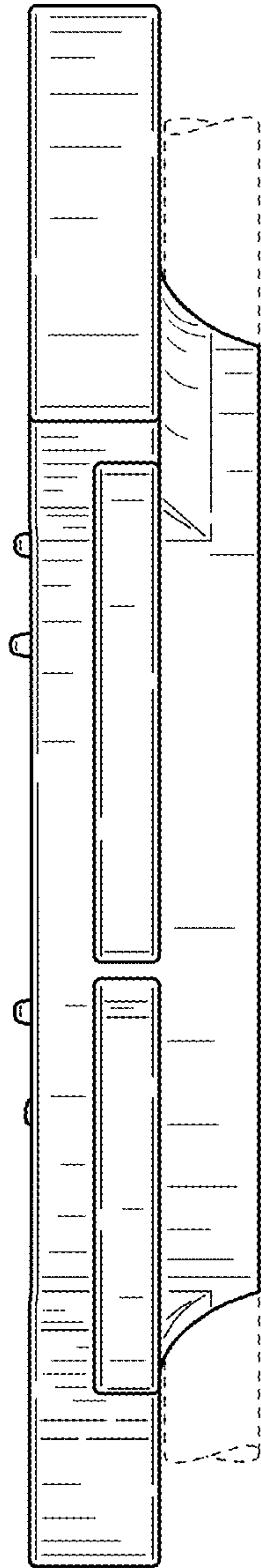

FIG. 4

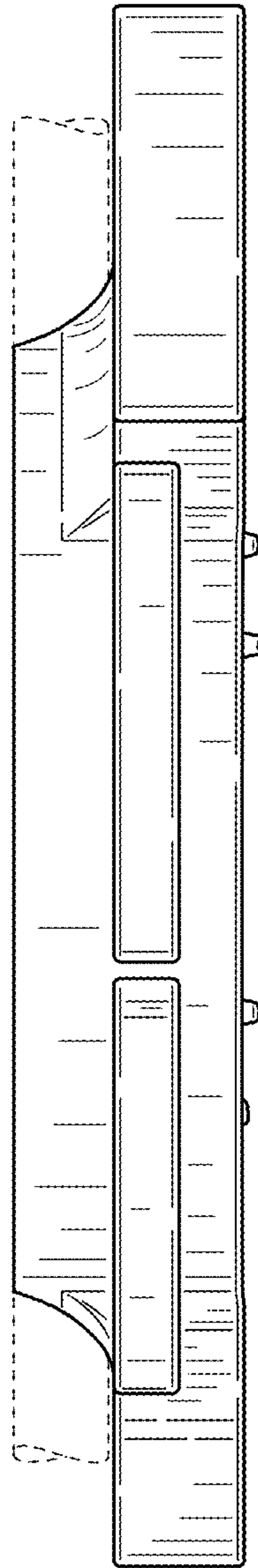

FIG. 5

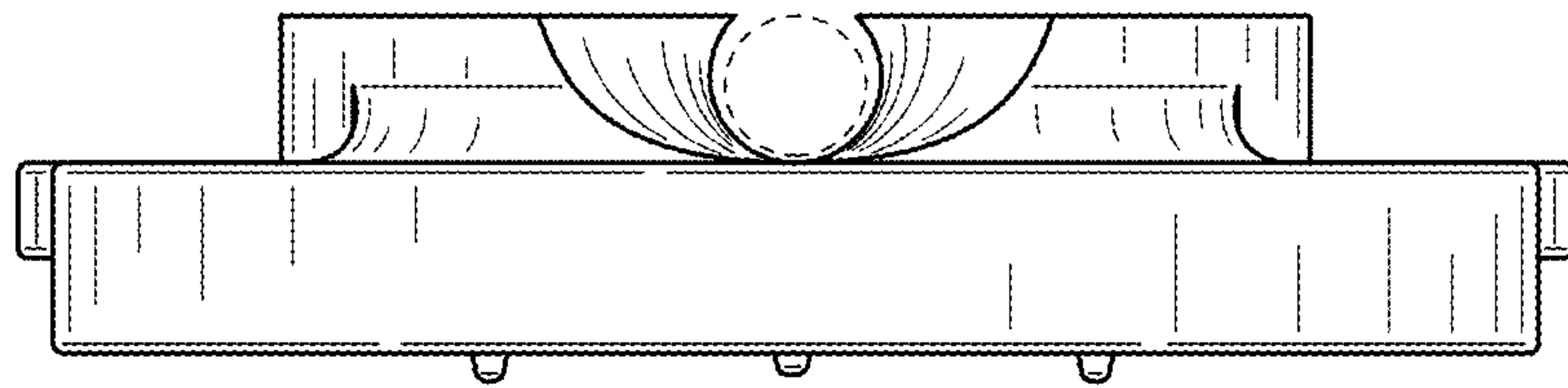

FIG. 6

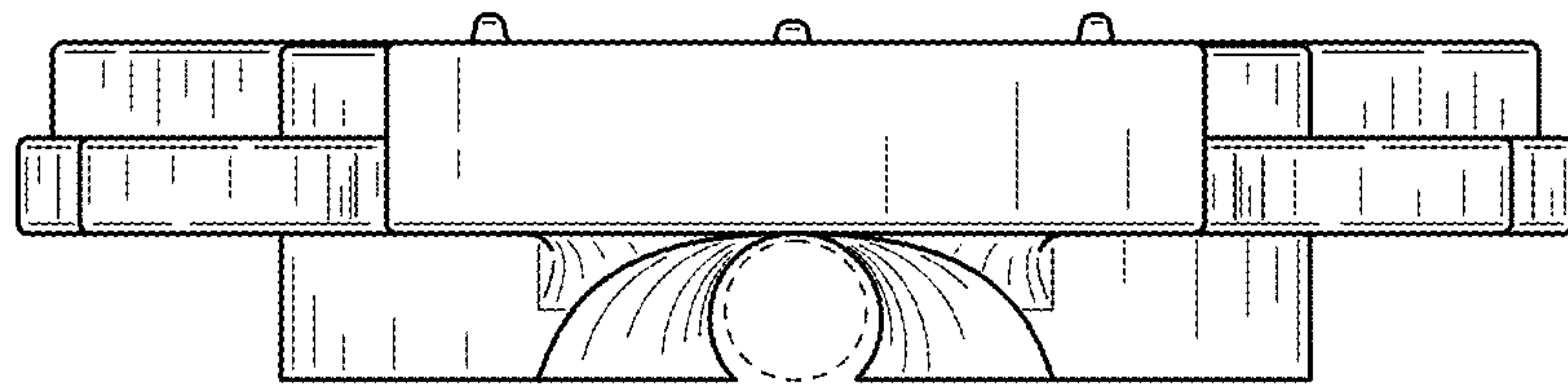

FIG. 7