



US00D883958S

(12) **United States Design Patent**  
**Liu**

(10) **Patent No.:** **US D883,958 S**

(45) **Date of Patent:** **\*\* May 12, 2020**

(54) **PAIR OF EARPHONES**

(71) Applicant: **Jianzhi Liu, Jiangxi (CN)**

(72) Inventor: **Jianzhi Liu, Jiangxi (CN)**

(\*\*) Term: **15 Years**

(21) Appl. No.: **29/663,196**

(22) Filed: **Sep. 13, 2018**

(51) **LOC (12) Cl.** ..... **14-01**

(52) **U.S. Cl.**

USPC ..... **D14/223**

(58) **Field of Classification Search**

USPC ..... D14/223, 205; D3/218, 201, 200, 203.6,  
D3/205, 294; D9/700, 748, 721, 423,  
D9/415, 446, 428; D13/107; D28/61;  
206/702, 751, 573, 538, 320; 220/4.22;  
455/90.3, 575.1, 569.1

CPC ..... H04R 1/10; H04R 1/1066; H04R 1/1016;  
H04R 5/033; H04R 5/0335; H04R 25/00;  
H04R 25/02; H04R 1/1033; H02J 7/025

See application file for complete search history.

(56) **References Cited**

**U.S. PATENT DOCUMENTS**

D281,033 S *	10/1985	Mohri	.....	D3/295
D351,082 S *	10/1994	Long	.....	D6/407
5,887,720 A *	3/1999	Lin	.....	H04R 1/10 206/38
D506,744 S *	6/2005	Andre	.....	D14/205
D529,288 S *	10/2006	Ham	.....	D3/294
D604,501 S *	11/2009	Lee	.....	D3/201
D667,301 S *	9/2012	Jones	.....	D9/456
D673,430 S *	1/2013	Glassman	.....	D3/201
D687,021 S *	7/2013	Yuen	.....	D14/223
9,087,506 B1 *	7/2015	Kraft	.....	G10L 21/0232
D738,110 S *	9/2015	Jiang	.....	D3/294
9,131,308 B2 *	9/2015	Kraft	.....	G10L 21/0232
D740,018 S *	10/2015	Zhang	.....	D3/201

D772,572 S *	11/2016	Palmborg	.....	D3/201
9,565,491 B2 *	2/2017	Baker	.....	H04R 1/1083
D782,997 S *	4/2017	Shin	.....	D14/205
D782,998 S *	4/2017	Shin	.....	D14/205
D788,079 S *	5/2017	Son	.....	D14/223
D798,843 S *	10/2017	Valenzuela	.....	D14/223
D800,097 S *	10/2017	Chen	.....	D14/223
D805,060 S *	12/2017	Loermann	.....	D14/223
D806,388 S *	1/2018	Akana	.....	D3/294
D806,879 S *	1/2018	Horbinski	.....	D24/174
D810,054 S *	2/2018	Yuan	.....	D14/223
D812,042 S *	3/2018	Xiao	.....	D14/223
D813,206 S *	3/2018	Tang	.....	D14/223
D813,848 S *	3/2018	Palmborg	.....	D14/223
D817,309 S *	5/2018	Czaniecki	.....	D14/223
D818,268 S *	5/2018	Akana	.....	D3/294
D818,990 S *	5/2018	Tzeng	.....	D14/205

(Continued)

**FOREIGN PATENT DOCUMENTS**

CN	305275054	*	7/2019
CN	305302022	*	8/2019

(Continued)

*Primary Examiner* — Paula Allen Greene

(74) *Attorney, Agent, or Firm* — Justin Lampel

(57) **CLAIM**

The ornamental design for an pair of earphones, as shown and described.

**DESCRIPTION**

FIG. 1 is a perspective view of an pair of earphones showing my new design;

FIG. 2 is a front elevational view thereof;

FIG. 3 is a rear elevational view thereof;

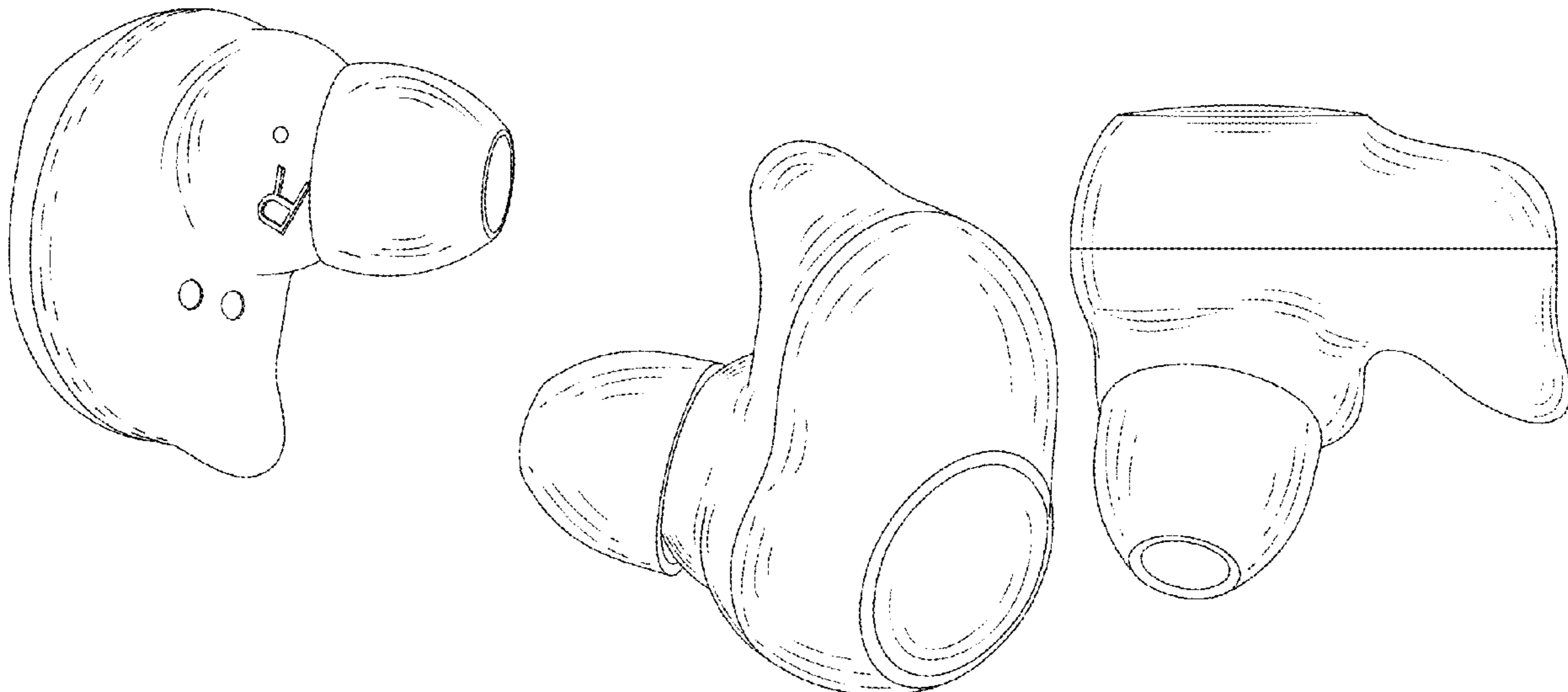
FIG. 4 is a right side view thereof;

FIG. 5 is a left side view thereof;

FIG. 6 is a bottom plan view thereof; and,

FIG. 7 is a top plan view thereof.

**1 Claim, 7 Drawing Sheets**



(56)

**References Cited**

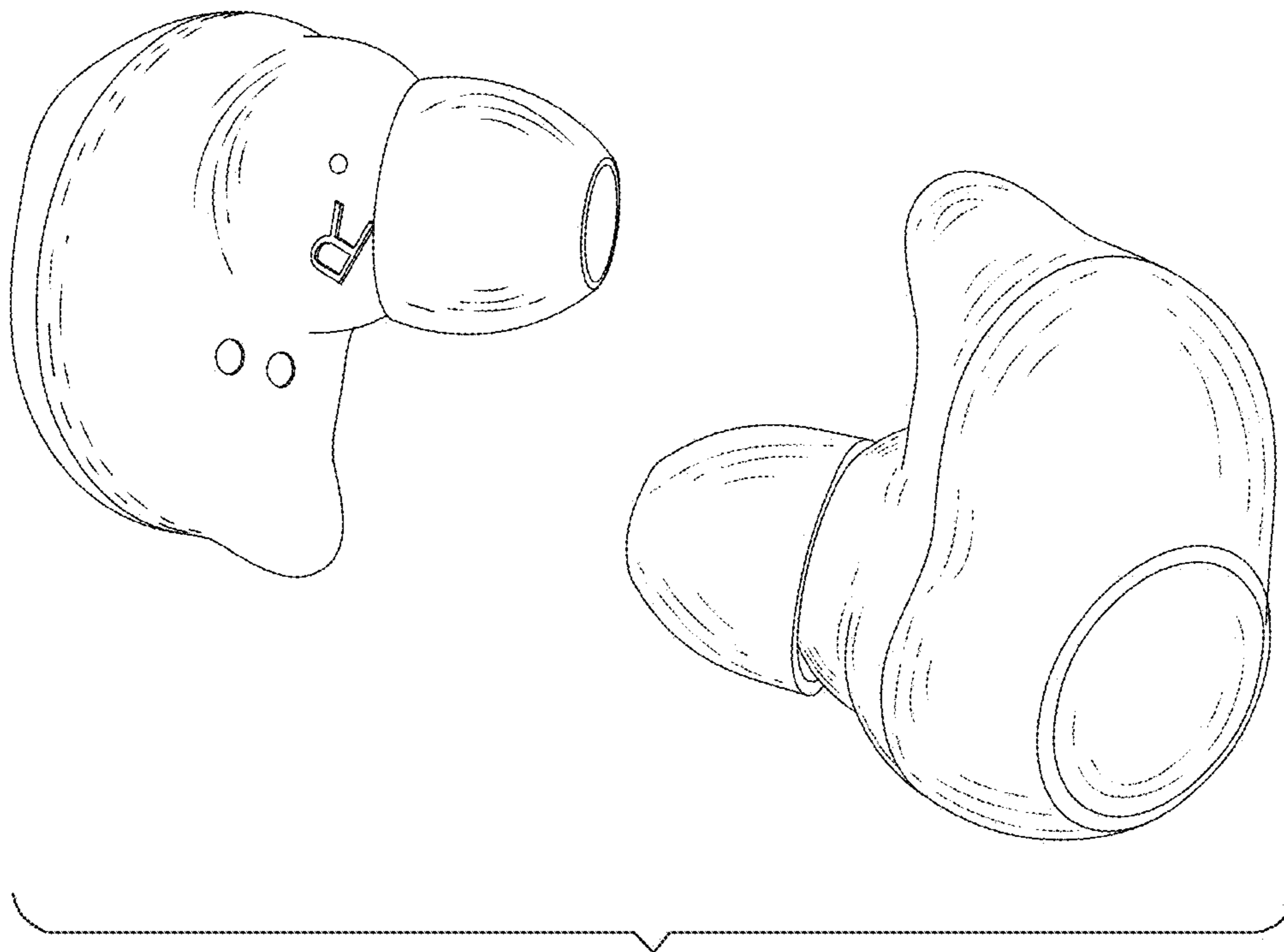
U.S. PATENT DOCUMENTS

D821,970 S \* 7/2018 Loermann ..... D13/107  
 D826,211 S \* 8/2018 Kim ..... D14/206  
 D838,480 S \* 1/2019 Son ..... D3/294  
 10,178,464 B2 \* 1/2019 Hussein ..... A61F 11/08  
 D841,580 S \* 2/2019 Bao ..... D13/108  
 D841,626 S \* 2/2019 Tang ..... D14/223  
 D841,627 S \* 2/2019 Wen ..... D14/223  
 D843,354 S \* 3/2019 Kumano ..... D14/223  
 10,234,133 B2 \* 3/2019 Hirsch ..... F21V 33/0056  
 D845,932 S \* 4/2019 Lu ..... D14/223  
 D846,264 S \* 4/2019 Wu ..... D3/201  
 D846,532 S \* 4/2019 Xiao ..... D14/223  
 D849,401 S \* 5/2019 Akana ..... D3/274  
 D850,365 S \* 6/2019 Loermann ..... D13/107  
 D851,072 S \* 6/2019 McNamara ..... D14/223  
 D852,782 S \* 7/2019 Bergman ..... D14/223  
 D853,116 S \* 7/2019 Bergman ..... D3/294  
 D855,589 S \* 8/2019 Madsen ..... D14/223  
 D862,424 S \* 10/2019 You ..... D14/223  
 D863,260 S \* 10/2019 Zheng ..... D14/223  
 D863,261 S \* 10/2019 Zhu ..... D14/223  
 D864,167 S \* 10/2019 Wu ..... D14/223  
 D868,752 S \* 12/2019 Zhu ..... D14/223  
 D872,064 S \* 1/2020 Cai ..... D14/223  
 D873,248 S \* 1/2020 Weicheng ..... D14/223  
 D873,805 S \* 1/2020 Yang ..... D14/223  
 2008/0292123 A1 \* 11/2008 Jensen ..... H04R 25/00  
 381/322

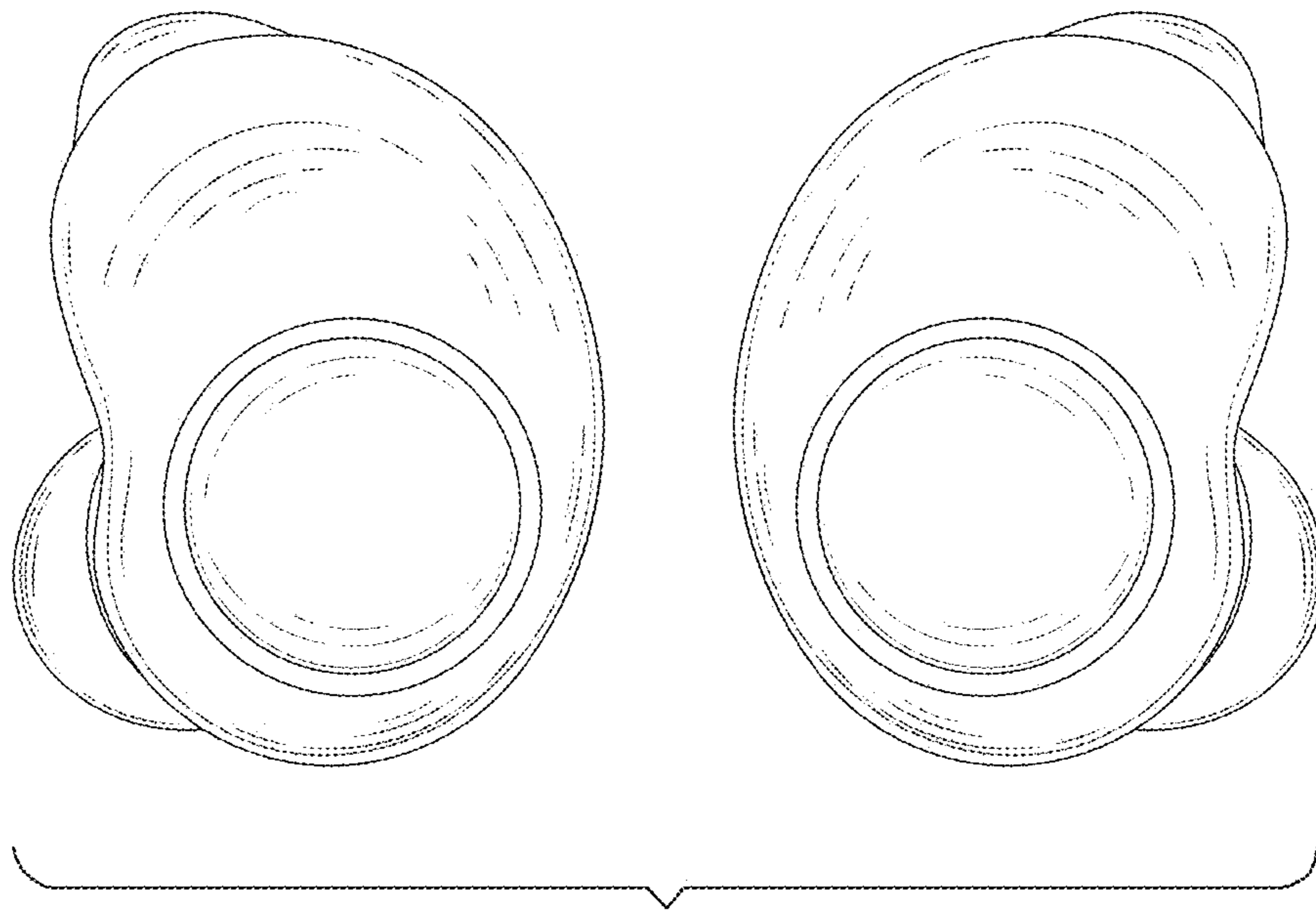
FOREIGN PATENT DOCUMENTS

EM 002641605-0001 \* 2/2015  
 EM 006148557-0001 \* 2/2019

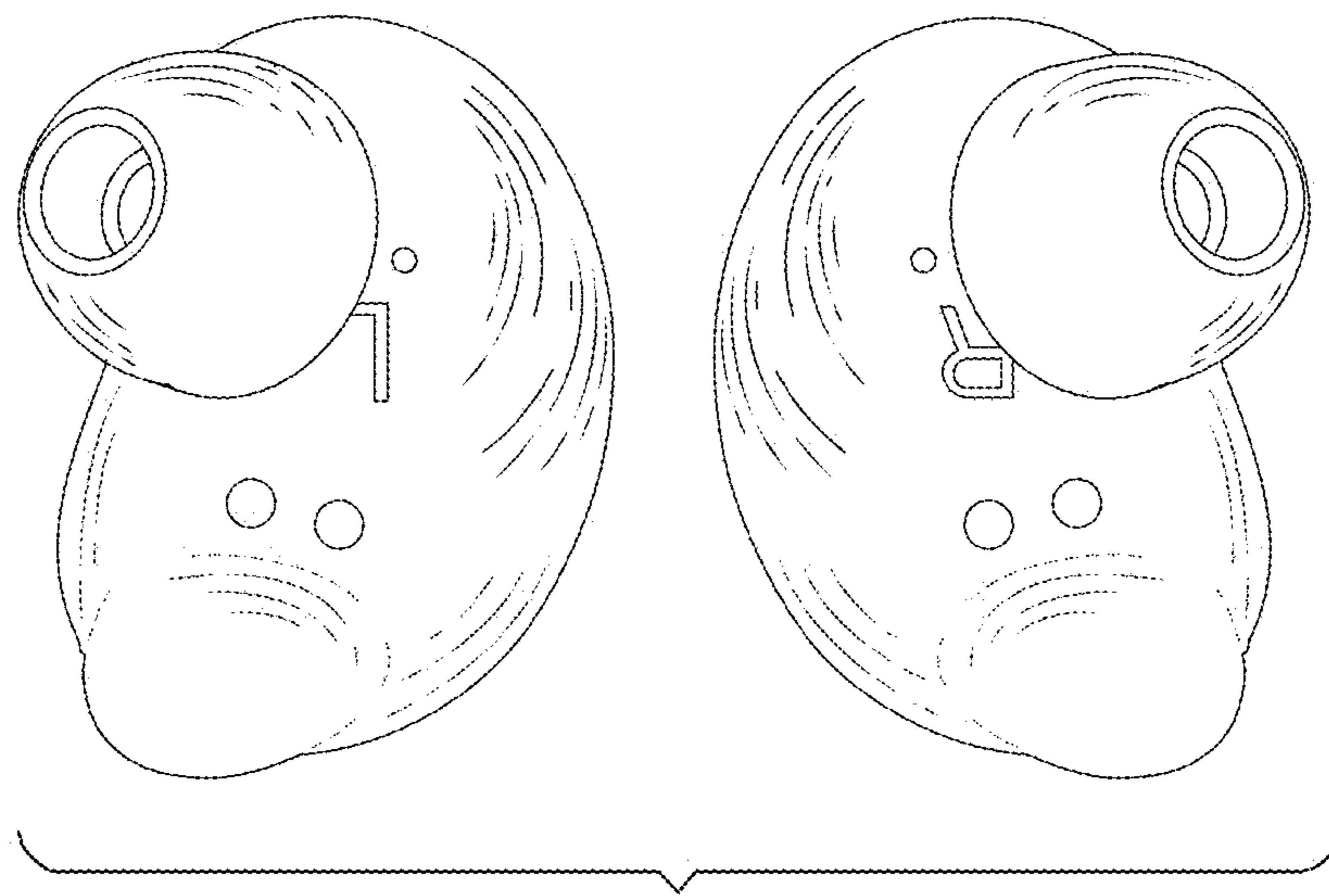
\* cited by examiner



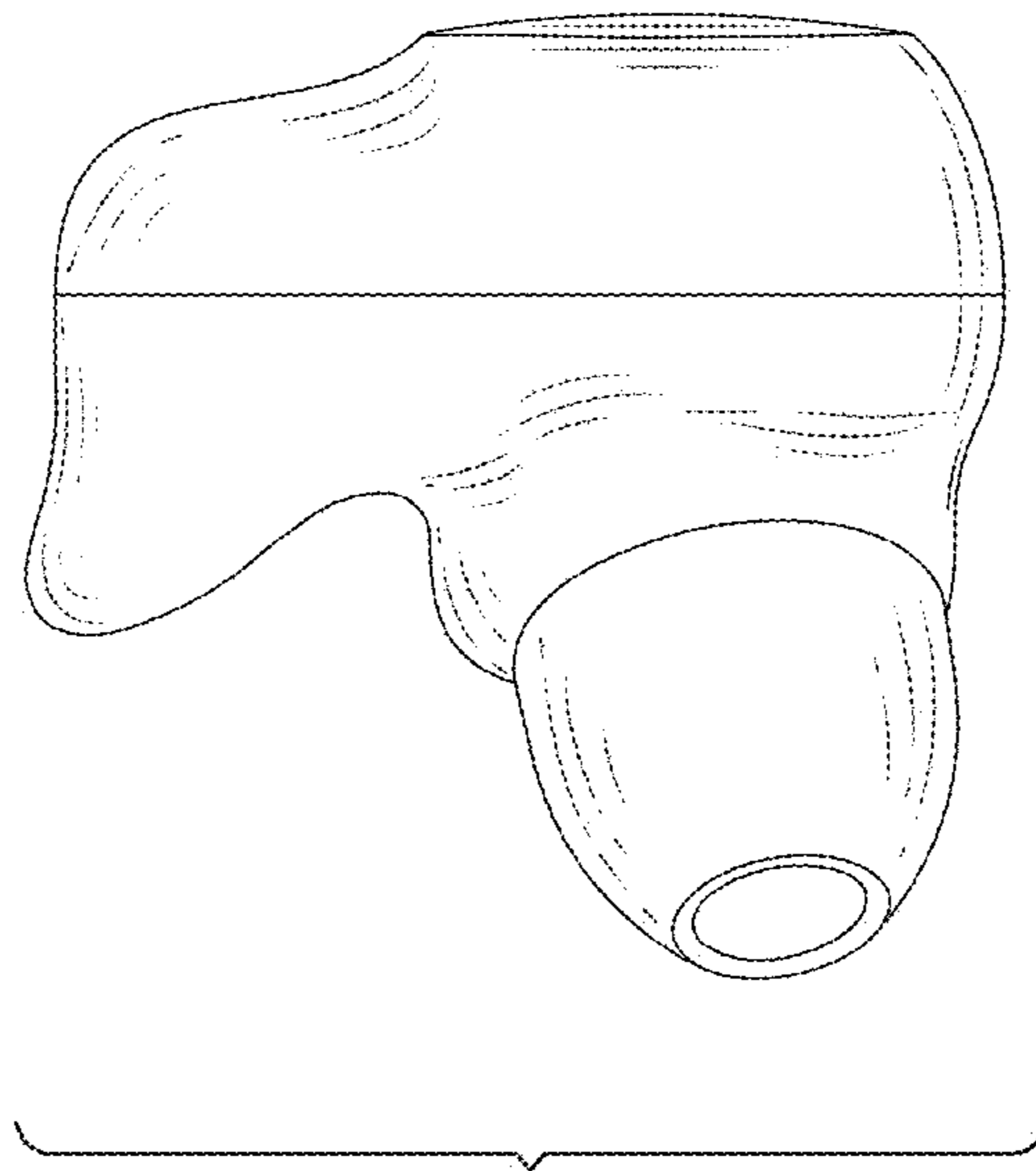
**FIG. 1**



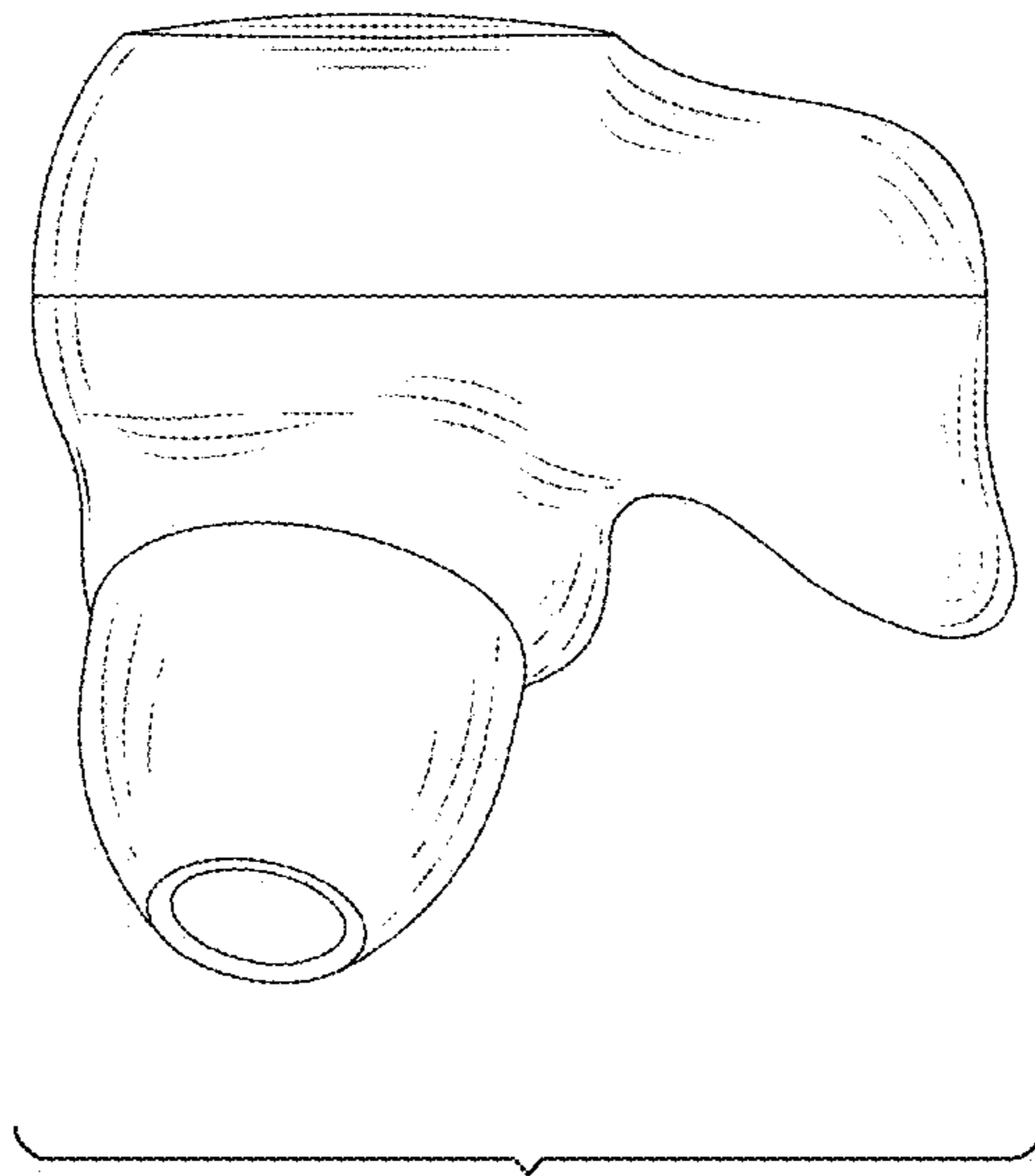
**FIG. 2**



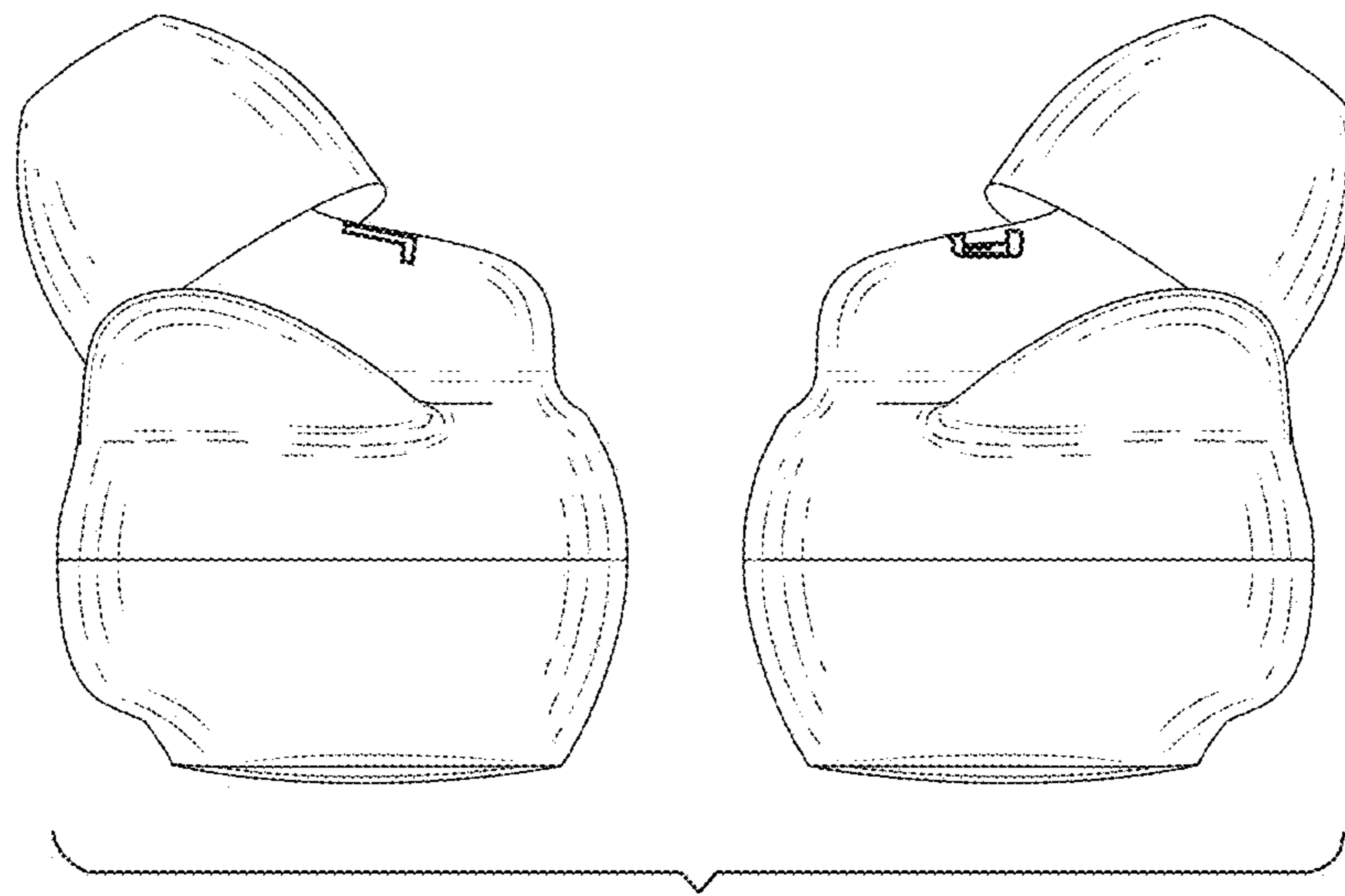
**FIG. 3**



**FIG. 4**

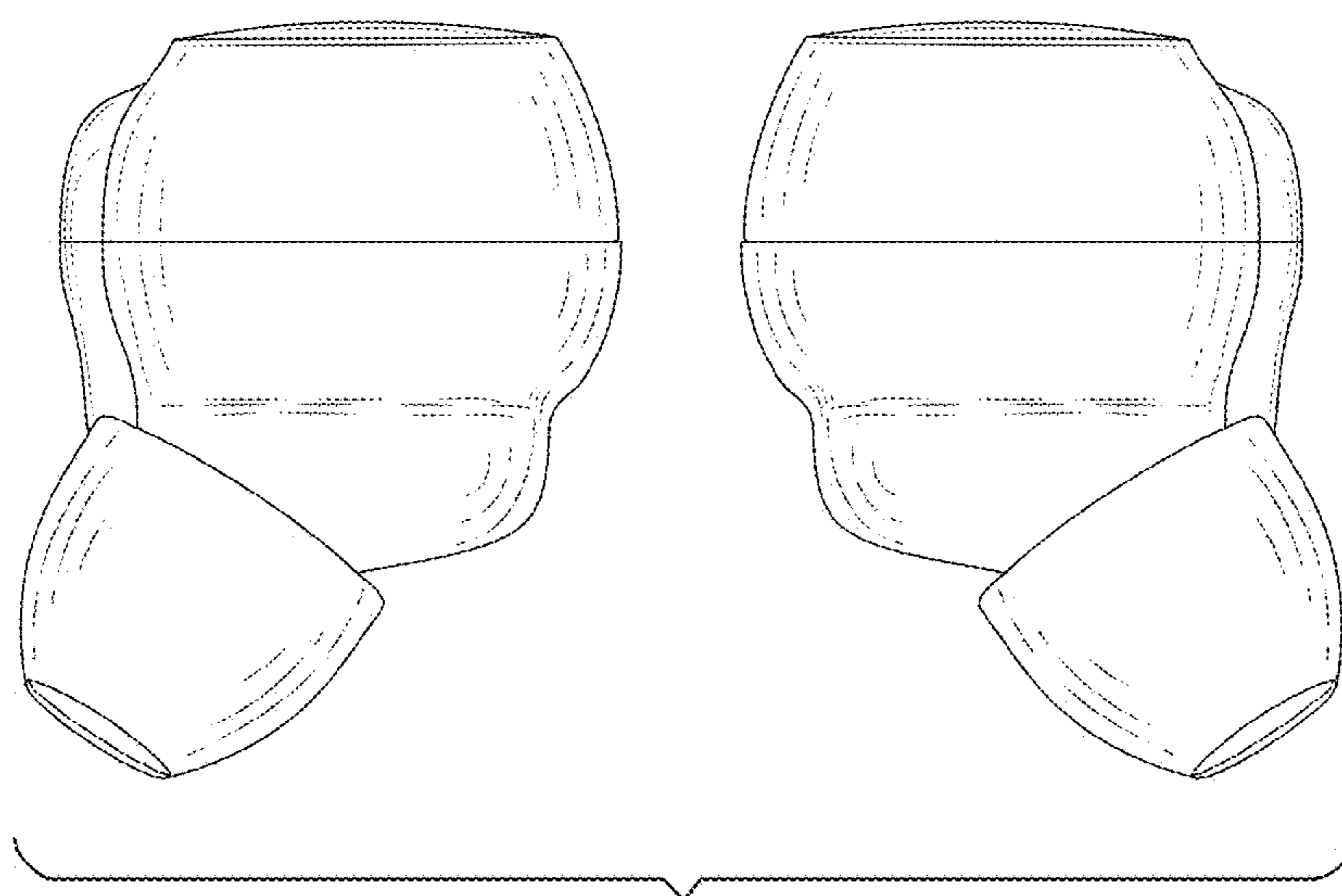


**FIG. 5**



**FIG. 6**





**FIG. 7**