



US00D883953S

(12) **United States Design Patent** (10) **Patent No.:** **US D883,953 S**
Chong et al. (45) **Date of Patent:** **** May 12, 2020**

(54) **SOUND BAR**

(71) Applicant: **LG ELECTRONICS INC.**, Seoul (KR)

(72) Inventors: **Yuonui Chong**, Seoul (KR); **Junki Kim**, Seoul (KR); **Sungyong Park**, Seoul (KR); **Sooyoung Park**, Seoul (KR)

(73) Assignee: **LG Electronics Inc.**, Seoul (KR)

(**) Term: **15 Years**

(21) Appl. No.: **35/505,382**

(22) Filed: **Jan. 26, 2018**

(80) **Hague Agreement Data**

Int. Filing Date: **Jan. 26, 2018**

Int. Reg. No.: **DM/099996**

Int. Reg. Date: **Jan. 26, 2018**

Int. Reg. Pub. Date: **Jul. 27, 2018**

(30) **Foreign Application Priority Data**

Jul. 28, 2017 (KR) 30-2017-0035108

(51) **LOC (12) Cl.** **14-01**

(52) **U.S. Cl.**
USPC **D14/214**

(58) **Field of Classification Search**

USPC D14/204-216, 221, 265, 496-506, 188,
D14/194-198, 203.1, 203.8, 136, 165,
D14/168, 172

CPC H04R 1/02; H04R 1/021; H04R 1/023;
H04R 5/00; H04R 9/06; H04R 2420/07;
H04R 1/025; H04R 1/026; H04R 1/323;
H04R 1/403; H04R 1/2803; H04R
1/2834; H04R 5/02; H04R 2201/021;
H04R

(Continued)

(56) **References Cited**

U.S. PATENT DOCUMENTS

D715,257 S * 10/2014 Son D14/214
D745,488 S * 12/2015 Lee D14/204

(Continued)

FOREIGN PATENT DOCUMENTS

WO WO D099996-001 * 7/2018

OTHER PUBLICATIONS

LG SL7Y_ 3.1 Channel Sound Bar, no date available, [online], [site visited Apr. 9, 2019]. Retrieved from url:https://www.lg.com/us/home-audio/lg-SL7Y-sound-bar (Year: 2019).*

(Continued)

Primary Examiner — Jeffrey D Asch

Assistant Examiner — Tracey J Bell

(74) *Attorney, Agent, or Firm* — Birch, Stewart, Kolasch & Birch, LLP

(57) **CLAIM**

The ornamental design for a sound bar, as shown and described.

DESCRIPTION

- 1. Sound bar
- 1.1 : Enlarged perspective
- 1.2 : Front
- 1.3 : Back
- 1.4 : Enlarged left
- 1.5 : Enlarged right
- 1.6 : Top
- 1.7 : Bottom

The broken lines depict portions of the sound bar that form no part of the claimed design; reproduction 1.1 is an enlarged front perspective view of the sound bar; reproduction 1.2 is a front view thereof; reproduction 1.3 is a back view thereof; reproduction 1.4 is an enlarged left view

(Continued)

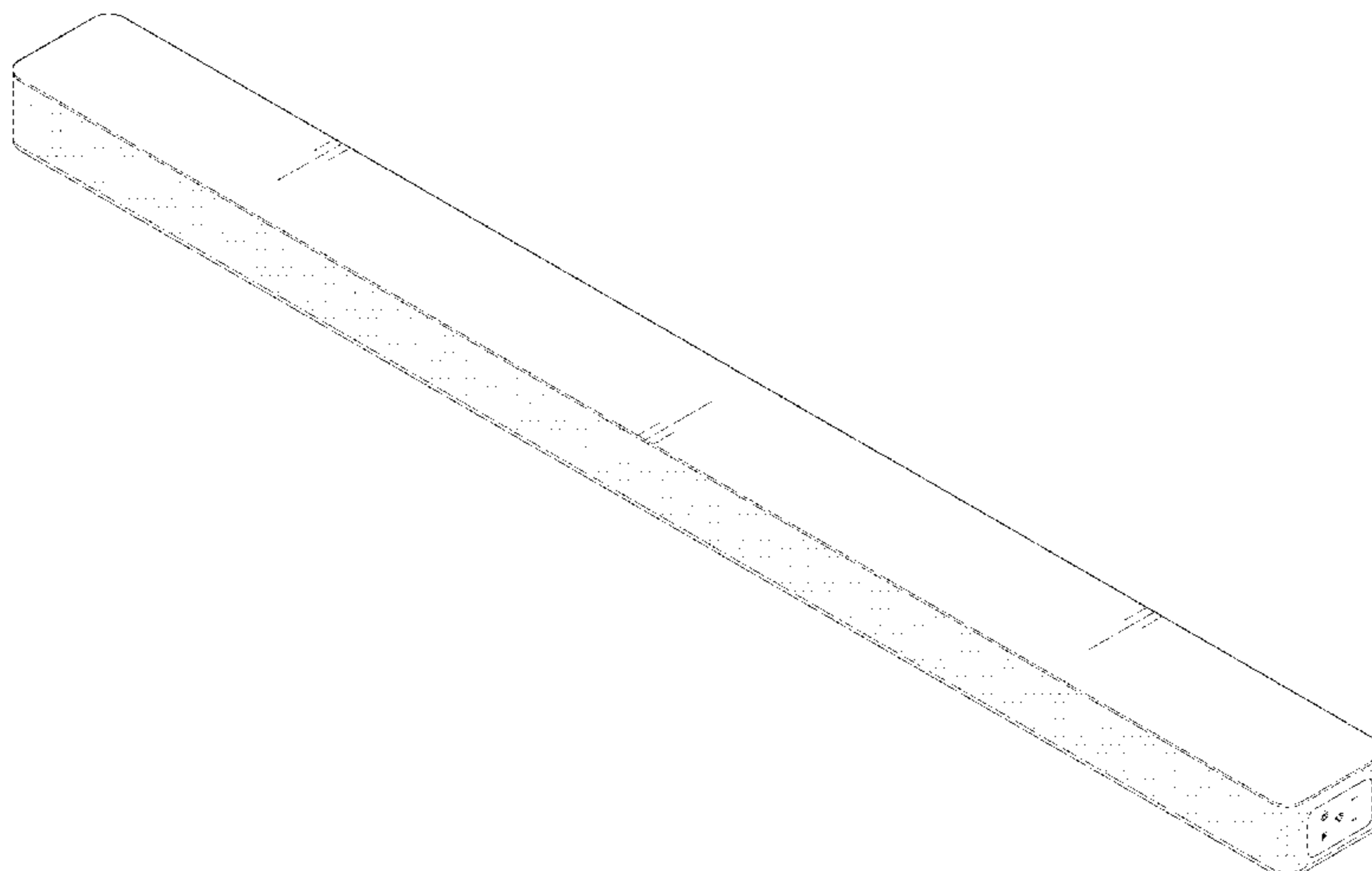

thereof; reproduction 1.5 is an enlarged right view thereof; reproduction 1.6 is a top view thereof; and reproduction 1.7 is a bottom view thereof.

1 Claim, 7 Drawing Sheets

(58) **Field of Classification Search**

CPC 2400/00; H04R 2400/07; H04R 2499/11;
G06F 1/1688

See application file for complete search history.

(56)

References Cited

U.S. PATENT DOCUMENTS

D754,100 S * 4/2016 McManigal D14/214
D759,624 S * 6/2016 Byrd D14/204
D759,629 S * 6/2016 Kusano D14/214
D763,238 S * 8/2016 Kim D14/126

D774,491 S * 12/2016 Kim D14/214
D778,259 S * 2/2017 Bouroullec D14/214
D791,736 S * 7/2017 Schoolmeester D14/214
D826,216 S * 8/2018 Schoolmeester D14/214
D826,892 S * 8/2018 Kim D14/204
D836,082 S * 12/2018 McManigal D14/204
2017/0079149 A1* 3/2017 Lee H01L 51/524

OTHER PUBLICATIONS

LG SL5Y_ 2.1 Channel Sound Bar, no date available, [online], [site visited Apr. 9, 2019]. Retrieved from url:<https://www.lg.com/us/home-audio/lg-SL5Y-sound-bar> (Year: 2019).*

LG SK6Y, no date available, [online], [site visited Apr. 9, 2019]. Retrieved from url:<https://www.lg.com/us/home-audio/lg-SK6Y-sound-bar> (Year: 2019).*

Bose Soundbar 700, released Sep. 20, 2018, [online], [site visited Apr. 15, 2019]. Retrieved from url:<https://www.bestbuy.ca/en-ca/product/bose-soundbar-700-black/12906563.aspx> (Year: 2018).*

* cited by examiner

1.1

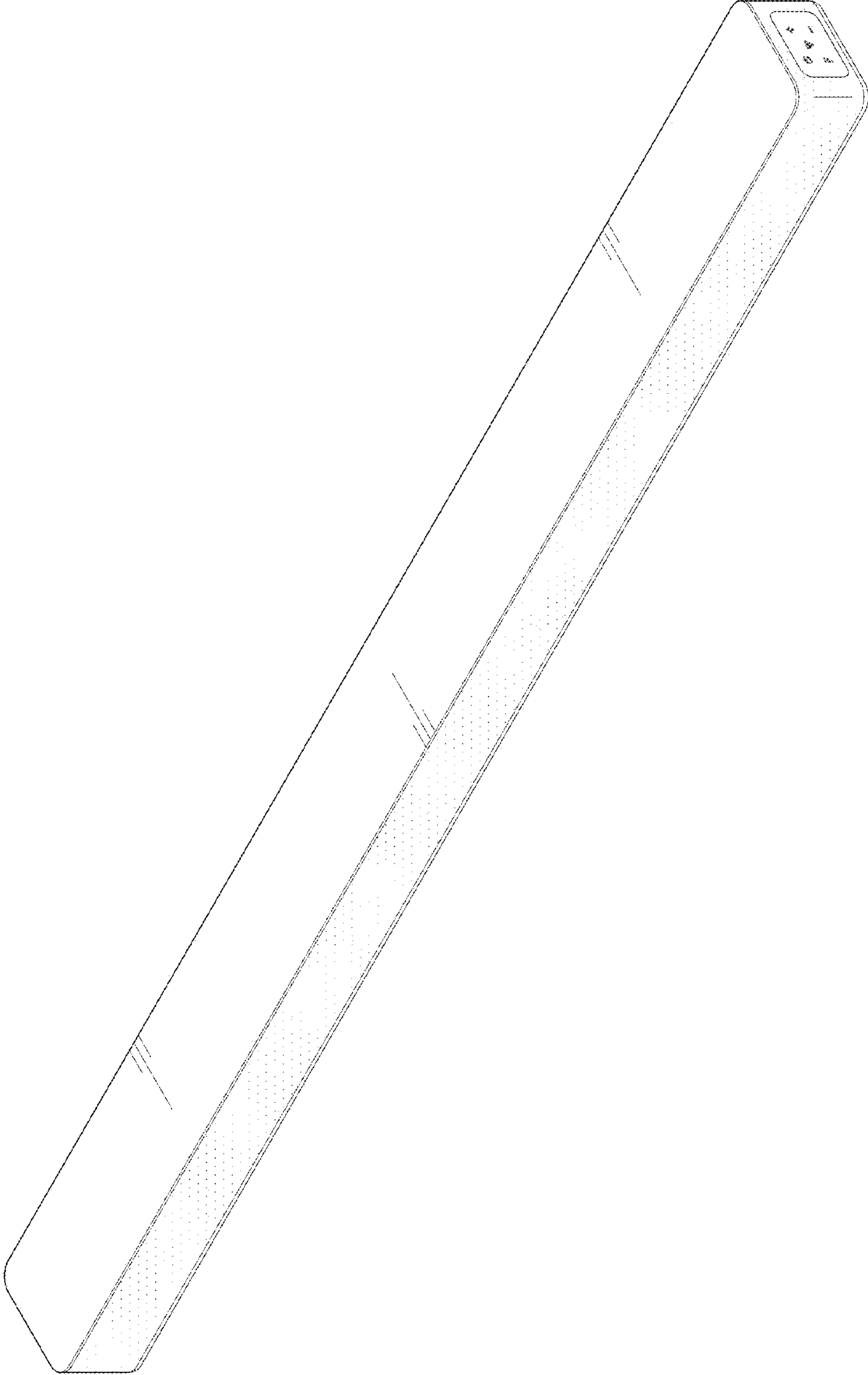

1.2

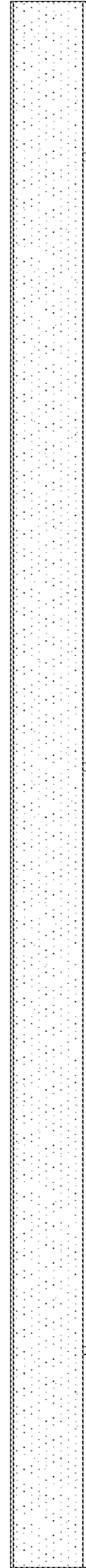

1.3

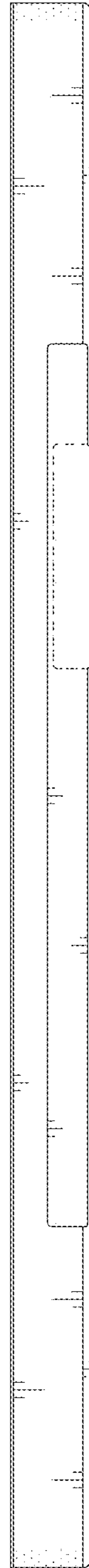

1.4

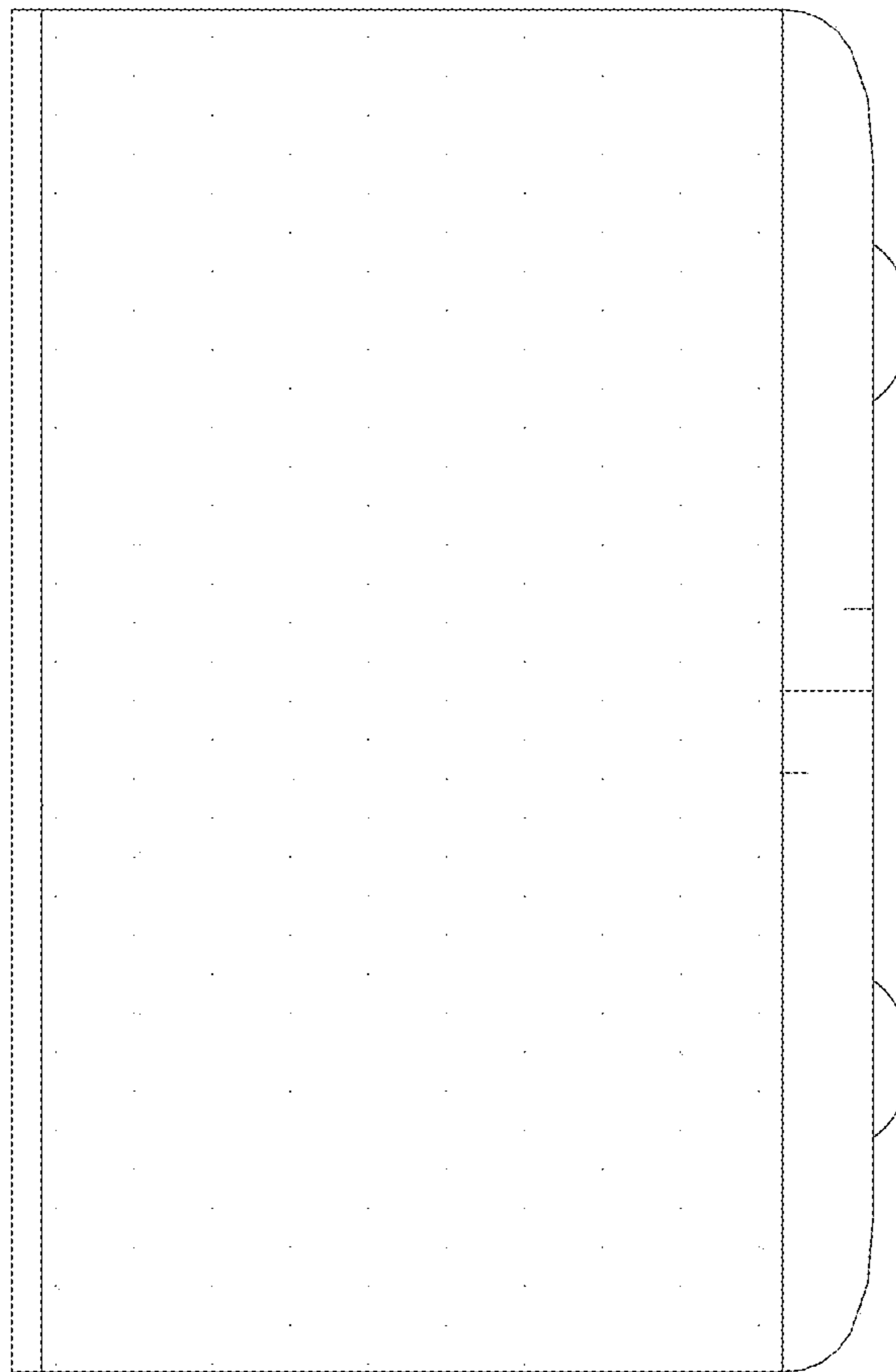

1.5

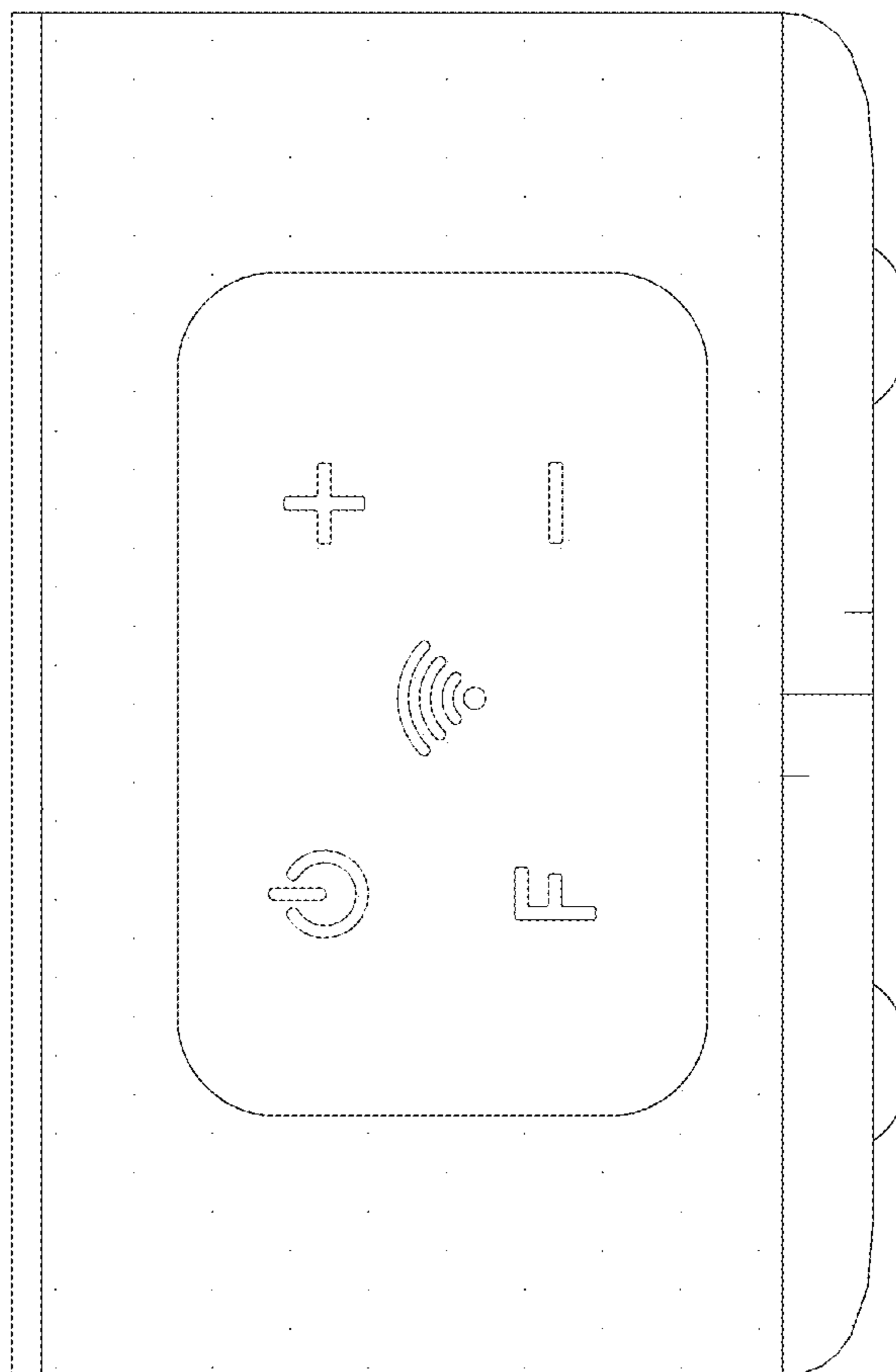

1.6

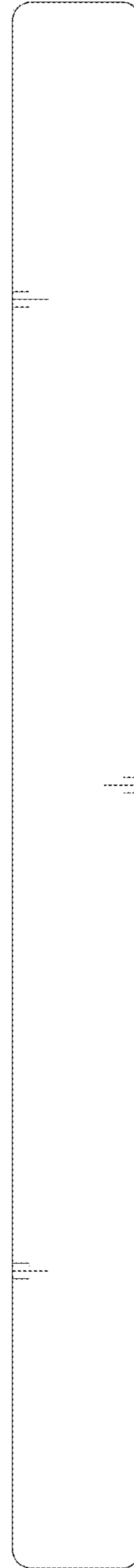

1.7

