



US00D883919S

(12) **United States Design Patent** (10) **Patent No.:** **US D883,919 S**
Gong (45) **Date of Patent:** **** May 12, 2020**

(54) **HANDHELD BATTERY CASE**

(71) Applicant: **Yelin Gong, Jiangxi (CN)**

(72) Inventor: **Yelin Gong, Jiangxi (CN)**

(**) Term: **15 Years**

(21) Appl. No.: **29/678,581**

(22) Filed: **Jan. 30, 2019**

(51) **LOC (12) Cl.** **13-02**

(52) **U.S. Cl.**
USPC **D13/103**

(58) **Field of Classification Search**

USPC D13/103, 107, 108, 110, 133,
D13/137.1-137.4, 138.1-138.2,
D13/139.1-139.8, 146, 147, 151-156,
D13/173, 177, 199; D14/432, 433, 435.1,
D14/250; D23/231, 232; D15/7-9;
D8/350, 353-356

CPC H01R 11/00; H01R 9/00; H01R 13/00;
H01R 13/04; H01R 13/10; H01R
13/6666; H01R 13/6675; H01R 25/00;
H01R 25/006; H01H 2207/00; H01H
2207/022; Y02E 60/12; Y02E 60/122;
Y02E 60/124; Y02E 60/50; H01M 2/02;
H01M 2/022; H01M 2/0202; H01M
2/0207; H01M 2/0212; H01M 2/1061;
H01M 2/1022; H01M 2/1055; H01M
2/1066; H01M 2/105; H01M 2/204; H02J
7/00; H02J 7/0003; H02J 7/0011; H02J
7/0013; H02J 7/0054; H02J 7/0055; H02J
7/0057; Y02T 10/7005; Y02T 10/705;
Y02T 10/7088; B60L 11/1809; B60L
11/1861

See application file for complete search history.

(56) **References Cited**

U.S. PATENT DOCUMENTS

D532,745 S * 11/2006 Gaber D13/108
D653,613 S * 2/2012 Sasada D13/108

D750,017 S * 2/2016 Miller D13/108
D765,649 S * 9/2016 Huang D14/253
D766,230 S * 9/2016 Shepard D14/253
D769,689 S * 10/2016 Squiers D8/83
D819,417 S * 6/2018 Graykowski D8/47
D819,423 S * 6/2018 Anderson D8/83
D841,724 S * 2/2019 Huang D16/243
D852,873 S * 7/2019 Fang D16/243
D865,676 S * 11/2019 Liao D13/147
2007/0172724 A1* 7/2007 Furth F21L 4/005
429/97
2010/0216011 A1* 8/2010 Yoo H01M 2/204
429/160
2011/0104522 A1* 5/2011 Morita H02J 7/0044
429/7

* cited by examiner

Primary Examiner — Rosemary K Tarcza

Assistant Examiner — Christy M Nemeth

(57) **CLAIM**

The ornamental design for a Handheld battery case, as shown and described.

DESCRIPTION

FIG. 1 is a perspective view of a handheld battery case showing my new design;
FIG. 2 is a front elevation view thereof;
FIG. 3 is a rear elevation view thereof;
FIG. 4 is a left side elevation view thereof;
FIG. 5 is a right side elevation view thereof;
FIG. 6 is an enlarged top plan view thereof;
FIG. 7 is an enlarged bottom plan view thereof; and,
FIG. 8 is a second perspective view thereof.
The broken lines illustrate environmental subject matter that forms no part of the claimed design.

1 Claim, 8 Drawing Sheets

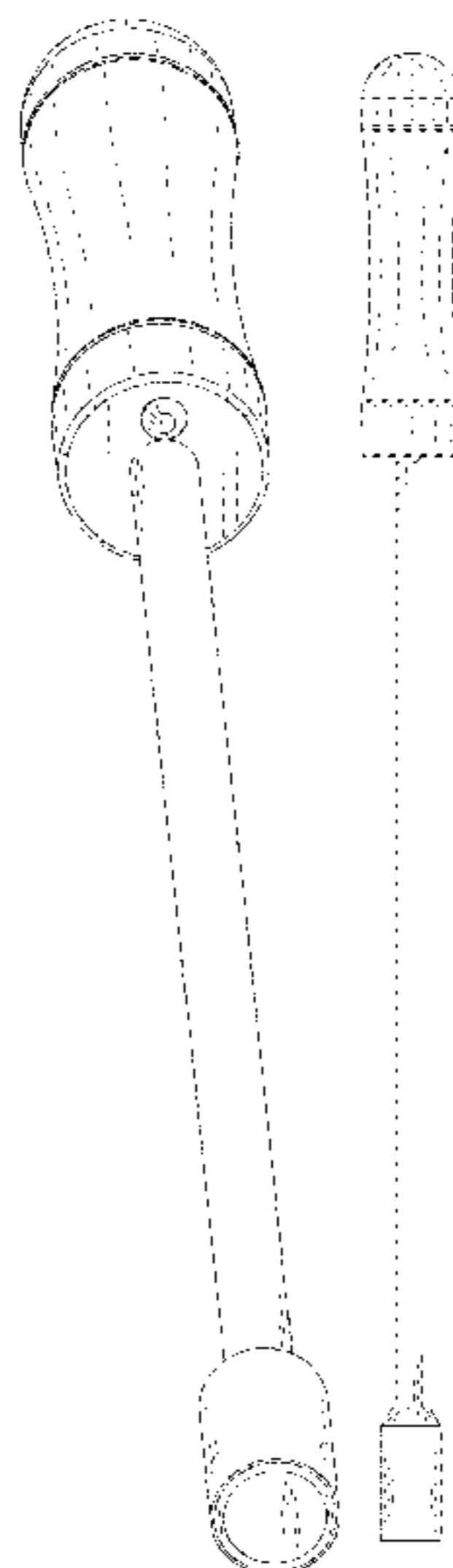

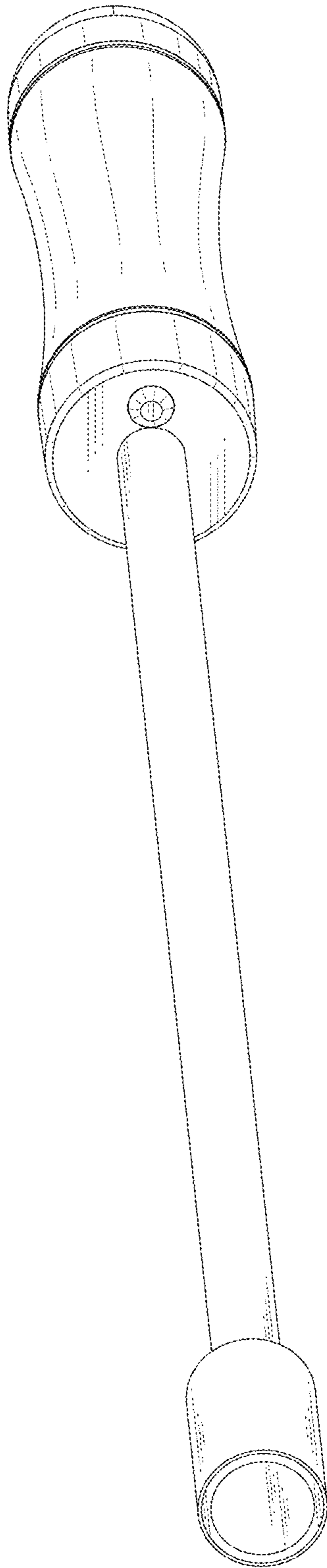

FIG. 1

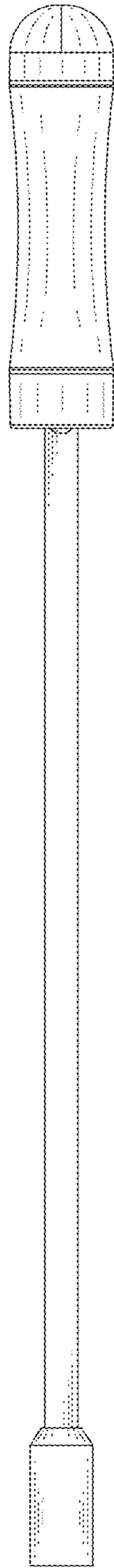

FIG.2

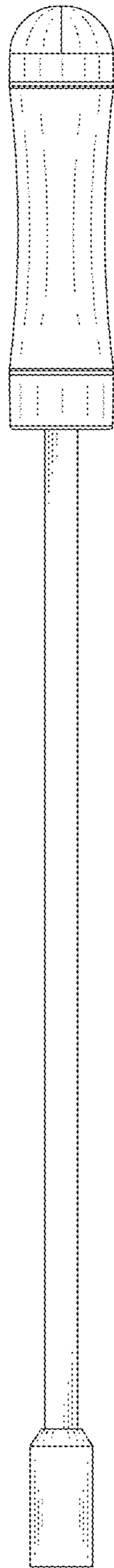

FIG.3

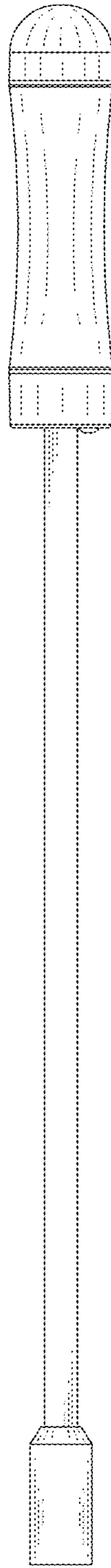

FIG.4

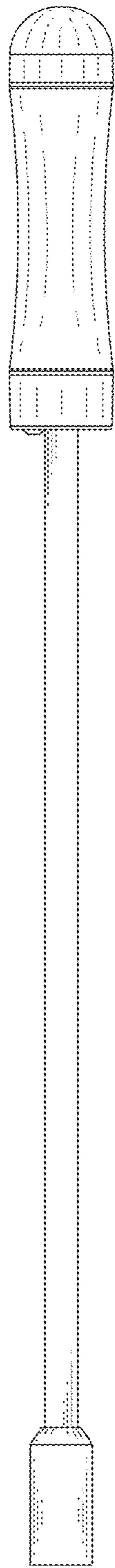

FIG.5

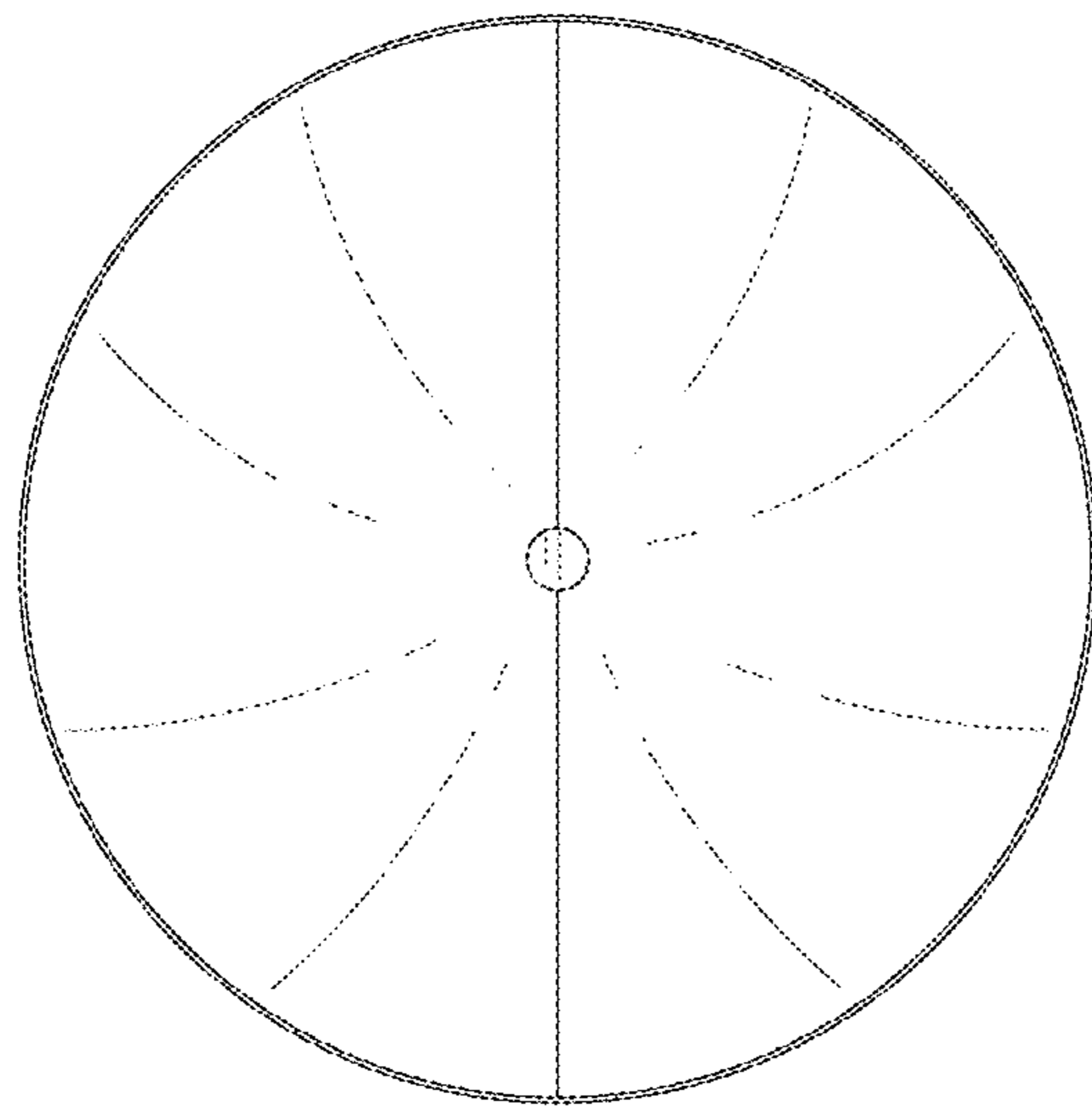

FIG.6

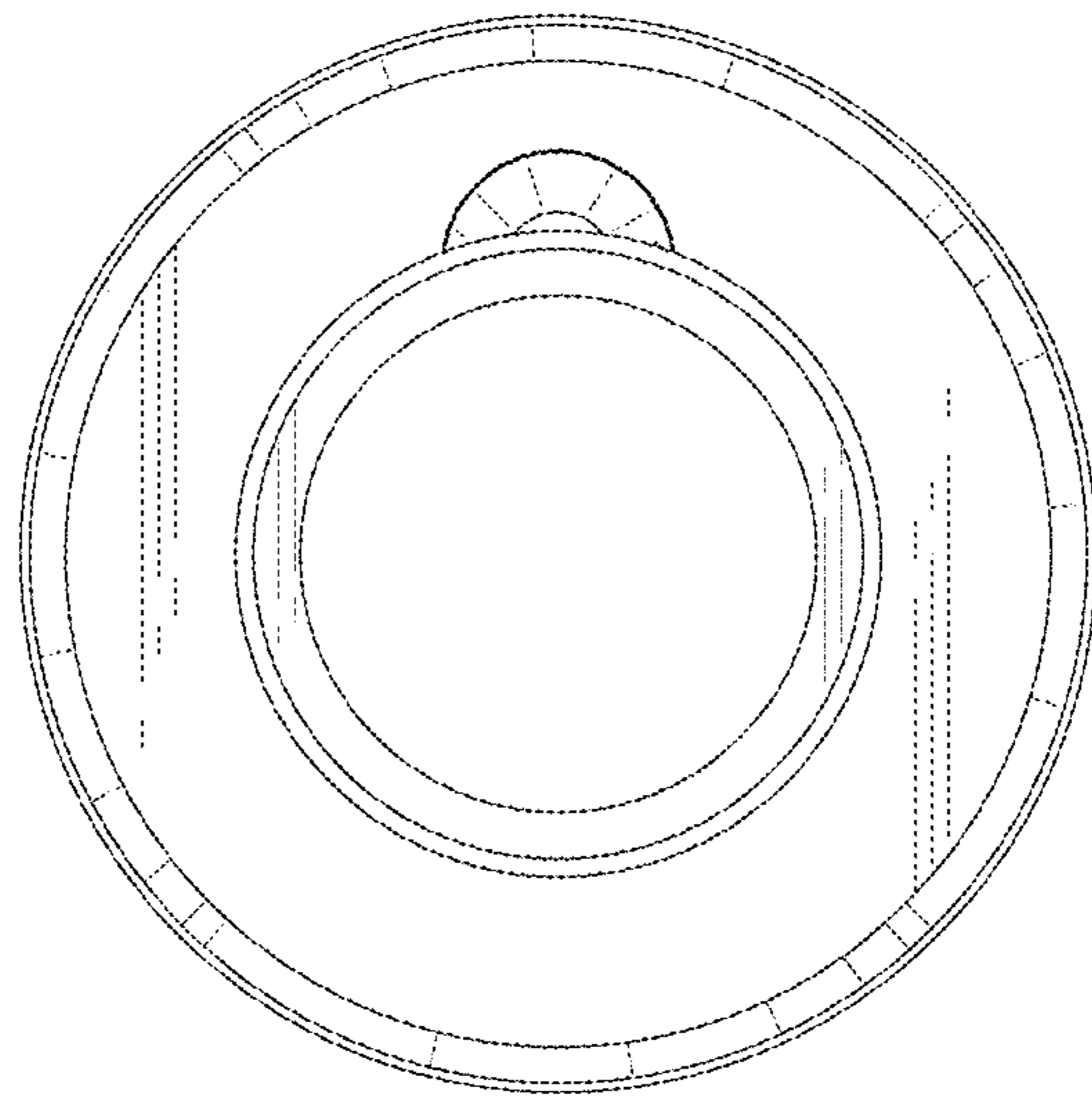

FIG.7

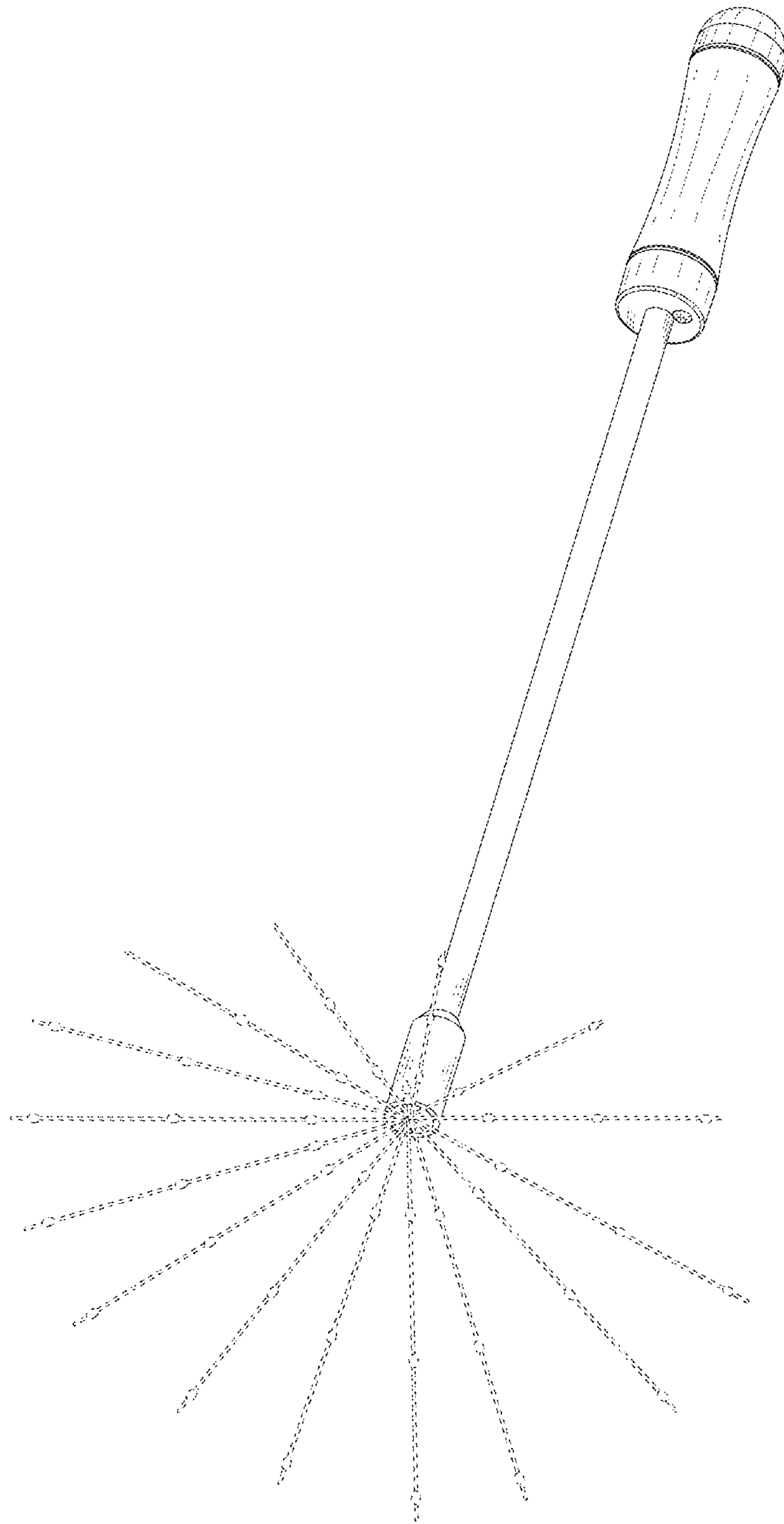

FIG. 8