



US00D883906S

(12) **United States Design Patent**
Voss et al.

(10) **Patent No.:** **US D883,906 S**

(45) **Date of Patent:** **** May 12, 2020**

(54) **TIRE**

(71) Applicant: **Compagnie Generale des Etablissements Michelin,**
Clermont-Ferrand (FR)

(72) Inventors: **Stefan Voss,** Greer, SC (US); **Nicholas Mailhiot,** Greenville, SC (US)

(73) Assignee: **COMPAGNIE GENERALE DES ETABLISSEMENTS MICHELIN,**
Clermont-Ferrand (FR)

(**) Term: **15 Years**

(21) Appl. No.: **29/670,550**

(22) Filed: **Nov. 16, 2018**

(51) **LOC (12) Cl.** **12-15**

(52) **U.S. Cl.**
USPC **D12/553**

(58) **Field of Classification Search**
USPC D12/533-567, 604
CPC Y10T 152/10027; B60C 1/0016; B60C 11/0306; B60C 11/0302; B60C 3/06; B60C 9/17
See application file for complete search history.

(56) **References Cited**

U.S. PATENT DOCUMENTS

| | | | | |
|--------------|---------|----------|-------|---------|
| D534,858 S * | 1/2007 | Le | | D12/553 |
| D604,226 S * | 11/2009 | Scheuren | | D12/553 |
| D662,873 S * | 7/2012 | Felder | | D12/553 |
| D691,942 S * | 10/2013 | Felder | | D12/553 |
| D740,743 S * | 10/2015 | Houis | | D12/553 |
| D744,410 S * | 12/2015 | Furusawa | | D12/553 |
| D750,013 S * | 2/2016 | Houis | | D12/553 |

(Continued)

Primary Examiner — Brandon M Rosati

Assistant Examiner — John A Voytek

(74) *Attorney, Agent, or Firm* — Neal P. Pierotti

(57) **CLAIM**

The ornamental design for a tire, as shown and described.

DESCRIPTION

FIG. 1 is a perspective view of a tire, it being understood that the tread is repeated throughout the circumference of the tire, it being understood that the dashed lines show environmental features of the tire.

FIG. 2 is a front view of the embodiment of FIG. 1.

FIG. 3 is a right side view of the embodiment of FIG. 1, the left side view having similarly shaped and sized features as the right side view.

FIG. 4 is a cross-sectional view taken along line 4-4 of FIG. 2.

FIG. 5 is a cross-sectional view taken along line 5-5 of FIG. 2.

FIG. 6 is a cross-sectional view taken along line 6-6 of FIG. 2.

FIG. 7 is a perspective view of a tire, it being understood that the tread is repeated throughout the circumference of the tire.

FIG. 8 is a front view of the embodiment of FIG. 7.

FIG. 9 is a right side view of the embodiment of FIG. 7, the left side view having similarly shaped and sized features as the right side view.

FIG. 10 is a cross-sectional view taken along line 10-10 of FIG. 8.

FIG. 11 is a cross-sectional view taken along line 11-11 of FIG. 8.

FIG. 12 is a cross-sectional view taken along line 12-12 of FIG. 8; and,

FIG. 13 is a close up view of a portion of the tread of FIG. 8 that shows some of the tread features in more detail, it being understood that the tread continues on above and below the dashed and dotted lines.

The dashed lines in the drawings denote environmental subject matter and do not form part of the following claim.

1 Claim, 13 Drawing Sheets

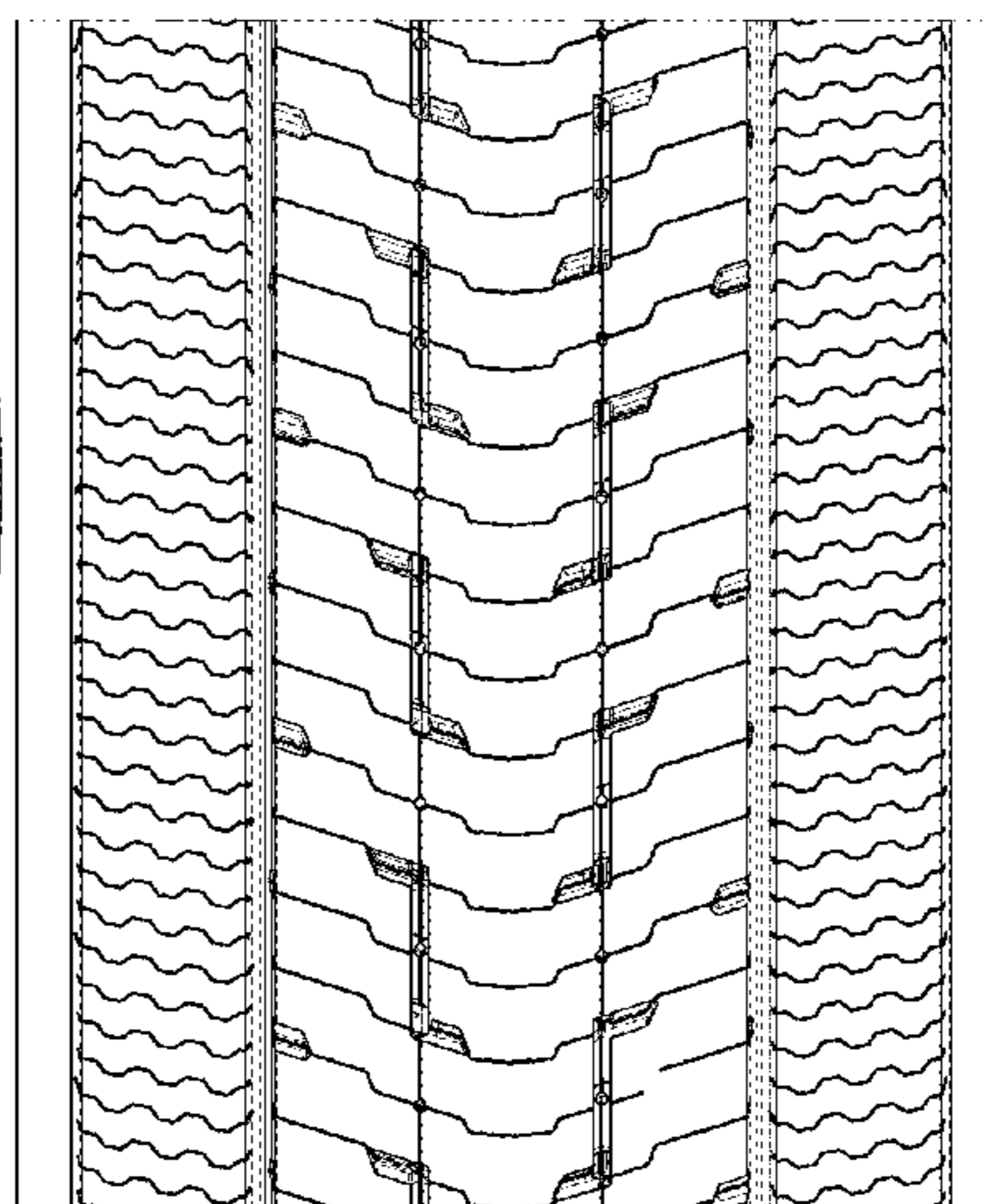
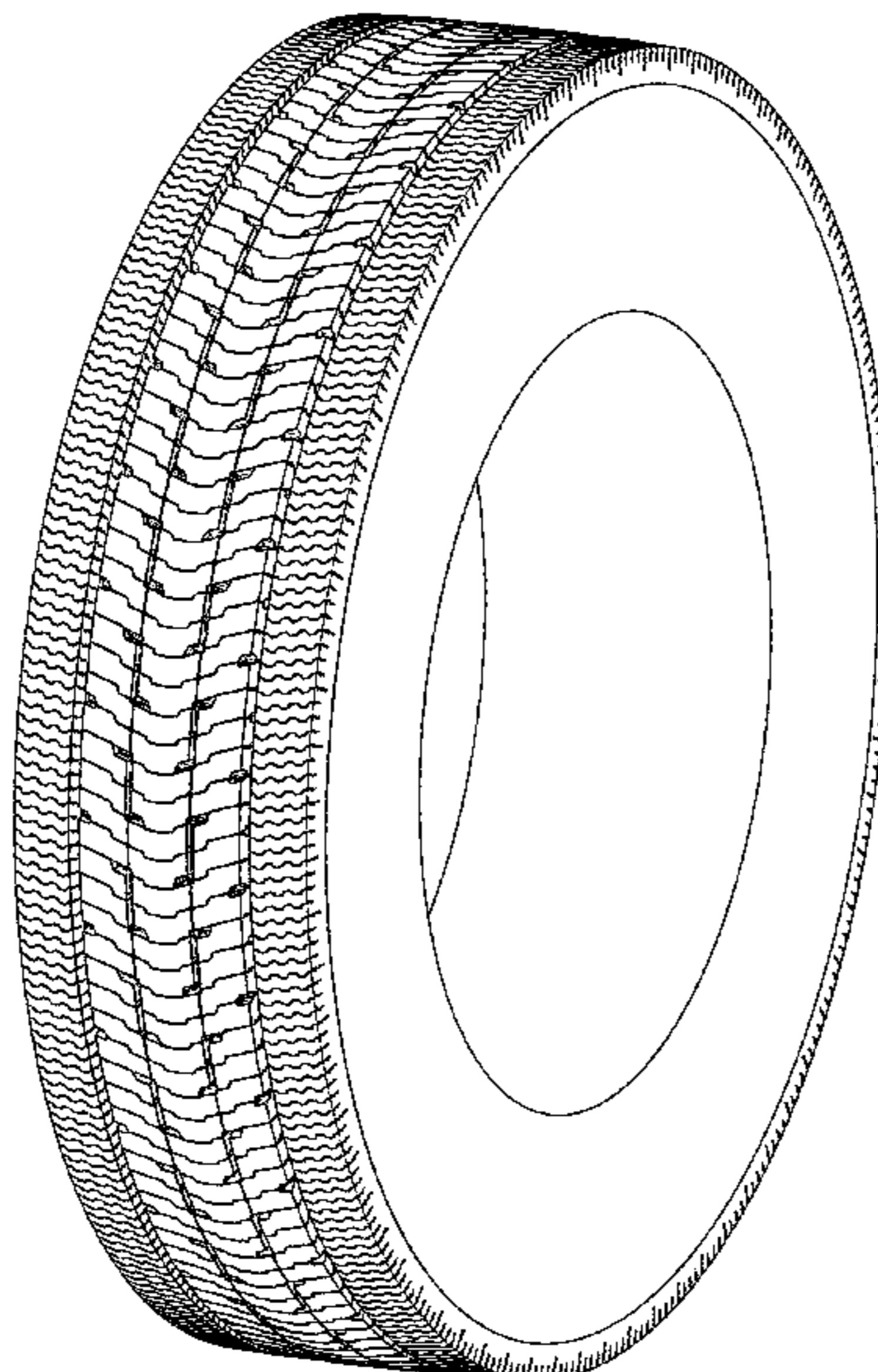

(56)

References Cited

U.S. PATENT DOCUMENTS

D784,246 S * 4/2017 Zhu D12/553
D784,247 S * 4/2017 Zhu D12/553
2011/0168311 A1* 7/2011 Voss B29D 30/0606
152/209.18
2018/0244111 A1* 8/2018 Zhu B60C 11/04

* cited by examiner

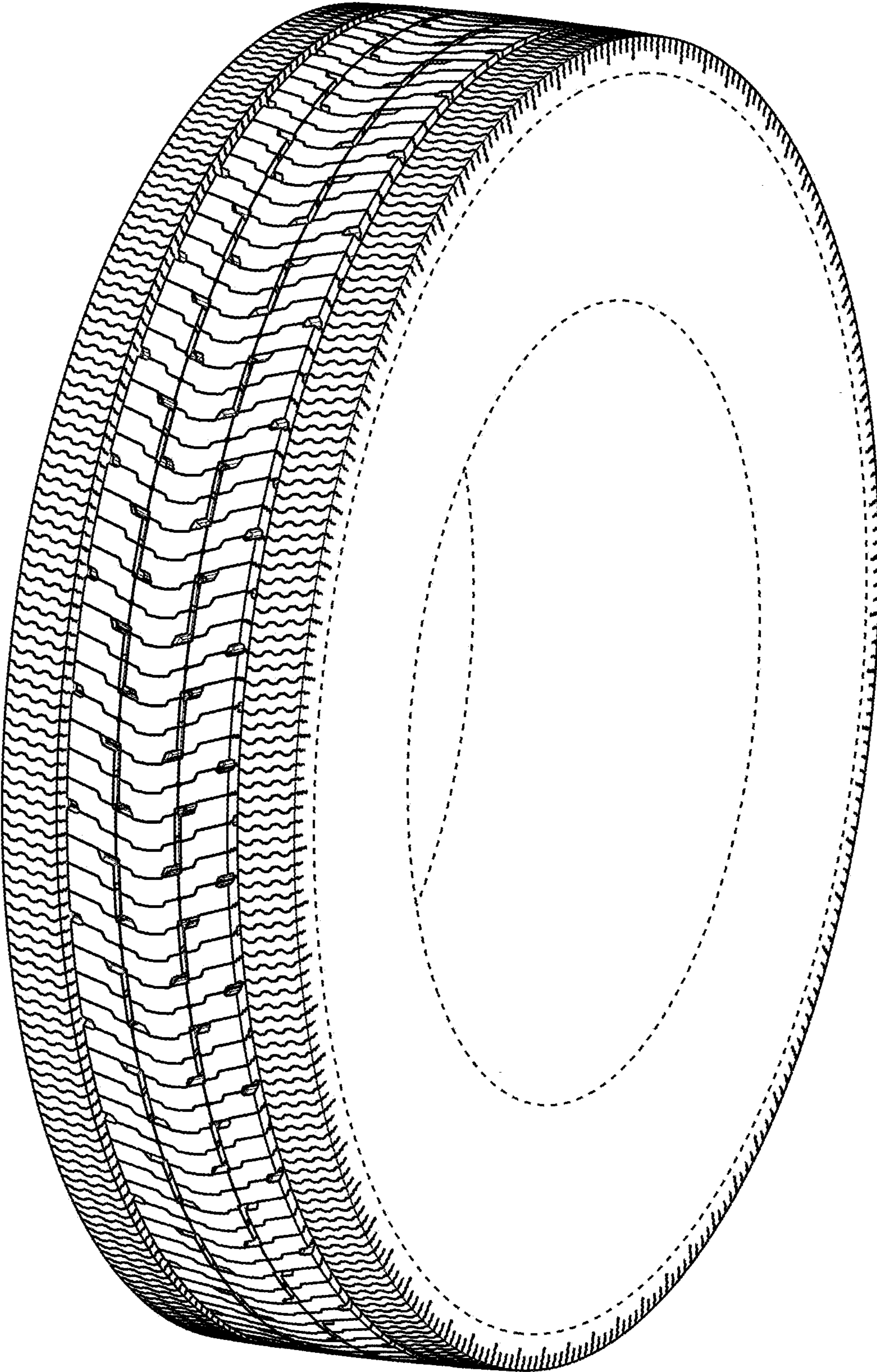

FIG. 1

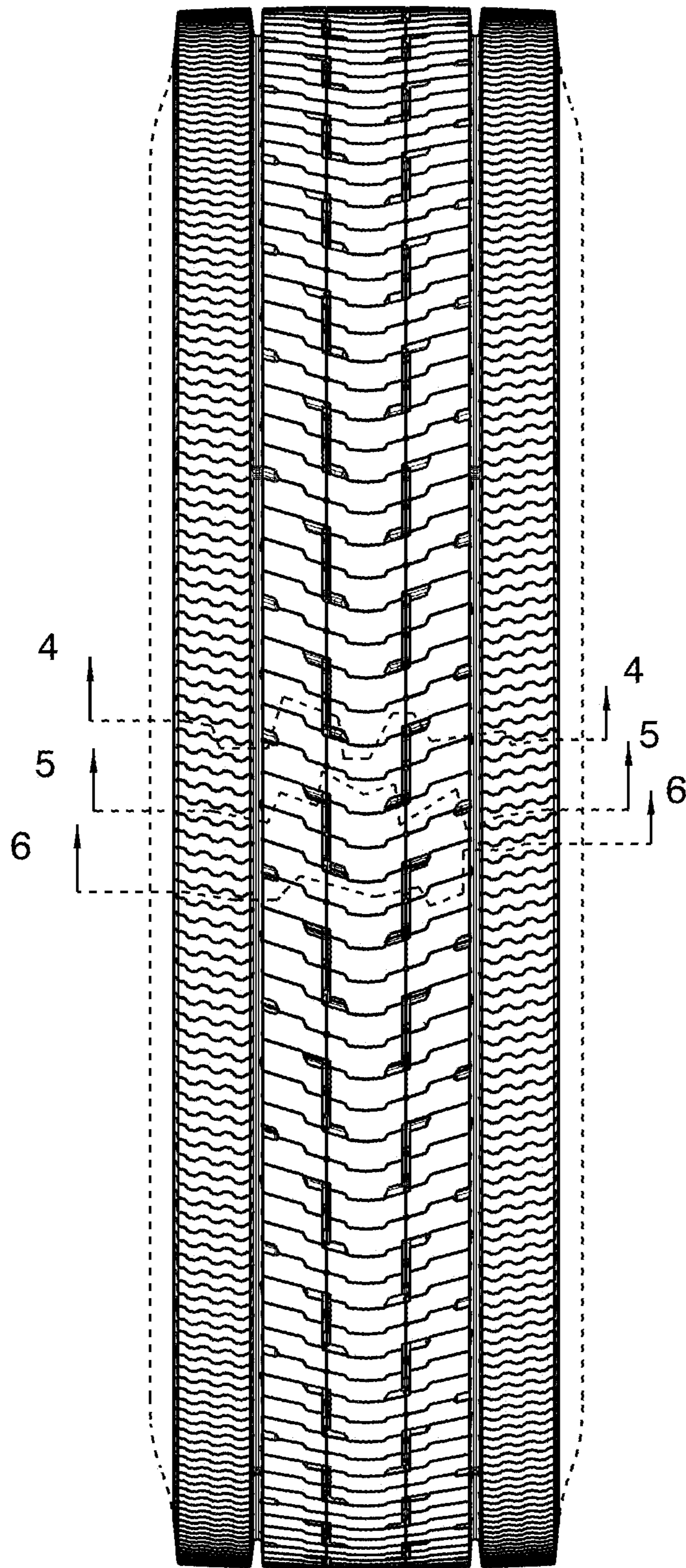

FIG. 2

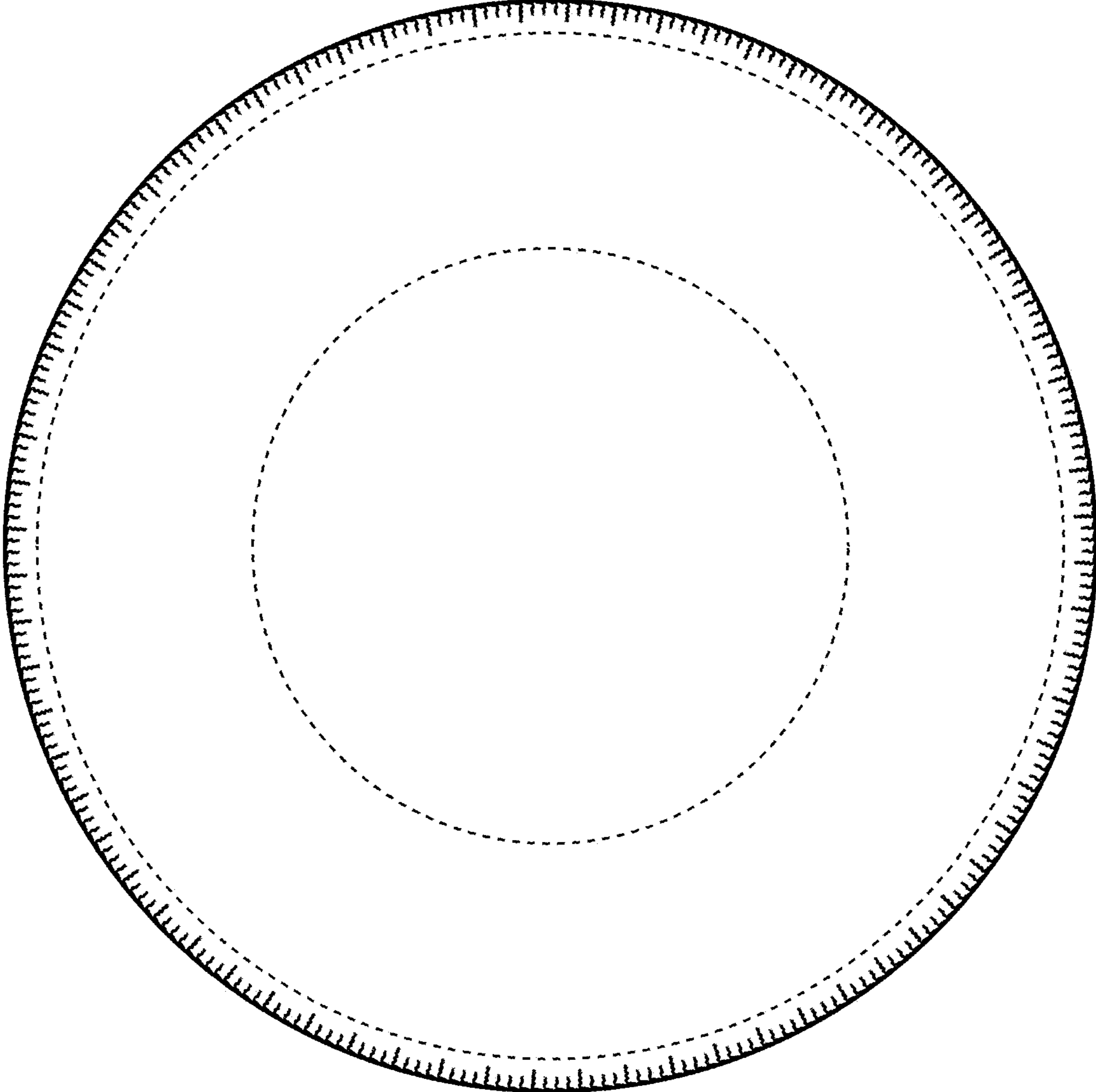

FIG. 3

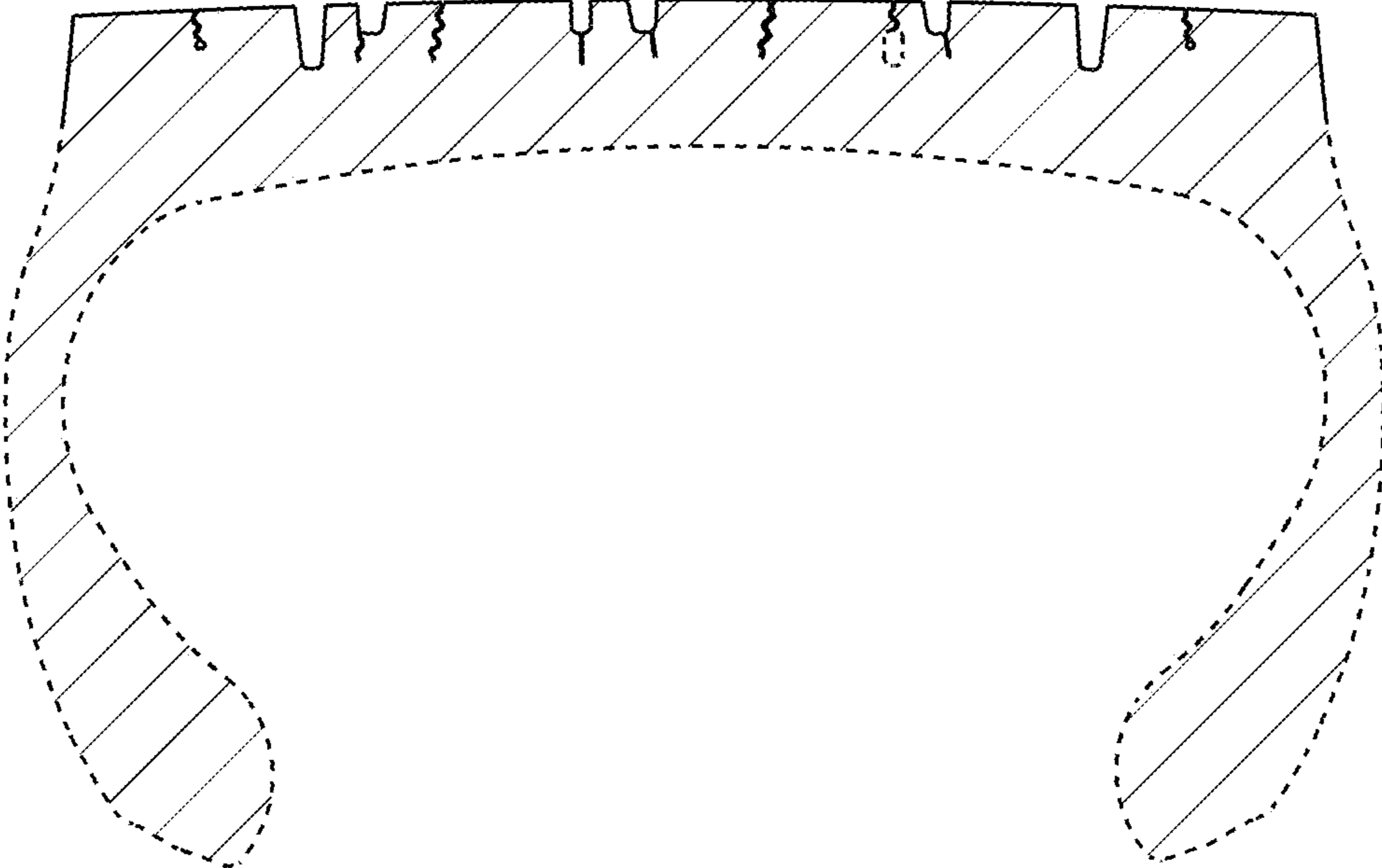

FIG. 4

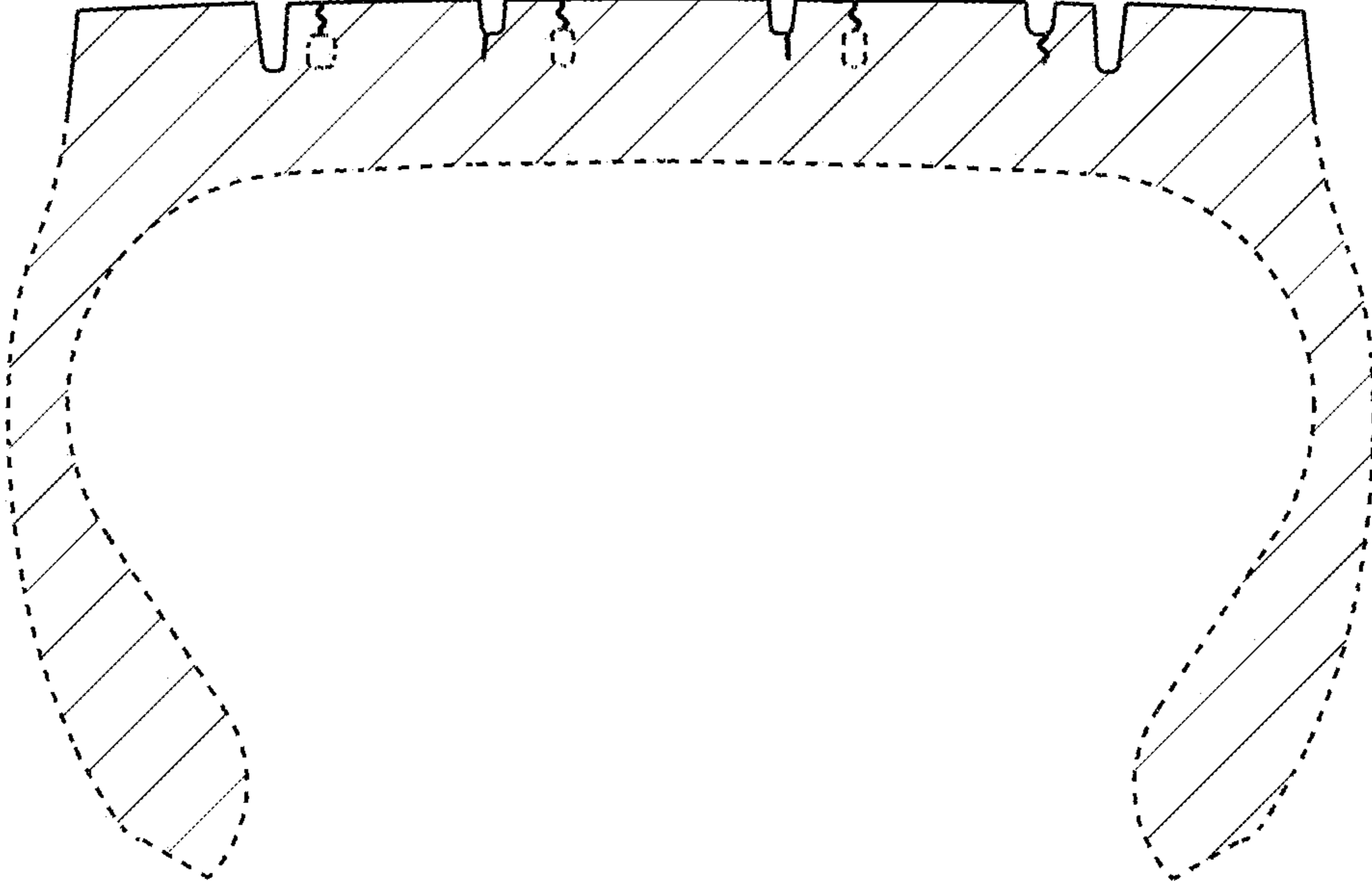

FIG. 5

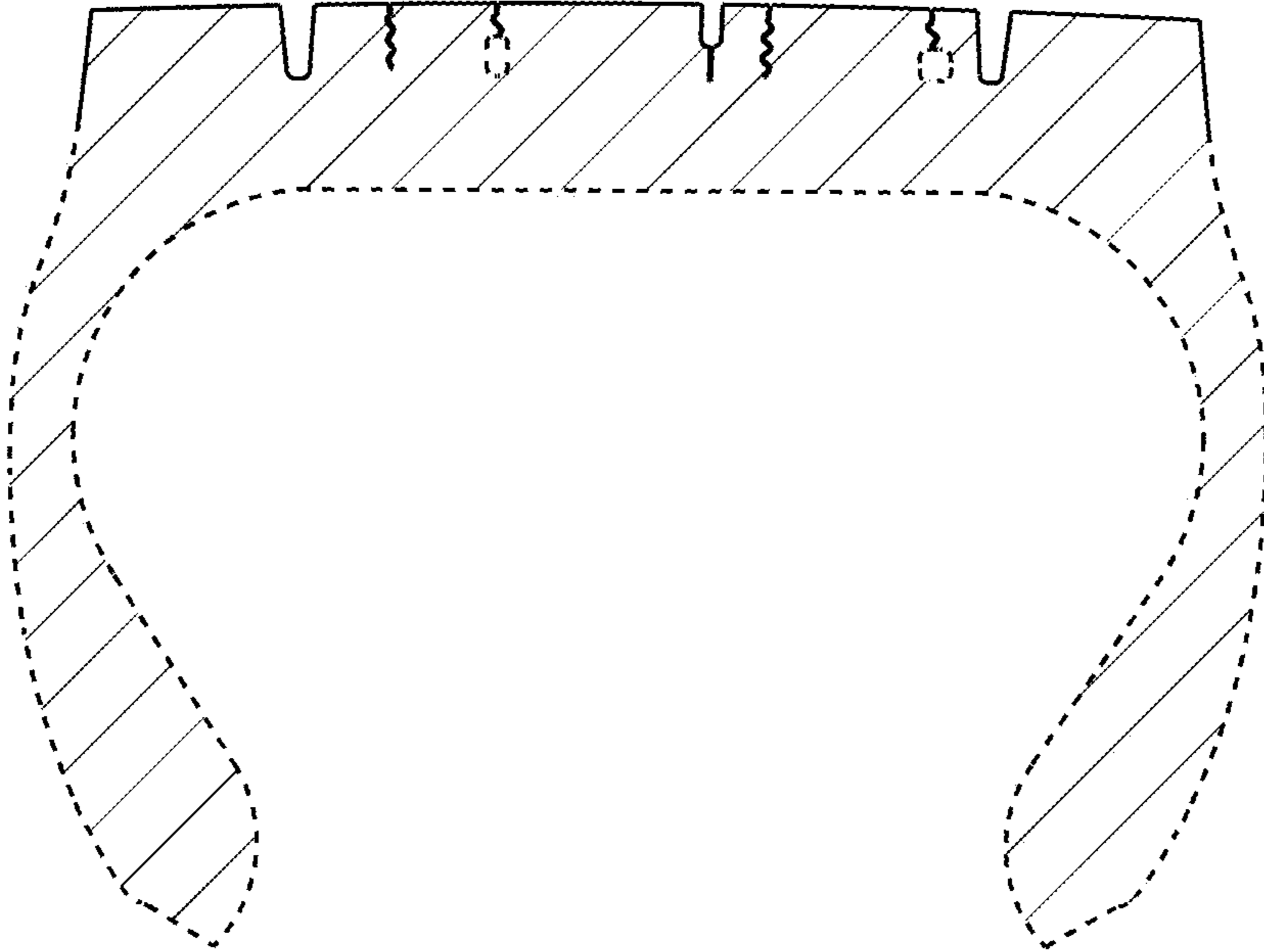

FIG. 6

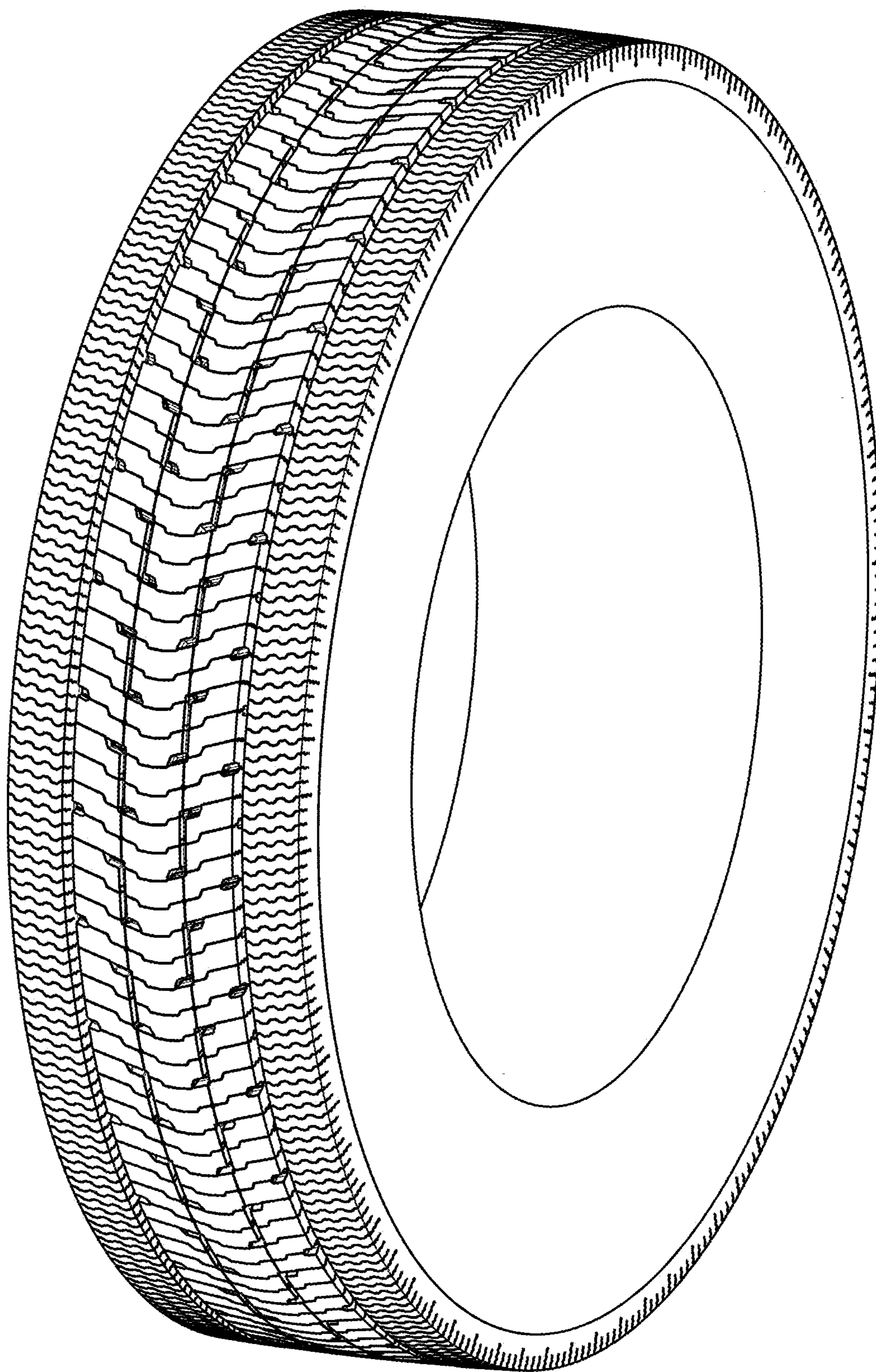

FIG. 7

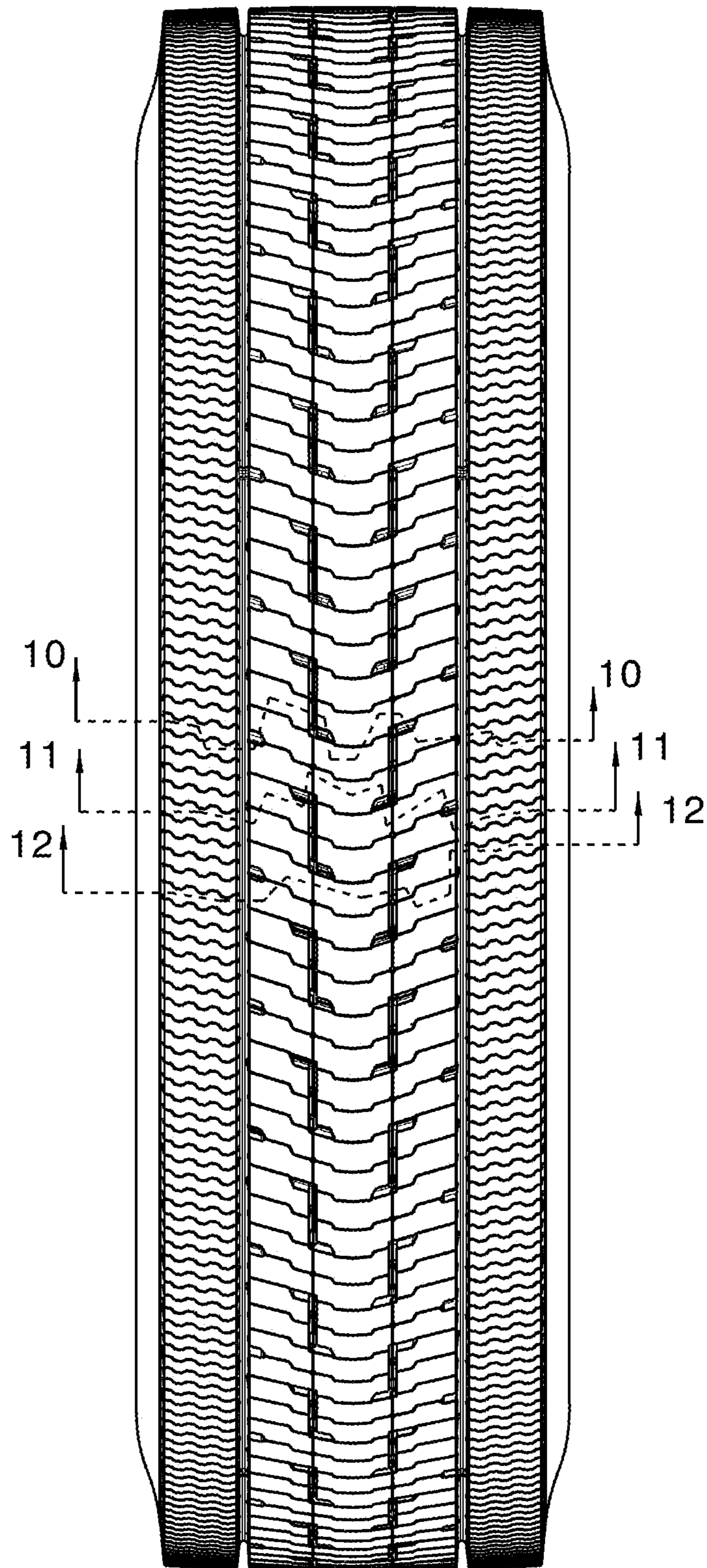

FIG. 8

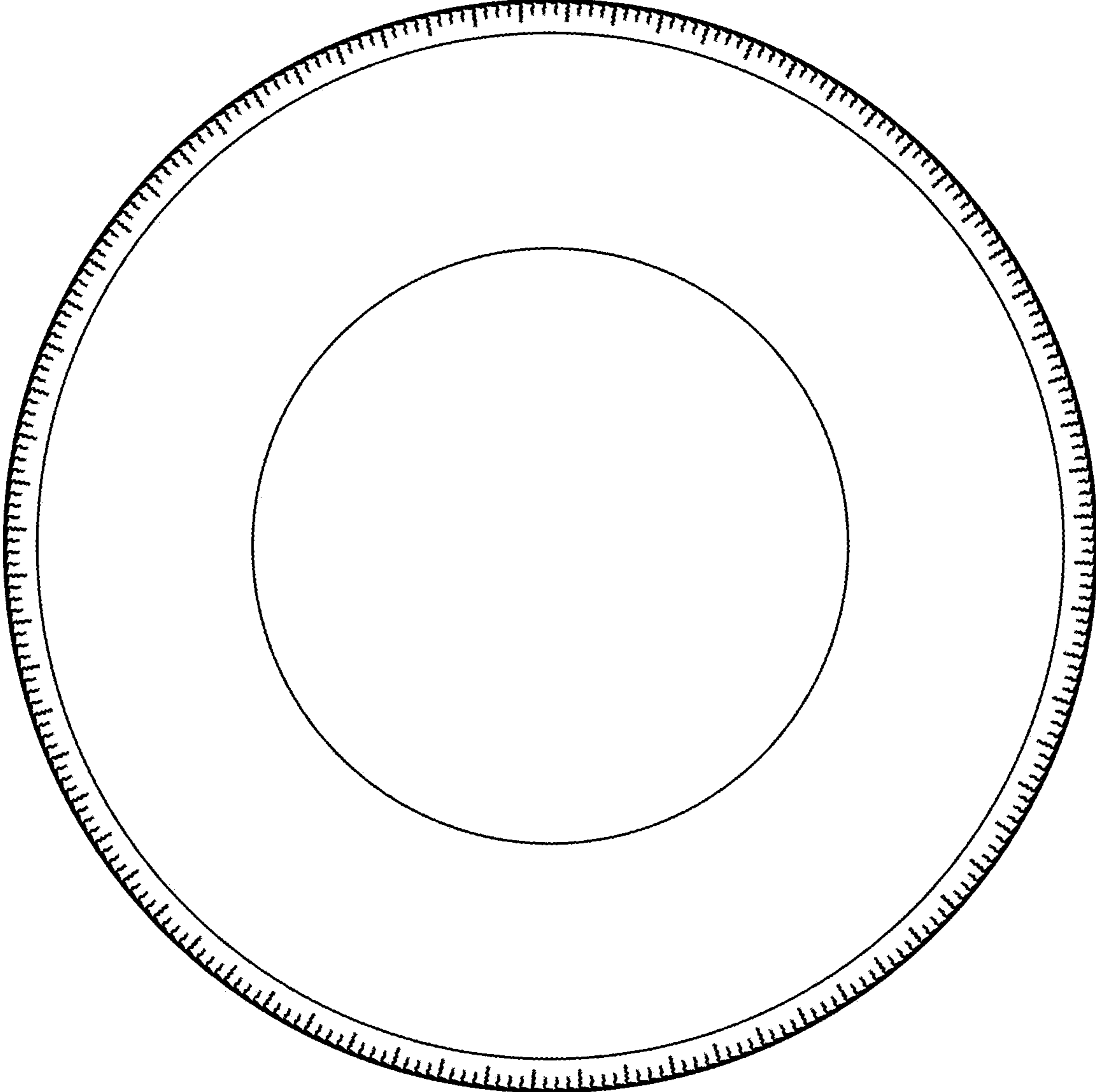

FIG. 9

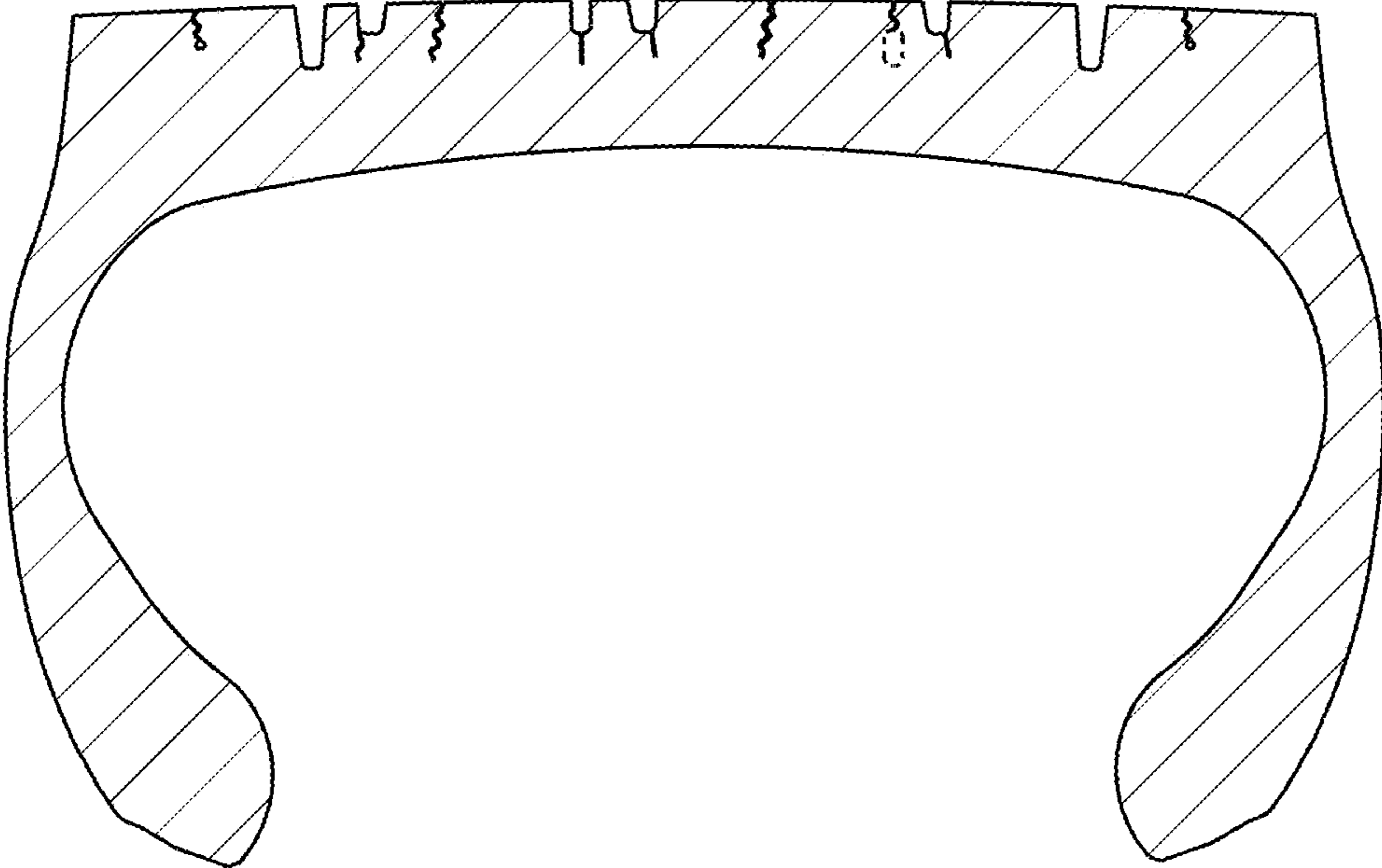

FIG. 10

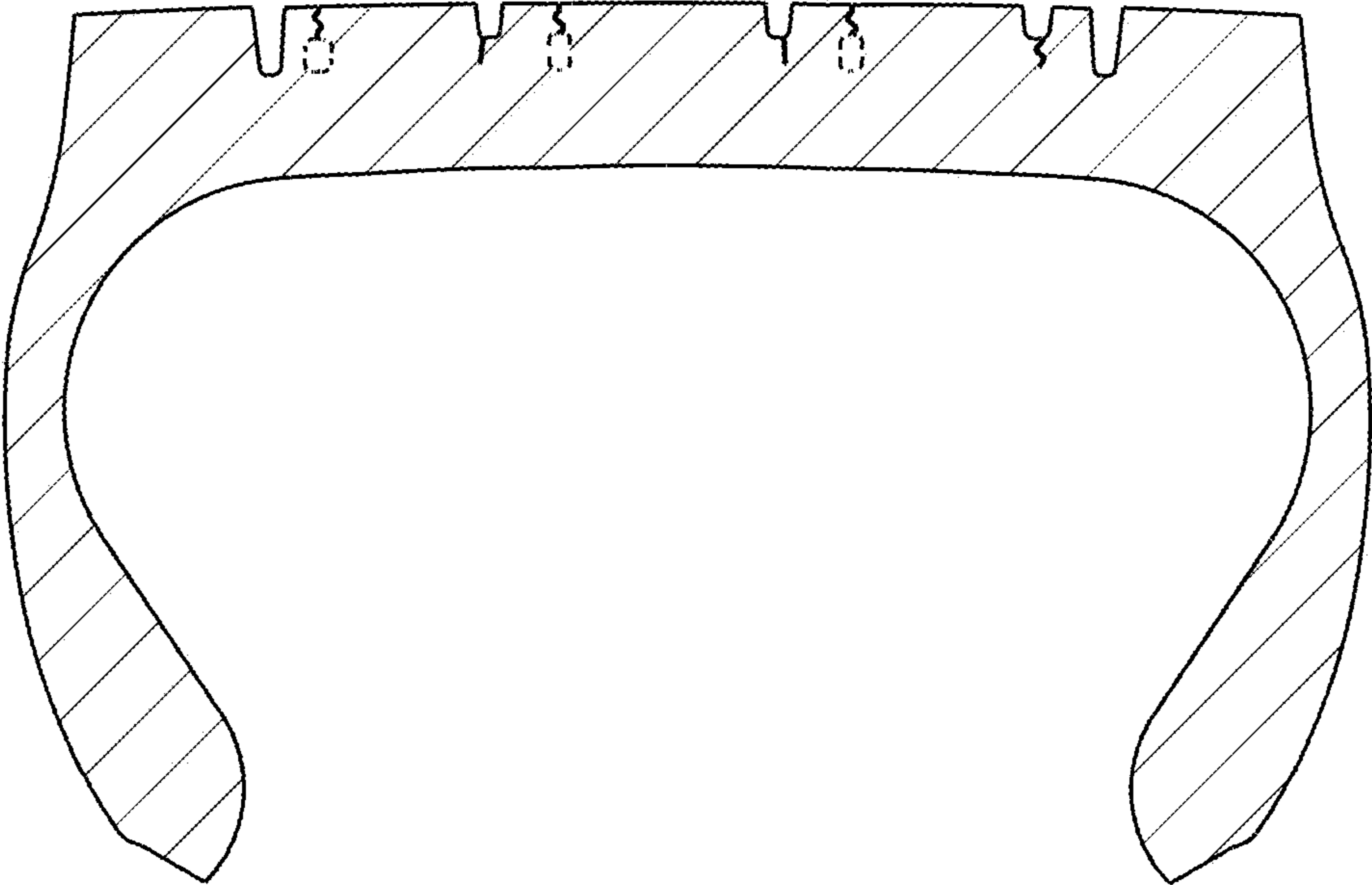

FIG. 11

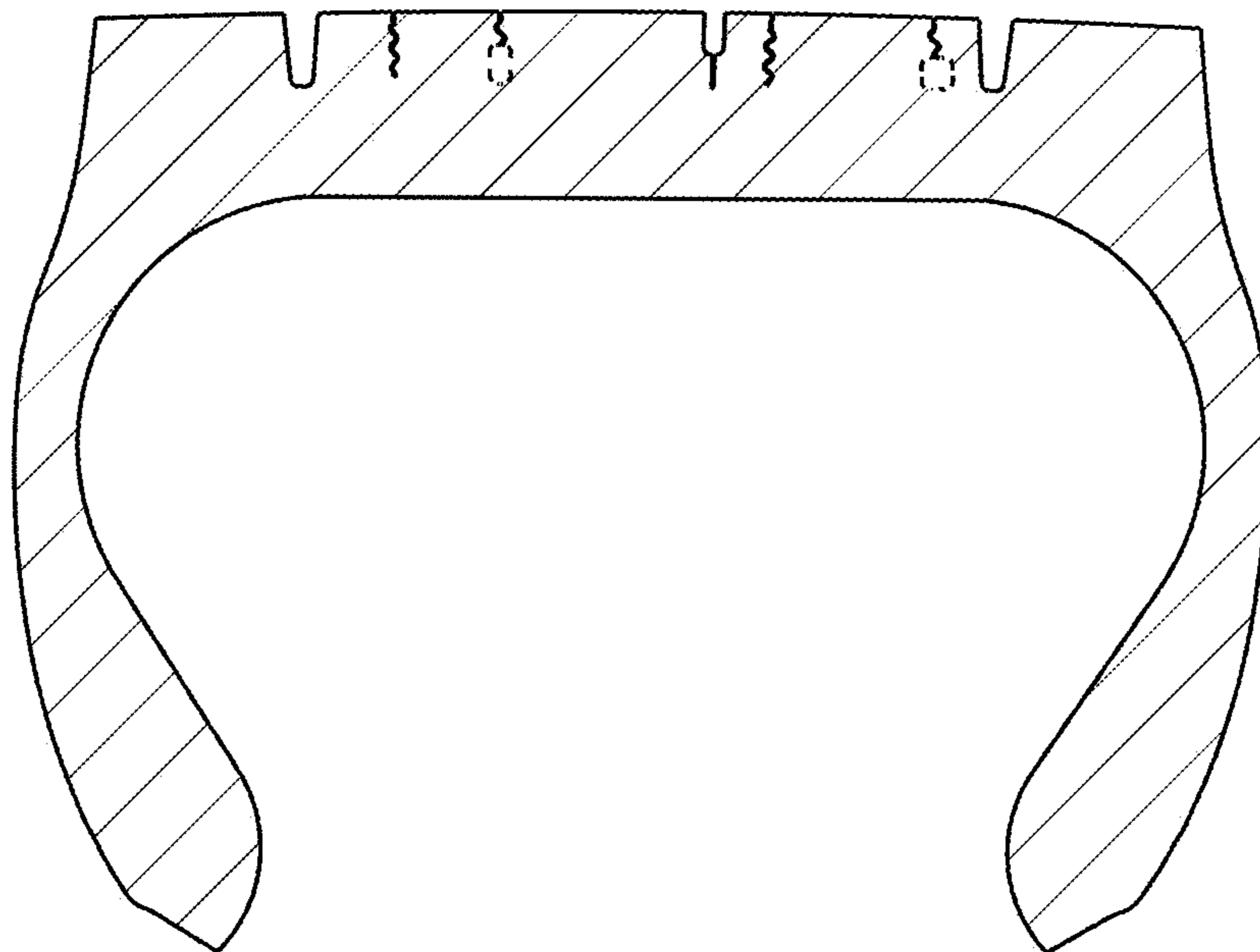

FIG. 12

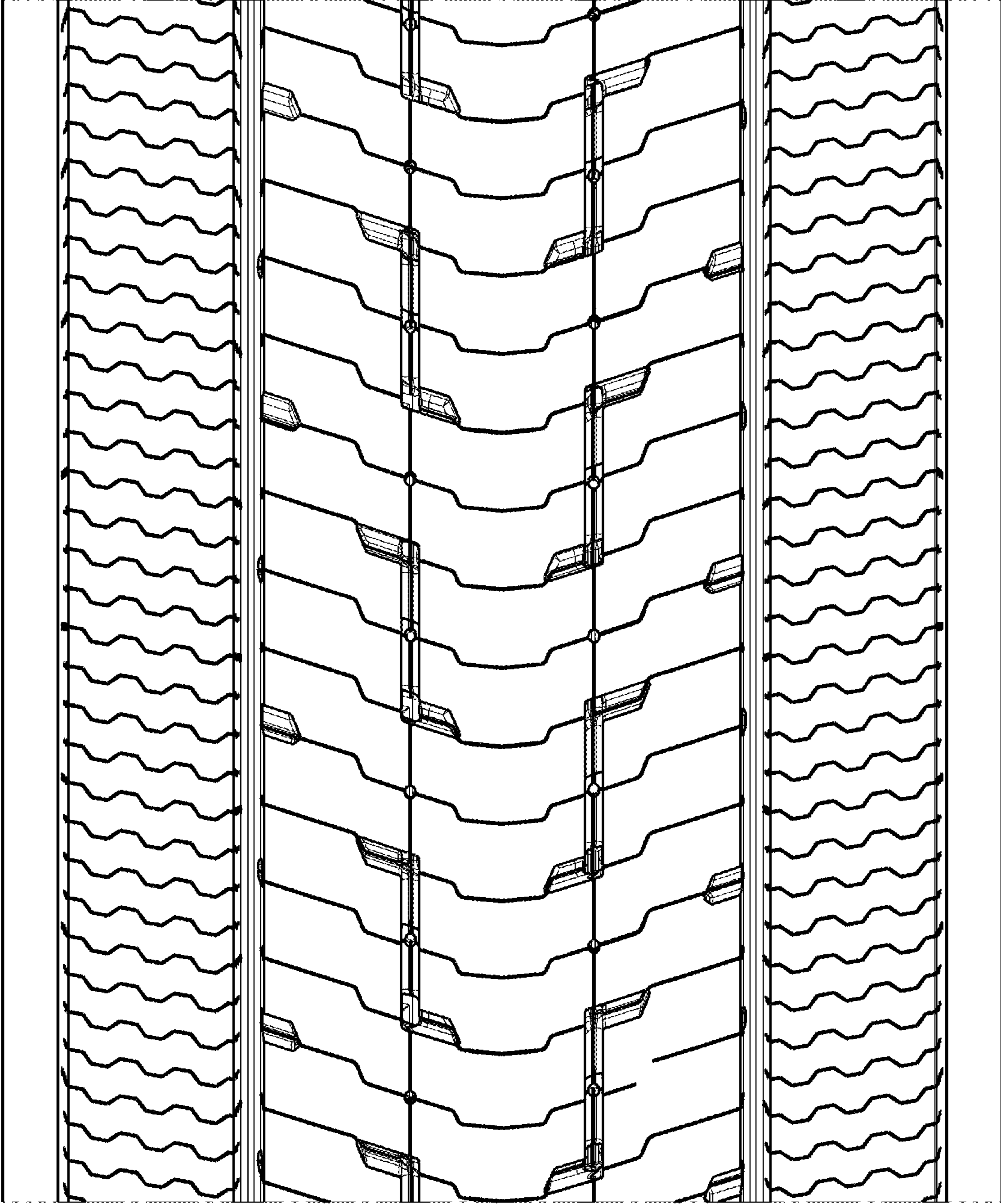

FIG. 13