



US00D883823S

(12) **United States Design Patent**
Nishiuchi et al.

(10) **Patent No.:** **US D883,823 S**

(45) **Date of Patent:** **** May 12, 2020**

(54) **PHOTOELECTRIC SENSOR**

(71) Applicant: **OMRON Corporation**, Kyoto-shi,
Kyoto (JP)

(72) Inventors: **Satoshi Nishiuchi**, Takatsuki (JP);
Heita Nada, Ritto (JP); **Nobuchika**
Takiguchi, Moriyama (JP); **Tetsuya**
Fukumoto, Kusatsu (JP)

(73) Assignee: **OMRON Corporation**, Kyoto (JP)

(**) Term: **15 Years**

(21) Appl. No.: **29/669,429**

(22) Filed: **Nov. 8, 2018**

(30) **Foreign Application Priority Data**

Jun. 28, 2018 (JP) 2018-014328

(51) **LOC (12) Cl.** **10-04**

(52) **U.S. Cl.**

USPC **D10/70; D10/106.3**

(58) **Field of Classification Search**

USPC D10/70, 106.3, 106.5; D13/165

CPC G01B 11/00; G01B 11/002; G01B 11/005;

G01B 11/007; G01B 11/02; G01B

11/022; G01B 11/024; G01B 11/026;

G01B 11/028; G01B 11/03; G01B 11/04;

G01B 11/043; G01B 11/046; G01B

11/06; G01B 11/0608; G01B 11/0616;

G01B 11/0625; G01B 11/0633; G01B

11/0641; G01B 11/065; G01B 11/0658;

G01B 11/0666; G01B 11/0675; G01B

11/0683; G01B 11/0691; G01B 11/08;

G01B 11/10; G01B 11/105; G01B 11/12;

G01B 11/14; G01B 11/16; G01B 11/161;

G01B 11/162; G01B 11/164; G01B

11/165; G01B 11/167; G01B 11/18;

G01B 11/20; G01B 11/22; G01B 11/24;

G01B 11/2408; G01B 11/2416; G01B

11/2425; G01B 11/2433; G01B 11/2441;

G01B 11/245; G01B 11/25; G01B

11/2504;

(Continued)

(56) **References Cited**

U.S. PATENT DOCUMENTS

5,740,693 A * 4/1998 Tanaka G01C 9/06

73/293

7,550,208 B2 * 6/2009 Ritz C03C 17/004

313/113

(Continued)

Primary Examiner — Antoine Duval Davis

(74) *Attorney, Agent, or Firm* — Capitol City TechLaw

(57) **CLAIM**

The ornamental design for a photoelectric sensor, as shown and described.

DESCRIPTION

FIG. 1 is a front, bottom, and left side perspective view of a photoelectric sensor showing our new design;

FIG. 2 is a front view thereof;

FIG. 3 is a rear view thereof;

FIG. 4 is a left side view thereof;

FIG. 5 is a right side view thereof;

FIG. 6 is a top view thereof;

FIG. 7 is a bottom view thereof;

FIG. 8 is an enlarged partial view of the left end of the photoelectric sensor as shown in FIG. 2;

FIG. 9 is an enlarged partial view thereof in an alternative state of use;

FIG. 10 is an enlarged partial view thereof in another alternative state of use;

FIG. 11 is an enlarged partial view thereof in another alternative state of use; and,

FIG. 12 is an enlarged partial view thereof in another alternative state of use.

The broken lines in the figures show portions of the photoelectric sensor that form no part of the claimed design.

1 Claim, 9 Drawing Sheets

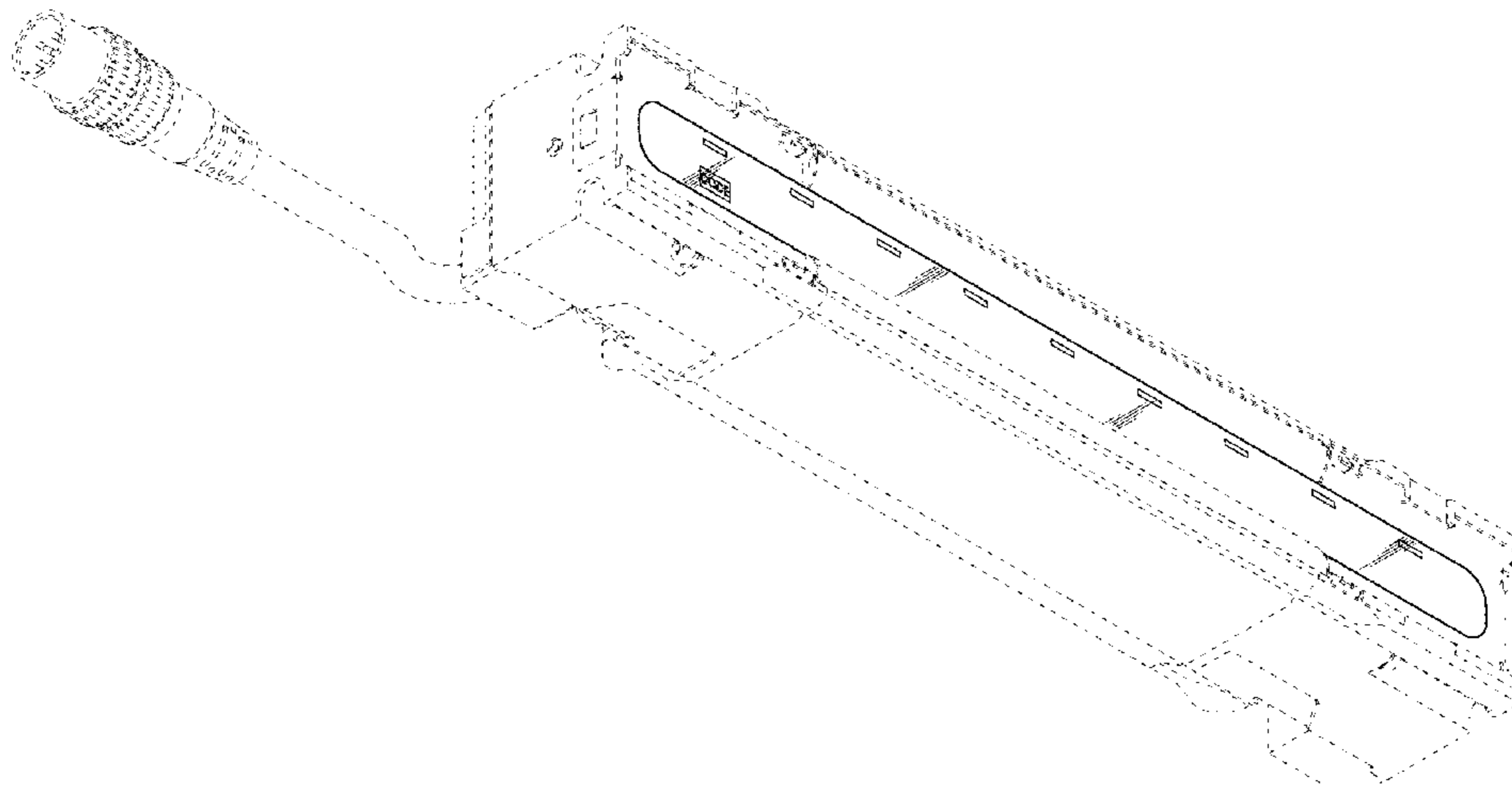

(58) **Field of Classification Search**

CPC G01B 11/2509; G01B 11/2513; G01B 11/2518; G01B 11/2522; G01B 11/2527; G01B 11/2531; G01B 11/2536; G01B 11/254; G01B 11/2545; G01B 11/255; G01B 11/26; G01B 11/27; G01B 11/272; G01B 11/275; G01B 11/2755; G01B 11/28; G01B 11/285; G01B 11/30; G01B 11/303; G01B 11/306; G01J 1/00; G01J 1/02; G01J 1/0204; G01J 1/0209; G01J 1/0214; G01J 1/0219; G01J 1/0223; G01J 1/0228; G01J 1/0233; G01J 1/0238; G01J 1/0242; G01J 1/0247; G01J 1/0252; G01J 2001/0257; G01J 2001/0261; G01J 1/0266; G01J 1/0271; G01J 2001/028; G01J 2001/0285; G01J 1/029; G01J 1/0295; G01J 1/18; G01J 1/16; G01V 8/00; G01V 8/005; G01V 8/02; G01V

8/10; G01V 8/12; G01V 8/14; G01V 8/16; G01V 8/18; G01V 8/20; G01V 8/22; G01V 8/24; G01V 8/26; H03K 2014/9634; H03K 17/9629; H03K 17/9631; H03K 17/9636; H03K 17/9638; H03K 2017/9634

See application file for complete search history.

(56)

References Cited

U.S. PATENT DOCUMENTS

D625,632 S * 10/2010 Takahara D10/70
D753,519 S * 4/2016 Takenaka G01C 9/06
D10/106.1
D769,745 S * 10/2016 Takenaka C03C 17/004
D10/70

* cited by examiner

Fig. 1

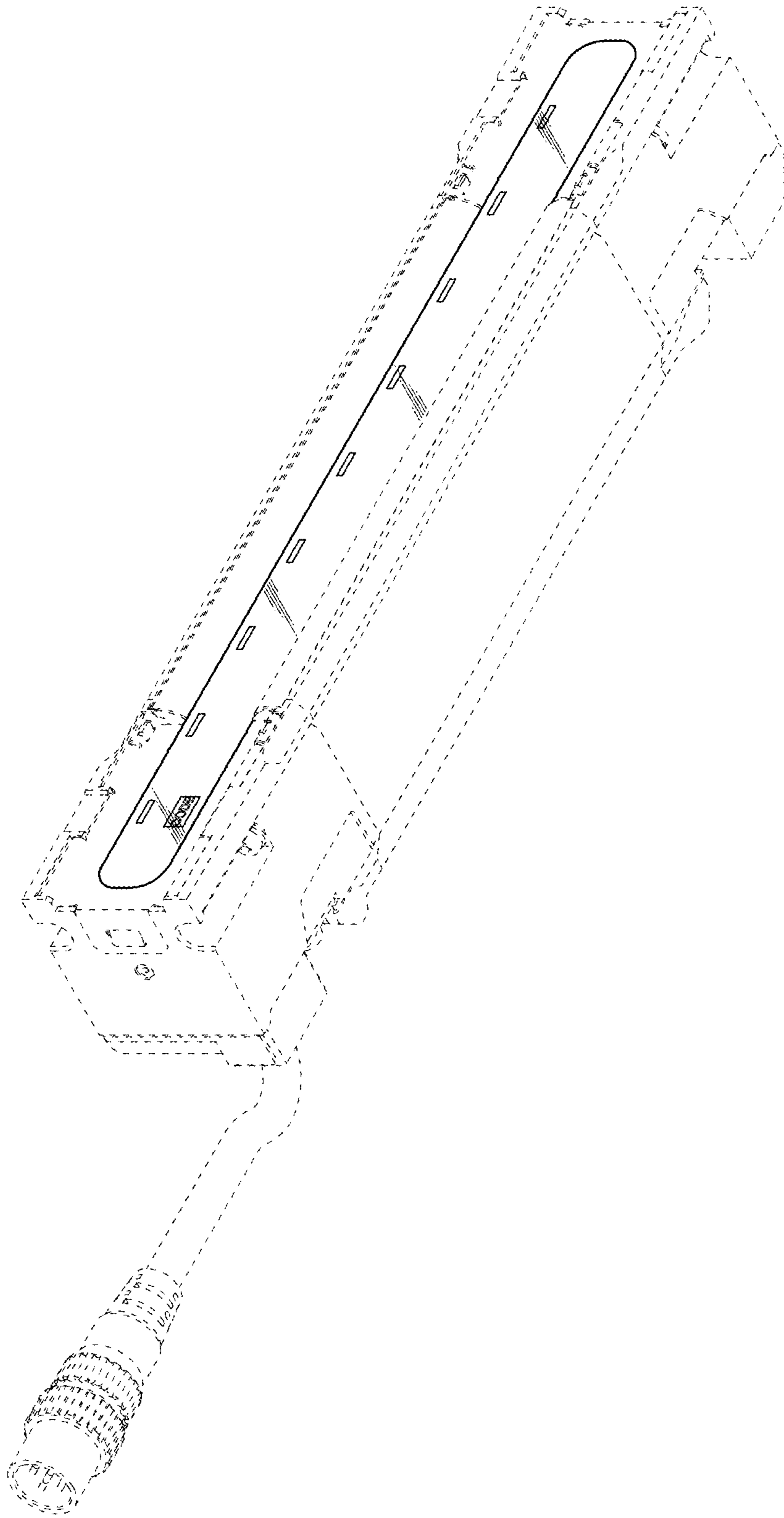

Fig. 2

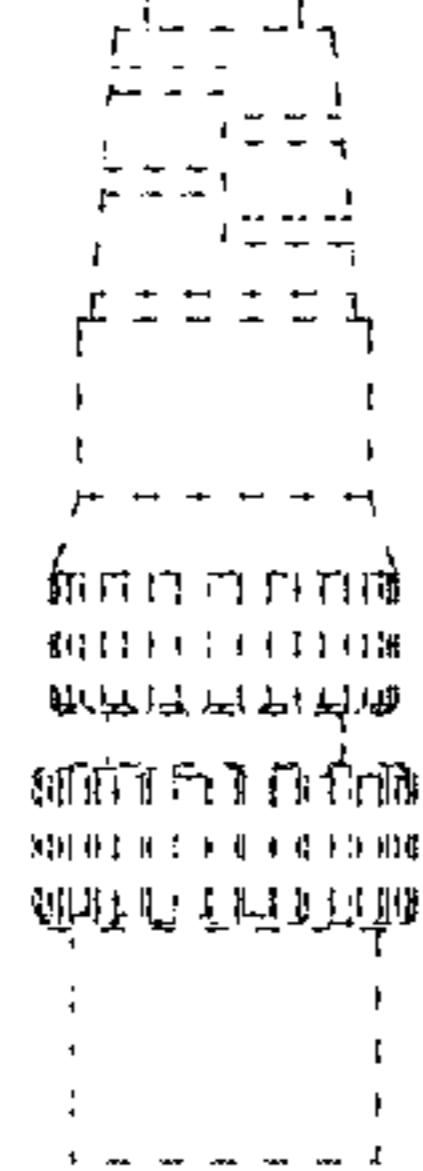
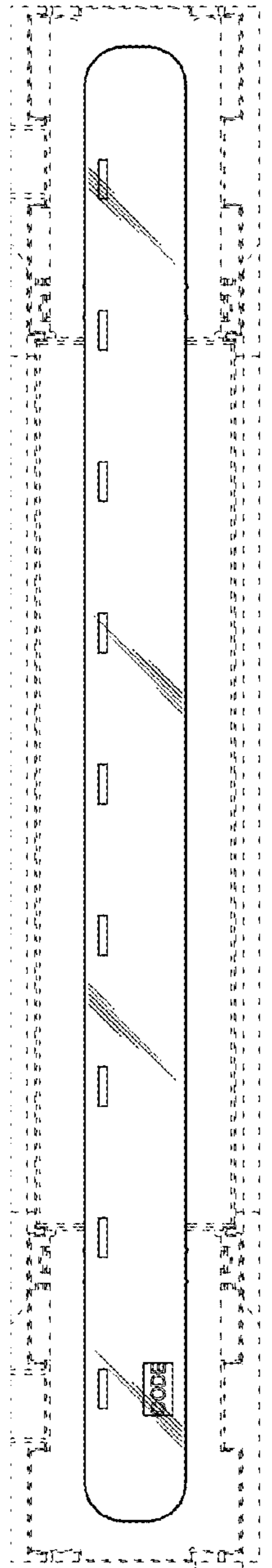
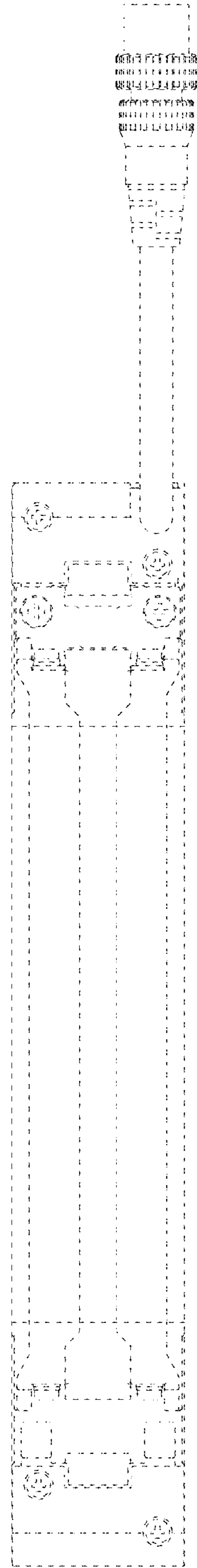

Fig. 3



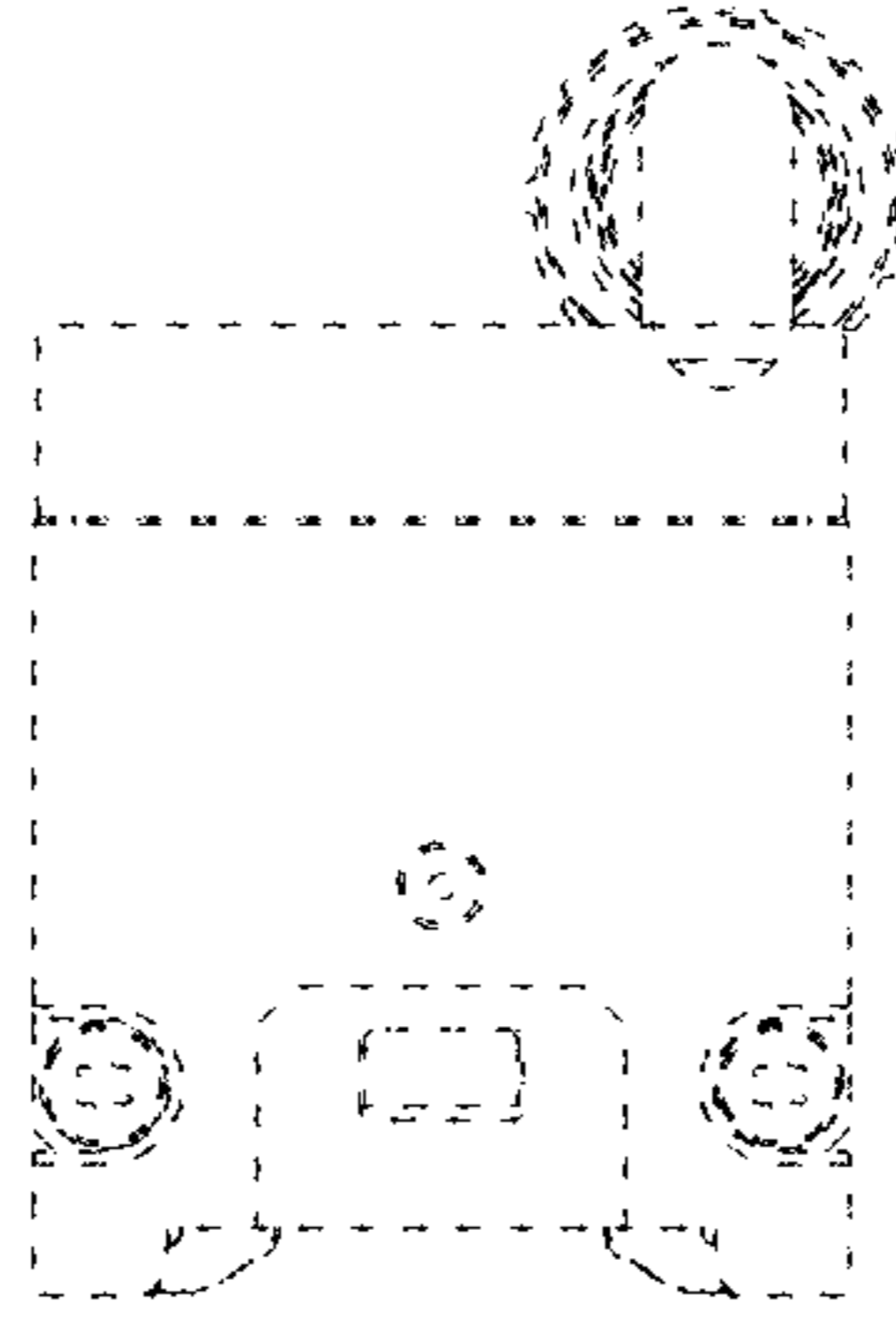

Fig. 5

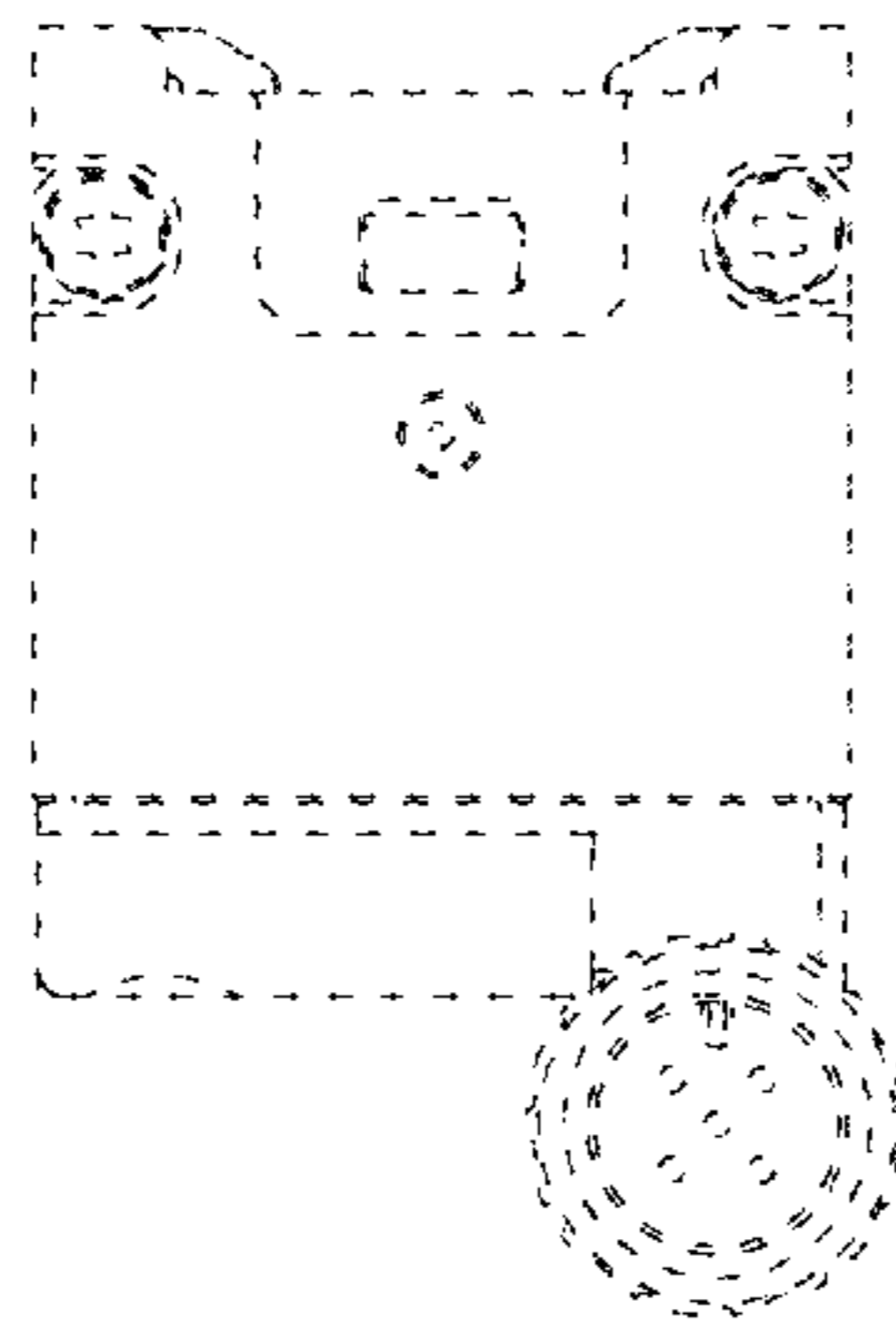

Fig. 4

Fig. 6

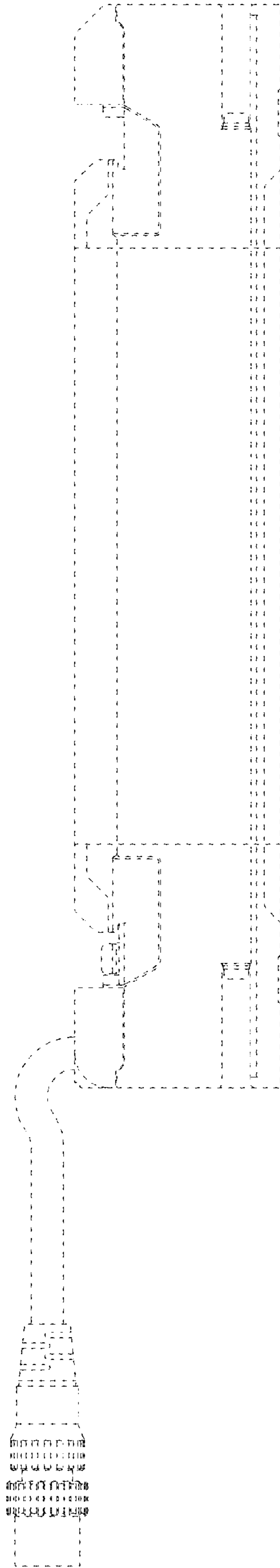
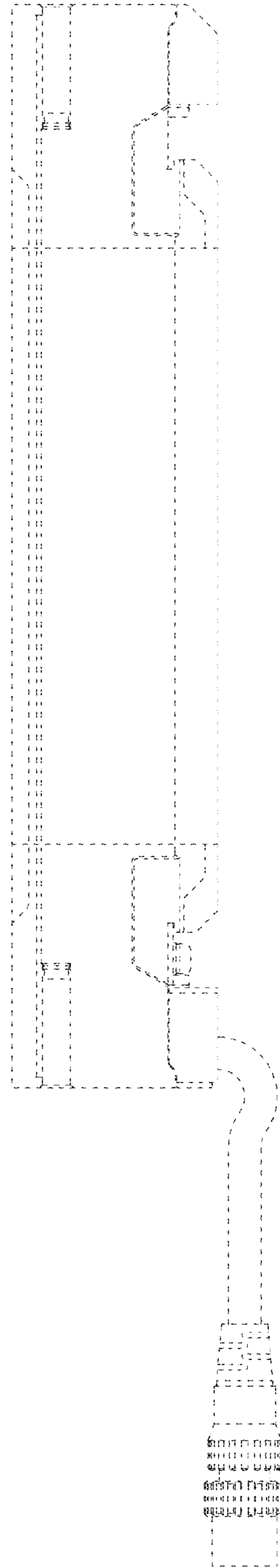

Fig. 7



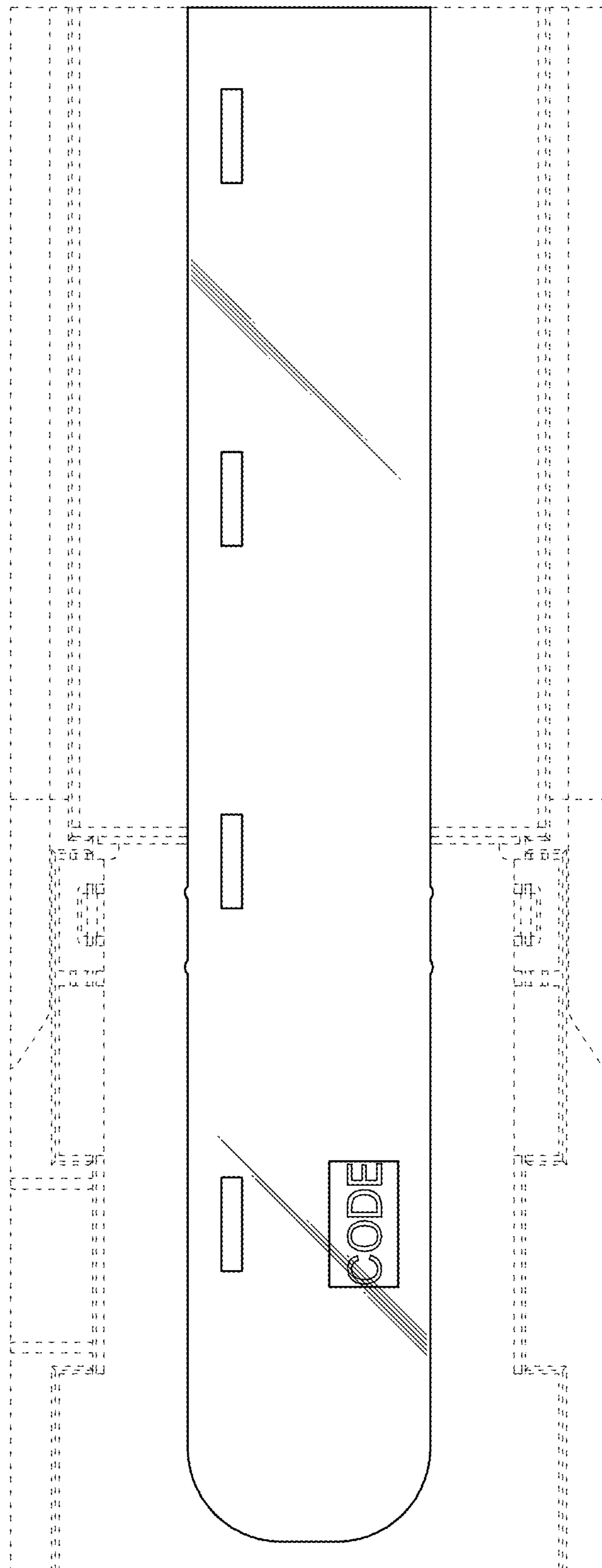

Fig. 8

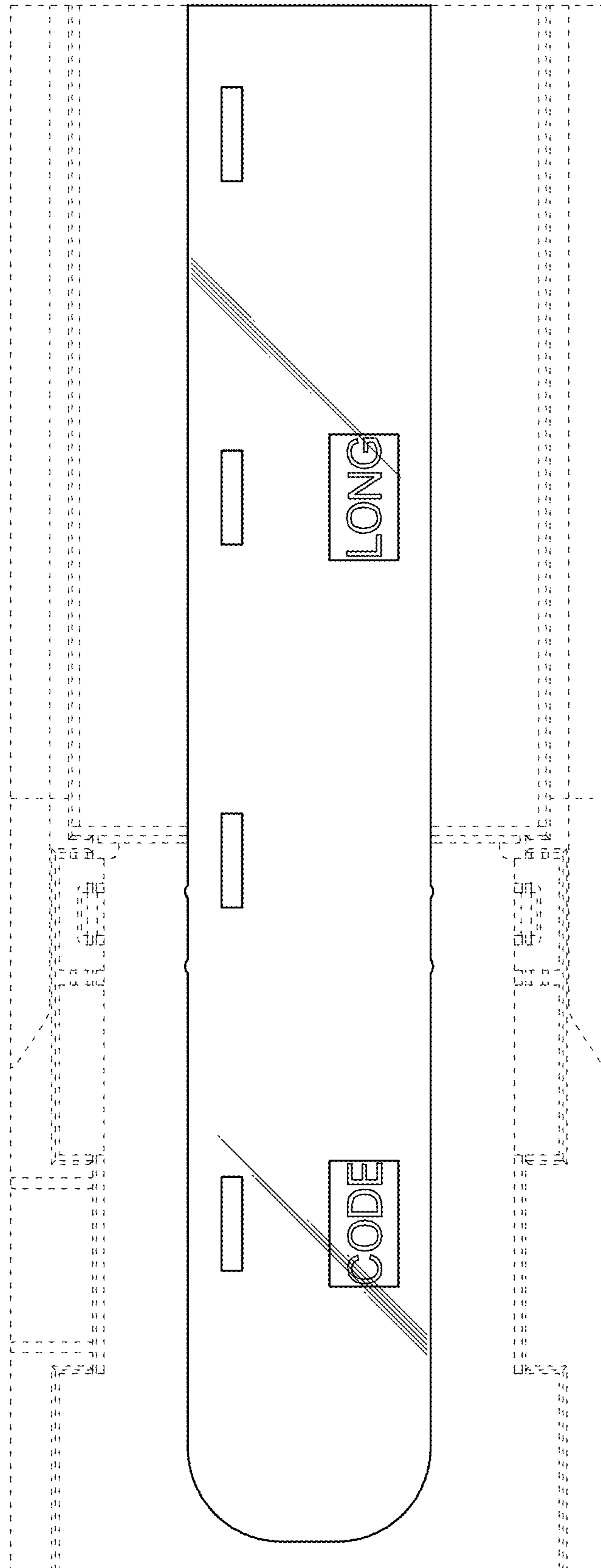

Fig. 9

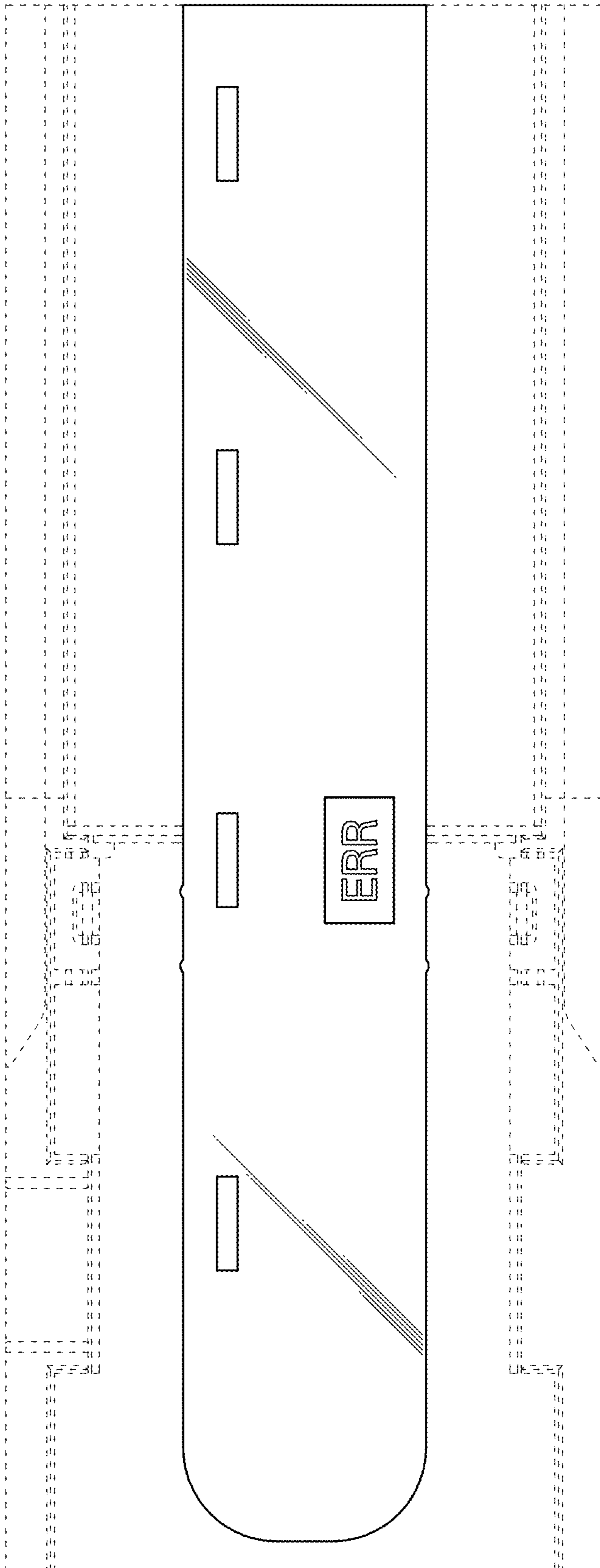

Fig. 10

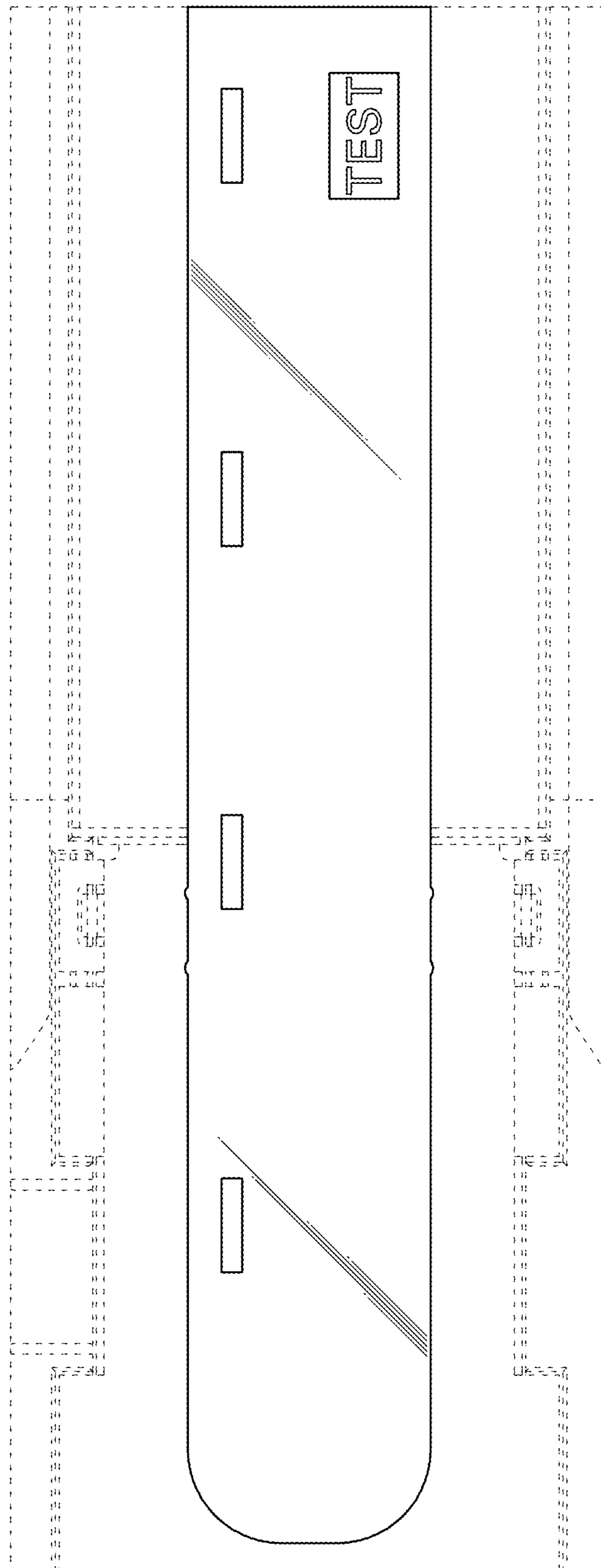

Fig. 11

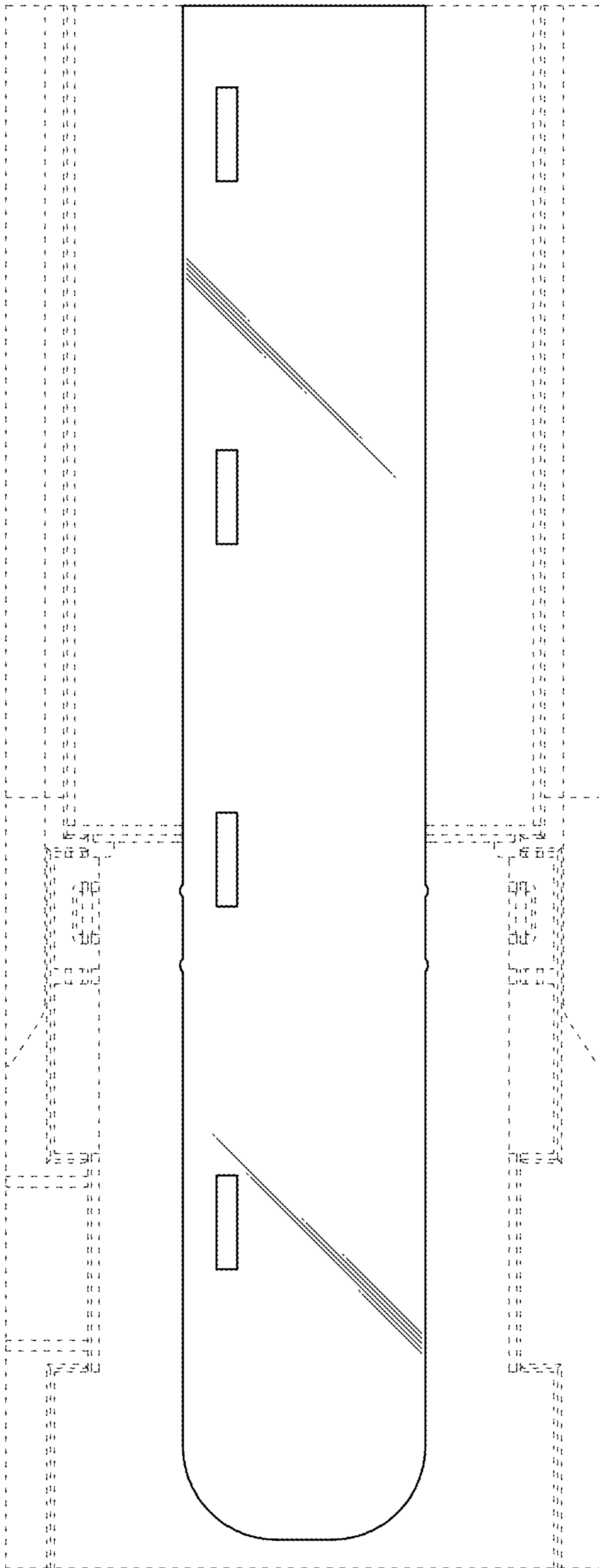

Fig. 12