



US00D883814S

(12) **United States Design Patent**  
**Flachsbart et al.**

(10) **Patent No.:** **US D883,814 S**

(45) **Date of Patent:** **\*\* May 12, 2020**

(54) **COMPONENT HOUSING FOR WATER  
DETECTION ASSEMBLY**

(71) Applicant: **HS Labs, Inc.**, San Antonio, TX (US)

(72) Inventors: **Matthew T. Flachsbart**, Grapevine, TX  
(US); **Benjamin D. Ethington**, Fruit  
Heights, UT (US)

(73) Assignee: **HS Labs, Inc.**, San Antonio, TX (US)

(\*\*) Term: **15 Years**

(21) Appl. No.: **29/683,492**

(22) Filed: **Mar. 13, 2019**

**Related U.S. Application Data**

(62) Division of application No. 29/614,844, filed on Aug.  
23, 2017, now Pat. No. Des. 847,681.

(51) **LOC (12) Cl.** ..... **10-04**

(52) **U.S. Cl.**

USPC ..... **D10/49**; D10/96; D10/99; D10/101

(58) **Field of Classification Search**

USPC ..... D10/49, 96, 99, 101; D13/162

CPC ..... G08B 21/20; G08B 21/18; G08B 21/02;

G08B 21/182; G08B 3/00; G08B 19/00;

G08B 19/02; G01M 3/16; G01M 3/40;

G01M 3/38; G01N 27/048; G01N

33/0031; G01N 33/0032; G01D 7/00;

G01D 11/24; G01D 11/245; G01F 1/00

See application file for complete search history.

(56) **References Cited**

U.S. PATENT DOCUMENTS

4,297,686 A	10/1981	Tom	
5,386,893 A	2/1995	Feigel	
D852,076 S *	6/2019	Bob	..... D10/101

\* cited by examiner

*Primary Examiner* — Antoine Duval Davis

(74) *Attorney, Agent, or Firm* — Pizarro Allen PC

(57) **CLAIM**

The ornamental design for a component housing for water  
detection assembly, substantially as shown and described.

**DESCRIPTION**

FIG. 1 is a front perspective view of a component housing  
for water detection assembly;

FIG. 2 is a back perspective view of the component housing;

FIG. 3 is a back perspective view of the component housing;

FIG. 4 is a left side elevational view of the component

housing;

FIG. 5 is a right side elevational view of the component

housing;

FIG. 6 is a front elevational view of the component housing;

FIG. 7 is a back elevational view of the component housing;

FIG. 8 is a top plan view of the component housing; and,

FIG. 9 is a bottom plan view of the component housing.

Phantom lines, where utilized, are for illustrative purposes  
only and form no part of the claimed design.

**1 Claim, 6 Drawing Sheets**

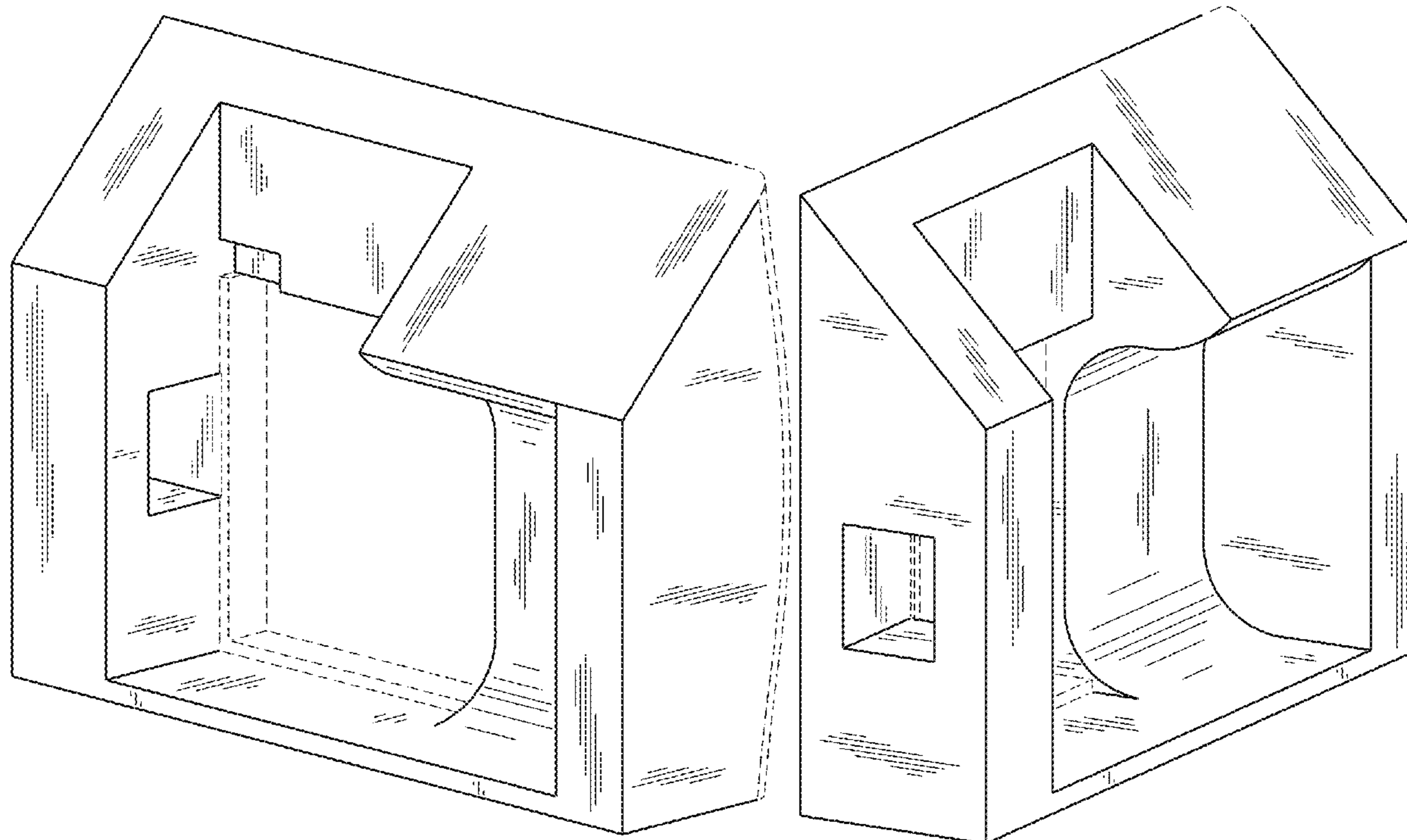

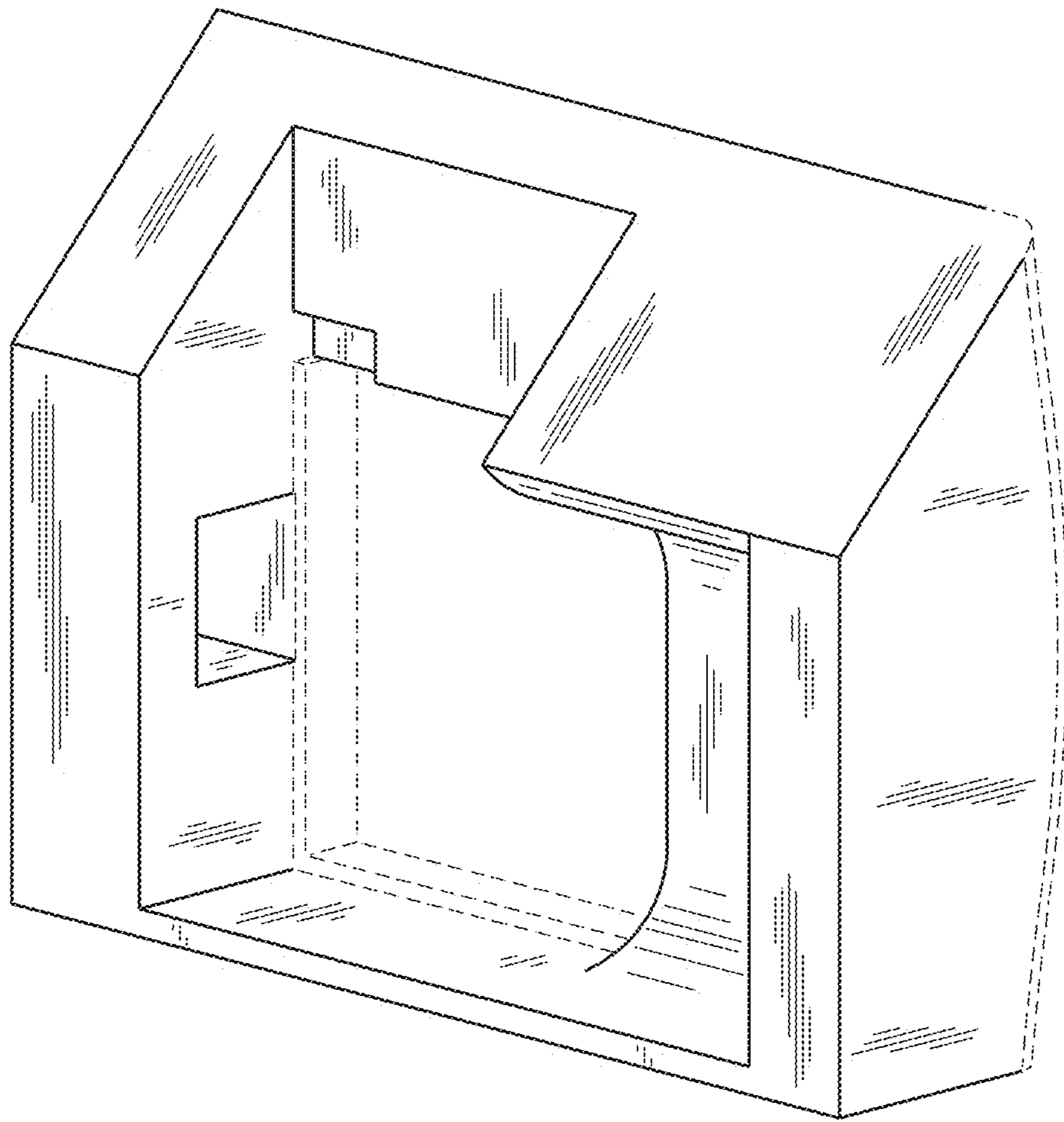

FIG. 1

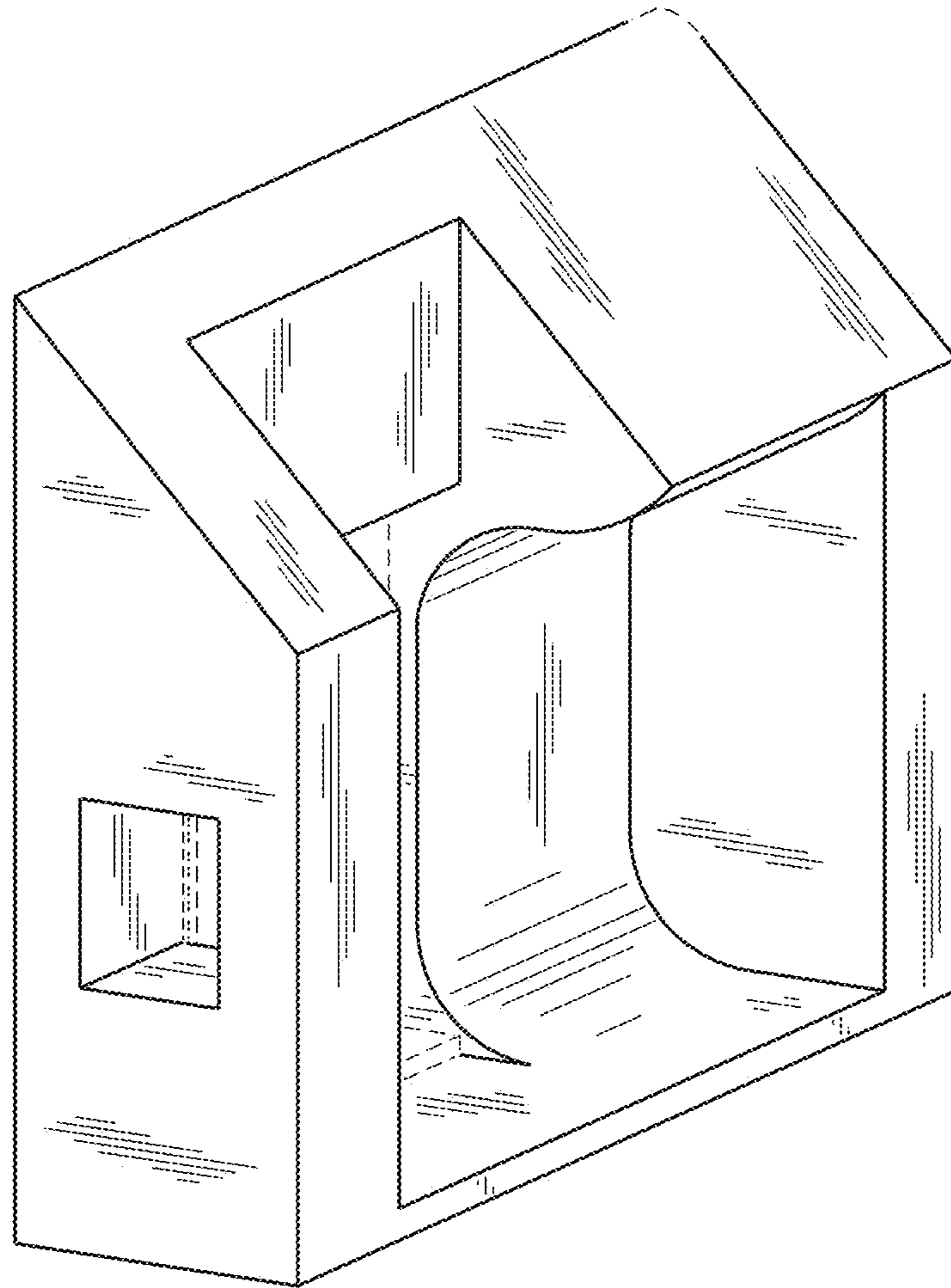

FIG. 2

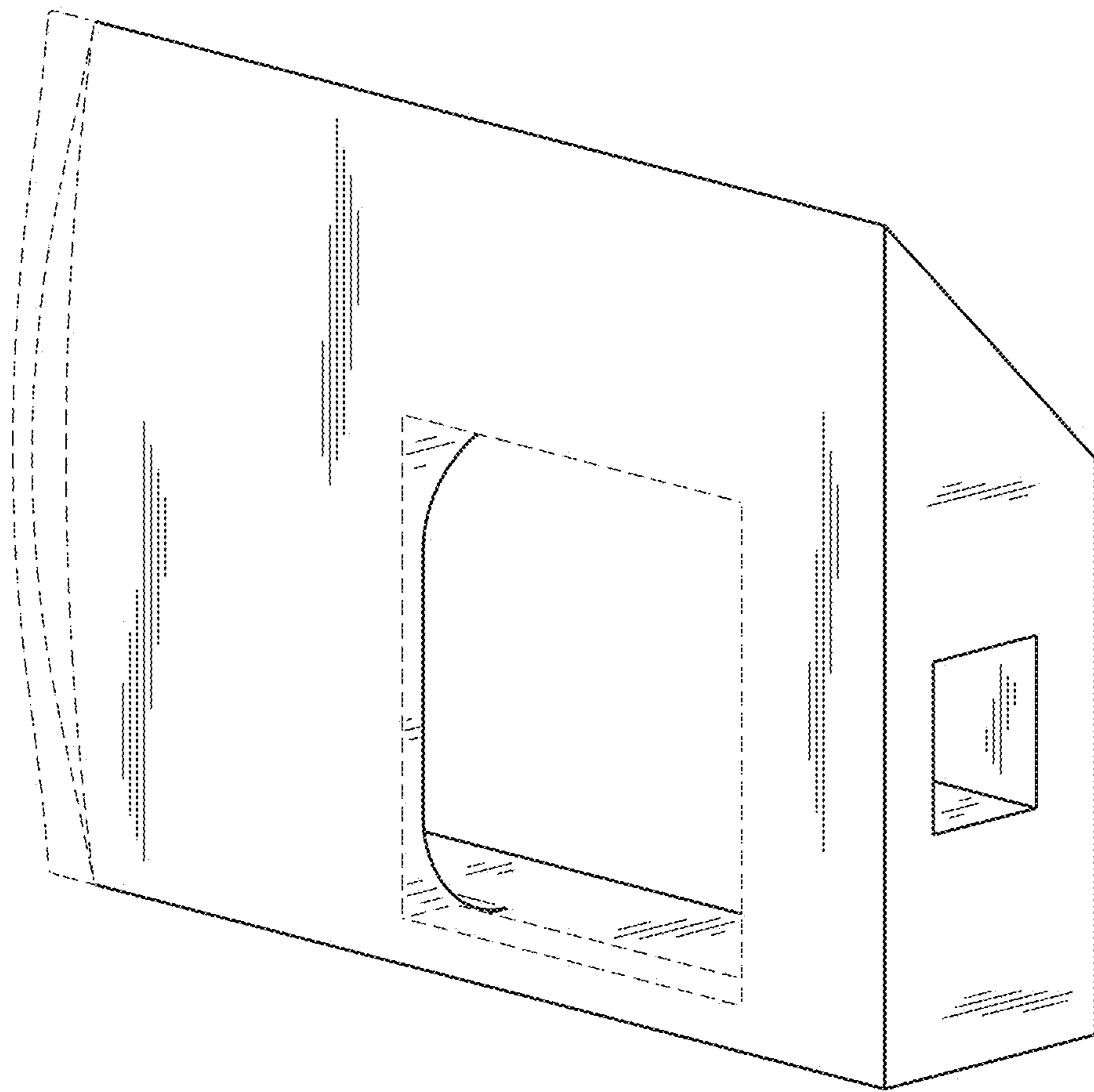

FIG. 3

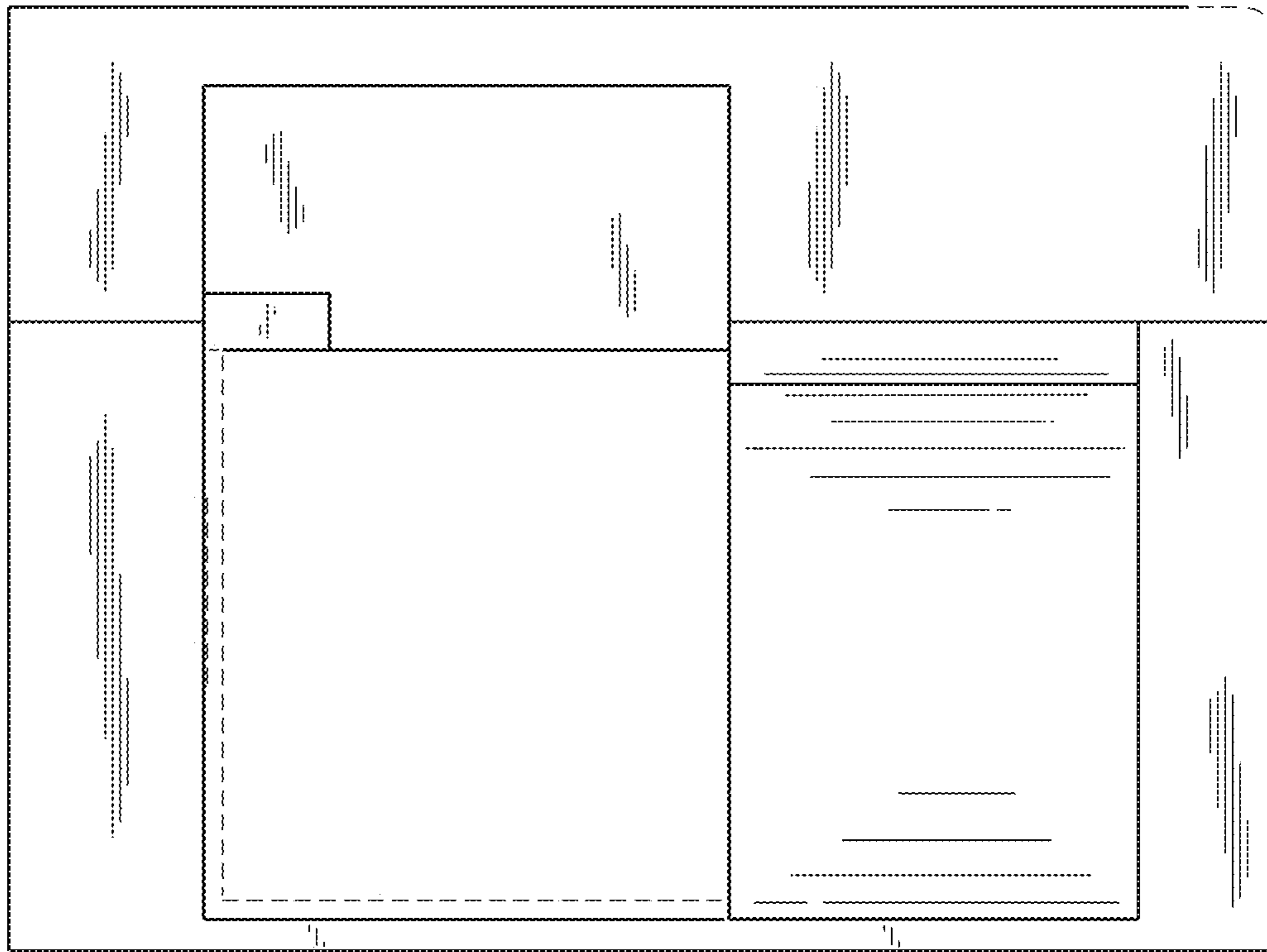

FIG. 4

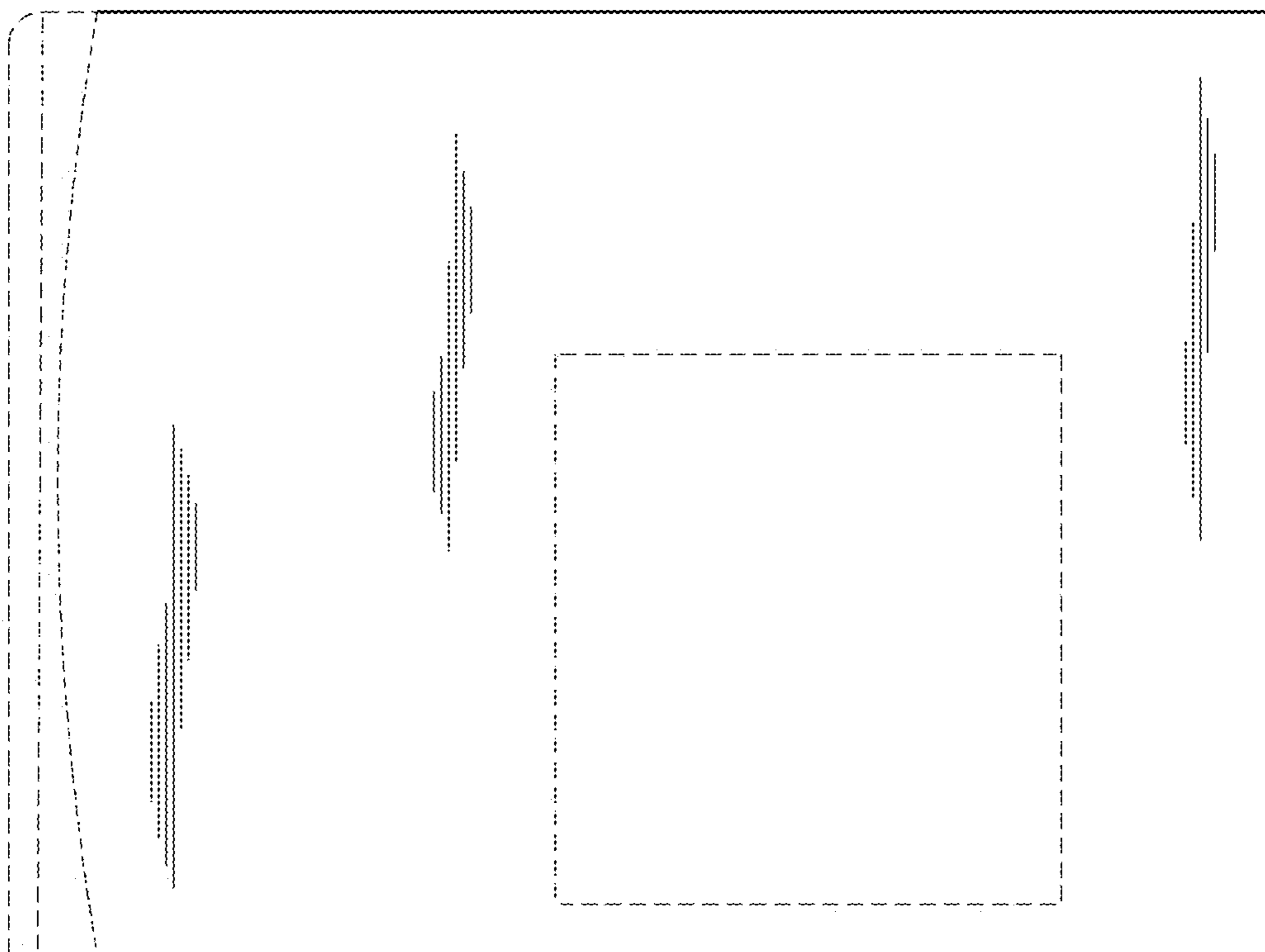

FIG. 5

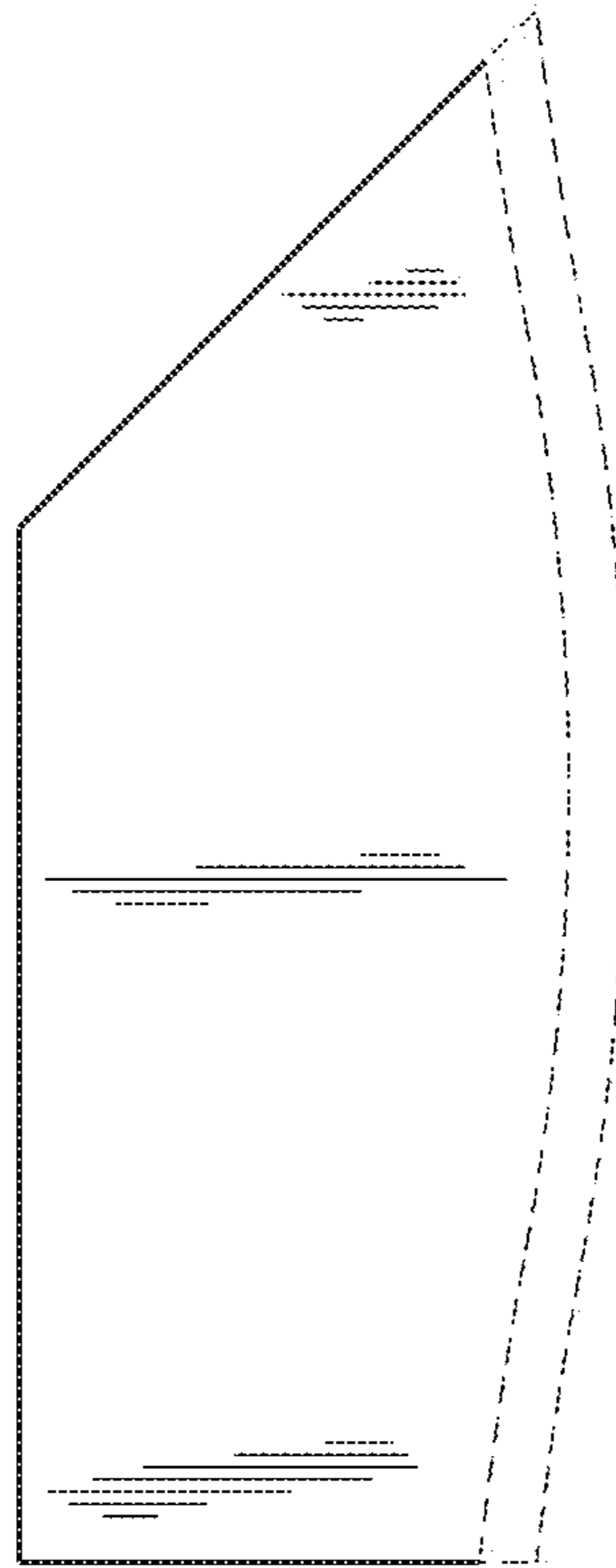

FIG. 6

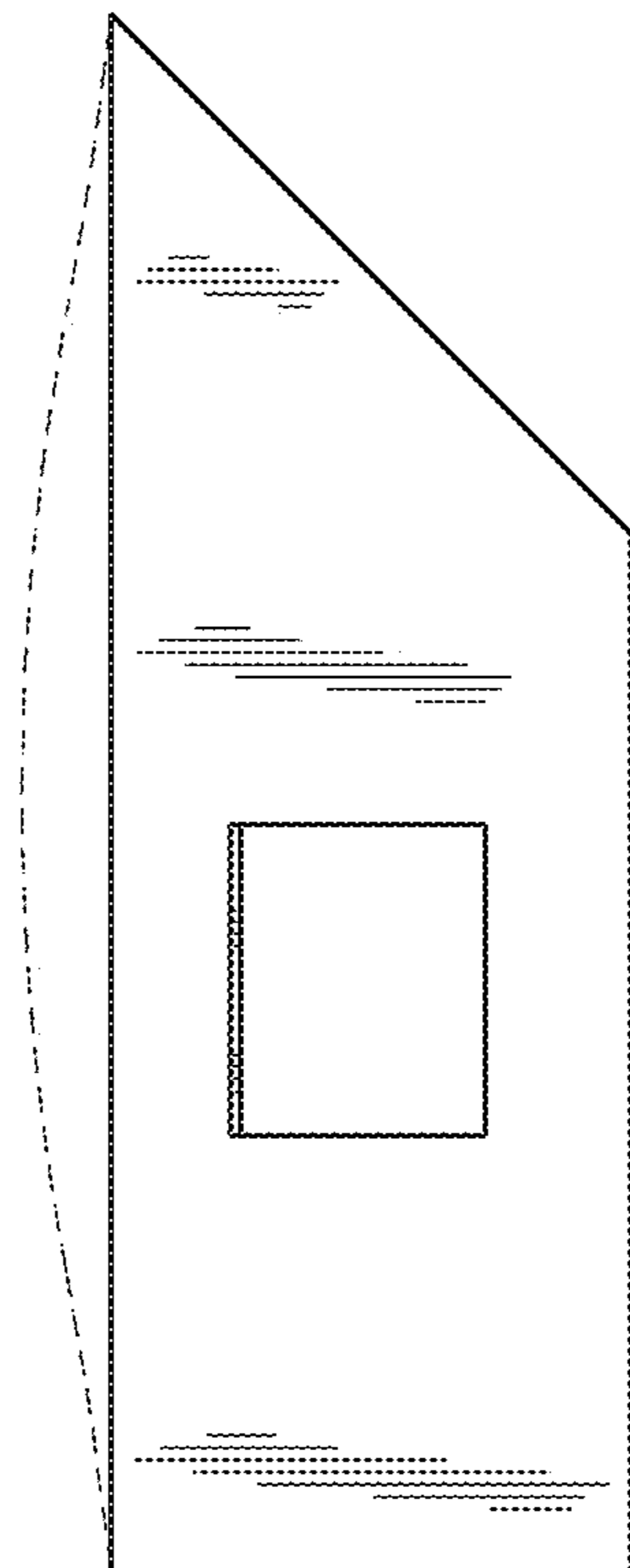

FIG. 7

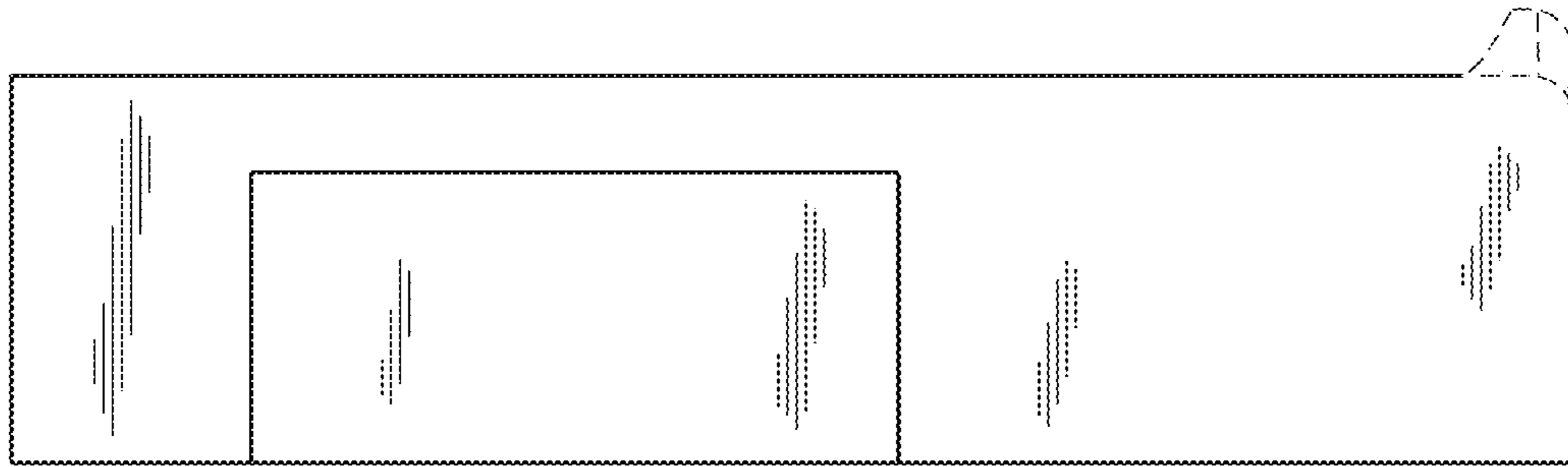

FIG. 8

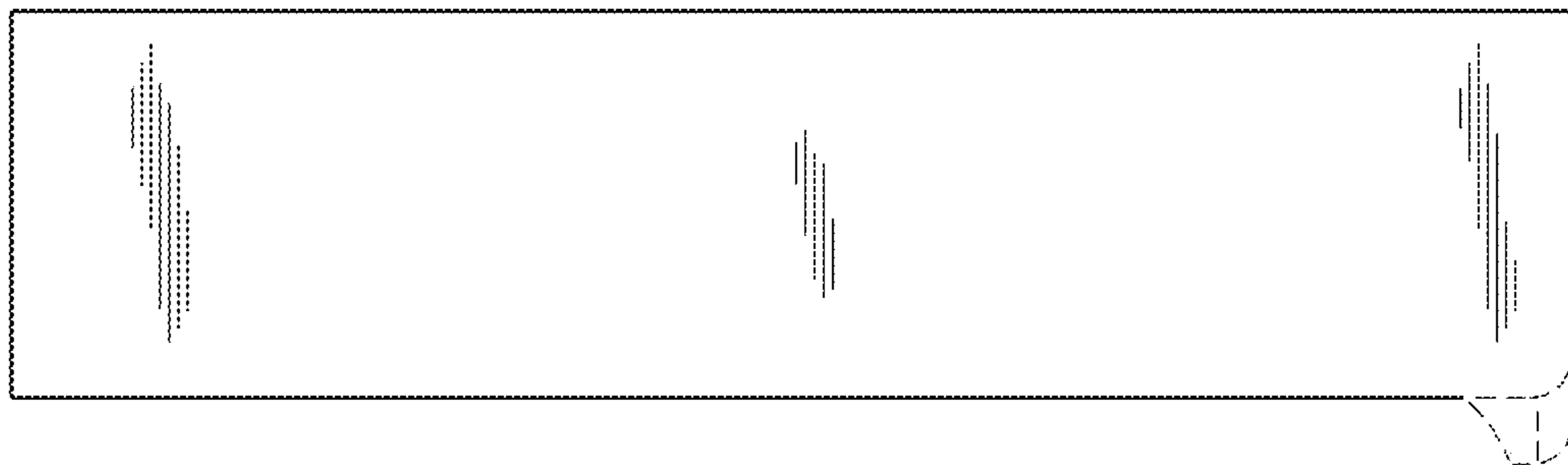

FIG. 9