



US00D883787S

(12) **United States Design Patent** (10) **Patent No.:** **US D883,787 S**
Marcano (45) **Date of Patent:** **** May 12, 2020**

(54) **OVER THE COUNTER MEDICINAL CONTAINER WITH SURFACE ORNAMENTATION**

Primary Examiner — Shannon W Morgan
Assistant Examiner — Keith Frank
(74) *Attorney, Agent, or Firm* — Amanda Herman Berghauer

(71) Applicant: **The Procter & Gamble Company**, Cincinnati, OH (US)

(72) Inventor: **Andreina Marcano**, Mason, OH (US)

(73) Assignee: **The Procter & Gamble Company**, Cincinnati, OH (US)

(**) Term: **15 Years**

(21) Appl. No.: **29/632,978**

(22) Filed: **Jan. 11, 2018**

(51) **LOC (12) Cl.** **09-01**

(52) **U.S. Cl.**
USPC **D9/516; D9/434**

(58) **Field of Classification Search**
USPC D9/434, 435, 516, 559, 575, 715, 719;
D3/203.1, 203.2; D20/22, 23, 27
CPC B65D 1/0223; B65D 51/24; B65D 51/245;
B65D 2543/00092
See application file for complete search history.

(56) **References Cited**

U.S. PATENT DOCUMENTS

D615,418 S *	5/2010	Criss	D9/711
D618,556 S *	6/2010	Partin	D9/643
D622,609 S *	8/2010	Partin	D9/645
D622,611 S *	8/2010	Powers	D9/434
D625,196 S *	10/2010	Partin	D9/645
D638,703 S *	5/2011	Sovonick	D9/434
D646,970 S *	10/2011	Sovonick	D9/434

(Continued)

OTHER PUBLICATIONS

U.S. Appl. No. 29/632,977, filed Jan. 11, 2018, Marcano et al.
(Continued)

(57) **CLAIM**

The ornamental design for an over the counter medicinal container with surface ornamentation, as shown and described.

DESCRIPTION

The present application file contains at least one drawing executed in color. Copies of this patent or patent application publication with color drawing(s) will be provided by the Office upon request and payment of the necessary fee.

FIG. 1 is a perspective view of an over the counter medicinal container with surface ornamentation embodying our new design;

FIG. 2 is a front view thereof;

FIG. 3 is a left side view thereof;

FIG. 4 is a rear view thereof;

FIG. 5 is a right side view thereof;

FIG. 6 is a top view thereof;

FIG. 7 is a bottom view thereof;

FIG. 8 is a perspective view of a second embodiment of an over the counter medicinal container with surface ornamentation embodying our new design;

FIG. 9 is a front view thereof;

FIG. 10 is a left side view thereof;

FIG. 11 is a rear view thereof;

FIG. 12 is a right side view thereof;

FIG. 13 is a top view thereof; and,

FIG. 14 is a bottom view thereof.

The evenly broken lines are shown for the purpose of illustrating parts of the article that form no part of the claim. The dot-dash lines represent the boundaries of the claim and form no part thereof.

1 Claim, 6 Drawing Sheets
(3 of 6 Drawing Sheet(s) Filed in Color)

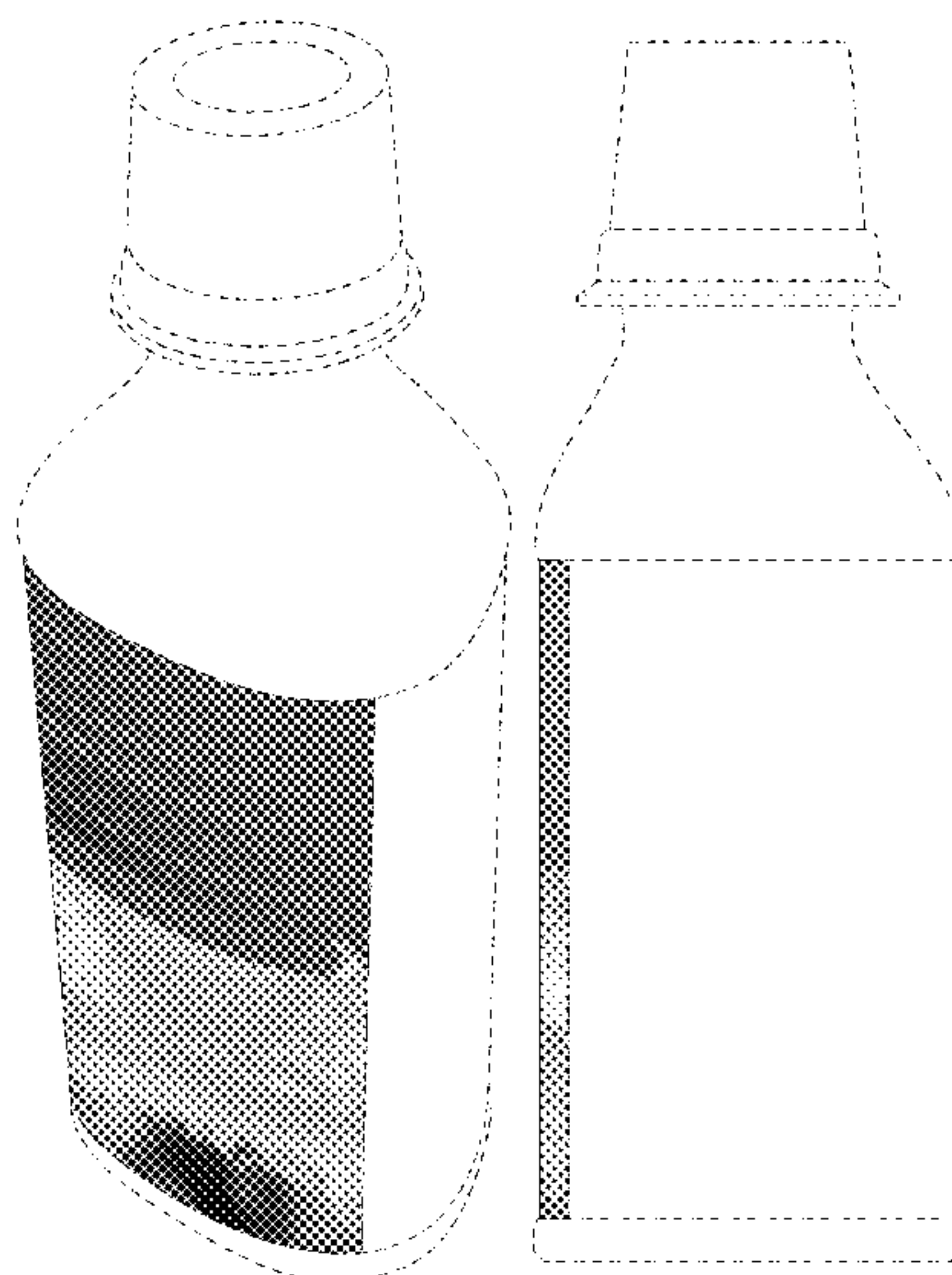

(56)

References Cited

U.S. PATENT DOCUMENTS

D648,214	S	*	11/2011	Gonzalez	D9/434
D648,218	S	*	11/2011	Powers	D9/516
D707,122	S	*	6/2014	Merchant	D9/434
D747,203	S	*	1/2016	Merchant	D9/516
D767,399	S	*	9/2016	Forsberg	D20/22
D786,680	S	*	5/2017	Merchant	D9/516
D813,030	S	*	3/2018	Powers	D9/516
D824,251	S	*	7/2018	Torres	D9/430
D826,710	S	*	8/2018	Torres	D9/430
D827,428	S	*	9/2018	Torres	D9/430

OTHER PUBLICATIONS

- U.S. Appl. No. 29/632,976, filed Jan. 11, 2018, Marcano et al.
- U.S. Appl. No. 29/632,974, filed Jan. 11, 2018, Murchison et al.
- U.S. Appl. No. 29/632,973, filed Jan. 11, 2018, Murchison et al.

* cited by examiner

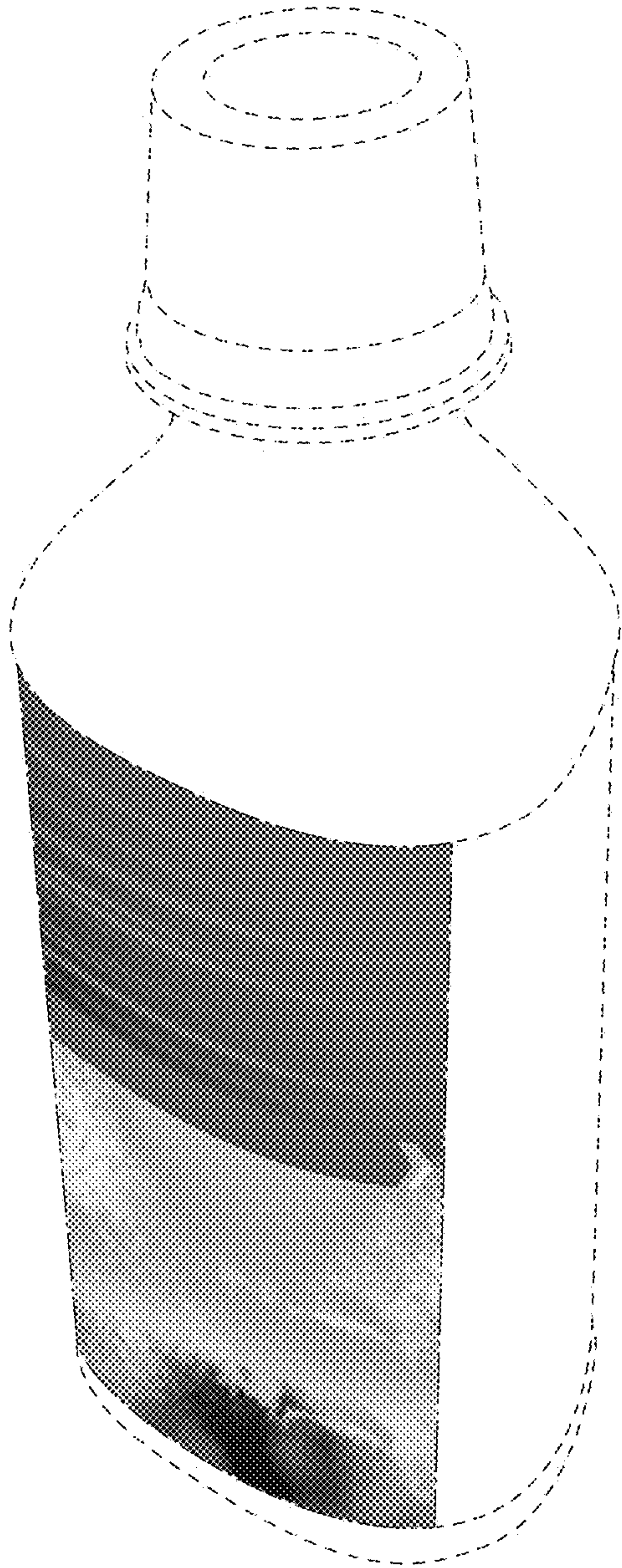

FIG. 1

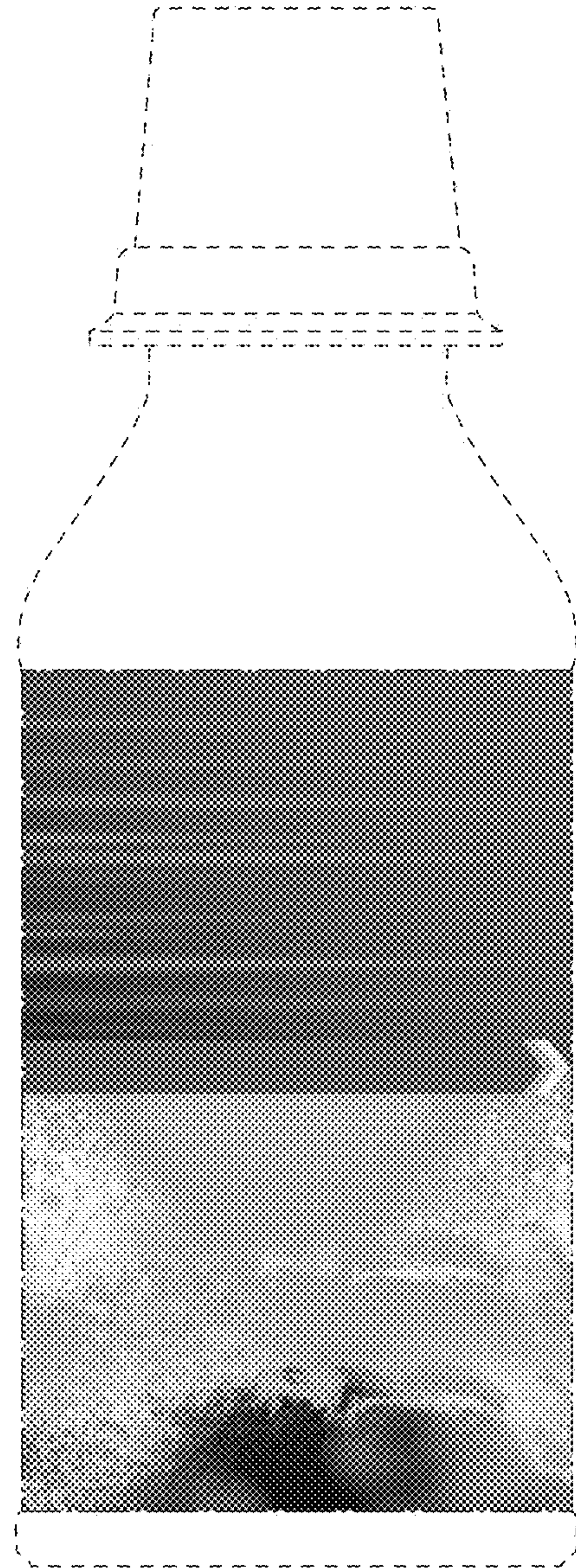

FIG. 2

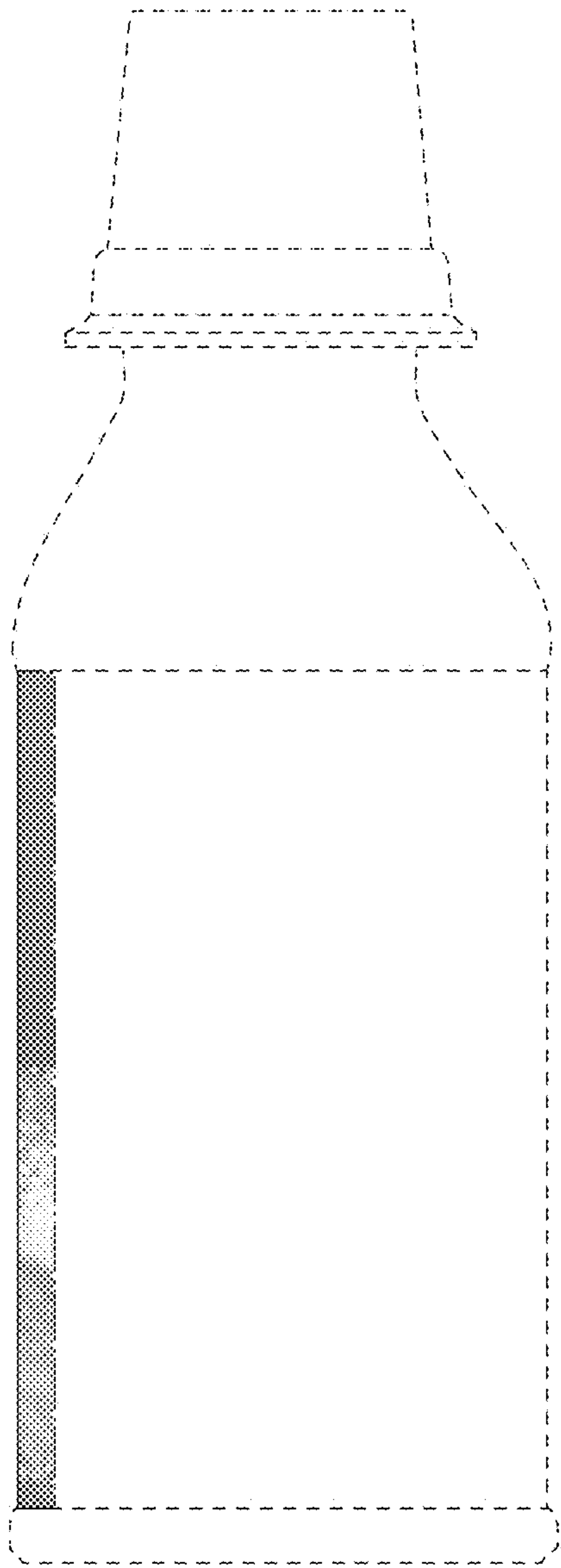

FIG. 3

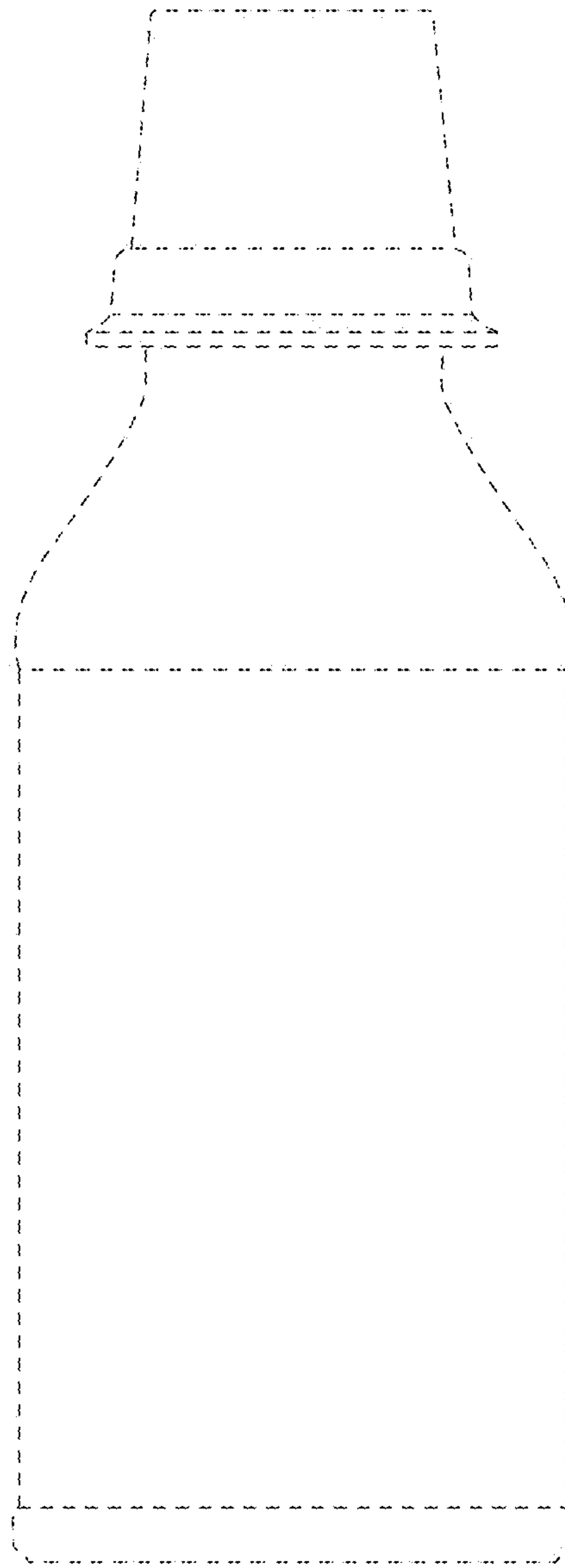

FIG. 4

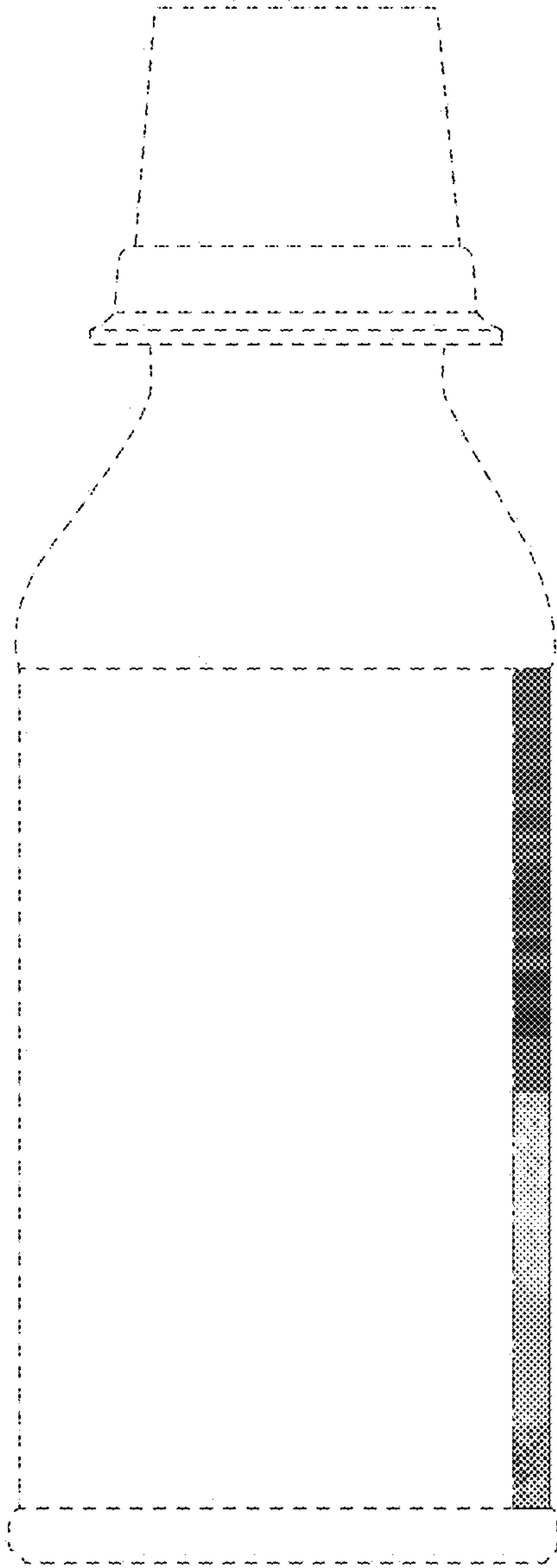

FIG. 5

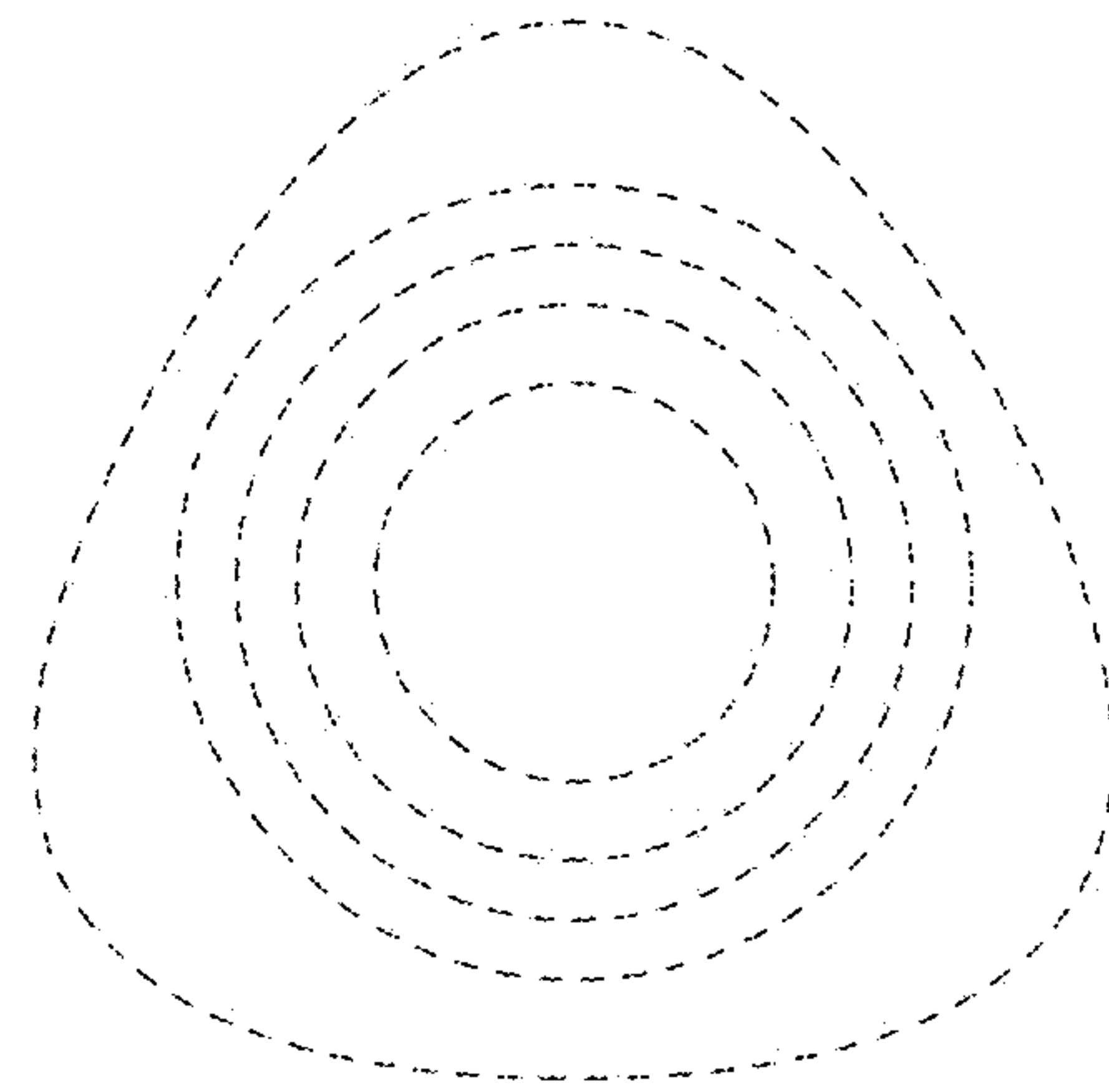

FIG. 6

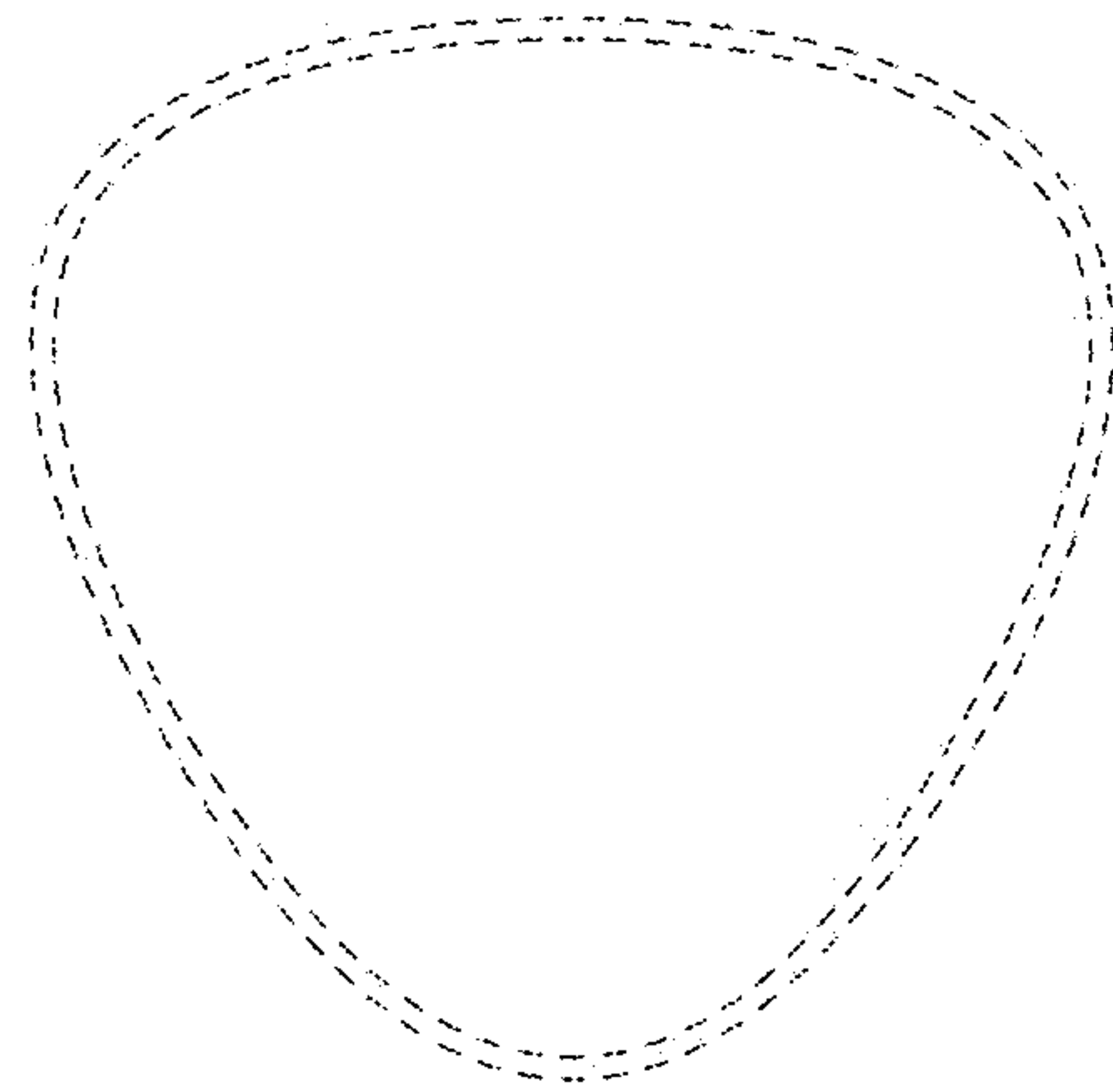

FIG. 7

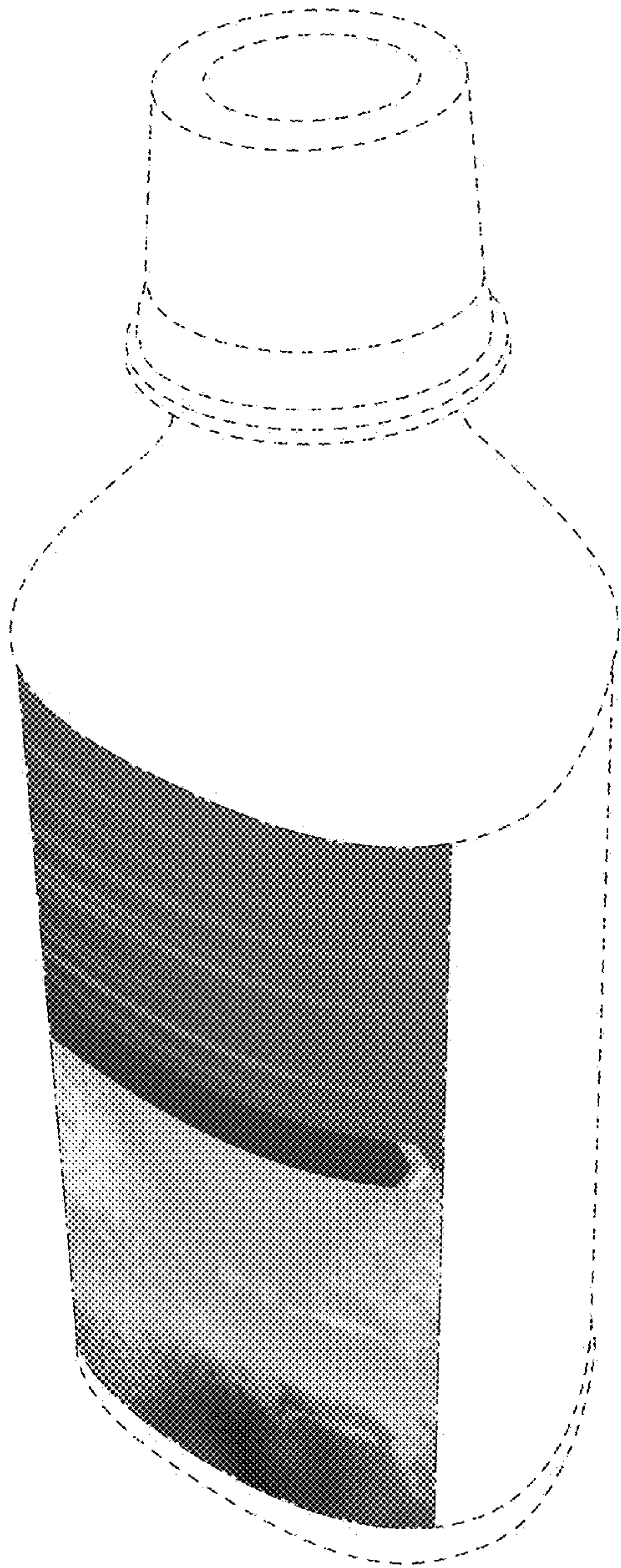

FIG. 8

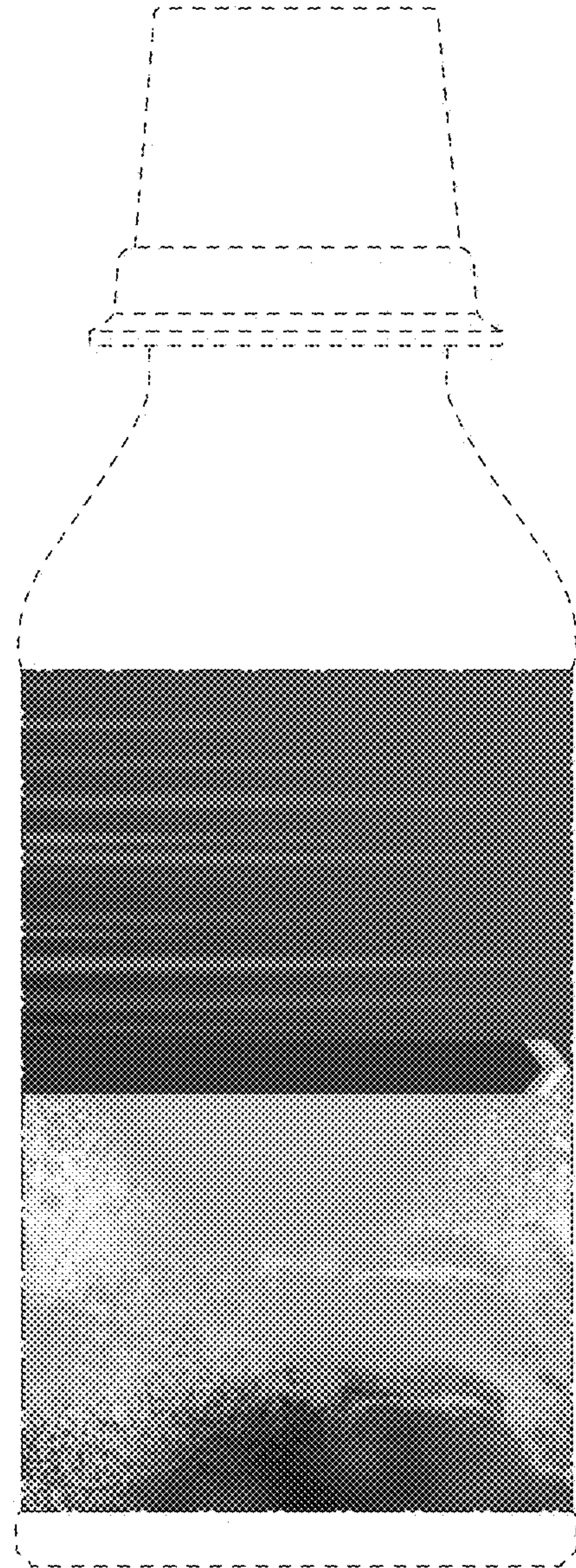

FIG. 9

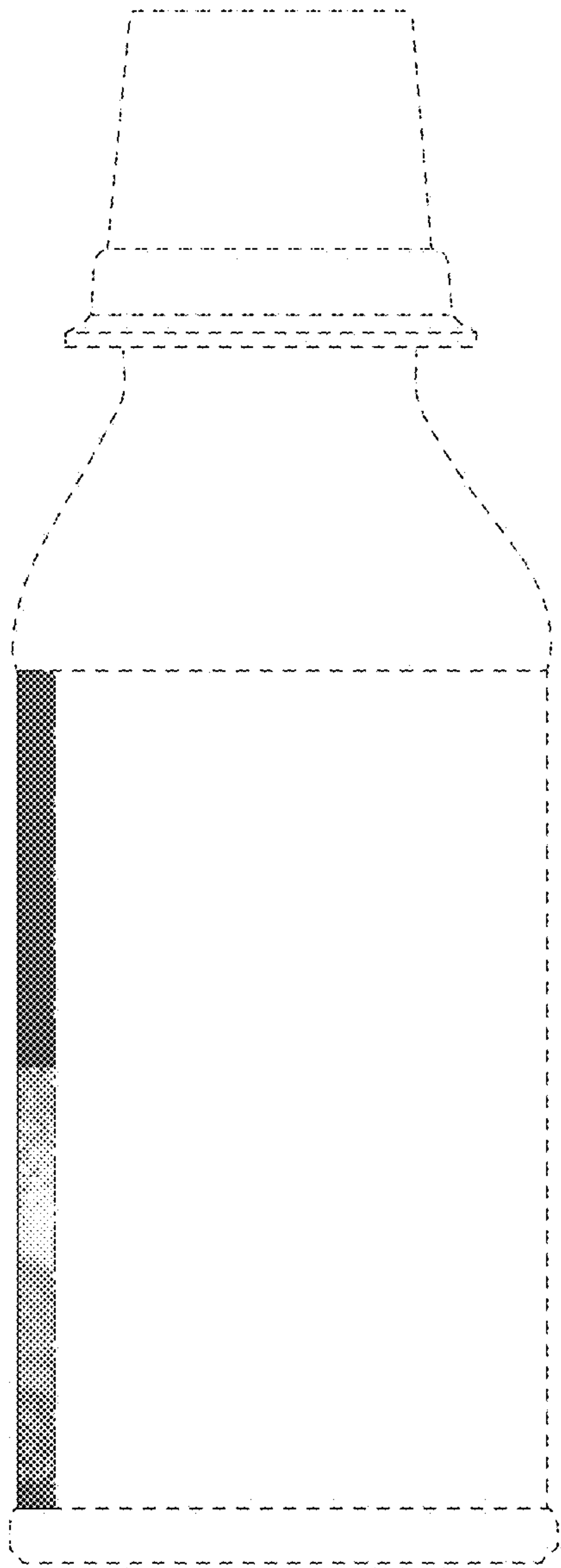

FIG. 10

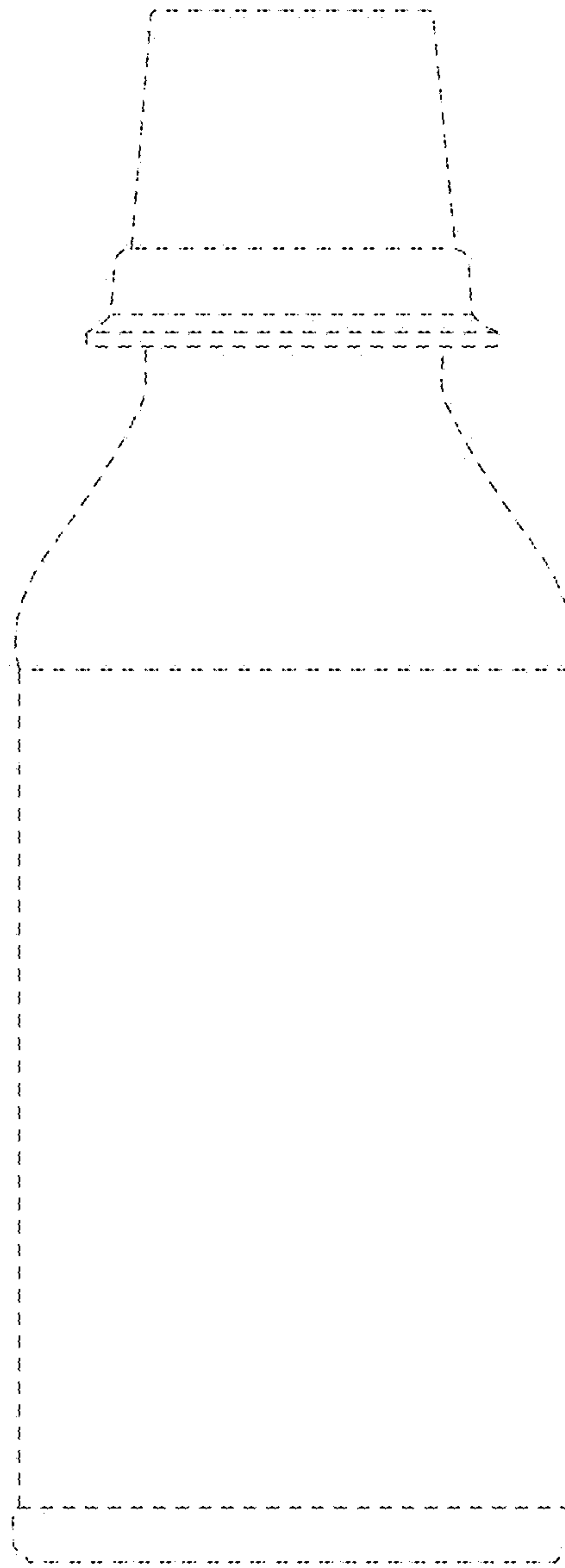

FIG. 11

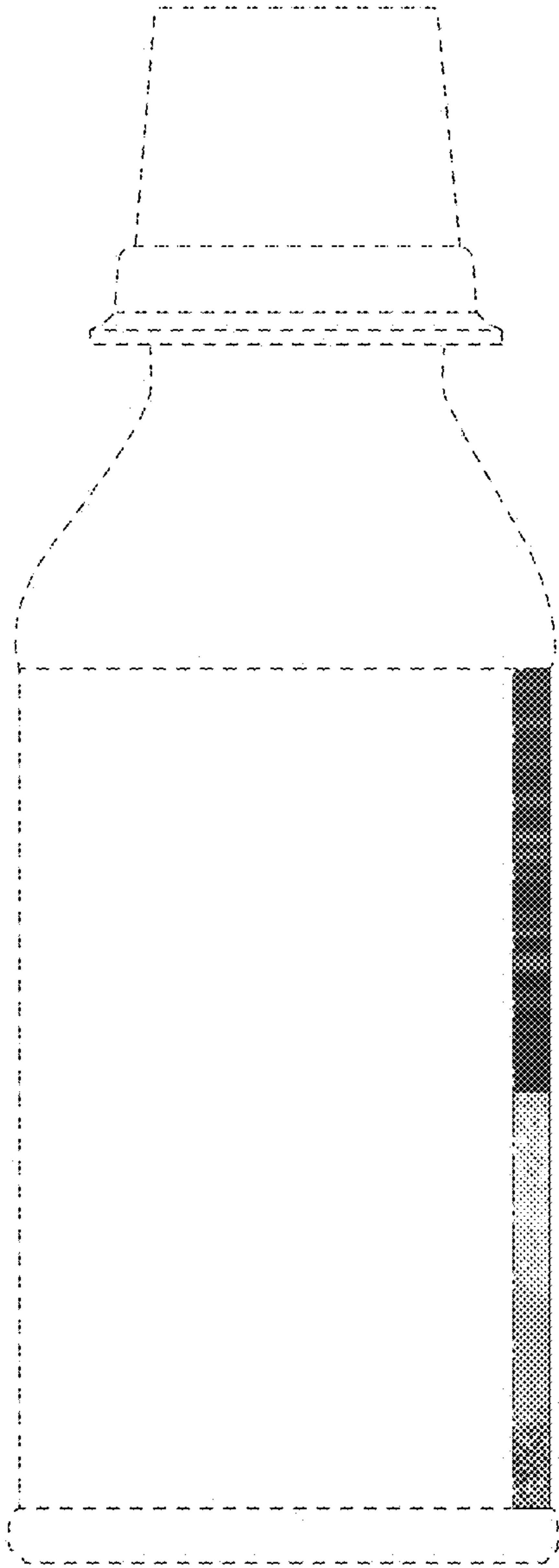

FIG. 12

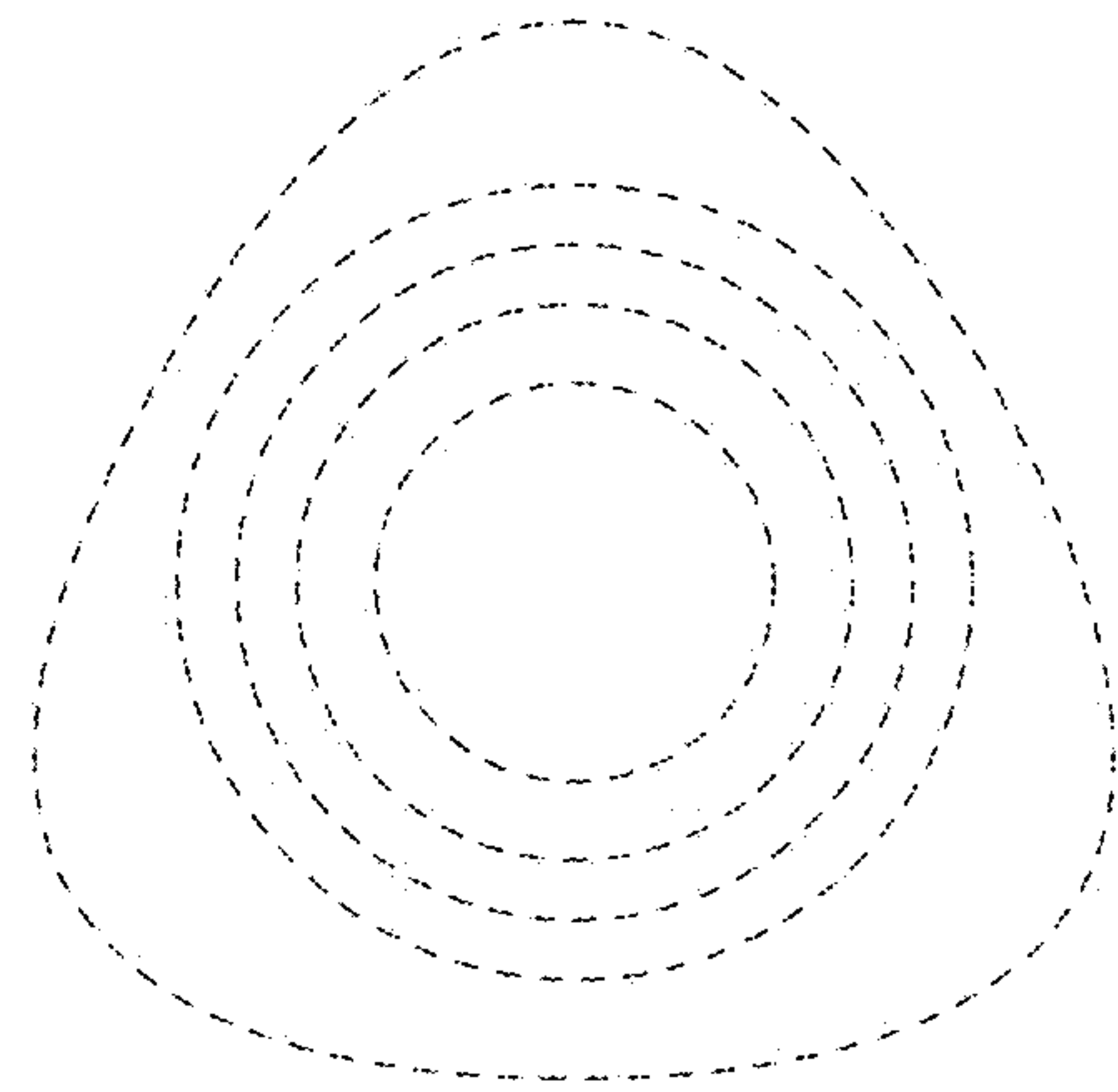

FIG. 13

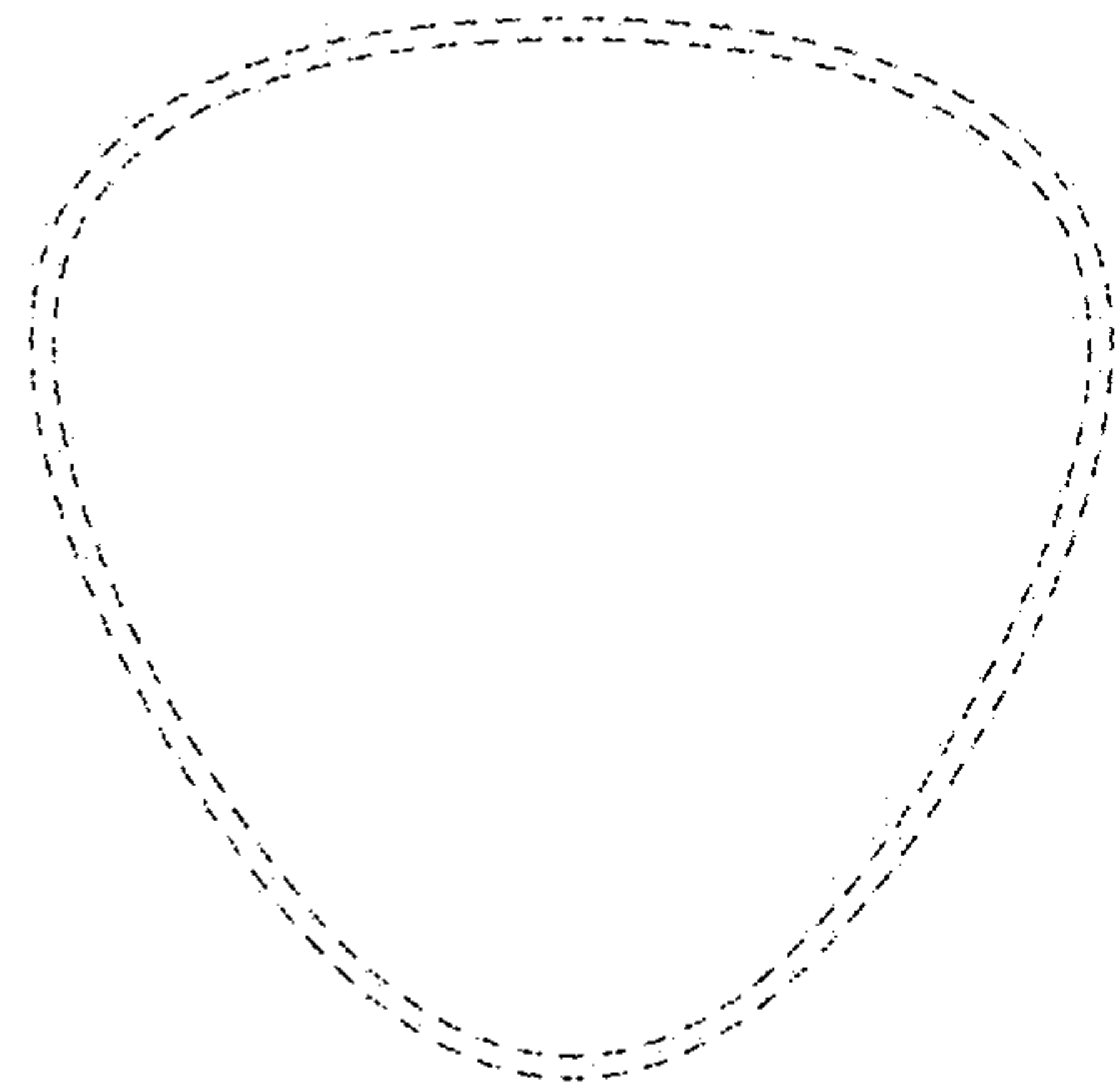

FIG. 14