



US00D883708S

(12) **United States Design Patent**
Dittrich

(10) **Patent No.:** **US D883,708 S**

(45) **Date of Patent:** **** May 12, 2020**

(54) **SOAP HOLDER**

D532,639 S * 11/2006 Snell D6/567
D629,255 S * 12/2010 Sellers D7/590
D681,989 S * 5/2013 Pixley D6/536

(71) Applicant: **Spectrum Diversified Designs, LLC**,
Streetsboro, OH (US)

(72) Inventor: **Megan Leigh Dittrich**, Twinsburg, OH
(US)

(73) Assignee: **Spectrum Diversified Designs, LLC**,
Streetsboro, OH (US)

(**) Term: **15 Years**

(21) Appl. No.: **29/679,667**

(22) Filed: **Feb. 8, 2019**

(51) **LOC (12) Cl.** **23-02**

(52) **U.S. Cl.**
USPC **D6/540**

(58) **Field of Classification Search**
USPC D6/540, 532, 536, 538, 539; D7/502,
D7/550, 554.2; D9/682, 690, 692;
206/77.1, 557, 587, 823; 211/13.1, 85.4,
211/87, 85.12
CPC .. A47K 5/04; A47K 5/02; A45D 27/16; E03C
1/24
See application file for complete search history.

(56) **References Cited**

U.S. PATENT DOCUMENTS

D402,839 S * 12/1998 Bova D6/540
D407,252 S * 3/1999 Hampshire D6/540

OTHER PUBLICATIONS

Cora Suction Sink Sponge Holder, [online], [retrieved on Feb. 8, 2019]. Retrieved from Internet, <URL: <https://www.spectrumdiversified.com/products/Cora-Suction-Sink-Sponge-Holder>>.

* cited by examiner

Primary Examiner — Wan Laymon
Assistant Examiner — Mark Booker

(74) *Attorney, Agent, or Firm* — Renner, Otto, Boisselle and Sklar, LLP

(57) **CLAIM**

The ornamental design for a soap holder, as shown and described.

DESCRIPTION

FIG. 1 is a top, right, front perspective view of a soap holder showing my new design;
FIG. 2 is a front elevation view thereof;
FIG. 3 is a rear elevation view thereof;
FIG. 4 is right side elevation view thereof;
FIG. 5 is a left side elevation view thereof;
FIG. 6 is a top plan view thereof; and,
FIG. 7 is a bottom plan view thereof.
The broken line showing is for the purpose of illustrating unclaimed portions of the article and forms no part of the claimed design.

1 Claim, 4 Drawing Sheets

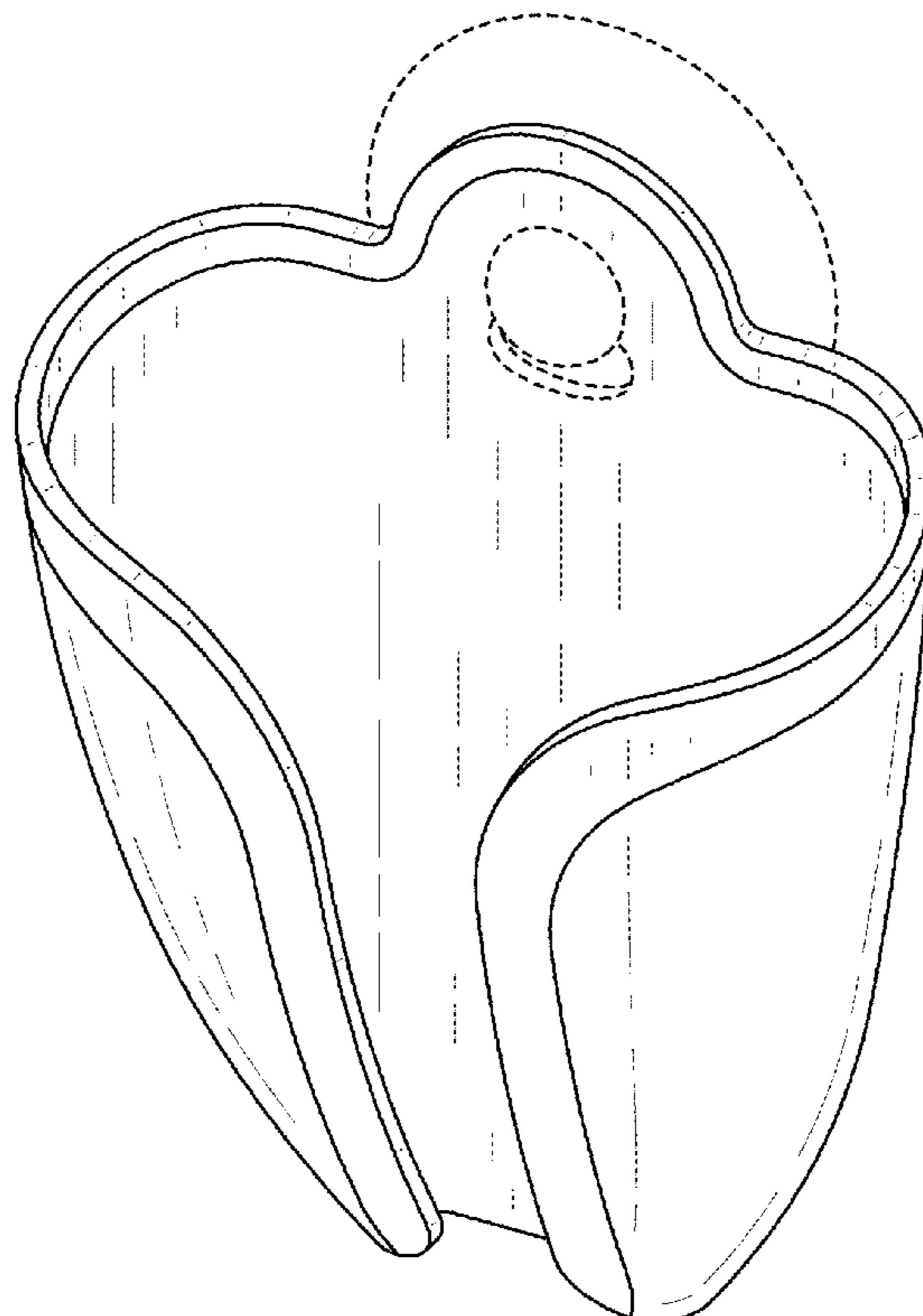

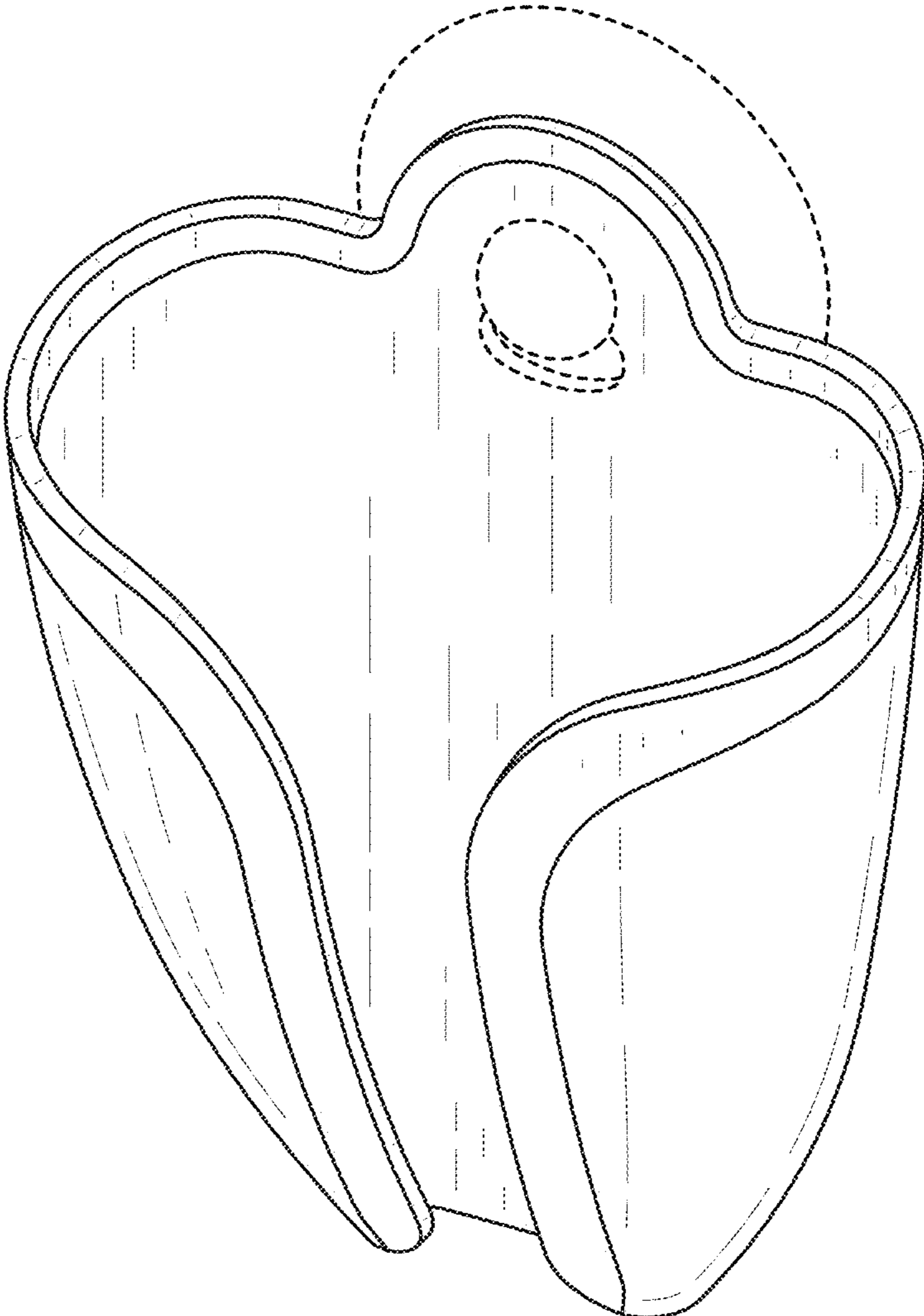

FIG. 1

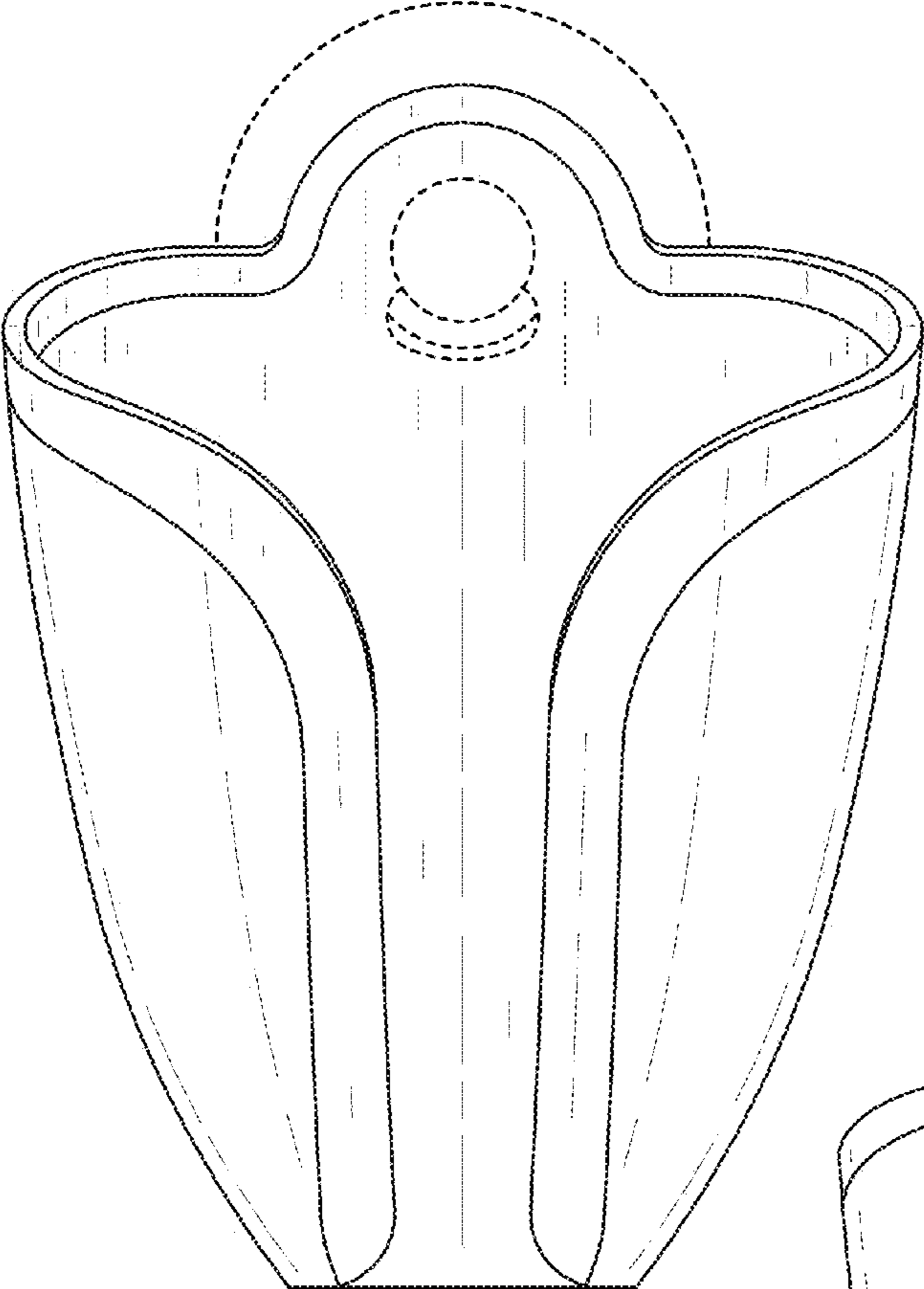

FIG. 2

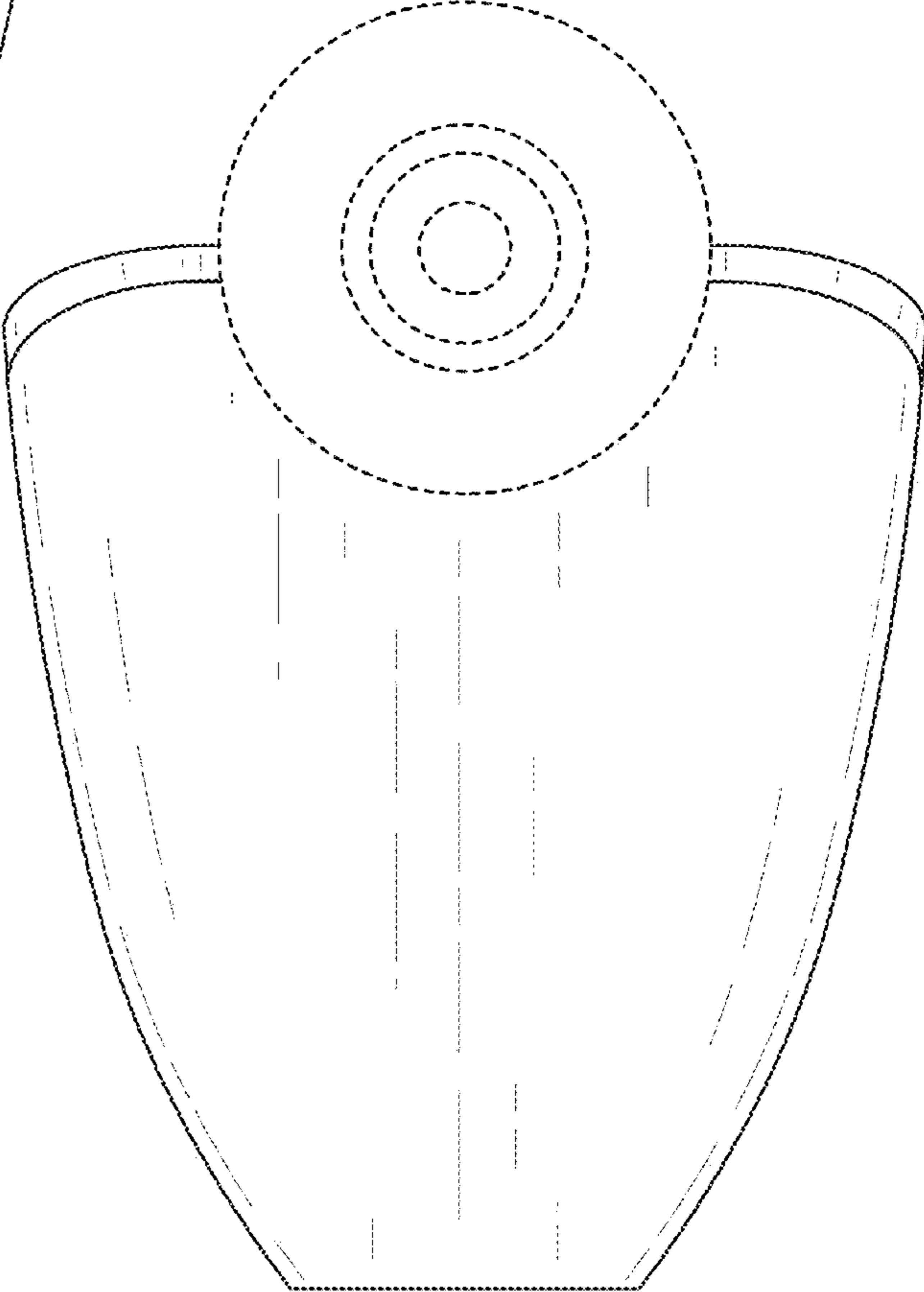

FIG. 3

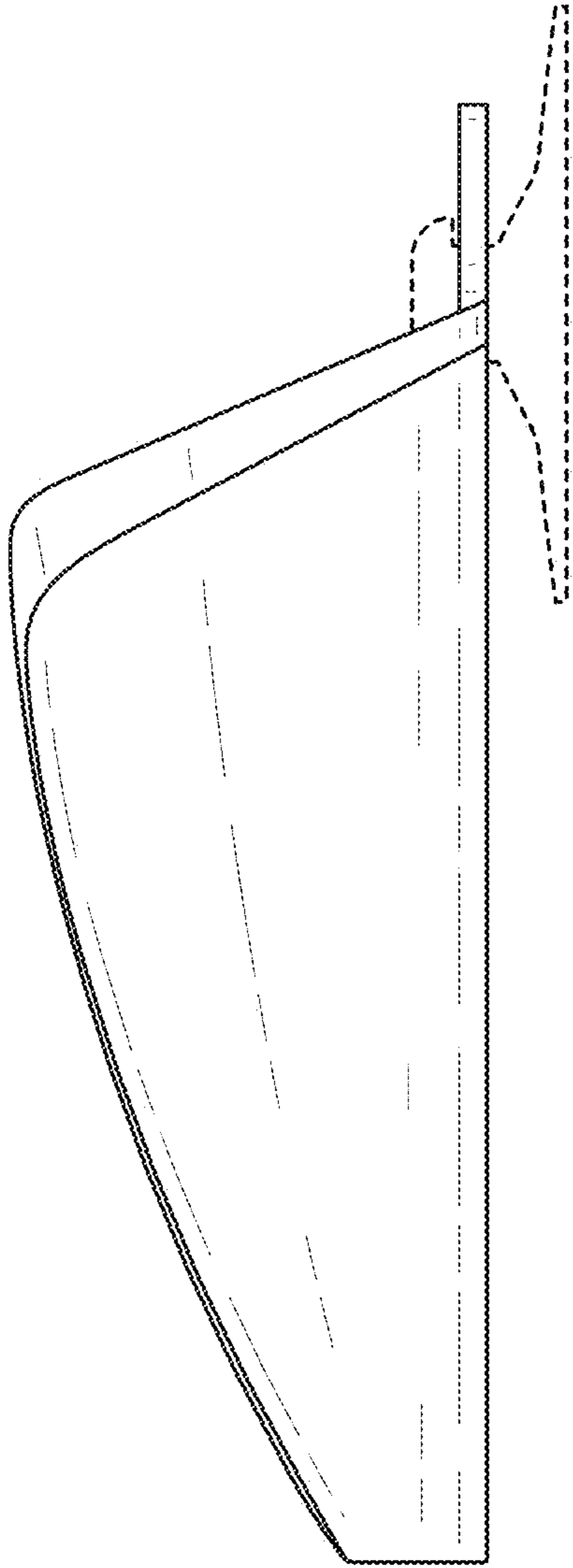

FIG. 4

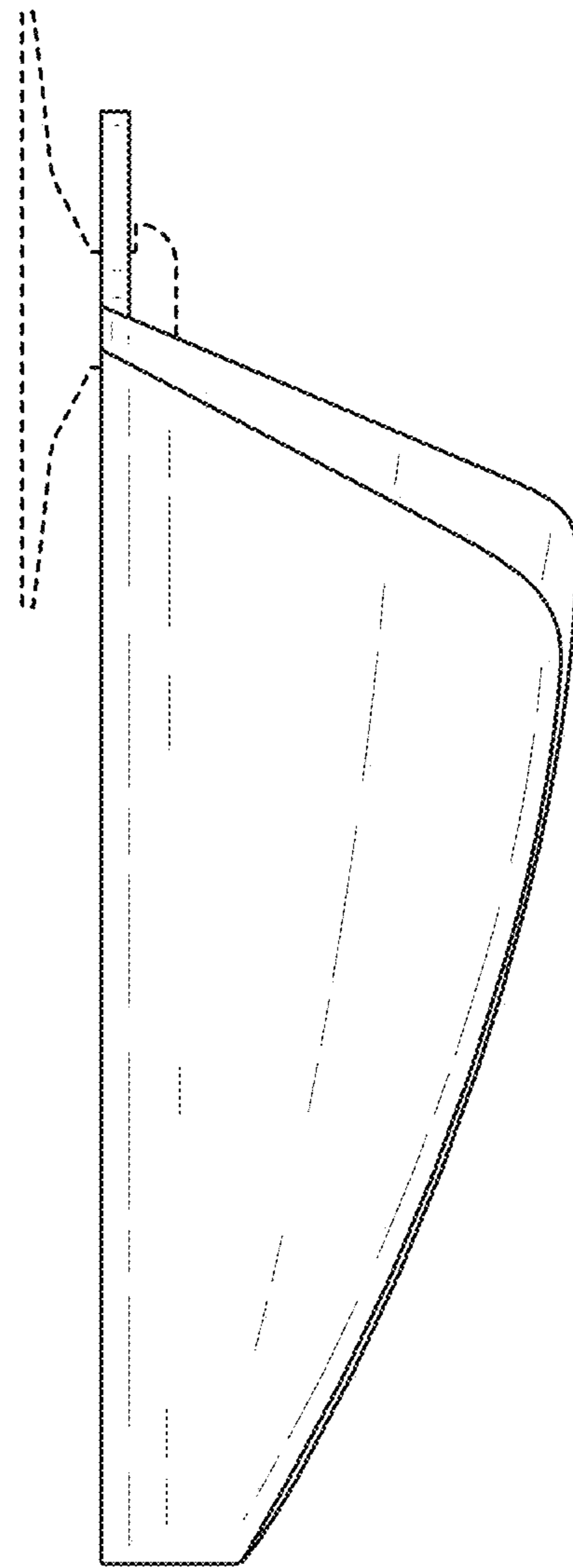

FIG. 5

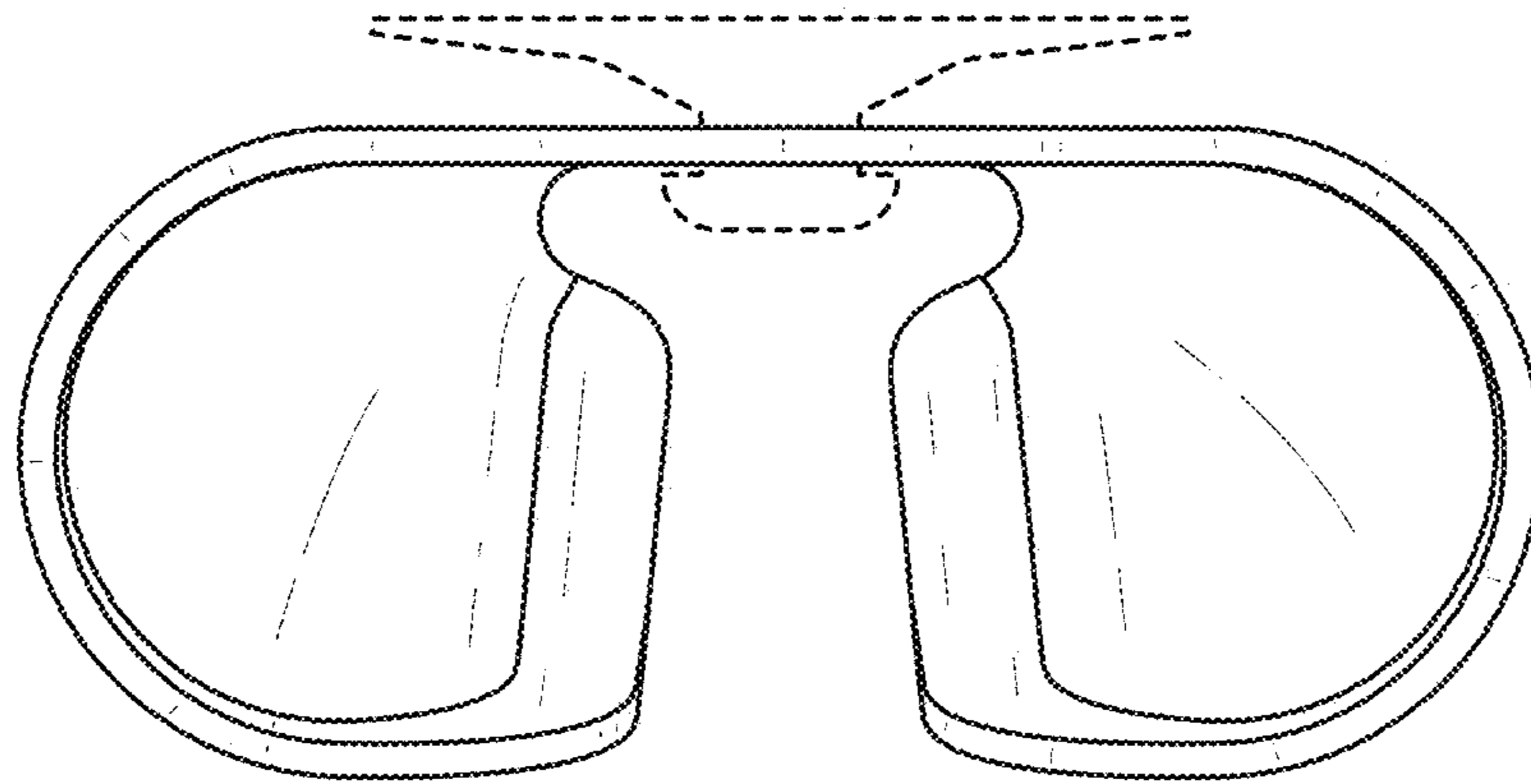

FIG. 6

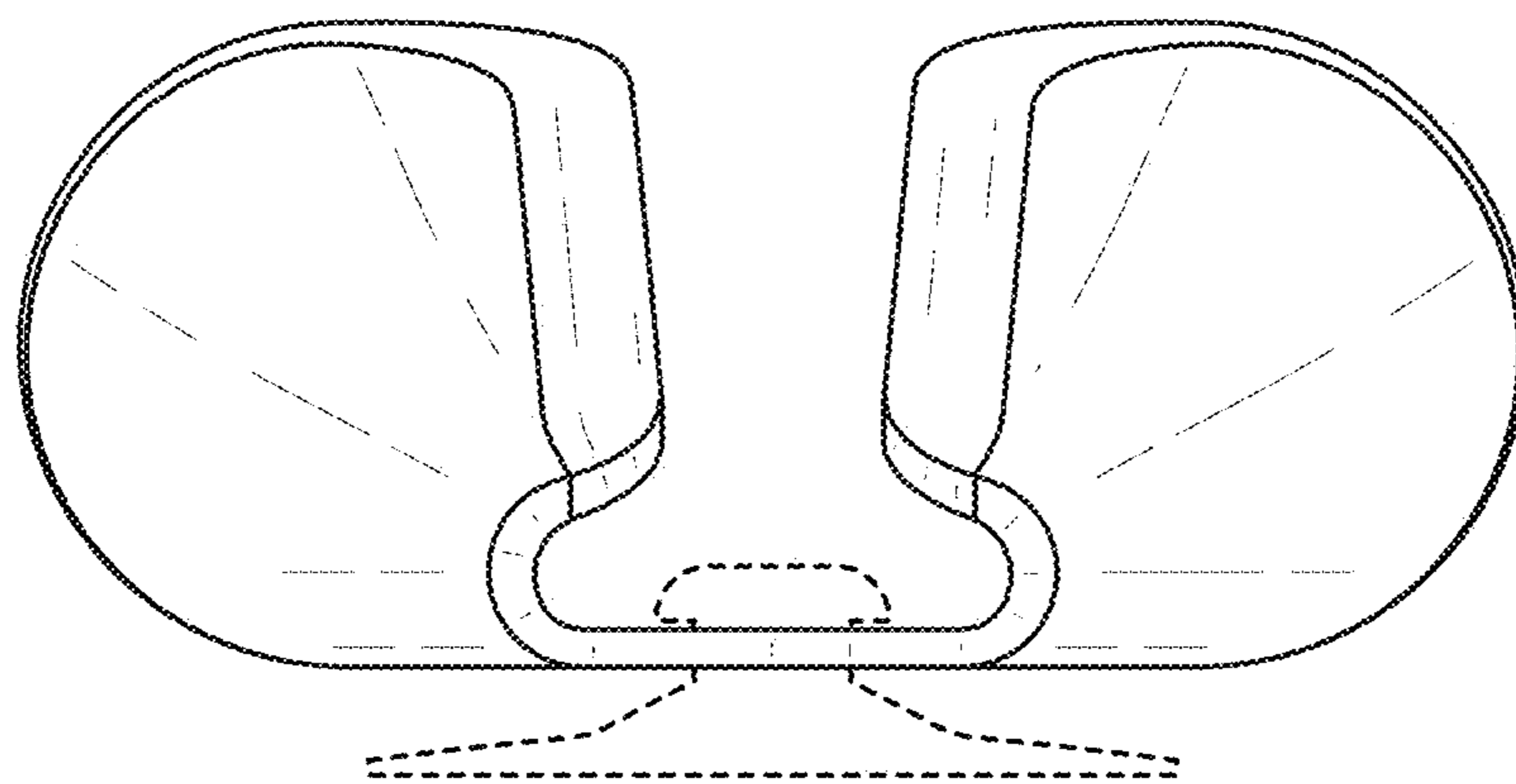

FIG. 7