



US00D883660S

(12) **United States Design Patent**  
**He**

(10) **Patent No.:** **US D883,660 S**

(45) **Date of Patent:** **\*\* May 12, 2020**

(54) **BACKPACK**

(71) Applicant: **Guangcheng He**, Henan Province (CN)

(72) Inventor: **Guangcheng He**, Henan Province (CN)

(\*\*) Term: **15 Years**

(21) Appl. No.: **29/718,539**

(22) Filed: **Dec. 26, 2019**

(51) **LOC (12) Cl.** ..... **03-01**

(52) **U.S. Cl.**  
USPC ..... **D3/217**

(58) **Field of Classification Search**  
USPC ..... D3/216, 217  
CPC ..... A45F 3/04; A45F 4/02  
See application file for complete search history.

(56) **References Cited**

**U.S. PATENT DOCUMENTS**

- 4,085,873 A \* 4/1978 Schweitzer ..... A45C 7/0077  
224/153
- D277,901 S \* 3/1985 Leslie ..... D3/217
- D340,351 S \* 10/1993 Wrath ..... D3/217
- D375,403 S \* 11/1996 Melk ..... D3/217
- D471,013 S \* 3/2003 Peterson ..... D3/254
- D830,686 S \* 10/2018 Rogers ..... D3/217
- D833,736 S \* 11/2018 Voll ..... D3/217

- D857,376 S 8/2019 Thibadeau
- D877,494 S \* 3/2020 Roure ..... D3/217
- 2002/0096409 A1\* 7/2002 Roegner ..... A45C 3/00  
190/109

\* cited by examiner

*Primary Examiner* — Jennifer L Watkins

(74) *Attorney, Agent, or Firm* — ZANIP

(57) **CLAIM**

The ornamental design for a backpack, as shown and described.

**DESCRIPTION**

FIG. 1 is a front and top perspective view of a backpack, showing my new design;  
 FIG. 2 is a rear and bottom perspective view thereof;  
 FIG. 3 is a front elevational view thereof;  
 FIG. 4 is a rear elevational view thereof;  
 FIG. 5 is a left side elevational view thereof;  
 FIG. 6 is a right side elevational view thereof;  
 FIG. 7 is a top plan view thereof; and,  
 FIG. 8 is a bottom plan view thereof.

**1 Claim, 8 Drawing Sheets**



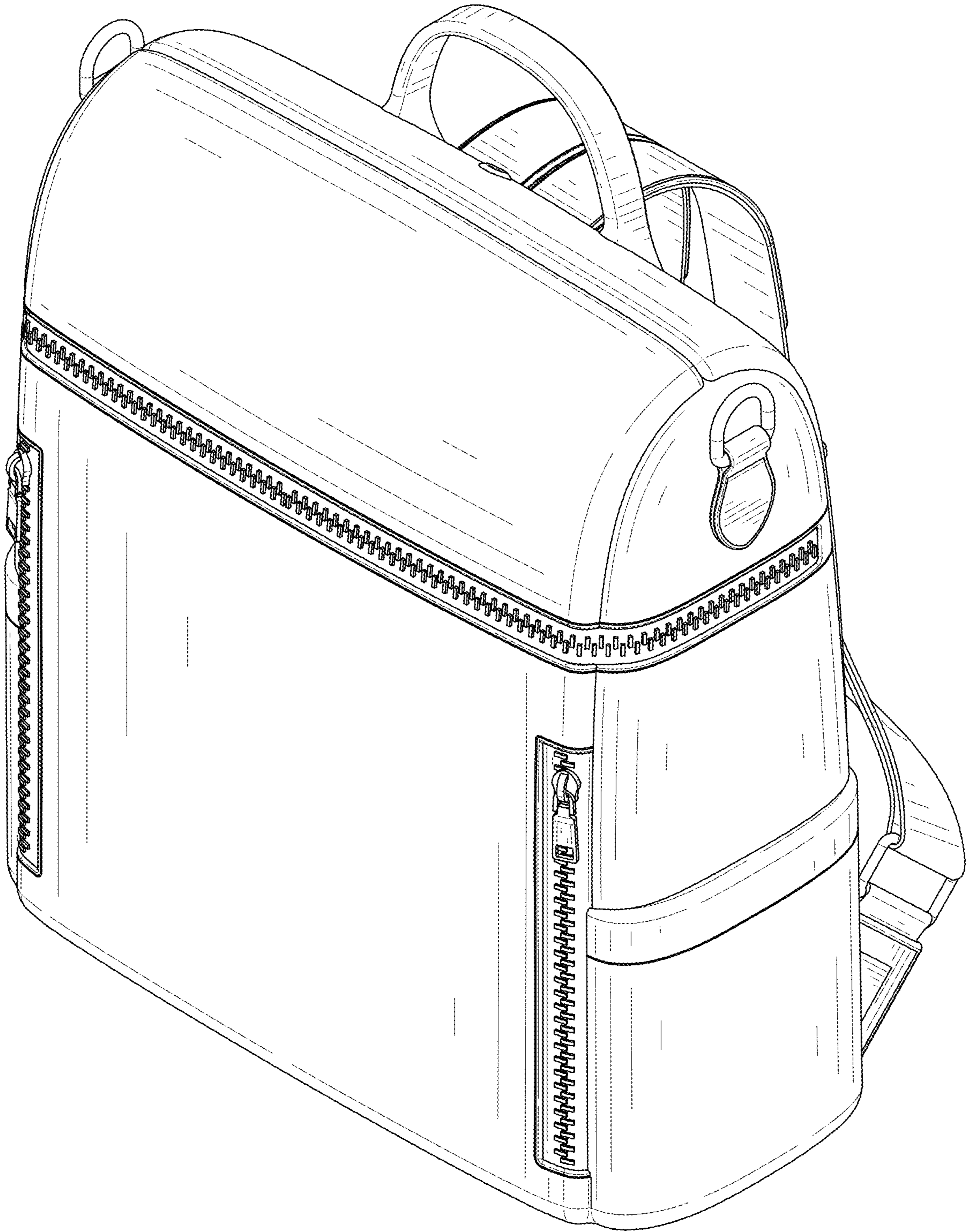

FIG. 1





FIG. 2

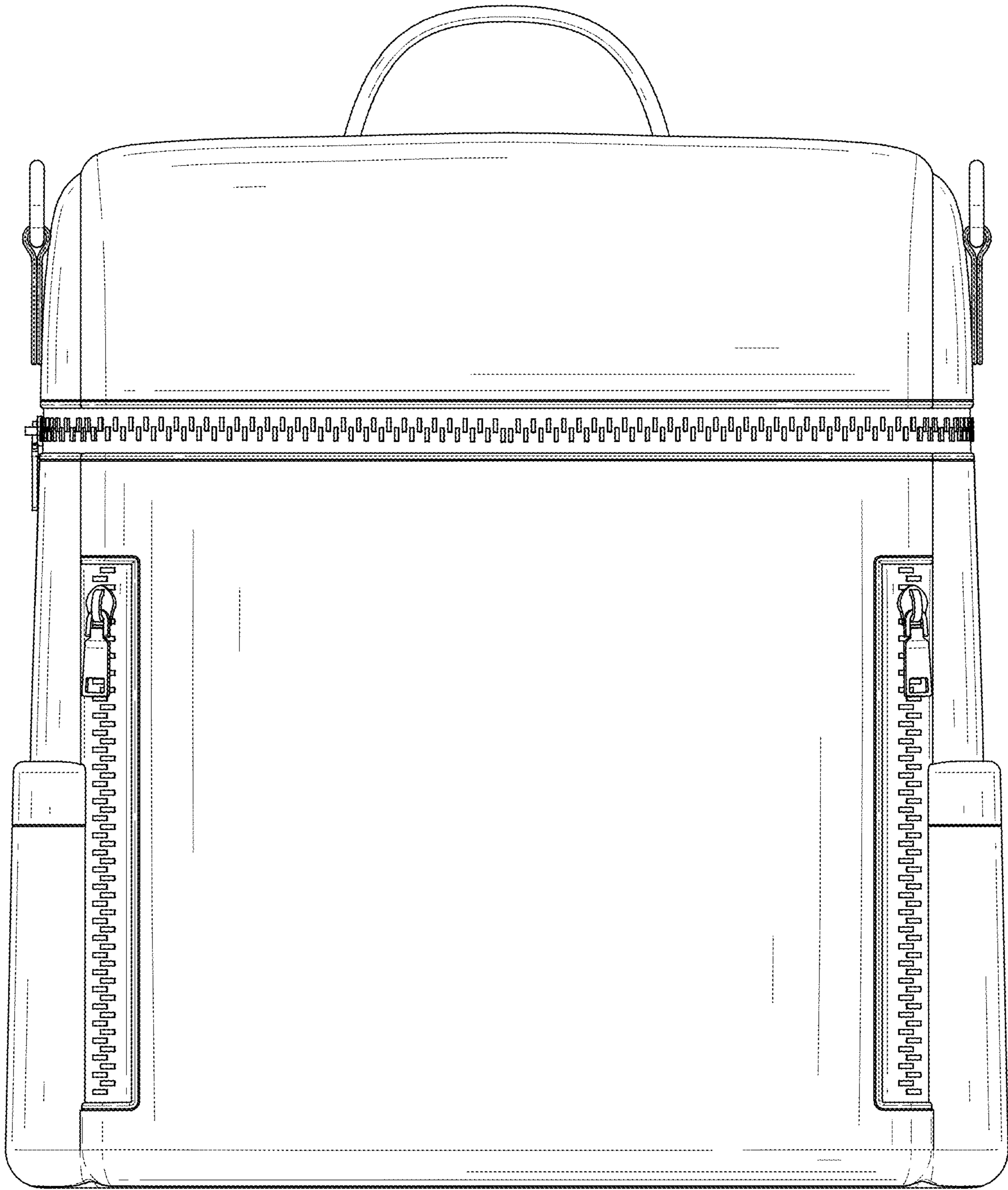

FIG. 3

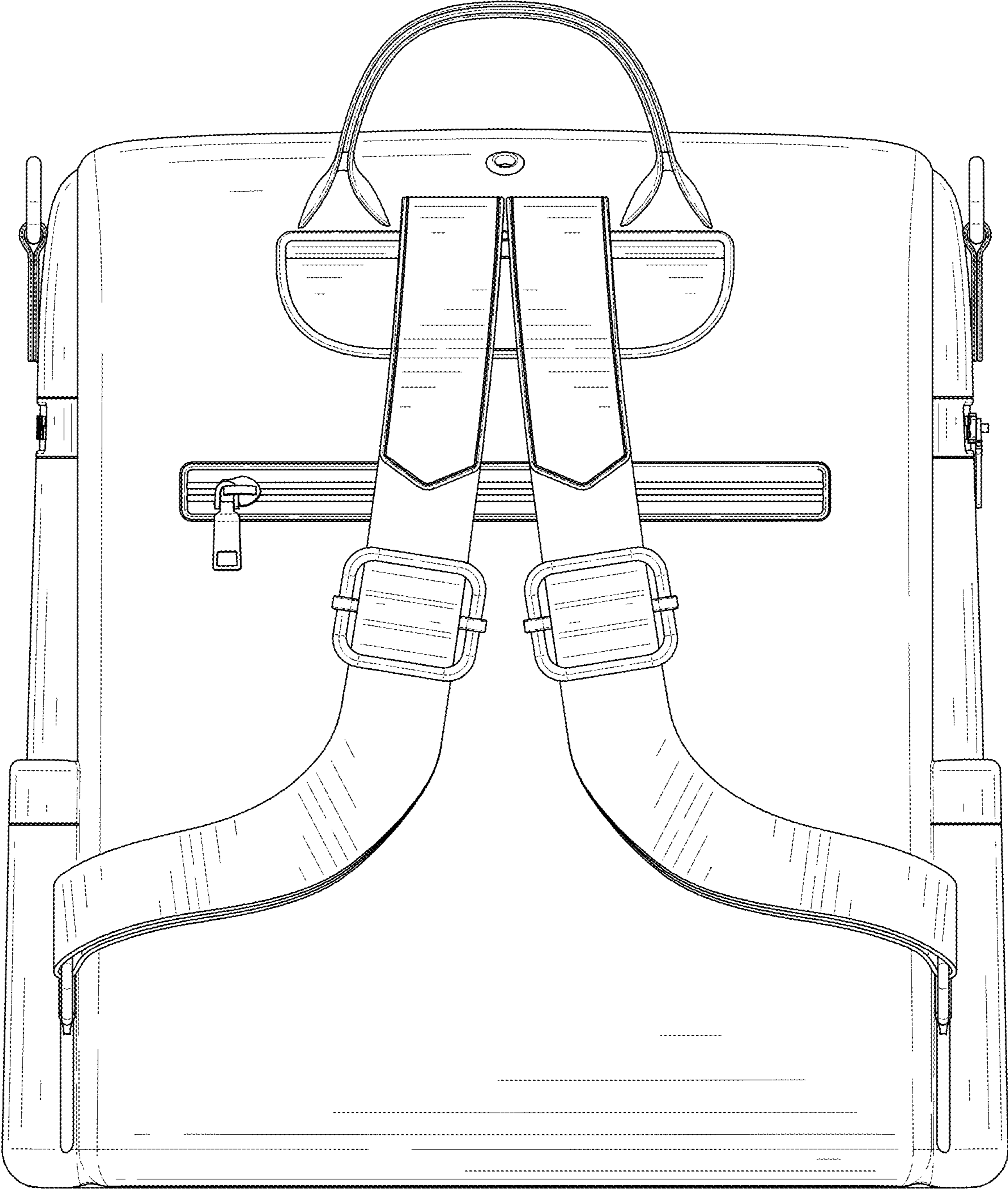

FIG. 4



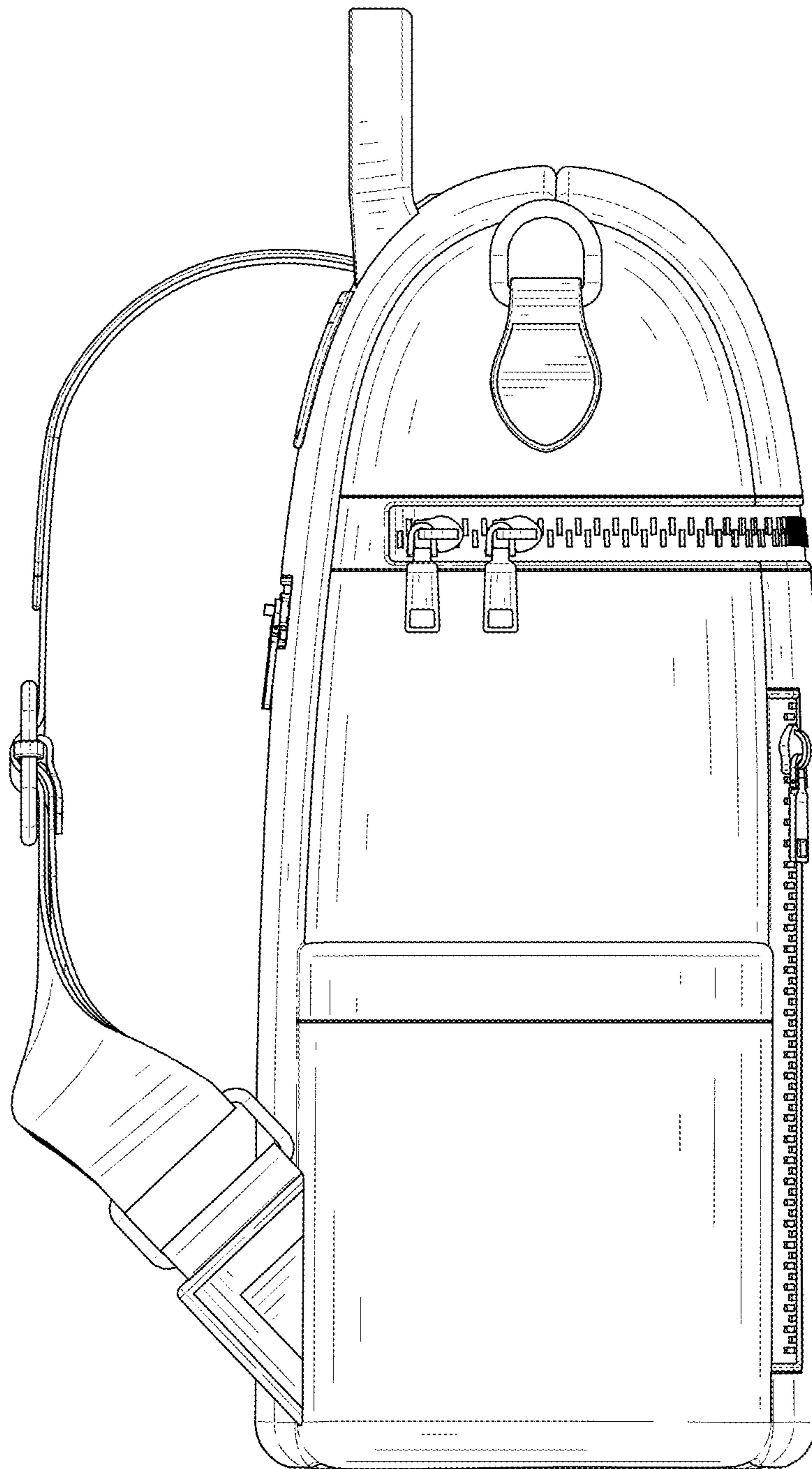

FIG. 5

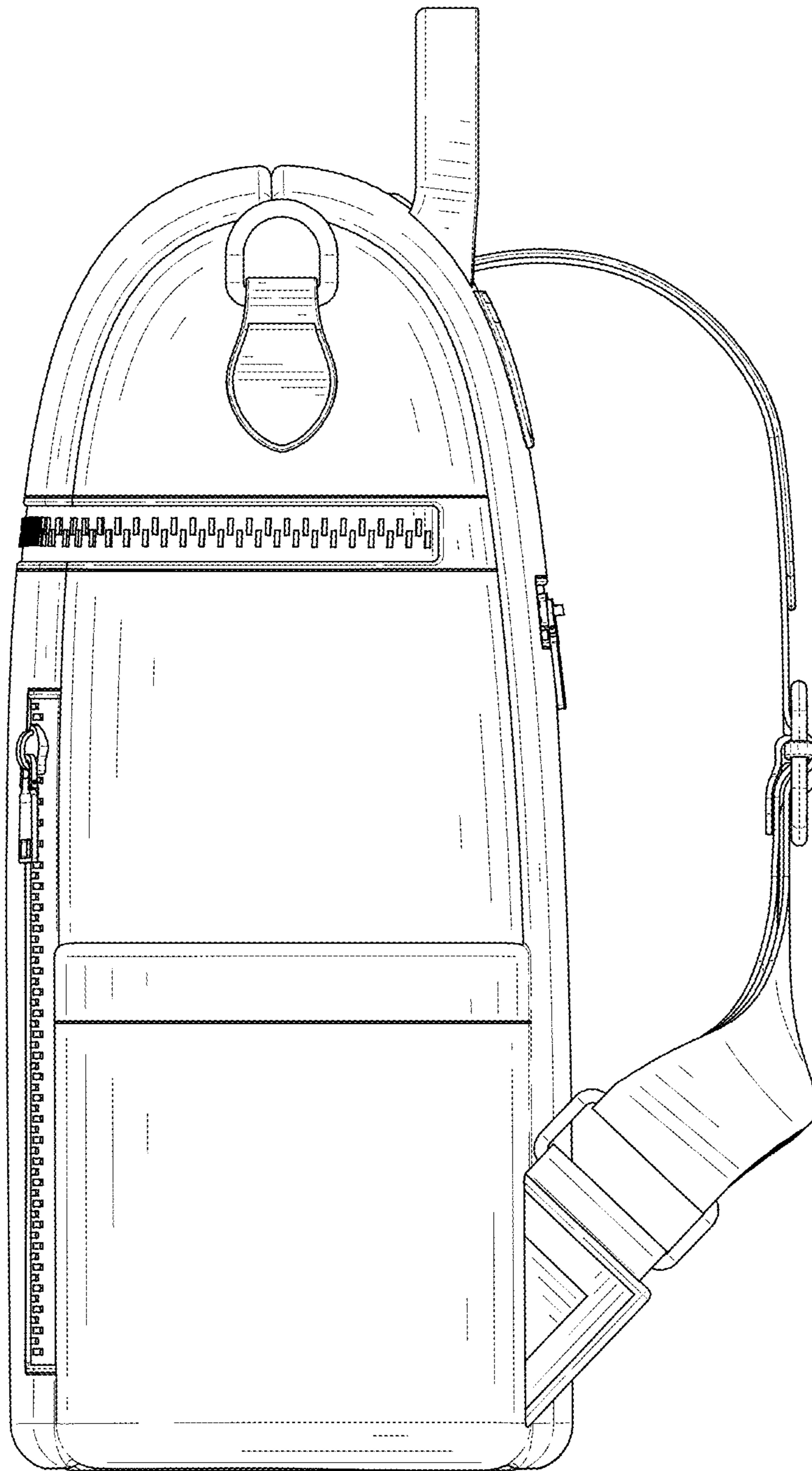

FIG. 6

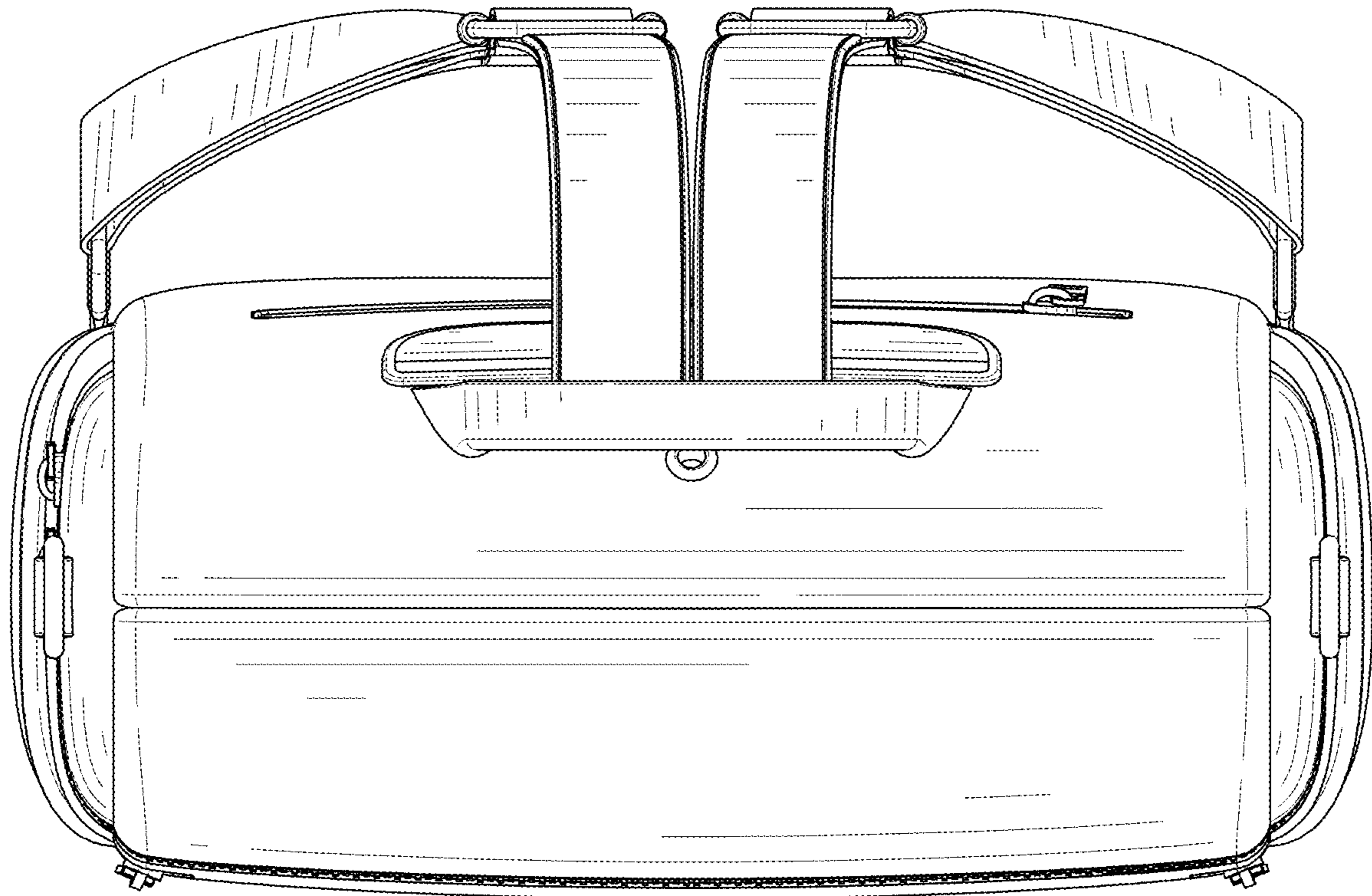

FIG. 7



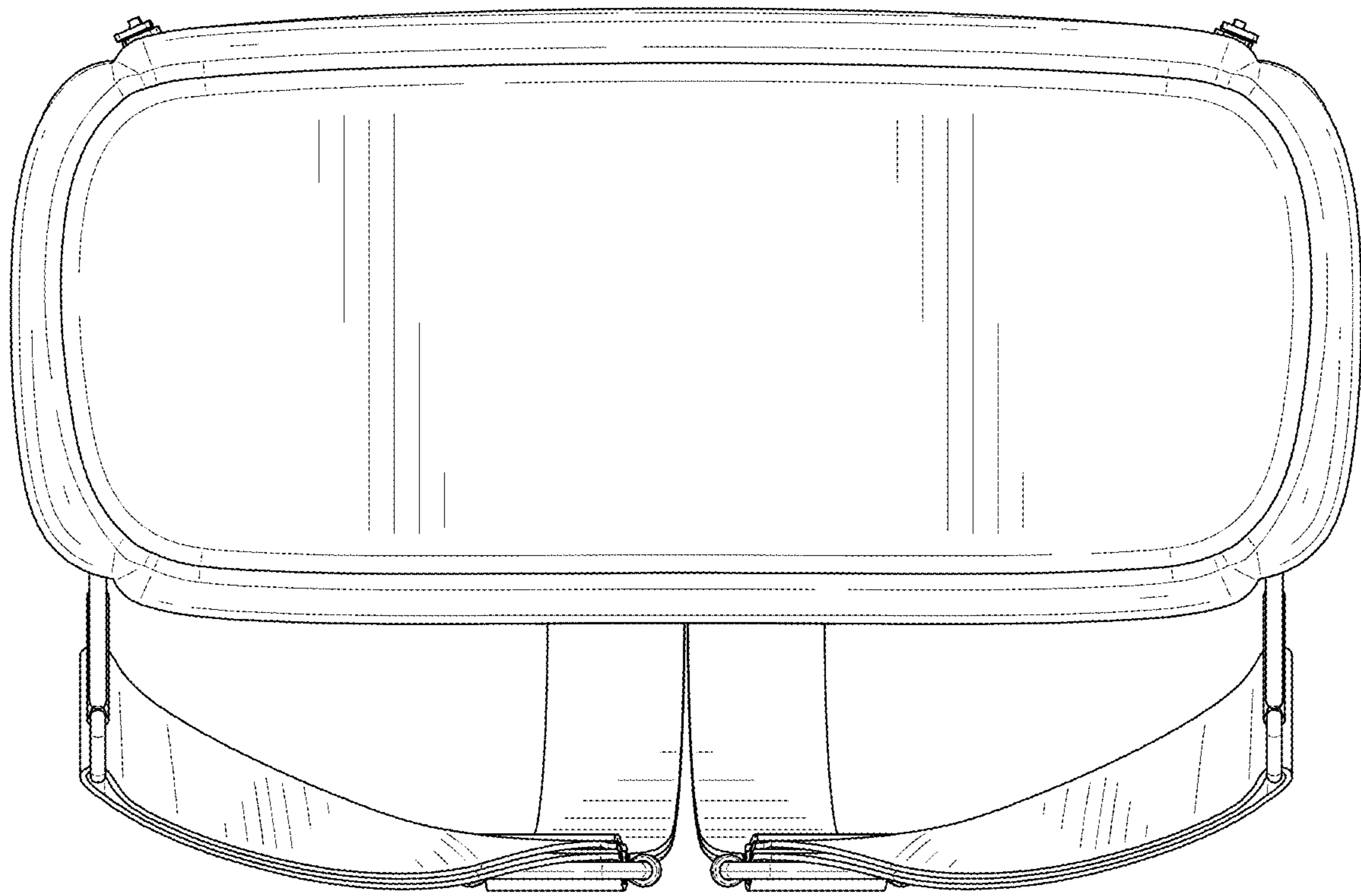

FIG. 8