



US00D883571S

(12) **United States Design Patent**
Psimadas et al.

(10) **Patent No.:** **US D883,571 S**

(45) **Date of Patent:** **** May 5, 2020**

(54) **SHAVER HANDLE**

(71) Applicant: **Societe BIC**, Clichy (FR)

(72) Inventors: **Ioannis Marios Psimadas**, Athens (GR); **Christoforos Athanasios Brellis**, Athens (GR); **Maria Petratou**, Athens (GR); **Triantafyllia Kottidi**, Athens (GR)

(73) Assignee: **Societe BIC**, Clichy (FR)

(**) Term: **15 Years**

(21) Appl. No.: **29/702,529**

(22) Filed: **Aug. 20, 2019**

Related U.S. Application Data

(62) Division of application No. 29/643,344, filed on Apr. 6, 2018.

(30) **Foreign Application Priority Data**

Oct. 10, 2017 (EM) 004393965-0001
Apr. 5, 2018 (EM) 005204690

(51) **LOC (12) Cl.** **28-03**

(52) **U.S. Cl.**
USPC **D28/48**

(58) **Field of Classification Search**
USPC D28/46-48
CPC B26B 21/00-06; B26B 21/08-227; B26B 21/24-28; B26B 21/30-38; B26B 21/40-4093; B26B 21/52-528
See application file for complete search history.

(56) **References Cited**

U.S. PATENT DOCUMENTS

D495,828 S * 9/2004 Ham D28/48
D659,287 S * 5/2012 Psimadas D28/48

D664,714 S * 7/2012 Christie D28/48
D749,784 S * 2/2016 Go D28/48
D750,324 S * 2/2016 Bae D28/48
D789,609 S * 6/2017 Kong D28/48
D792,025 S * 7/2017 Faktorovich D28/48
D808,590 S * 1/2018 Christofidellis D28/48
D812,815 S * 3/2018 Psimadas D28/48
D813,456 S * 3/2018 Christofidellis D28/48
D815,354 S * 4/2018 Psimadas D28/48
D818,645 S * 5/2018 Cabrera D28/48
D837,452 S * 1/2019 Goeder D28/47
D843,658 S * 3/2019 Kong D28/48
D861,251 S * 9/2019 Cabrera D28/46
D863,681 S * 10/2019 Jin D28/48
D864,482 S * 10/2019 Goeder D28/48

* cited by examiner

Primary Examiner — Jennifer Rivard

(74) *Attorney, Agent, or Firm* — The H.T. Than Law Group

(57) **CLAIM**

We claim the ornamental design for a shaver handle, as shown and described.

DESCRIPTION

FIG. 1 is a top perspective view of another embodiment of the ornamental design for a shaver handle with at least one translucent member according to the present invention; FIG. 2 is a bottom perspective view thereof; FIG. 3 is an end view thereof; FIG. 4 is the opposite end view thereof; FIG. 5 is a left view thereof; FIG. 6 is a right side view thereof; FIG. 7 is a top view thereof; and, FIG. 8 is a bottom view thereof. The broken lines illustrate portions of the shaver handle and illustrate contour lines that form no part of the claimed design.

1 Claim, 5 Drawing Sheets

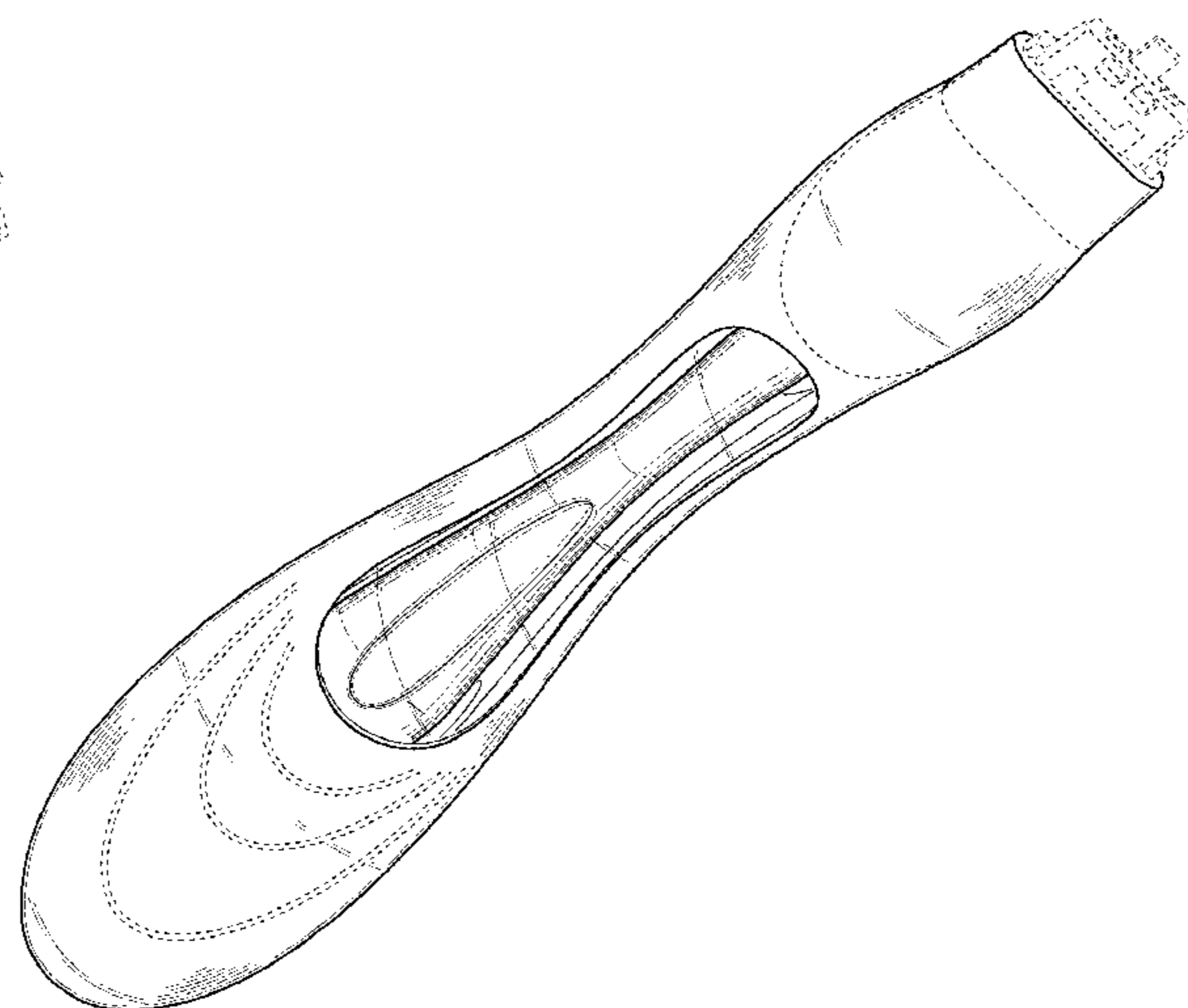
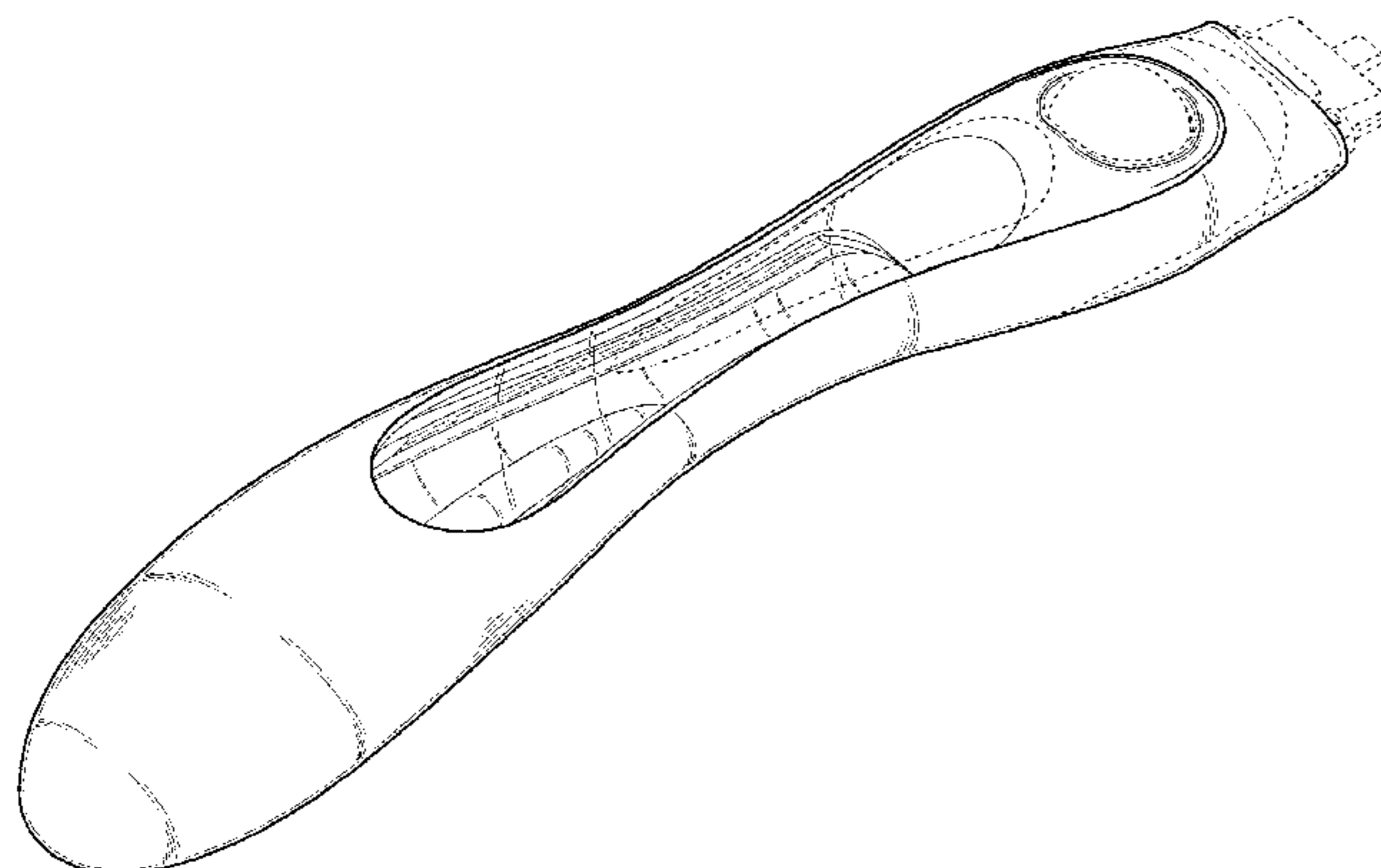

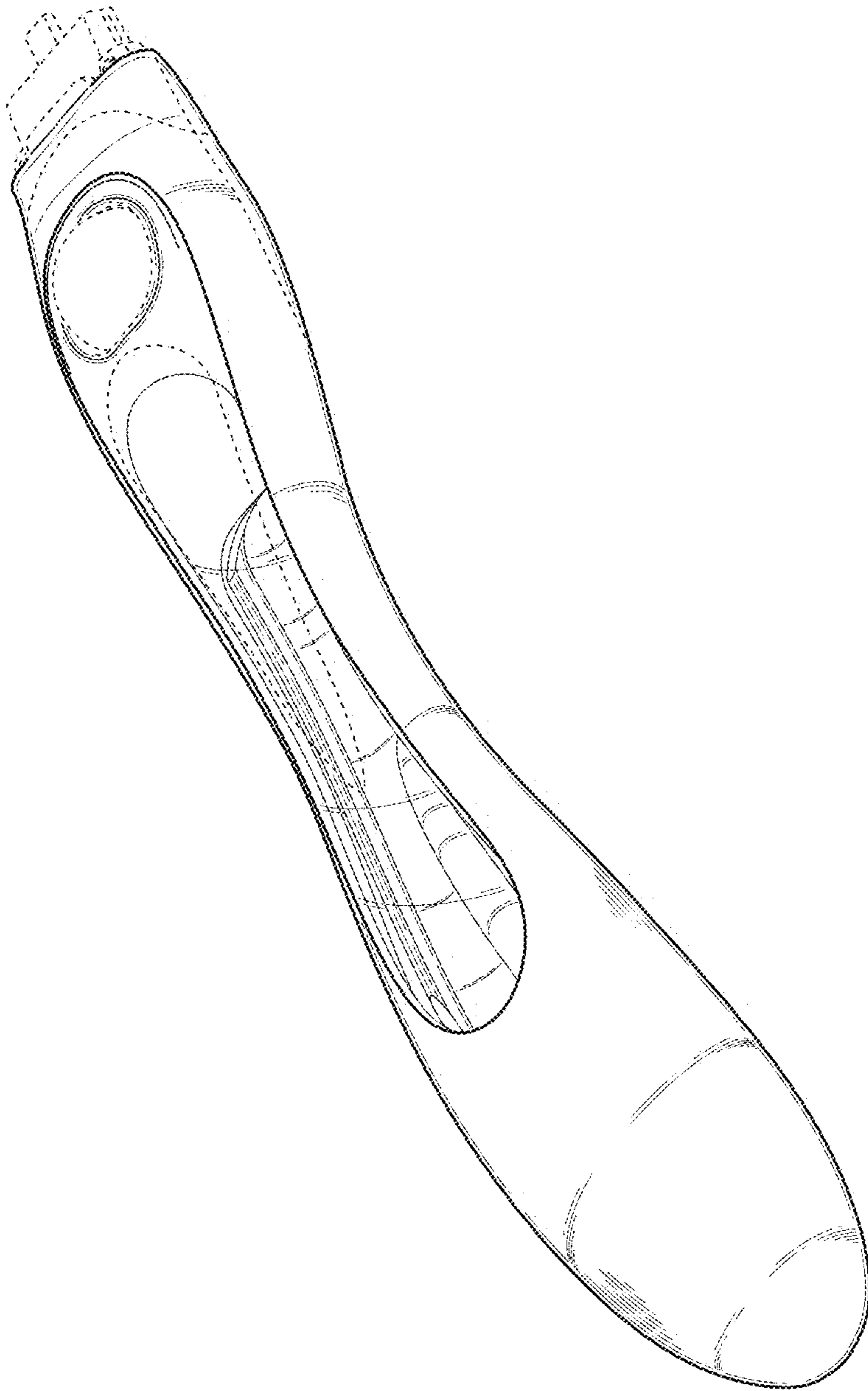

Fig. 1

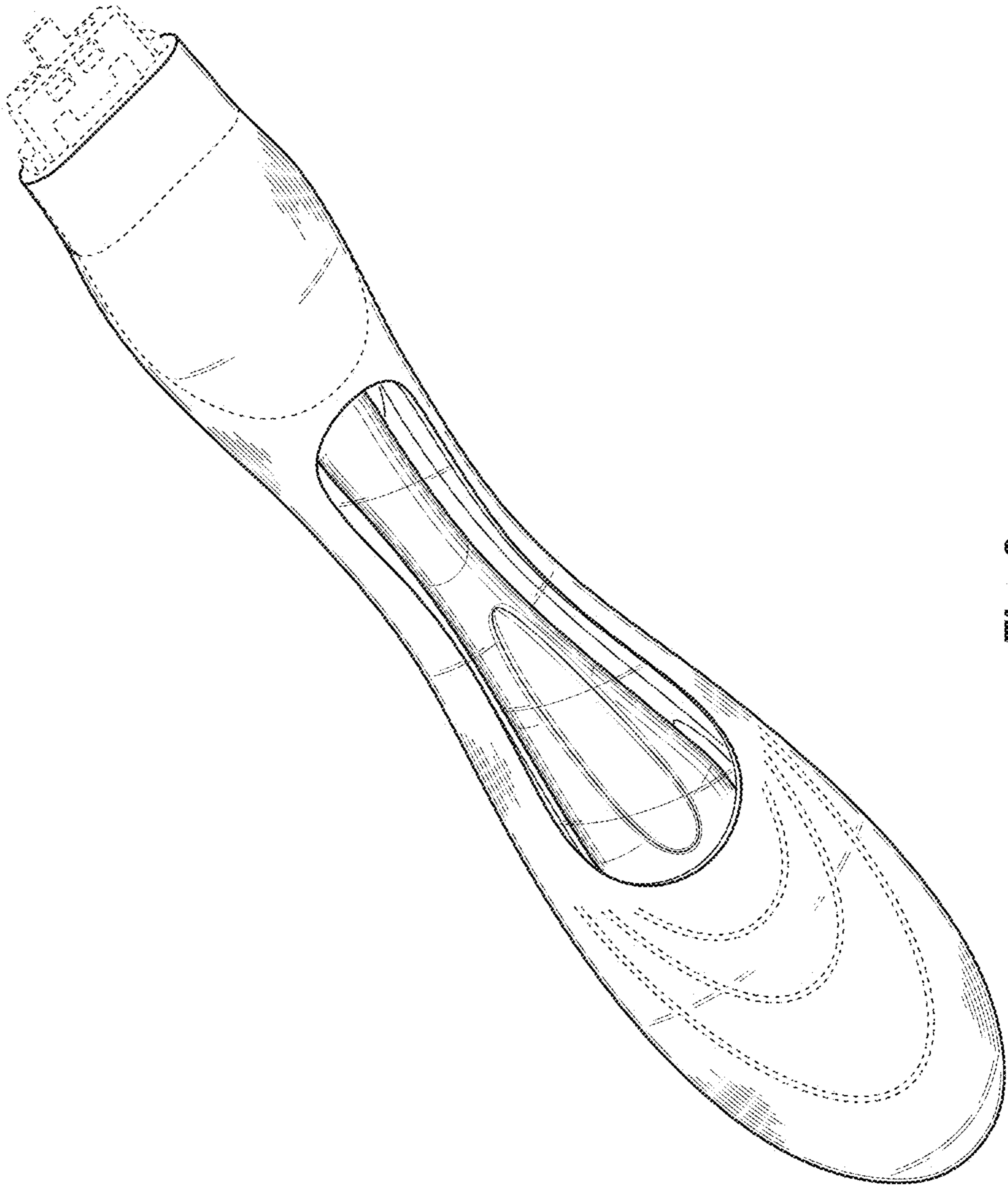

Fig. 2

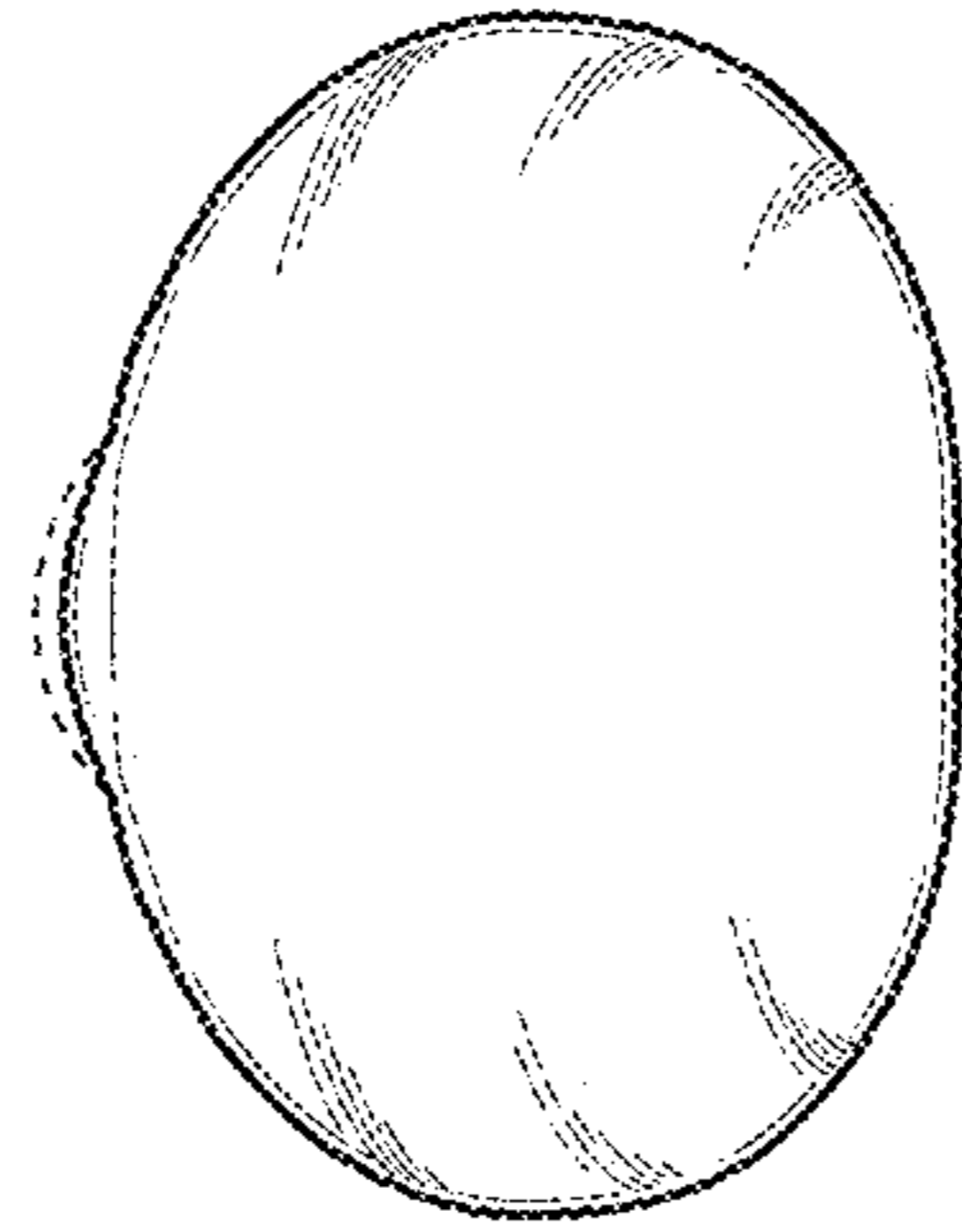

Fig. 4

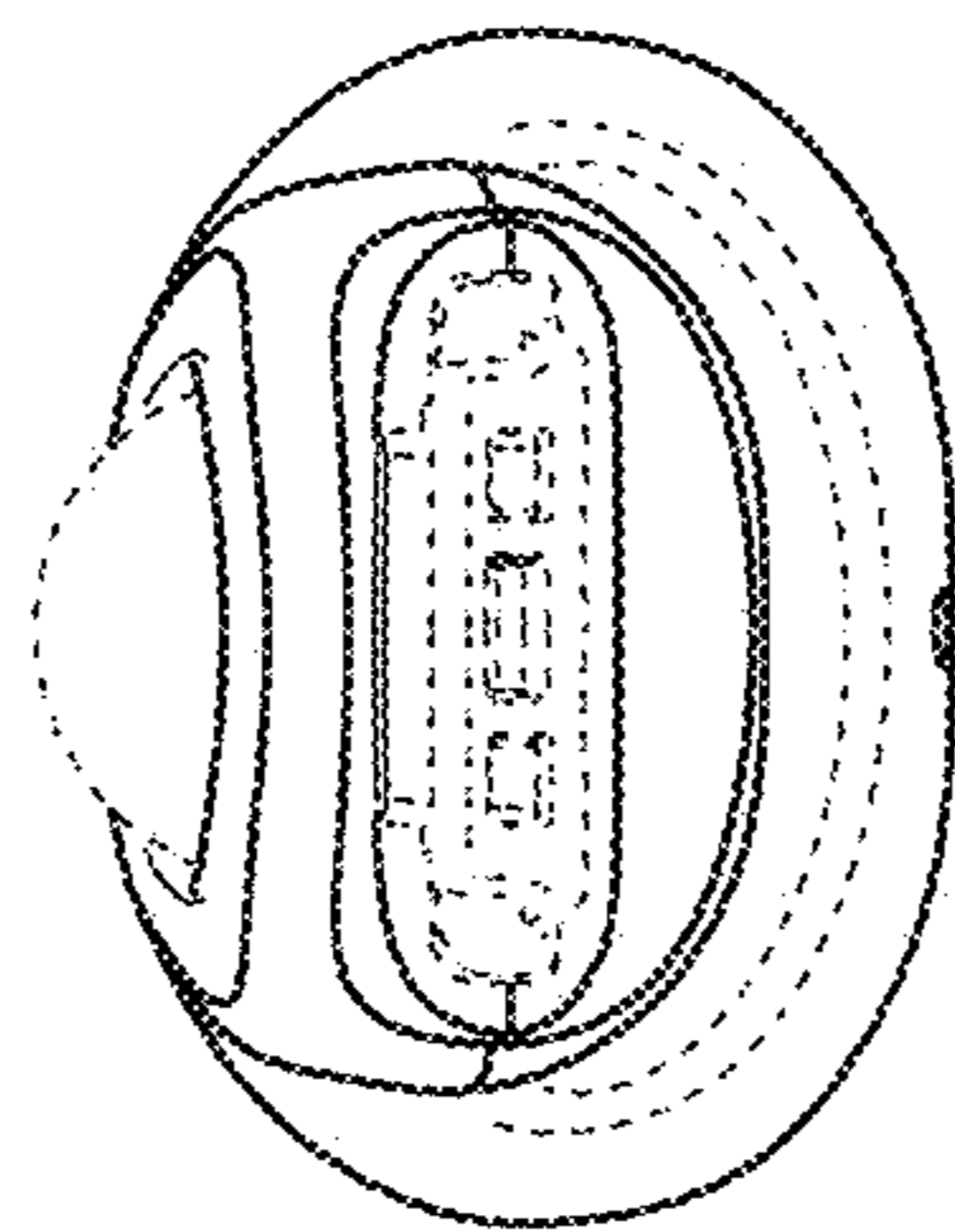

Fig. 3

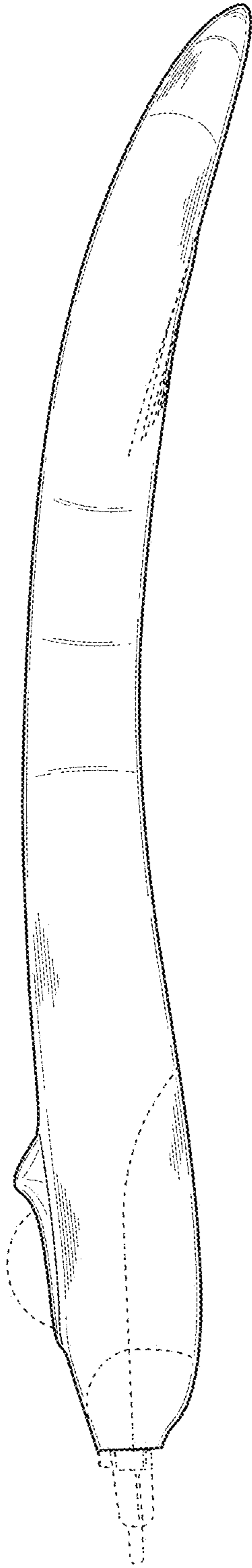

Fig. 5

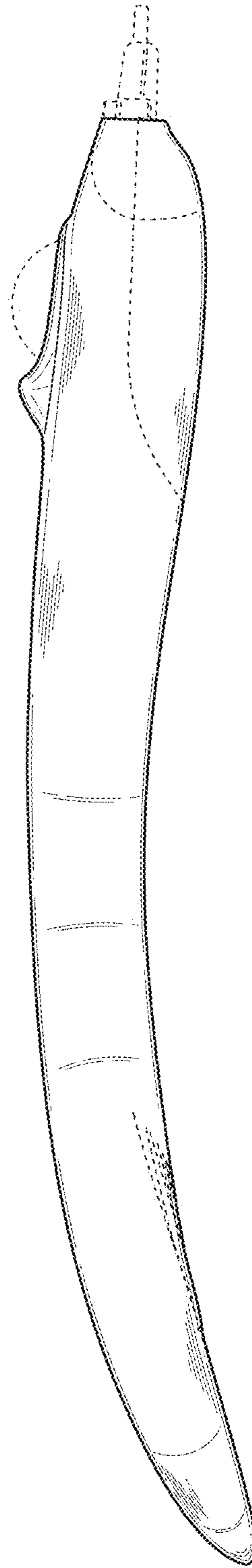

Fig. 6

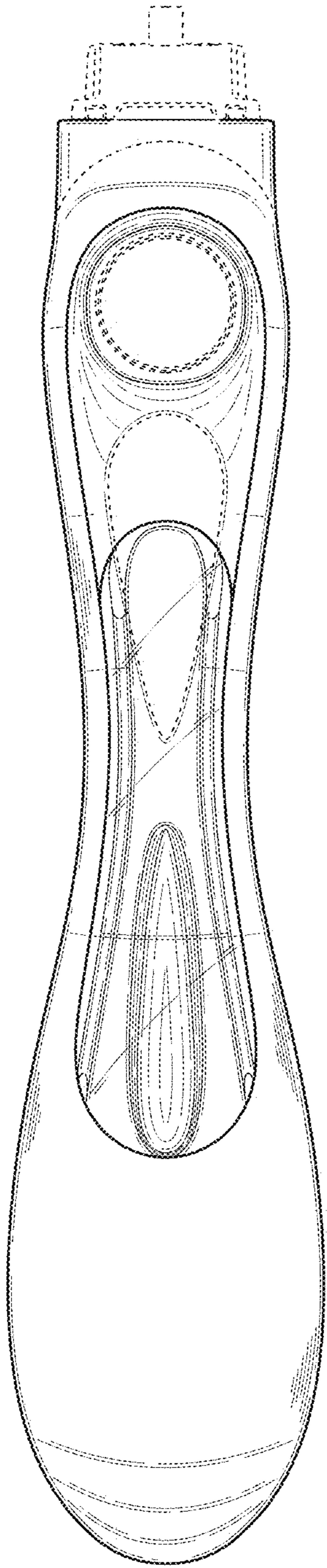

Fig. 7

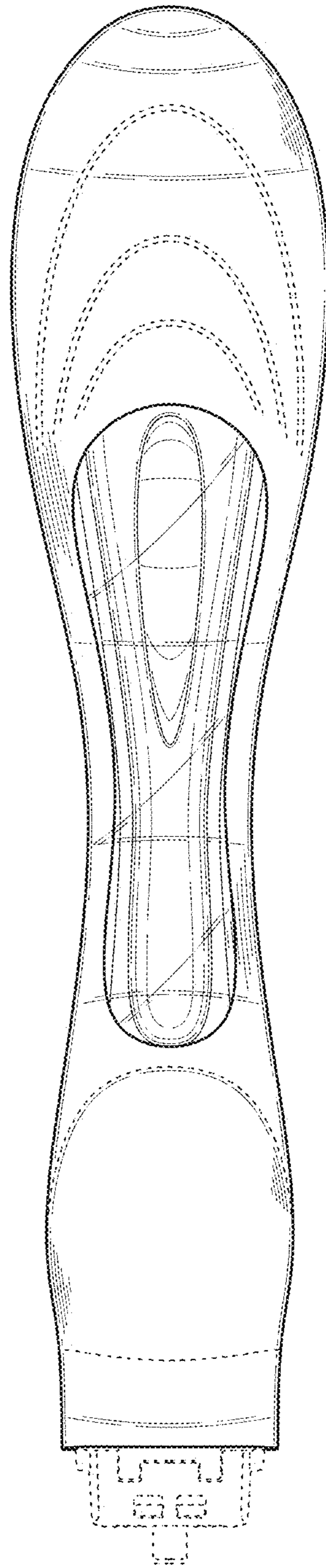

Fig. 8