



US00D883494S

(12) **United States Design Patent** (10) **Patent No.:** **US D883,494 S**
Luo et al. (45) **Date of Patent:** **** May 5, 2020**

(54) **ULTRASONIC PROBE**

(56) **References Cited**

(71) Applicant: **EDAN INSTRUMENTS, INC.**,
Shenzhen (CN)

(72) Inventors: **Hua Luo**, Shenzhen (CN); **Minkang Peng**, Shenzhen (CN); **Richard Henderson**, Sunnyvale, CA (US); **Dan Zhou**, Shenzhen (CN); **Jianhua Mo**, Shenzhen (CN); **Bo Ouyang**, Shenzhen (CN); **Jun Chen**, Shenzhen (CN)

U.S. PATENT DOCUMENTS

D609,352 S * 2/2010 Kitayama D24/186
D679,021 S * 3/2013 Tani D24/187
D701,608 S * 3/2014 Baba D24/187
D703,820 S * 4/2014 Moon D24/187
D745,175 S * 12/2015 Kitayama D24/187
D791,330 S * 7/2017 Moon D24/187
D816,851 S * 5/2018 Asai D24/187
2013/0226004 A1 * 8/2013 Lee A61B 8/00
600/459
2016/0317124 A1 * 11/2016 Henderson A61B 8/4405

(73) Assignee: **Edan Instruments, Inc.**, Shenzhen (CN)

* cited by examiner

(**) Term: **15 Years**

Primary Examiner — Anhdao Doan

(21) Appl. No.: **29/668,912**

(74) *Attorney, Agent, or Firm* — Rankin, Hill & Clark LLP

(22) Filed: **Nov. 2, 2018**

(57) **CLAIM**

The ornamental design for an ultrasonic probe, as shown and described.

(30) **Foreign Application Priority Data**

DESCRIPTION

May 24, 2018 (CN) 2018 3 0246121

(51) **LOC (12) Cl.** **24-01**

(52) **U.S. Cl.**
USPC **D24/187**

(58) **Field of Classification Search**
USPC D24/133, 137, 158, 186, 187; D10/78
CPC A61B 8/445; A61B 8/4455; A61B 8/4461
See application file for complete search history.

FIG. 1 is a perspective view of an ultrasonic probe;
FIG. 2 is a front view of the ultrasonic probe;
FIG. 3 is a rear view of the ultrasonic probe;
FIG. 4 is a left side view of the ultrasonic probe;
FIG. 5 is a right side view of the ultrasonic probe;
FIG. 6 is a top view of the ultrasonic probe; and,
FIG. 7 is a bottom view of the ultrasonic probe.

1 Claim, 7 Drawing Sheets

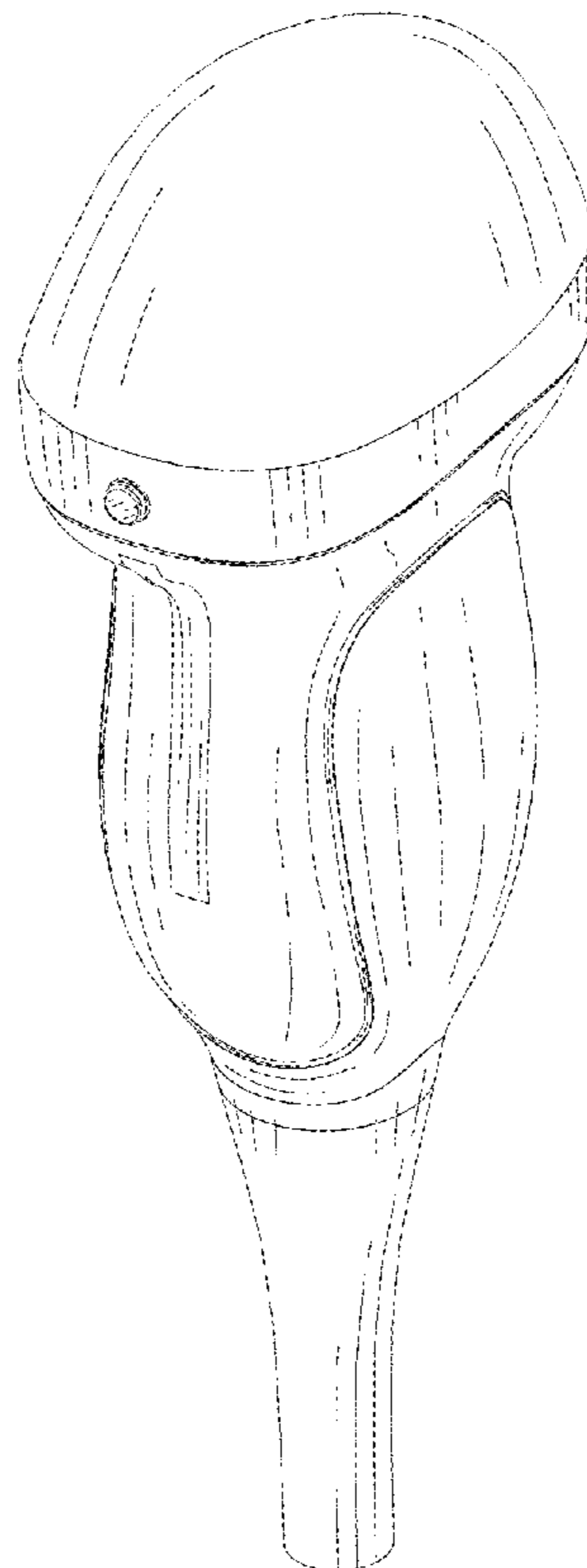

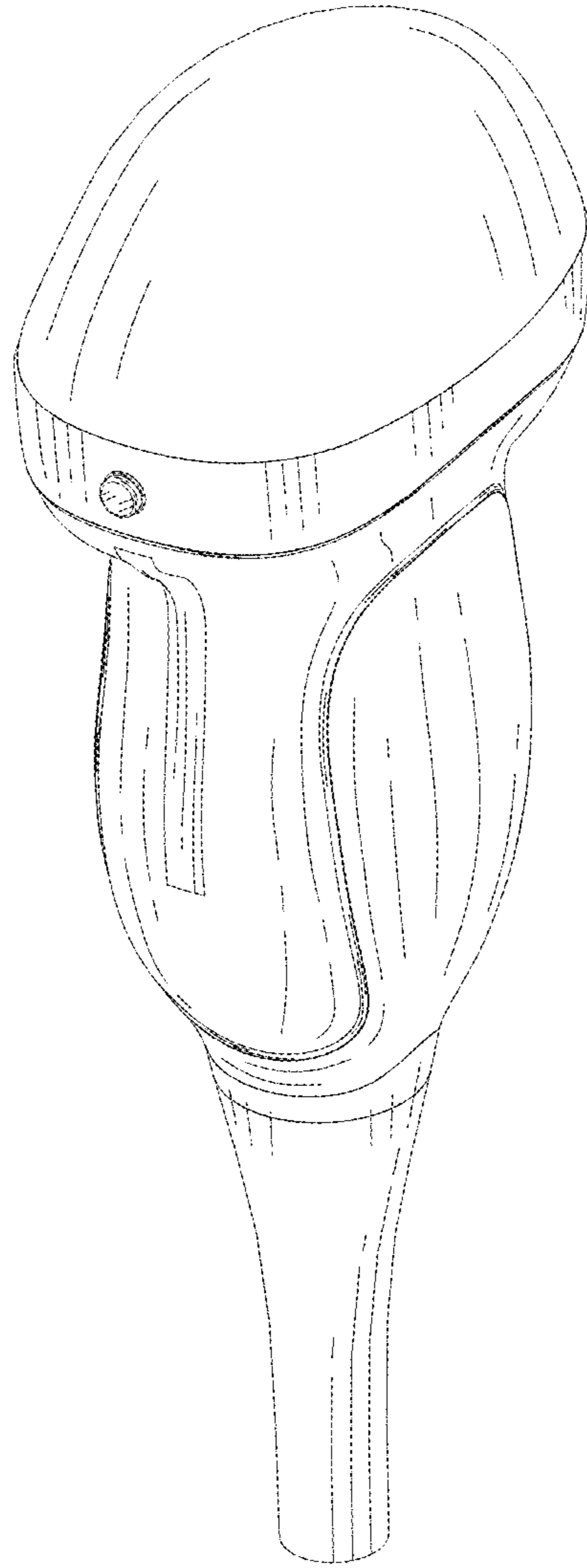

FIG. 1

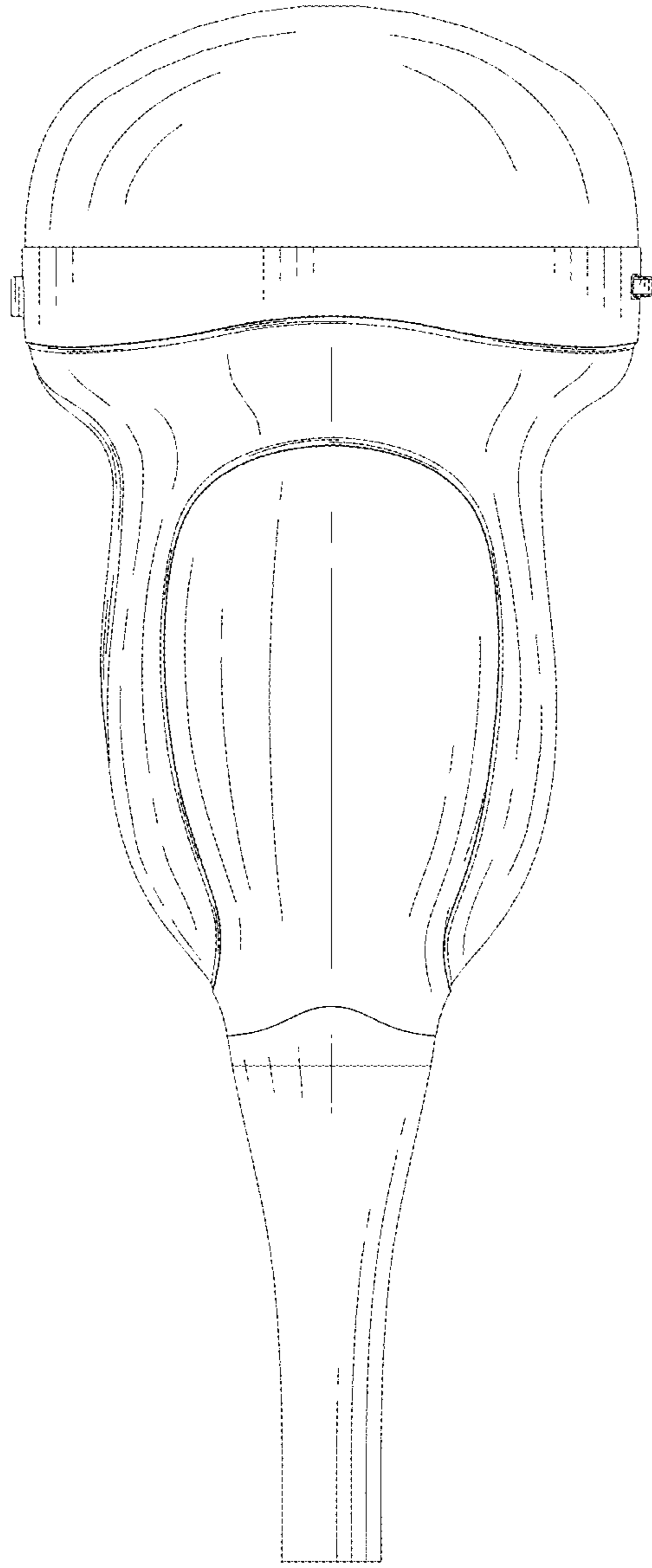

FIG. 2

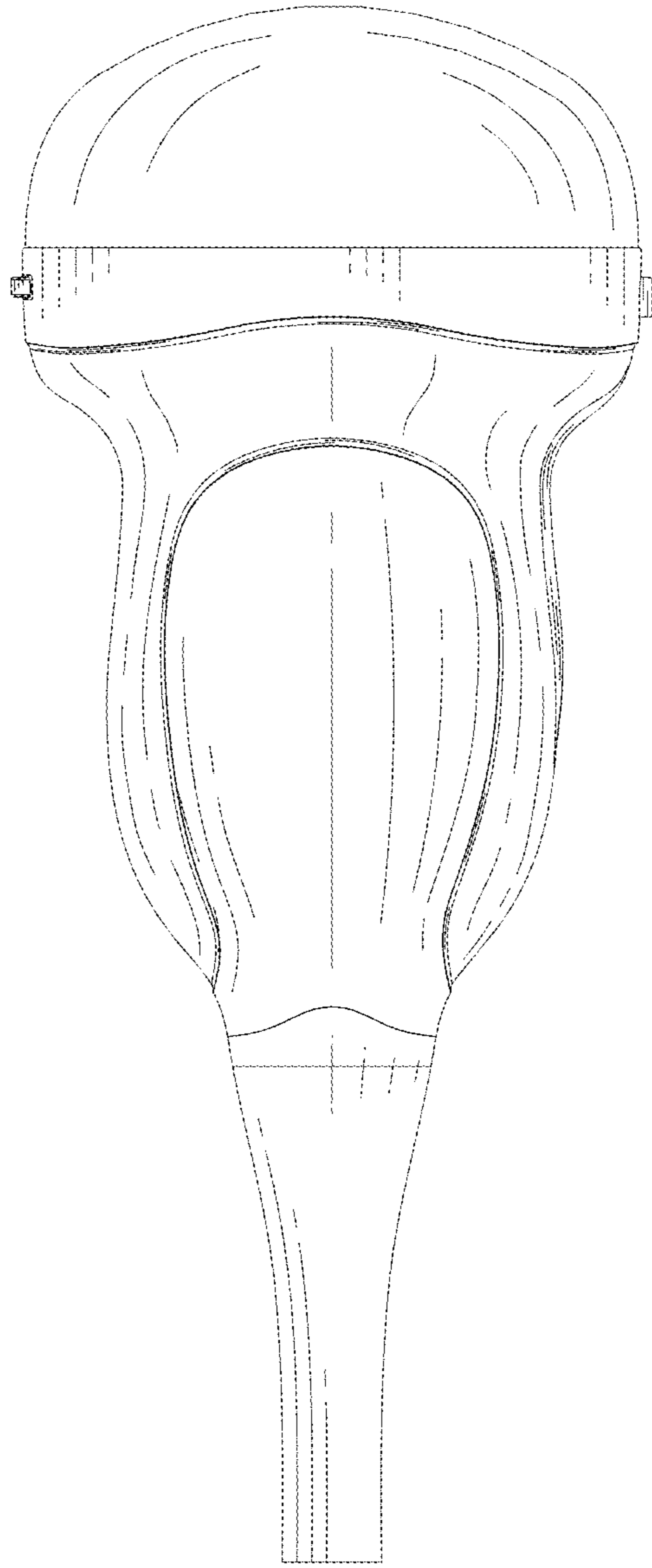

FIG. 3

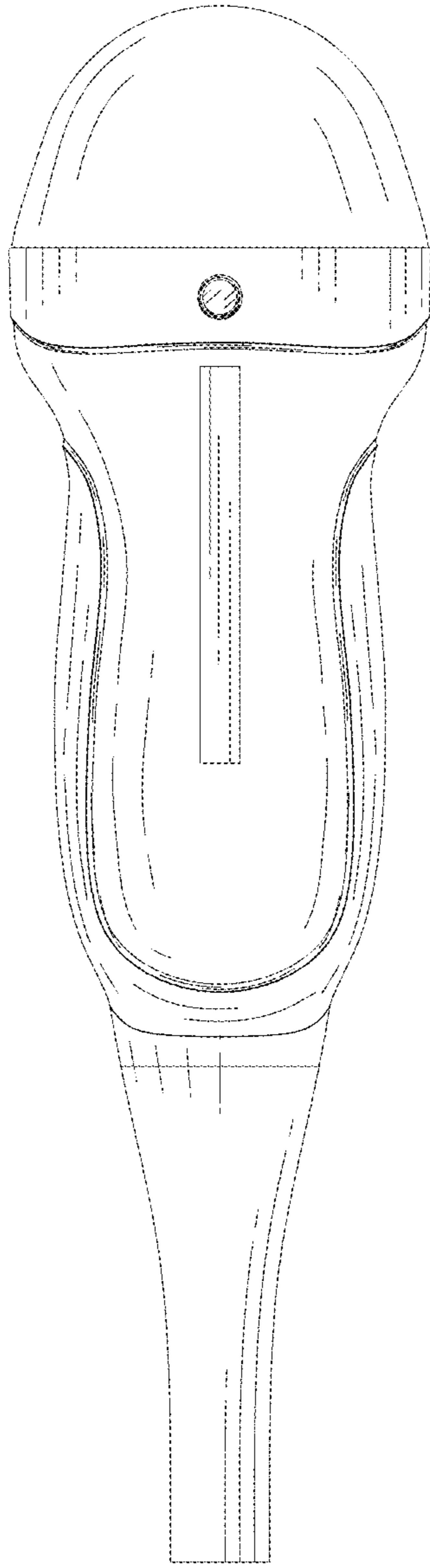

FIG. 4

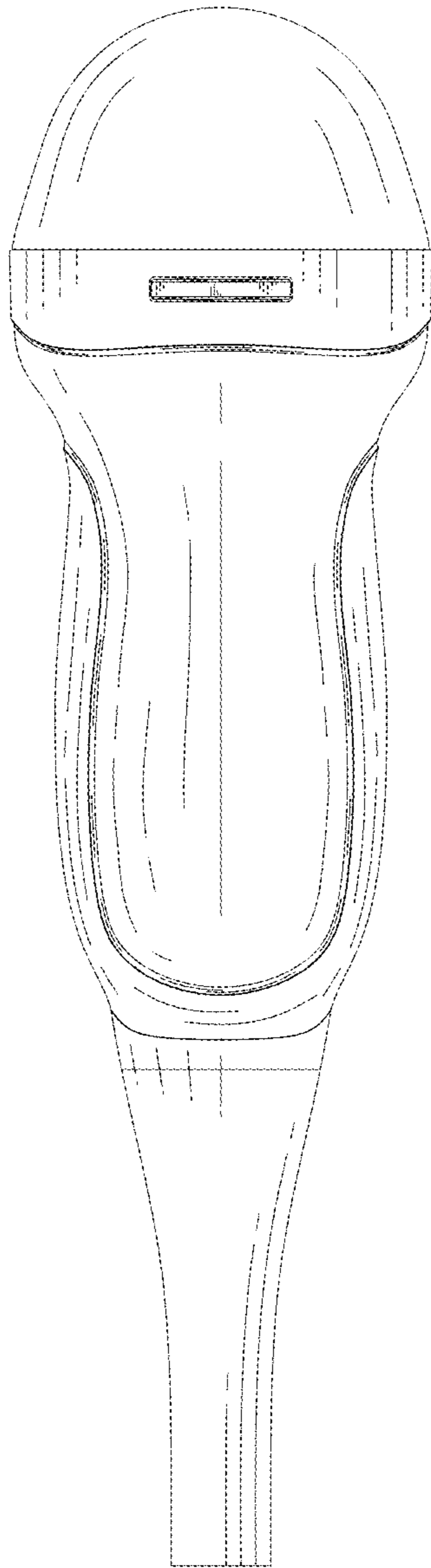

FIG. 5

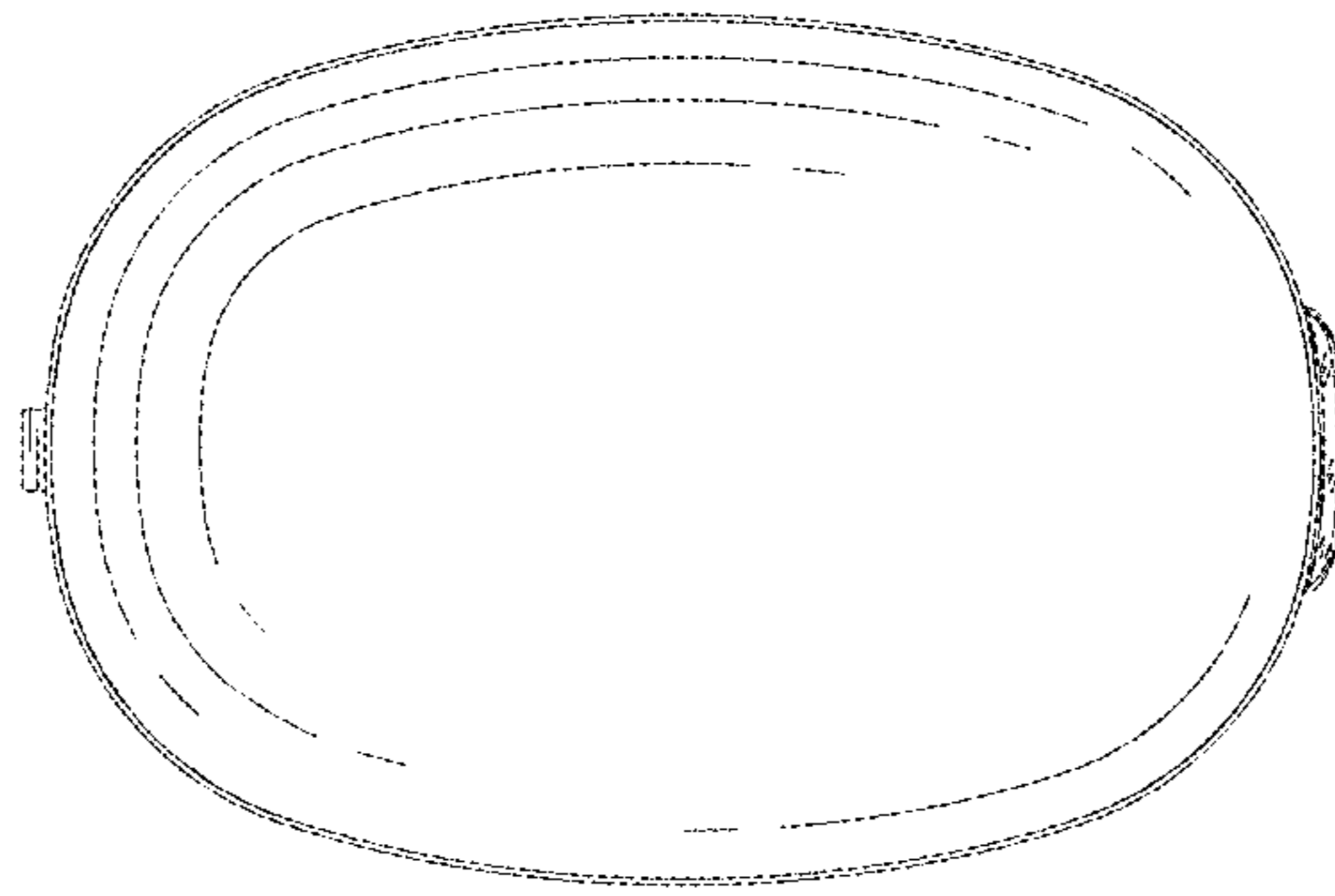

FIG. 6

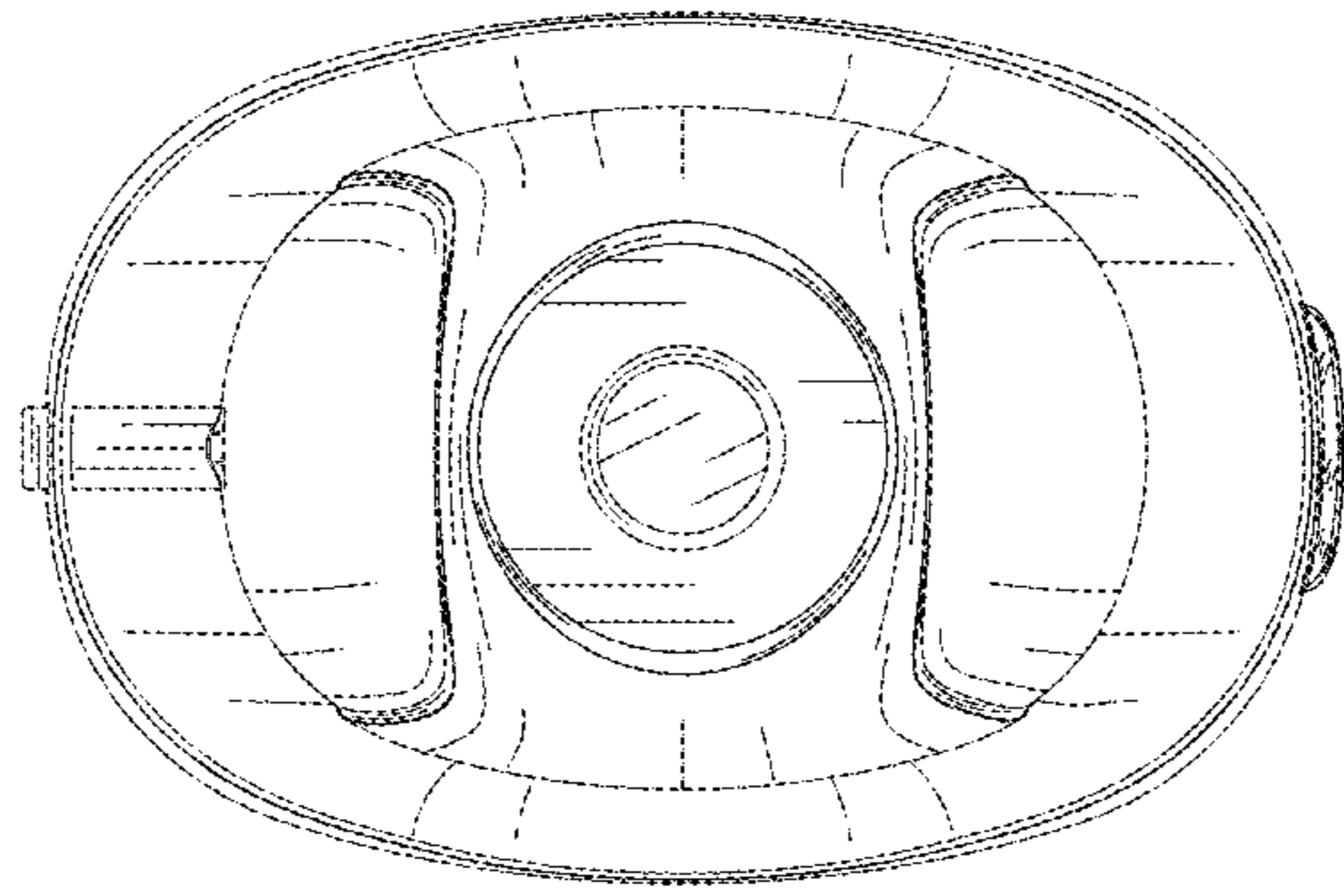

FIG. 7