



US00D883285S

(12) **United States Design Patent**
Hackett et al.

(10) **Patent No.:** **US D883,285 S**

(45) **Date of Patent:** **** May 5, 2020**

(54) **MOBILE COMPUTING DEVICE**

Primary Examiner — Susan Moon Lee

(71) Applicant: **SYMBOL TECHNOLOGIES, LLC**,
Lincolnshire, IL (US)

(57) **CLAIM**

We claim the ornamental design for a mobile computing device, as shown and described.

(72) Inventors: **Edward Anthony Hackett**, Surbiton (GB); **JaeHo Choi**, Whitestone, NY (US); **Sunghun Lim**, Bethpage, NY (US); **Chandra M. Nair**, Mount Sinai, NY (US); **Andrew Ellis**, Kitchener (CA)

DESCRIPTION

(73) Assignee: **Symbol Technologies, LLC**, Holtsville, NY (US)

(**) Term: **15 Years**

(21) Appl. No.: **29/622,110**

(22) Filed: **Oct. 13, 2017**

(51) **LOC (12) Cl.** **14-02**

(52) **U.S. Cl.**
USPC **D14/426**

(58) **Field of Classification Search**
USPC D14/420, 426–430, 453, 346, 341, 347, D14/412, 138; D13/107, 184; 358/473;
(Continued)

FIG. 1 is a first perspective view of a mobile computing device;
FIG. 2 is a second perspective view thereof;
FIG. 3 is a bottom view thereof;
FIG. 4 is a top view thereof;
FIG. 5 is a first side view thereof;
FIG. 6 is a second side view thereof;
FIG. 7 is a front view thereof; and
FIG. 8 is a rear view thereof.
FIG. 9 is a first perspective view of the mobile computing device according to a second embodiment;
FIG. 10 is a second perspective view thereof;
FIG. 11 is a bottom view thereof;
FIG. 12 is a top view thereof;
FIG. 13 is a first side view thereof;
FIG. 14 is a second side view thereof;
FIG. 15 is a front view thereof; and
FIG. 16 is a rear view thereof.
FIG. 17 is a first perspective view of the mobile computing device according to a third embodiment;
FIG. 18 is a second perspective view thereof;
FIG. 19 is a bottom view thereof;
FIG. 20 is a top view thereof;
FIG. 21 is a first side view thereof;
FIG. 22 is a second side view thereof;
FIG. 23 is a front view thereof; and,
FIG. 24 is a rear view thereof.

(56) **References Cited**

U.S. PATENT DOCUMENTS

D392,282 S * 3/1998 Ahearn D14/346
5,801,918 A * 9/1998 Ahearn G06K 7/10881
235/472.01

(Continued)

OTHER PUBLICATIONS

MC32No Series Quick Start Guide, retrieved from the Internet on Nov. 9, 2017 from <https://www.zebra.com/content/dam/zebra_new_ia/en-us/manuals/mobile-computers/mc3200-quick-start-guide-en-us.pdf>.

(Continued)

The broken lines are directed to environment and are for illustrative purposes only. Broken lines of a particular embodiment form no part of the design claimed in that particular embodiment.

1 Claim, 21 Drawing Sheets

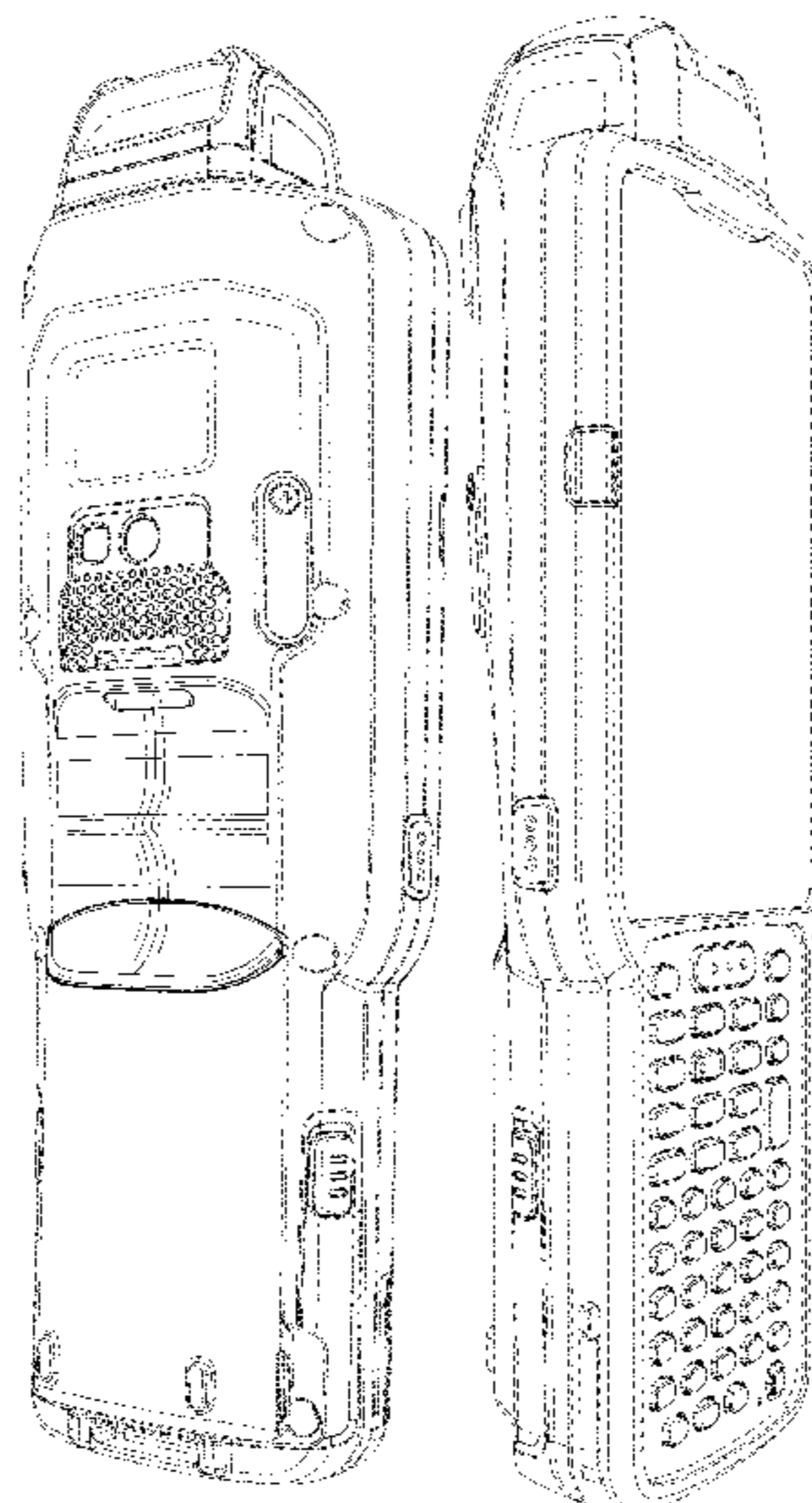

(58) **Field of Classification Search**

USPC 235/462.43, 462.45, 462.47, 462.48,
 235/462.44, 462.46, 487, 472.01, 472.02,
 235/145 A, 145 R; D10/78, 57, 2, 46, 52,
 D10/53, 81; 324/426; D3/273; 710/73;
 D18/7; 361/679, 728, 679.56; 382/313,
 382/321; 455/575.1, 561, 572, 41.2;
 345/156, 168, 169, 172, 173, 87; 705/17,
 705/18, 22-25; D16/206, 218, 202, 219,
 D16/208, 209; 356/328; 396/419, 423,
 396/424; 374/130, 100, 121, 102, 141,
 374/124, 170, 104, 103; 702/130, 135;
 348/164, 165, 149, 333.01, 333.11,
 348/E5.043, E5.047, E5.09, 33, 82, 347,
 348/E5.028, 373, 374, 375; 250/330,
 250/351, 353, 332, 334, 358.1, 316.1,
 250/338.1; 600/549, 474, 413, 473, 200,
 600/184
 CPC G06F 1/626; G06F 1/1626; G06F 1/1656;
 G06F 1/1632; G06F 1/1684; G06F
 1/1635; G06F 8/63; G06F 17/30091;
 G06F 9/4401; G06K 7/10881; G06K
 7/1098; G06K 7/1404; G06K 7/0004;
 G06K 7/10633; G06K 7/10851; G06K
 7/1091; G06K 7/1092; G06K 7/1093;
 G06K 7/10; G06K 7/109; G06K 7/10722;
 G06K 7/1417; G06K 9/228; G06K
 17/0022; G06K 17/00; G06K 2207/1011;
 G06K 2207/1013; G06K 2207/1016;
 G06K 2207/1018; G06K 2017/0051;
 G06K 2017/0067; G06K 2007/10524;
 G07G 1/0081; G07G 1/009; G06Q 20/20;
 G06Q 20/201; G06Q 20/202; G06Q
 20/203; G06Q 20/30; G06Q 20/32; G06Q
 20/322; G06Q 20/4014; G06Q 10/087;
 H04N 1/00127; H04N 1/00135; H04N
 1/00326; H04N 1/00334; H04N 1/00307;
 H04N 1/107; H04N 2201/0084; H04N
 2101/00; H04N 5/332; H04N 5/33; H04N
 5/2251; H04N 5/2258; H04N 5/2256;
 H04N 5/23293; H04N 5/23203; H04N
 5/2254; H04N 5/2252; H04N 5/2253;
 H04N 5/23229; H04N 5/3651; H04M
 1/0249; H04M 1/0262; H04M 1/0266;
 H04M 1/18; H04M 1/23; H04M 1/236;
 H04B 1/3827; H04B 1/3833; H04B
 1/3877; H04B 1/3883; H04B 1/3888;
 H04B 2001/3894; H01M 2/1066; G01J
 5/025; G01J 5/0265; G01J 5/026; G01J
 5/027; G01J 5/02; G01J 5/06; G01J 5/08;
 G01J 5/04; G01J 5/12; G01J 5/00; G01J
 5/18; G01J 5/0834; G01J 5/522; G01J
 5/0806; G01J 5/028; G01J 2005/0077;
 G01J 2005/0081; G02B 7/08; G02B 7/04;
 G01K 1/02; G01K 3/04; G03B 17/18;
 G03B 3/02; G03B 3/04; G03B 3/10

See application file for complete search history.

(56)

References Cited

U.S. PATENT DOCUMENTS

D400,872 S * 11/1998 Ahearn D14/453
 D414,470 S * 9/1999 Chacon D14/341
 D427,090 S * 6/2000 Washburn D10/78
 D431,562 S * 10/2000 Bhatia D14/341
 D436,104 S * 1/2001 Bhatia D14/341
 D456,806 S * 5/2002 Ahearn D14/347
 D462,357 S 9/2002 Jenkins
 D463,421 S 9/2002 Lanzaro et al.
 D463,425 S 9/2002 Jenkins
 D463,428 S 9/2002 Jenkins
 D470,842 S 2/2003 Bhatia et al.
 D476,330 S * 6/2003 Ahearn D14/347
 D492,305 S 6/2004 Choi et al.
 D505,422 S * 5/2005 Kakizaki D14/347
 D505,423 S * 5/2005 Ahearn D14/347
 D537,828 S 3/2007 Croley et al.
 D538,292 S 3/2007 Croley et al.
 D541,809 S 5/2007 Croley et al.
 D542,801 S * 5/2007 Croley D14/453
 D557,696 S * 12/2007 Conti D14/346
 D558,776 S * 1/2008 Croley D14/453
 D565,577 S * 4/2008 Hanks D14/426
 D575,287 S * 8/2008 Miyashita D14/426
 D599,798 S * 9/2009 Fitch D14/426
 D611,943 S * 3/2010 Boyd D14/346
 D613,289 S * 4/2010 Alegiani D14/426
 D614,626 S * 4/2010 Dai D14/426
 D629,001 S 12/2010 Palmer et al.
 D634,744 S * 3/2011 Palmer D14/347
 D638,422 S * 5/2011 Reed D14/347
 8,048,552 B1 * 11/2011 Mao H01M 2/1066
 429/97
 D704,711 S * 5/2014 Minafo D14/426
 D709,503 S 7/2014 Chen et al.
 D716,306 S * 10/2014 Park D14/426
 D738,762 S * 9/2015 Payne D10/78
 D739,279 S * 9/2015 Payne D10/78
 D754,663 S * 4/2016 Graves D14/426
 D771,631 S * 11/2016 Fitch D14/426
 D790,546 S * 6/2017 Zhou D14/426
 D806,592 S * 1/2018 Protti D10/78
 D842,146 S * 3/2019 Li D10/78
 D868,066 S * 11/2019 Yang D14/426
 2006/0054704 A1 * 3/2006 Fitch G06F 1/1626
 235/472.01
 2009/0168337 A1 * 7/2009 Conti G06F 1/1626
 361/679.56
 2009/0270136 A1 * 10/2009 Su H01M 2/1066
 455/572
 2013/0126616 A1 * 5/2013 Zolotov G06K 7/10722
 235/462.25

OTHER PUBLICATIONS

MC3200 Mobile Computer, Product Spec Sheet, retrieved from the Internet on Nov. 9, 2017 from <<https://www.zebra.com/us/en/products/spec-sheets-latest/mobile-computers/handheld-computers/mc3200-spec-sheet-en.html>>.
 MC3200 User Guide, Zebra Technologies, Jul. 2017.

* cited by examiner

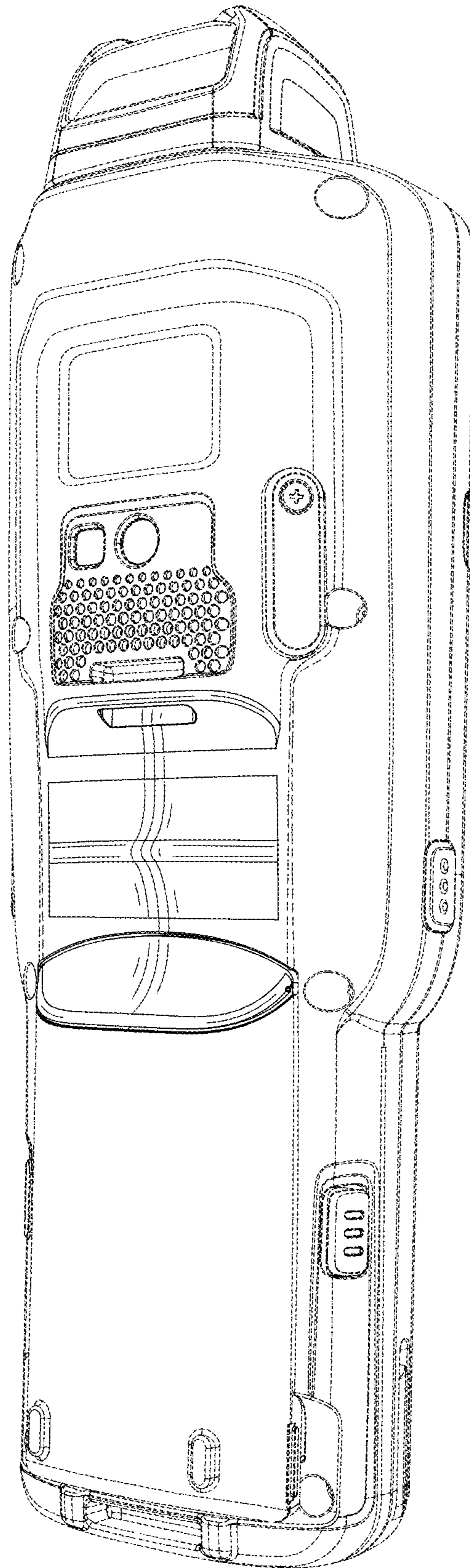

FIG. 1

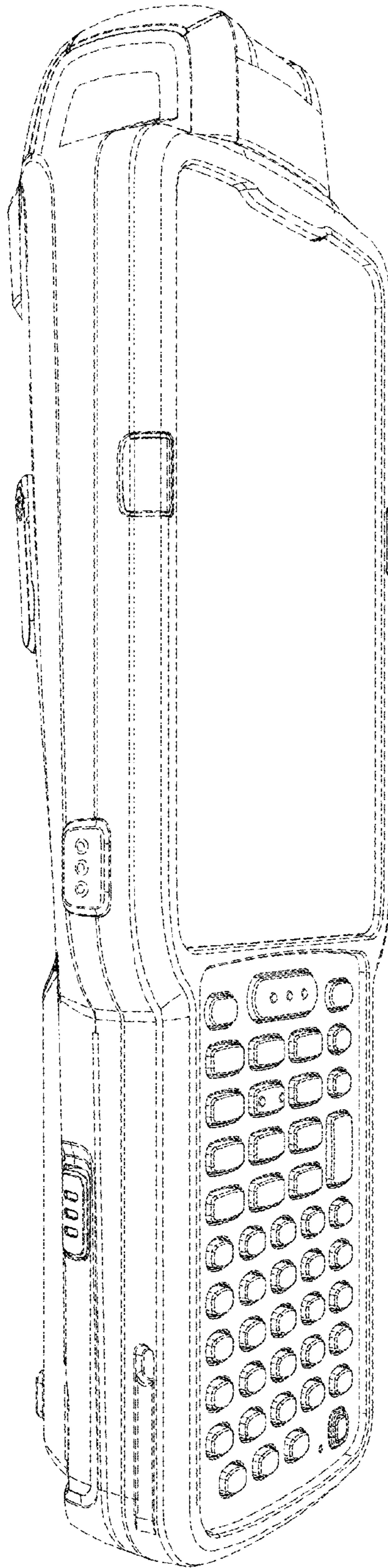

FIG. 2

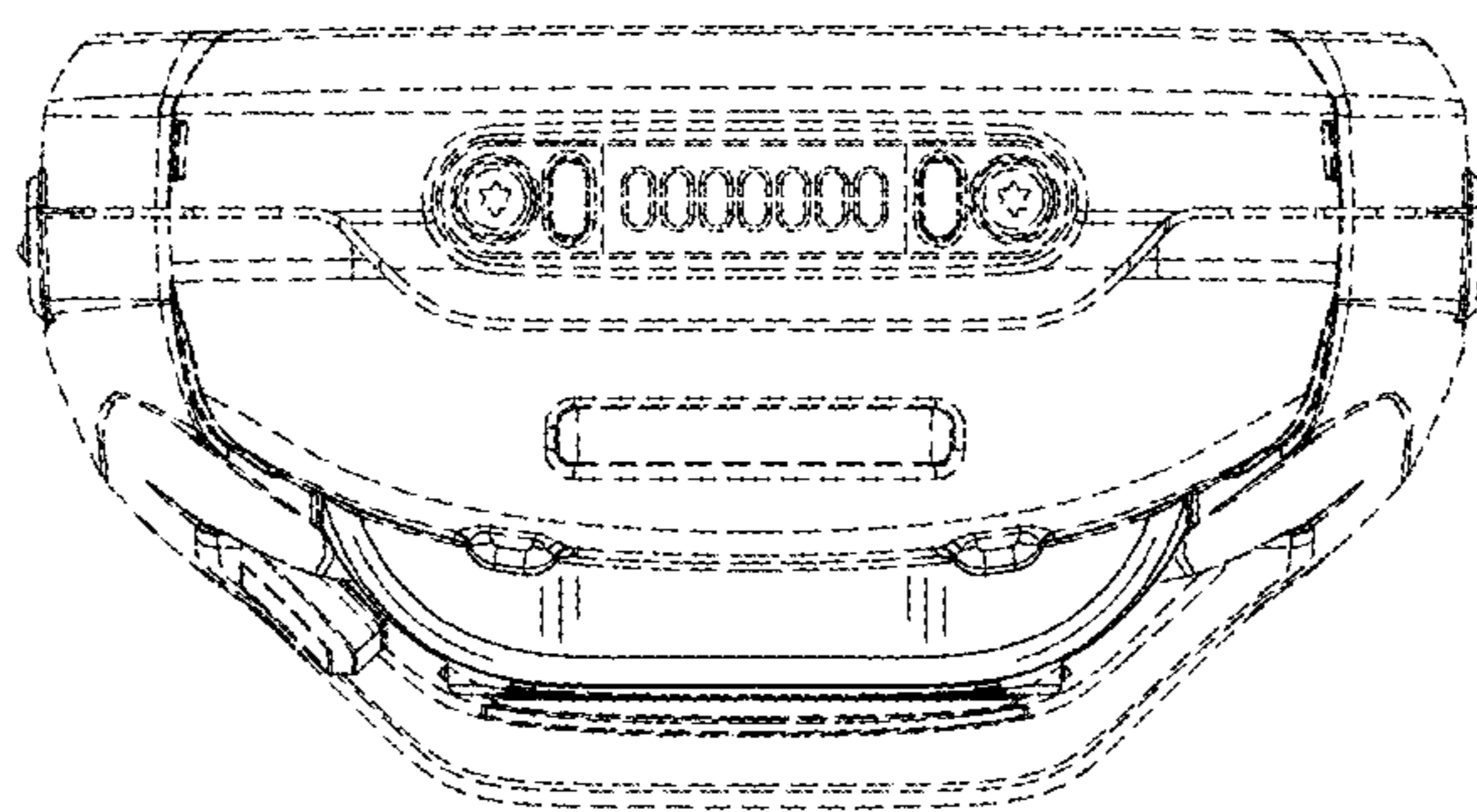

FIG. 3

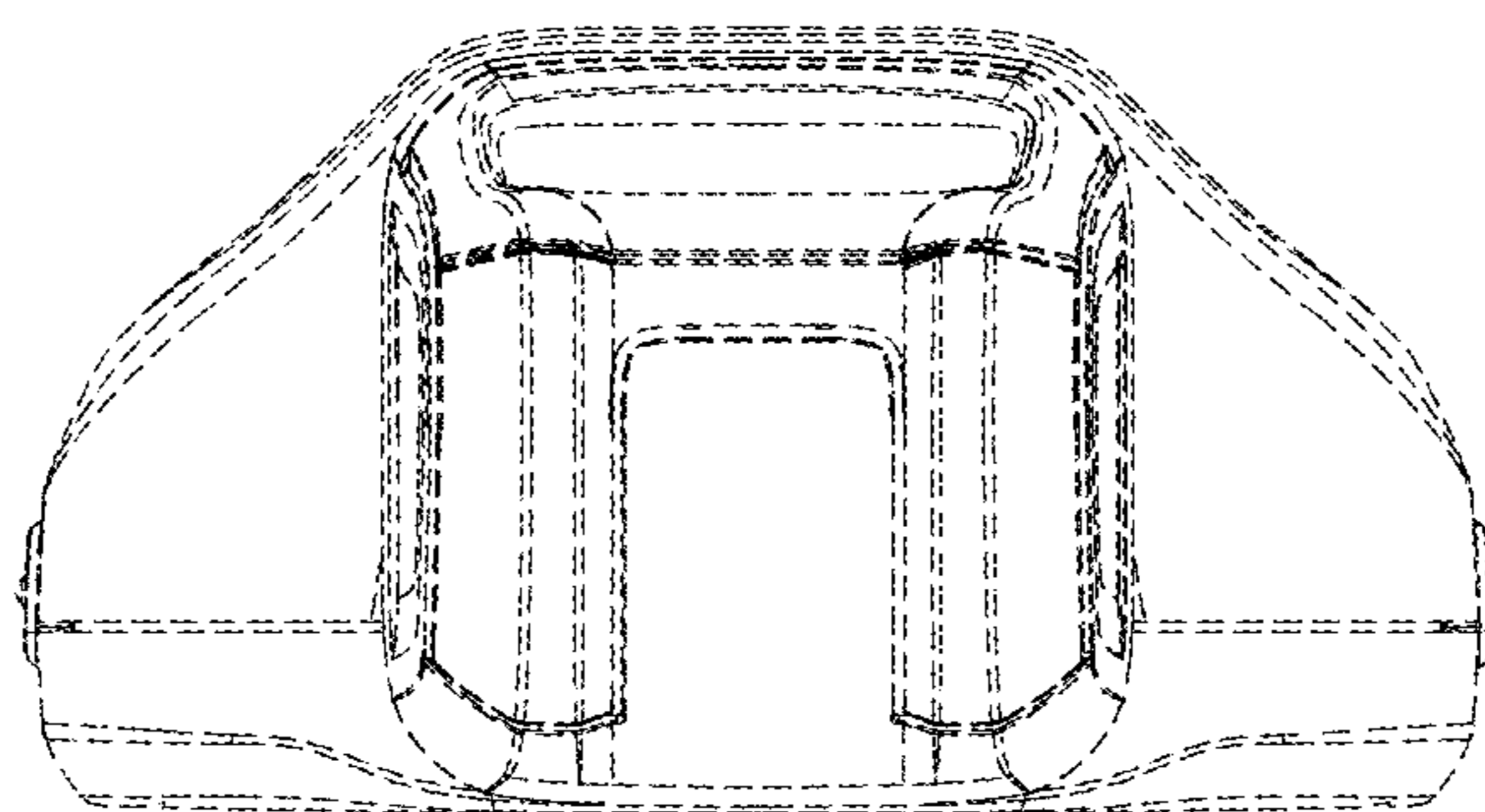

FIG. 4

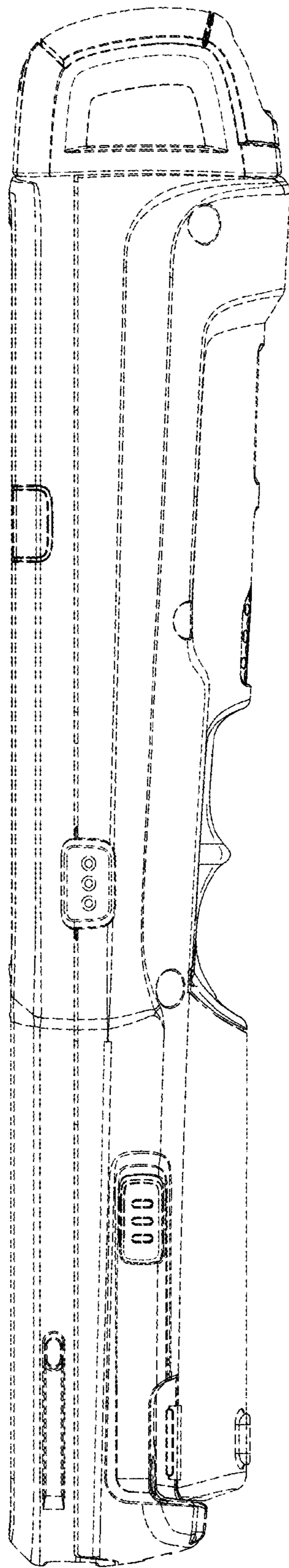

FIG. 5

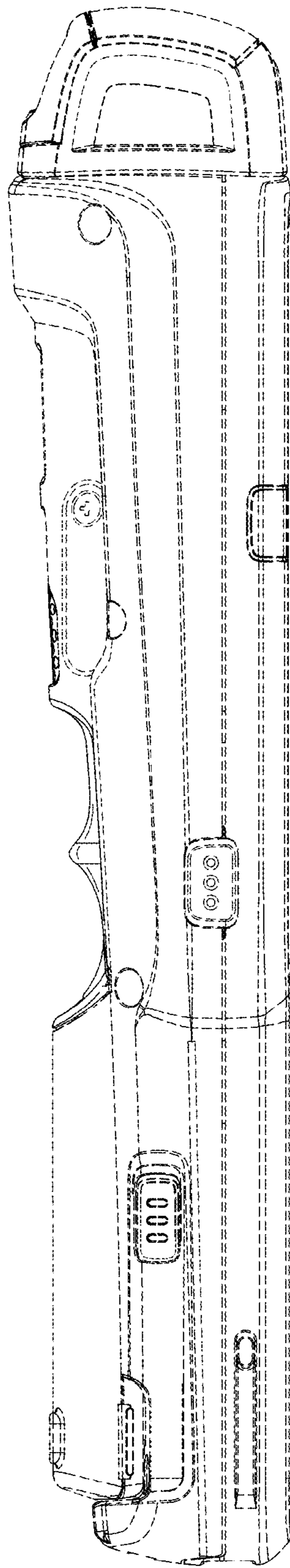

FIG. 6

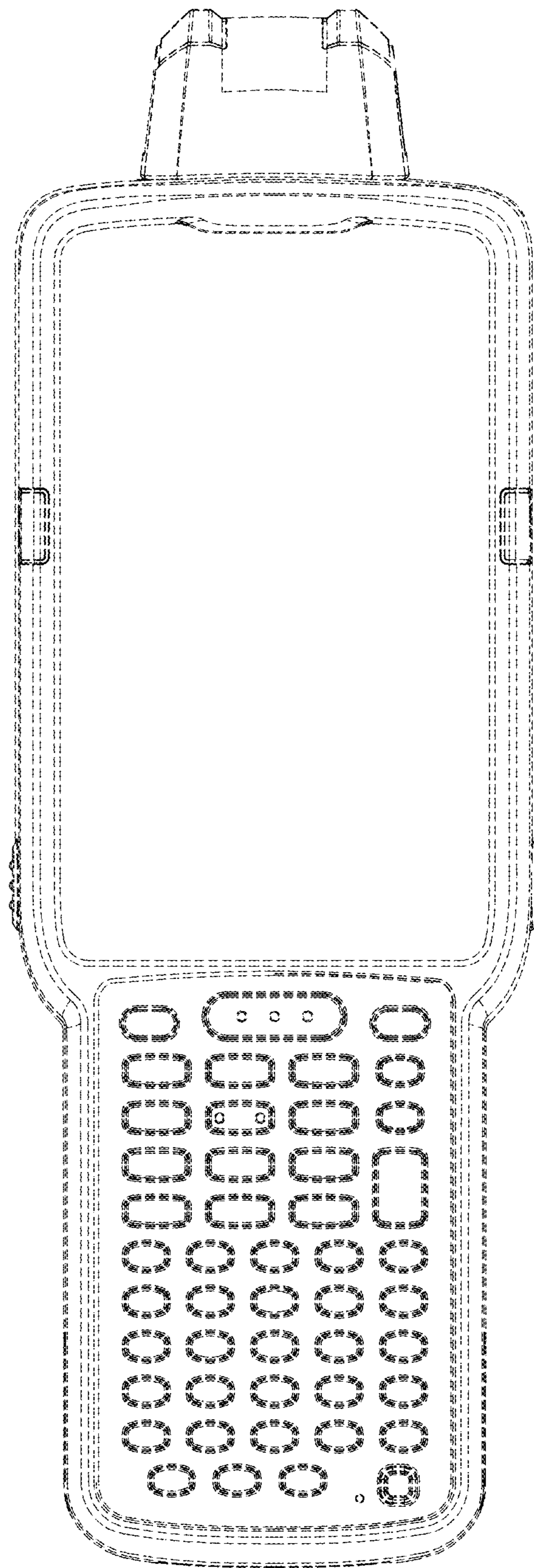

FIG. 7

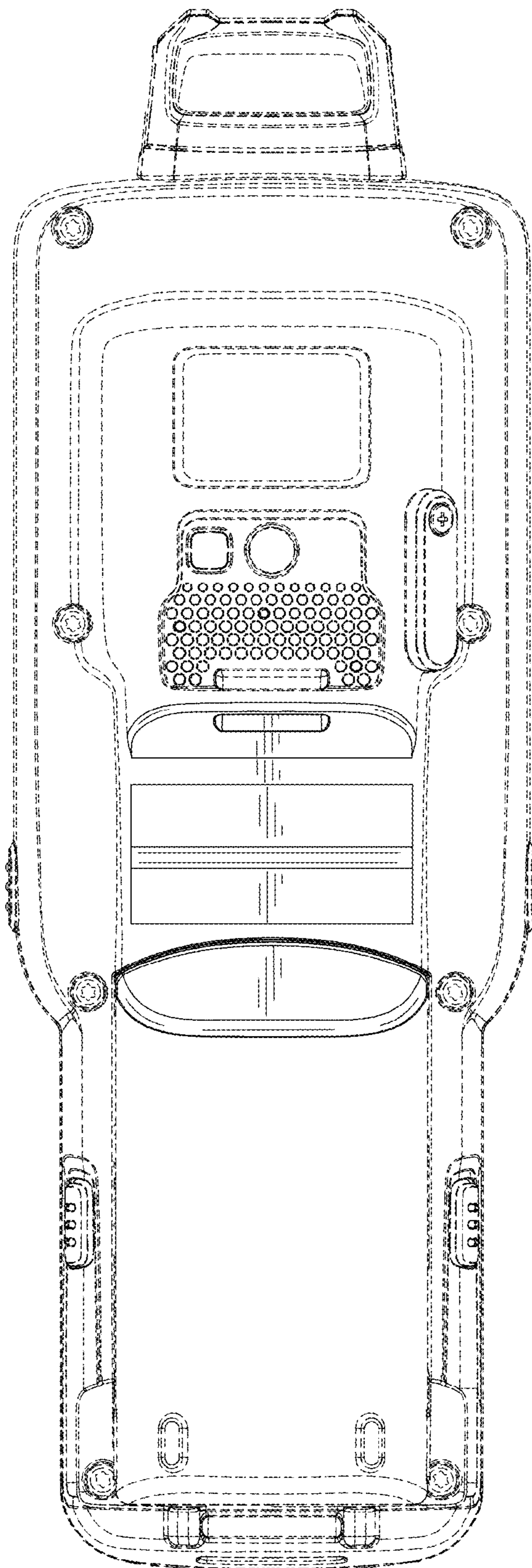

FIG. 8

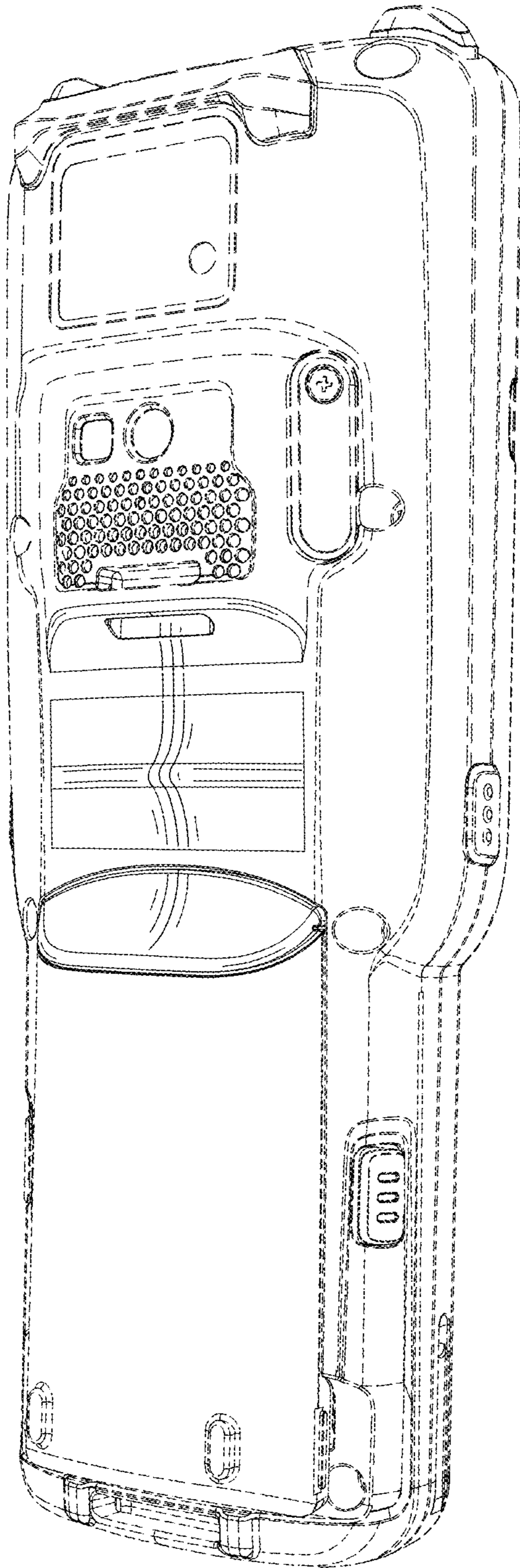

FIG. 9

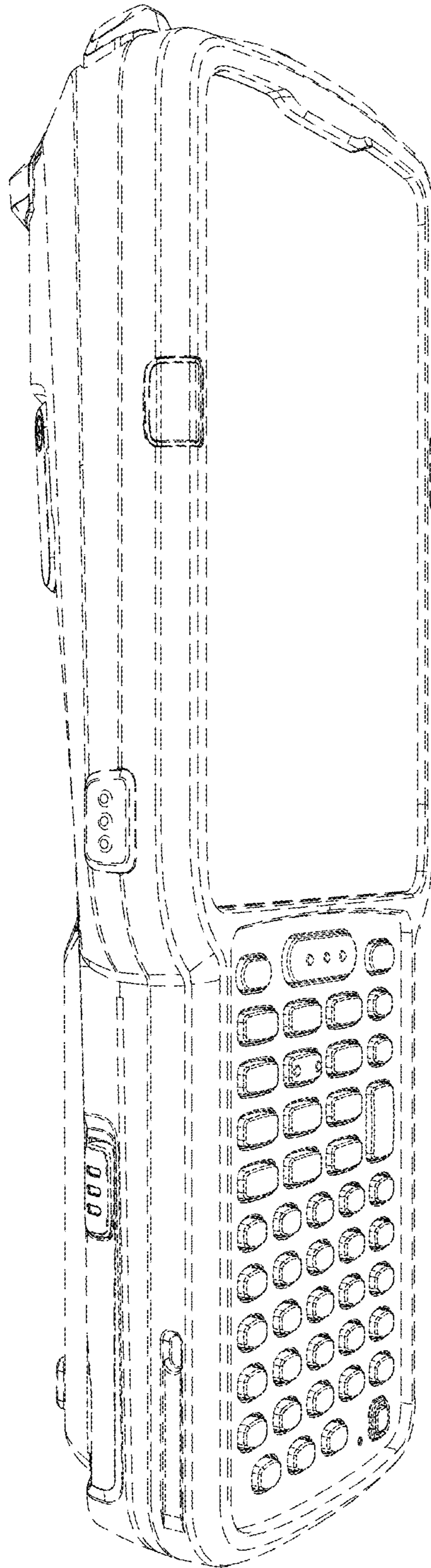

FIG. 10

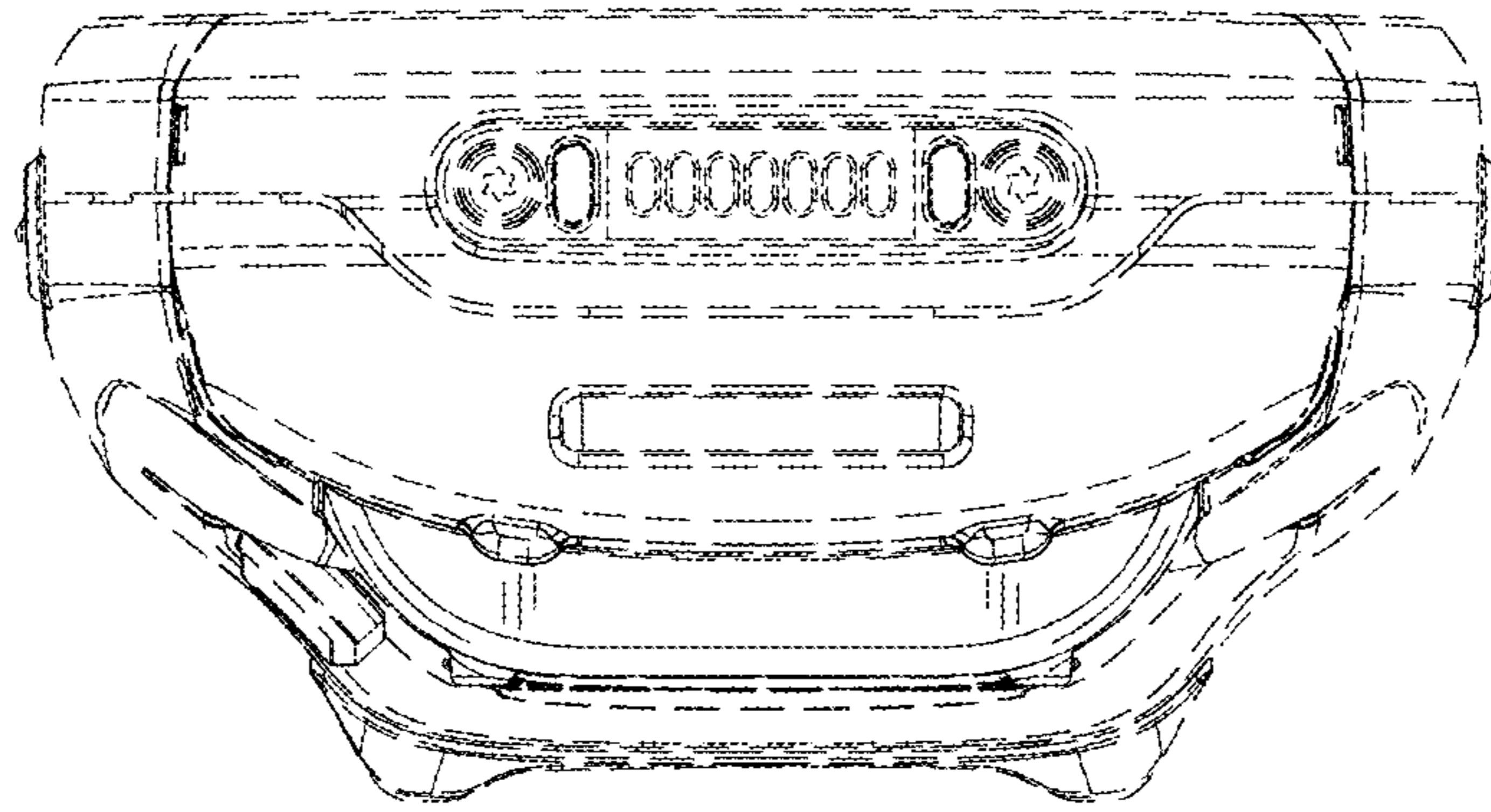

FIG. 11

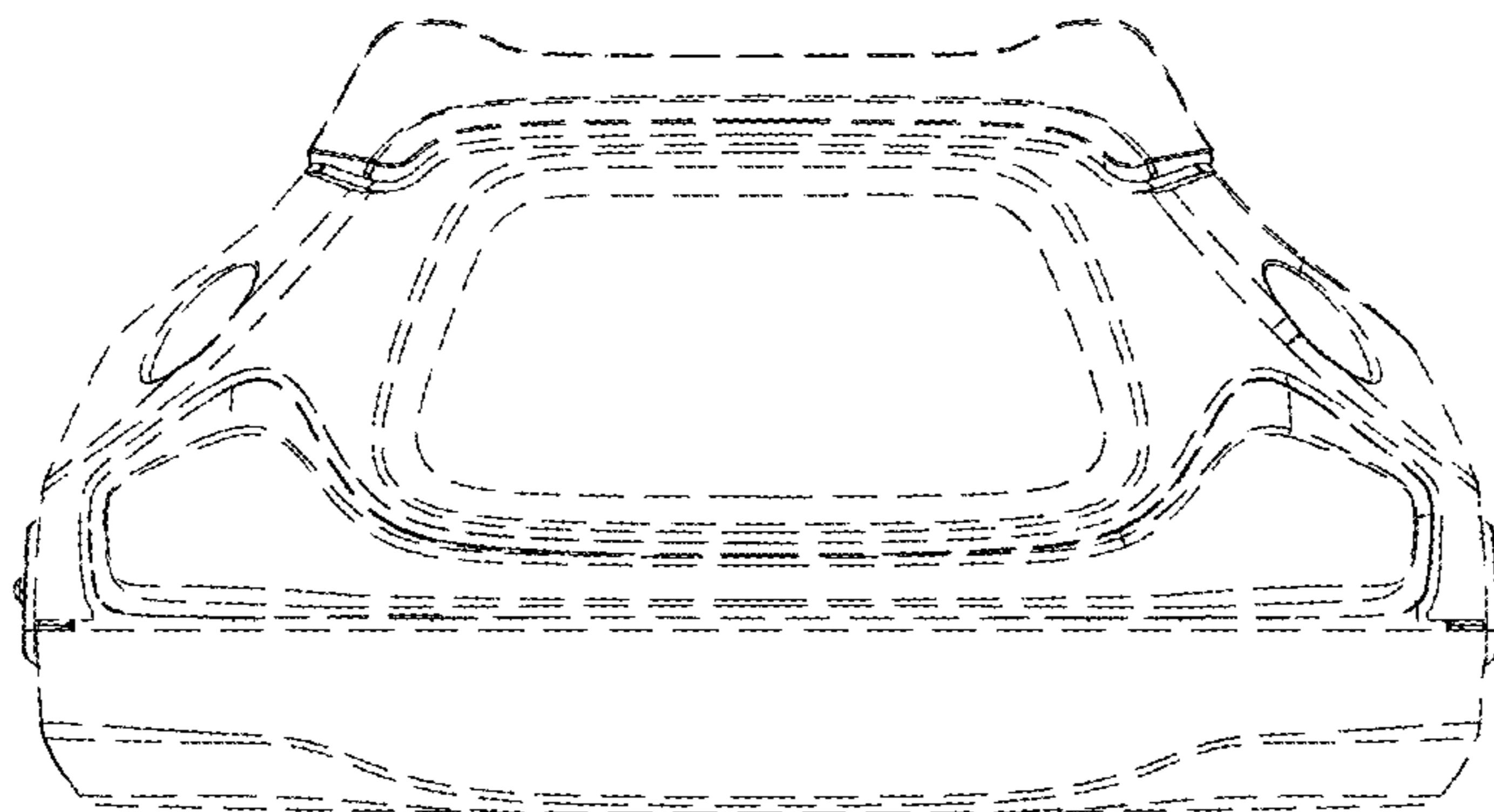

FIG. 12

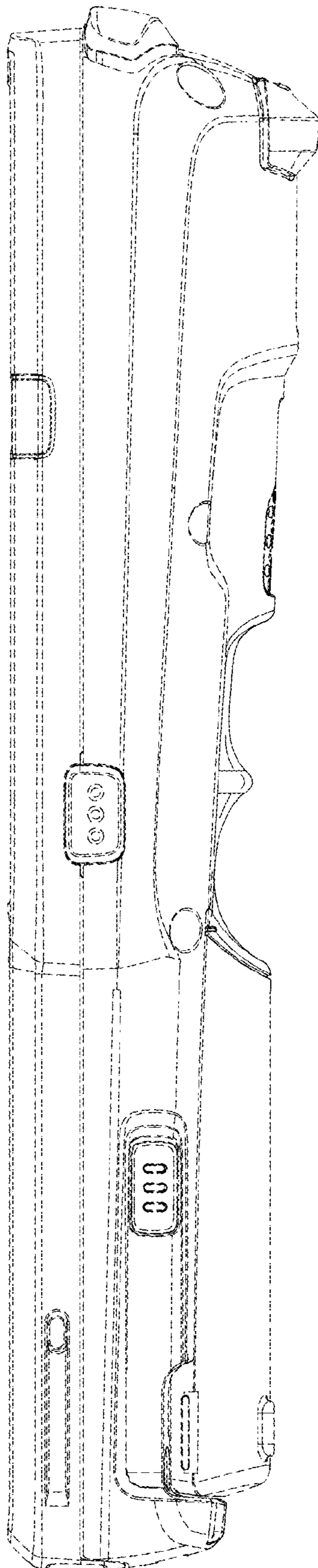

FIG. 13

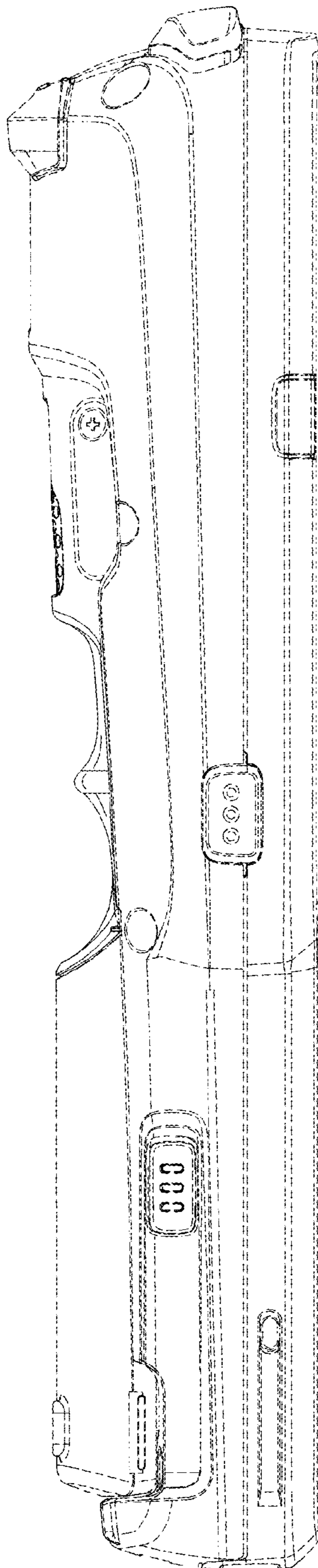

FIG. 14

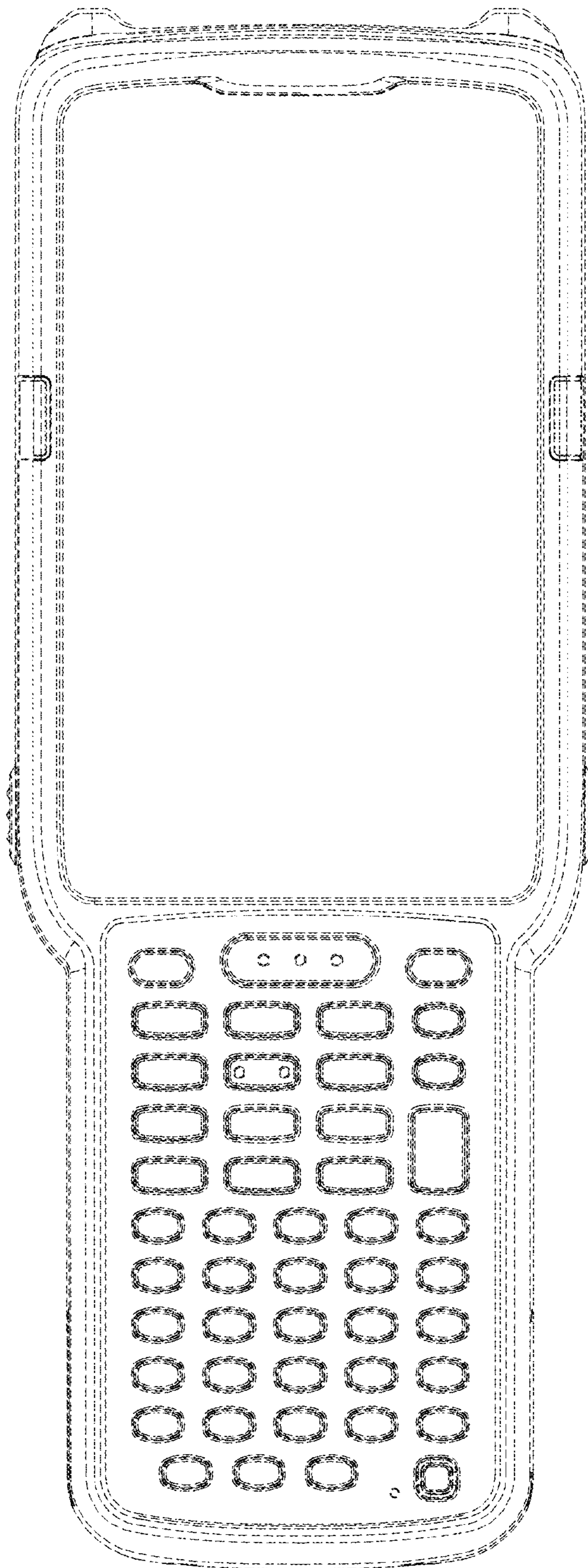

FIG. 15

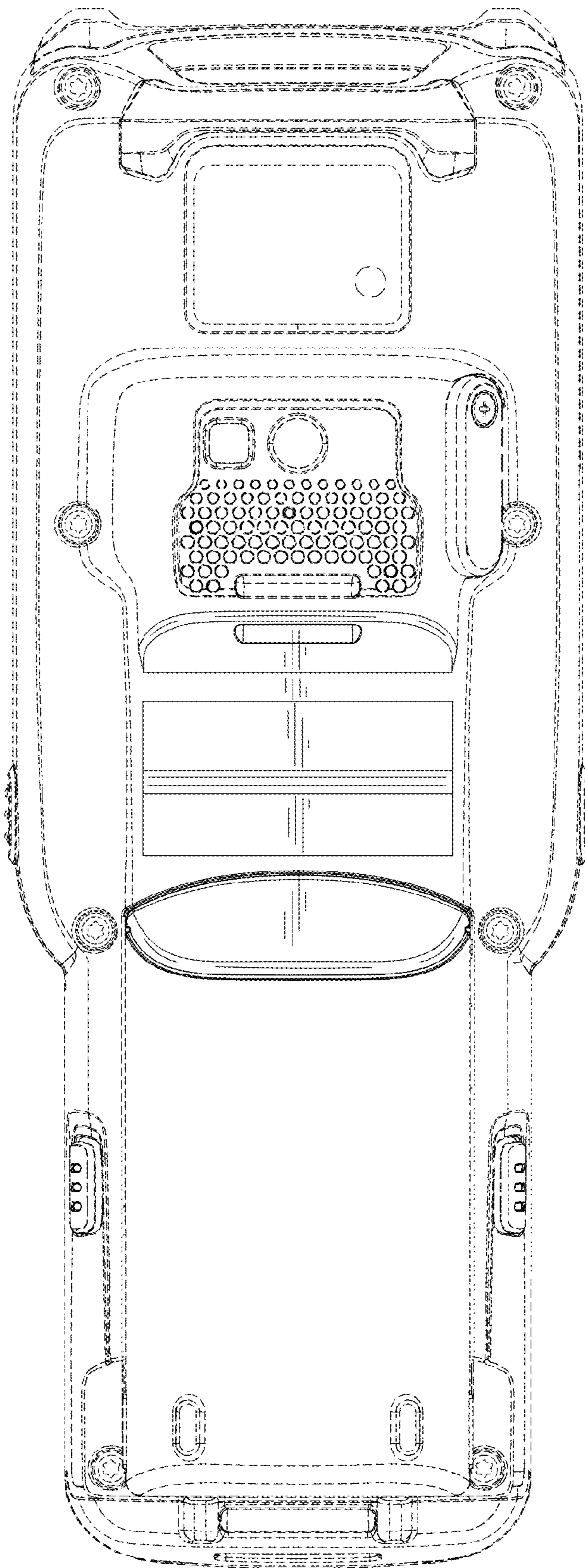

FIG. 16

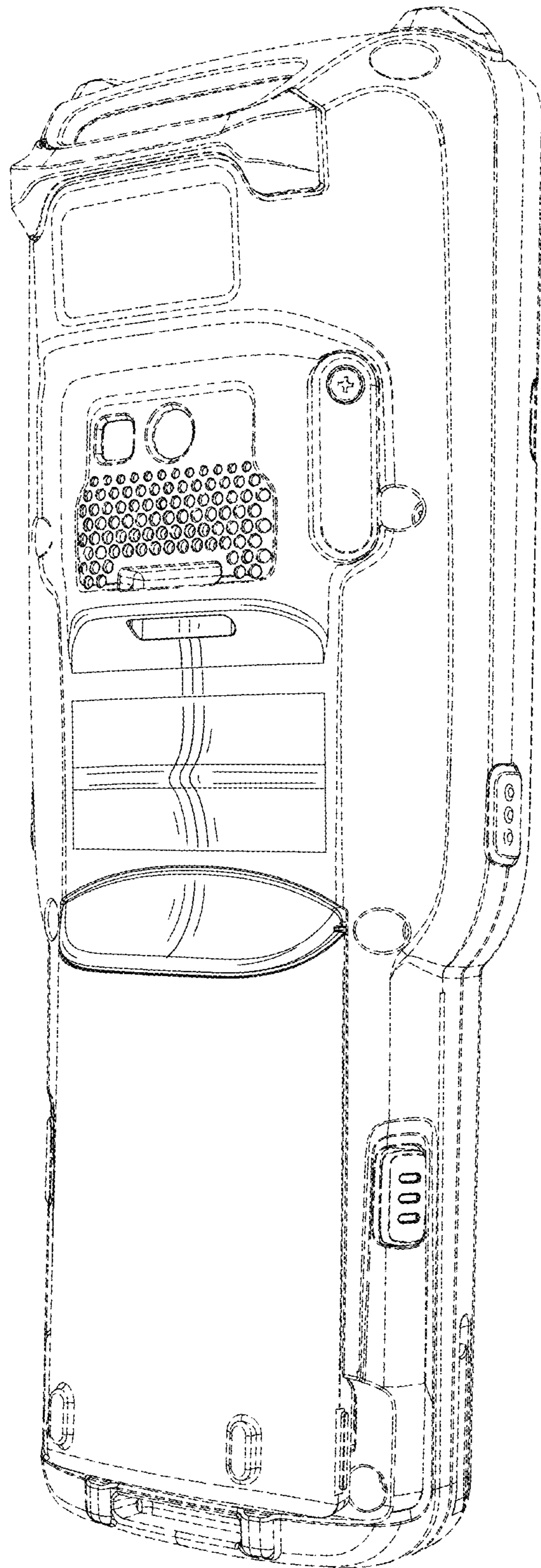

FIG. 17

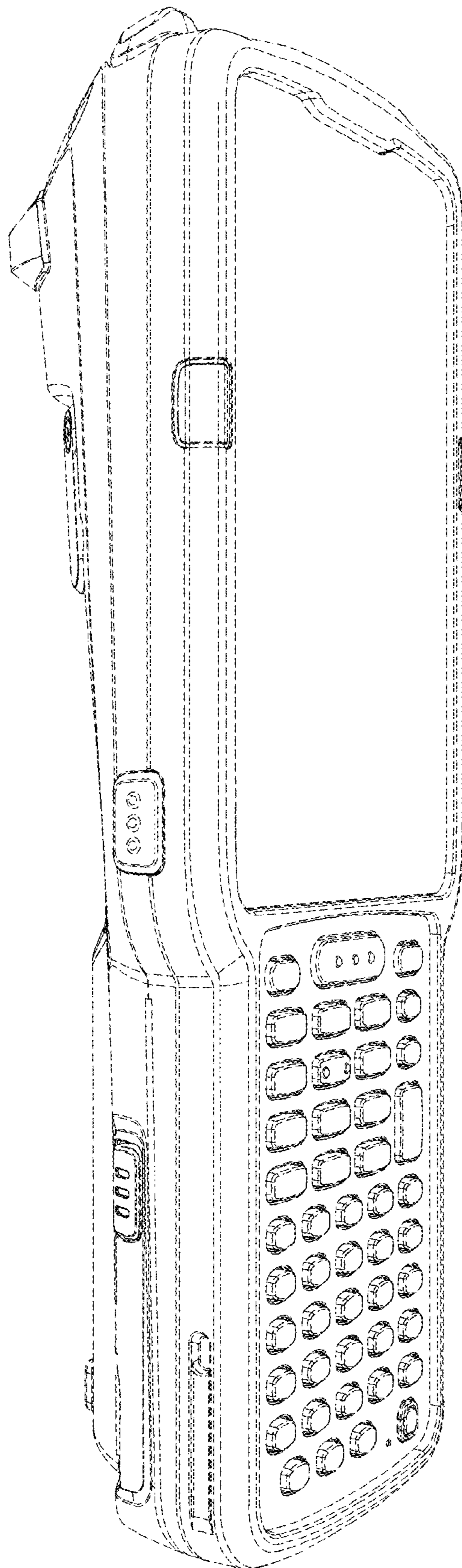

FIG. 18

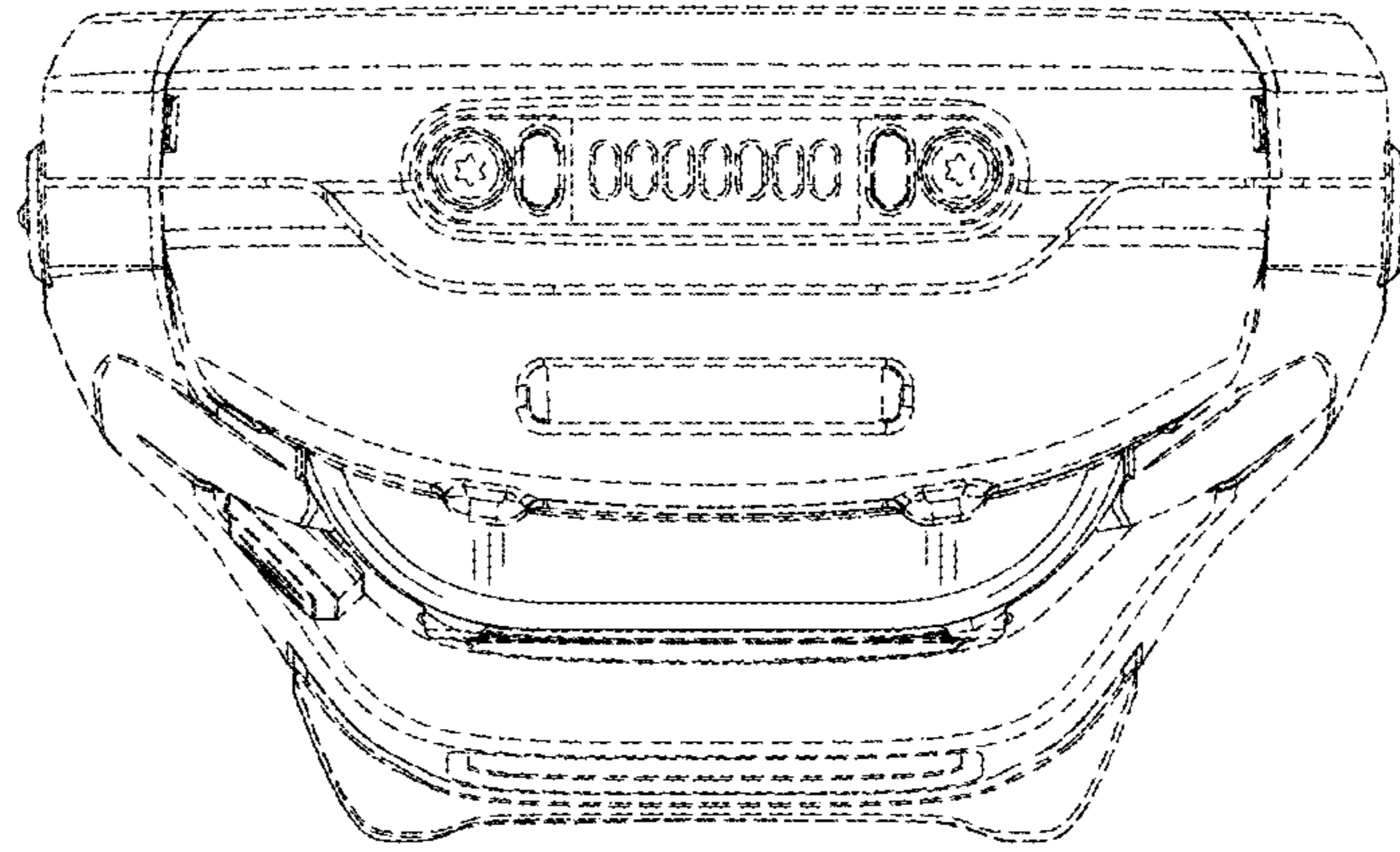

FIG. 19

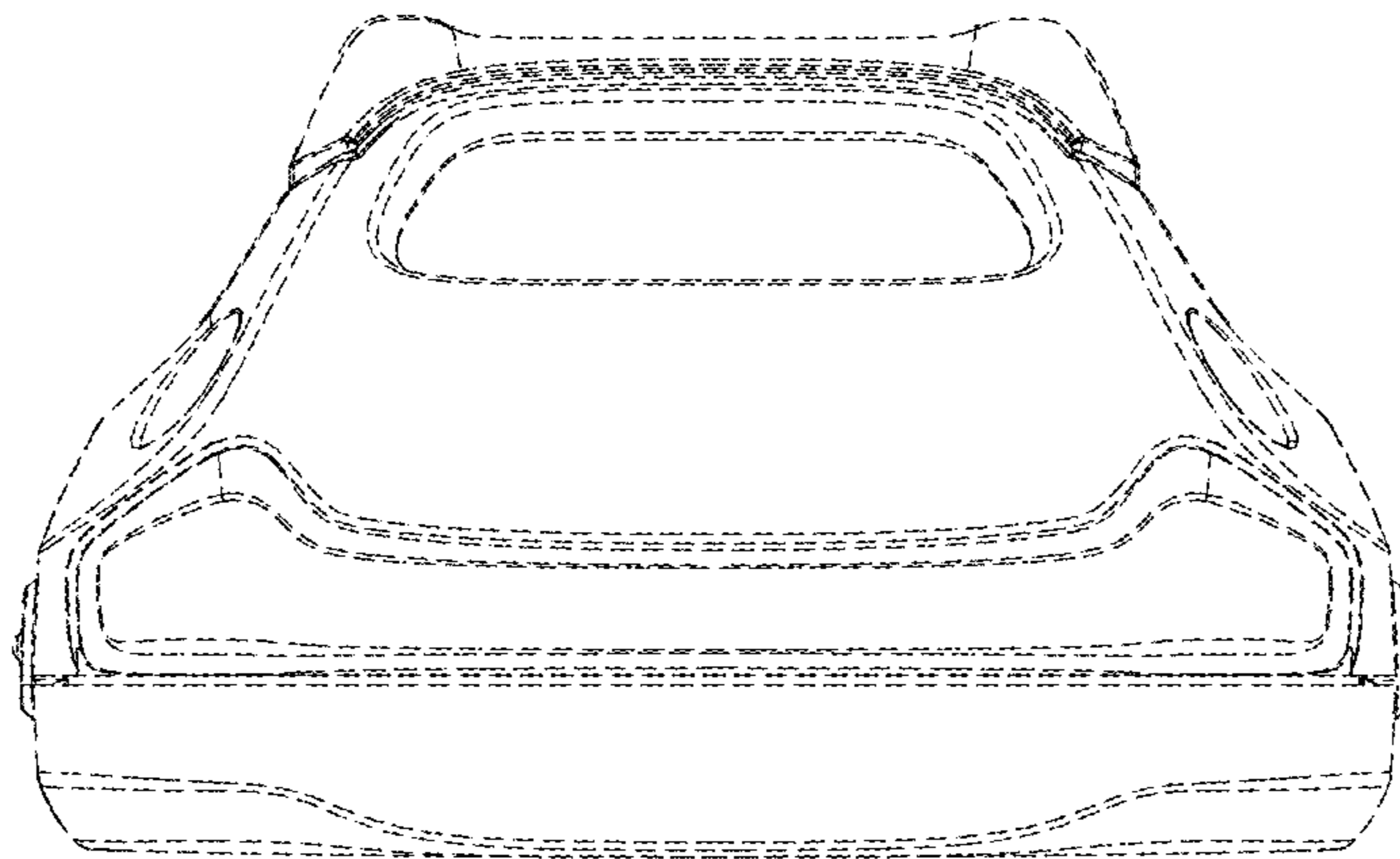

FIG. 20

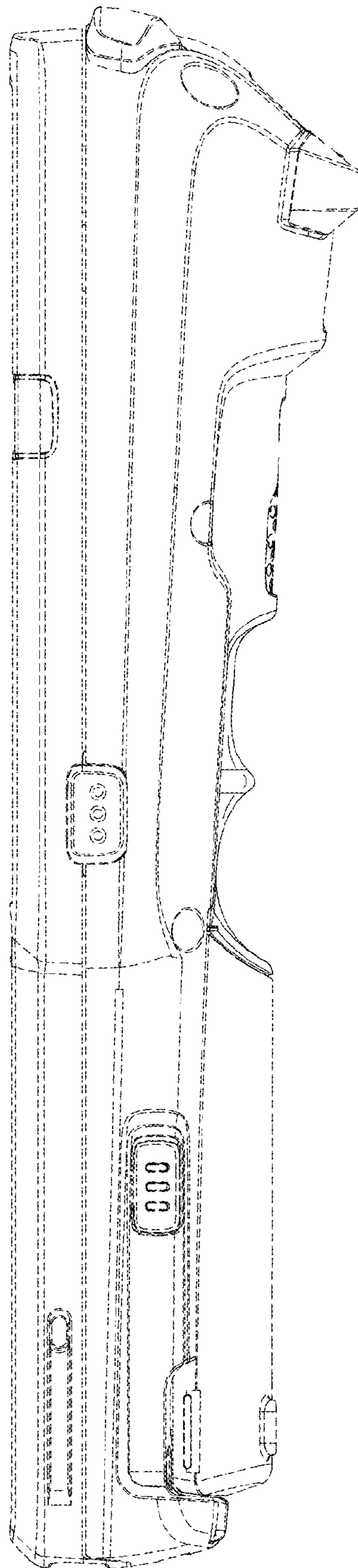

FIG. 21

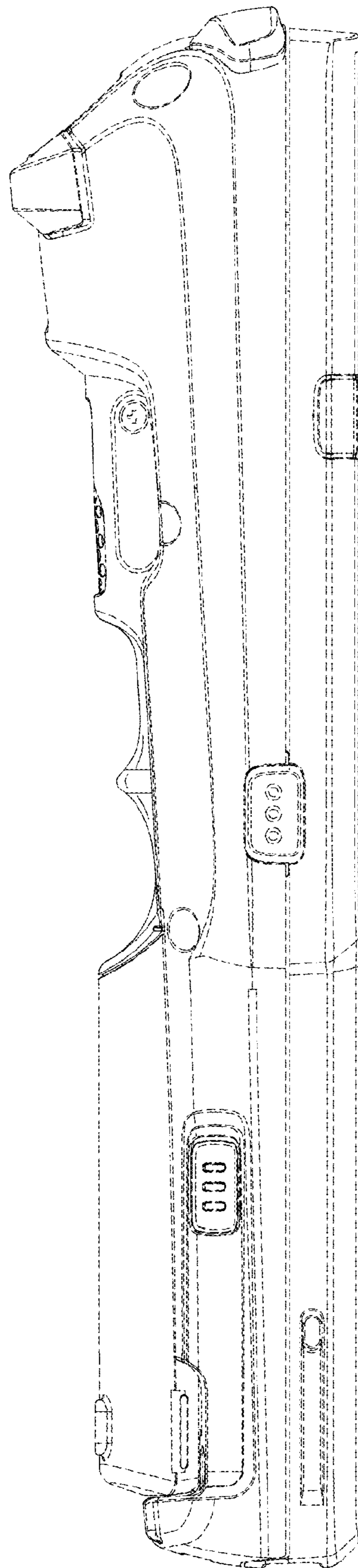

FIG. 22

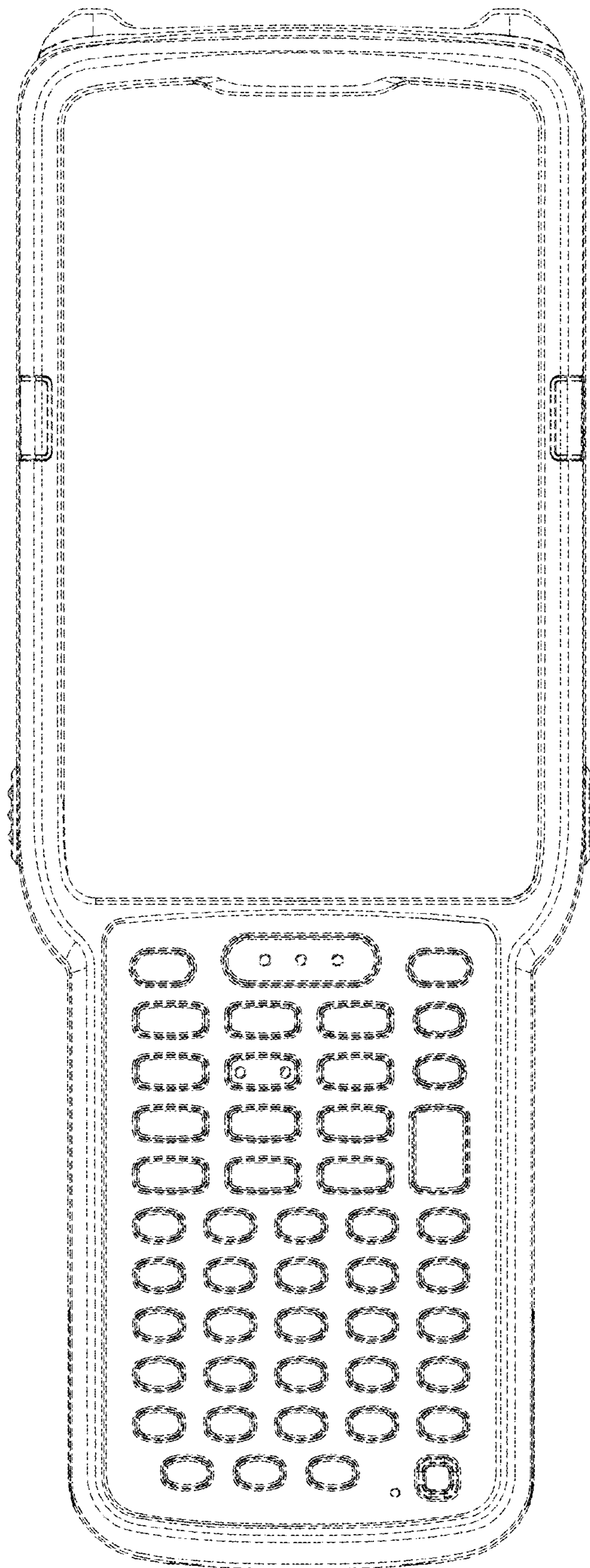

FIG. 23

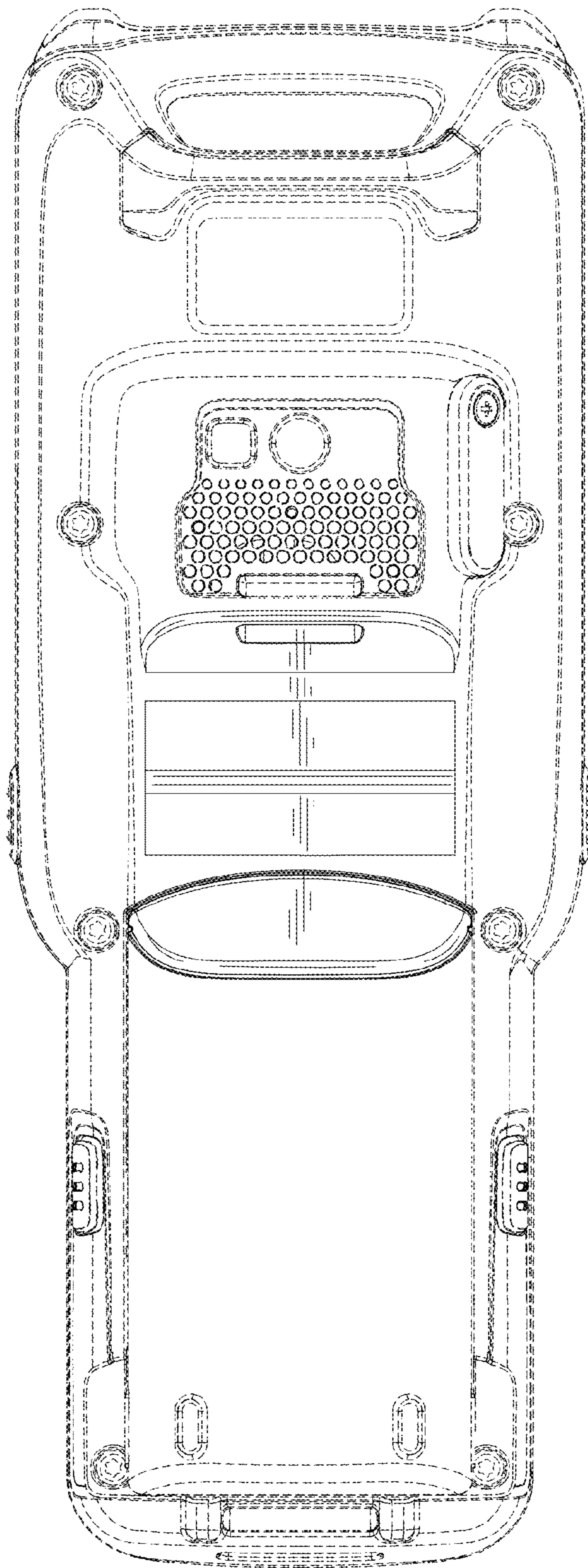

FIG. 24