



US00D883252S

(12) **United States Design Patent** (10) **Patent No.:** **US D883,252 S**  
**Tong** (45) **Date of Patent:** **\*\* May 5, 2020**

(54) **HEADPHONE**

(71) Applicant: **RAZER (ASIA-PACIFIC) PTE. LTD.**,  
Singapore (SG)

(72) Inventor: **Ien Yu Tong**, Johor (MY)

(73) Assignee: **RAZER (ASIA-PACIFIC) PTE. LTD.**,  
Singapore (SG)

(\*\*) Term: **15 Years**

(21) Appl. No.: **29/660,318**

(22) Filed: **Aug. 20, 2018**

**Related U.S. Application Data**

(63) Continuation of application No. 29/657,992, filed on  
Jul. 26, 2018, now Pat. No. Des. 873,792.

(51) **LOC (12) Cl.** ..... **14-01**

(52) **U.S. Cl.**  
USPC ..... **D14/205**

(58) **Field of Classification Search**  
USPC ..... D14/206, 226, 205; 181/129, 130, 135;  
379/430, 431; 381/380, 381, 183, 364;  
455/90.3, 575.1, 569.1; D24/106  
CPC ..... H04R 25/00; H04R 25/02; H04R 1/1016;  
H04R 1/1066; H04R 5/033; H04R  
5/0335; H04R 1/033; H04R 1/10; H04R  
1/1041; H04R 1/105; H04R 1/1091;  
H04R 1/1058; H04R 1/1075; H04R 19/04  
See application file for complete search history.

(56) **References Cited**

**U.S. PATENT DOCUMENTS**

- 2,566,313 A \* 9/1951 Cates ..... H04R 25/55  
181/22
- 3,781,492 A \* 12/1973 Cragg ..... H04R 1/08  
379/430
- 4,420,657 A \* 12/1983 Larkin ..... H04M 1/05  
181/129
- D318,669 S \* 7/1991 Nakayama ..... D14/205

- D331,057 S \* 11/1992 Isonaga ..... D14/205
- D331,408 S \* 12/1992 Ellermeier ..... D14/205
- D337,587 S \* 7/1993 Nakayama ..... D14/205
- D350,354 S \* 9/1994 Nakamura ..... D14/205
- D351,597 S \* 10/1994 Nakamura ..... D14/205
- D361,066 S \* 8/1995 Langhorn ..... D14/142
- 5,457,751 A \* 10/1995 Such ..... H04M 1/05  
348/115
- D368,716 S \* 4/1996 Shudo ..... D14/205
- D371,558 S \* 7/1996 Yoshizawa ..... D14/205
- D403,681 S \* 1/1999 Lam ..... D14/206
- D404,734 S \* 1/1999 Andrea ..... D14/206

(Continued)

**FOREIGN PATENT DOCUMENTS**

- EM 003255744-0001 \* 6/2016
- EM 006083879-0001 \* 1/2019

*Primary Examiner* — Paula Allen Greene

(74) *Attorney, Agent, or Firm* — Polsineli PC

(57) **CLAIM**

I claim the ornamental design for a headphone, as shown and described.

**DESCRIPTION**

FIG. 1 is a perspective view of an embodiment of a headphone, showing my new design;  
 FIG. 2 is a front elevational view thereof;  
 FIG. 3 is a rear elevational view thereof;  
 FIG. 4 is a left side elevational view thereof;  
 FIG. 5 is a right side elevational view thereof;  
 FIG. 6 is a top plan view thereof; and,  
 FIG. 7 is a bottom plan view thereof.  
 Broken lines immediately adjacent the surface shading represents the bounds of the claimed design while all other broken lines are directed to environment and are for illustrative purposes only; the broken lines form no part of the claimed design.

**1 Claim, 7 Drawing Sheets**

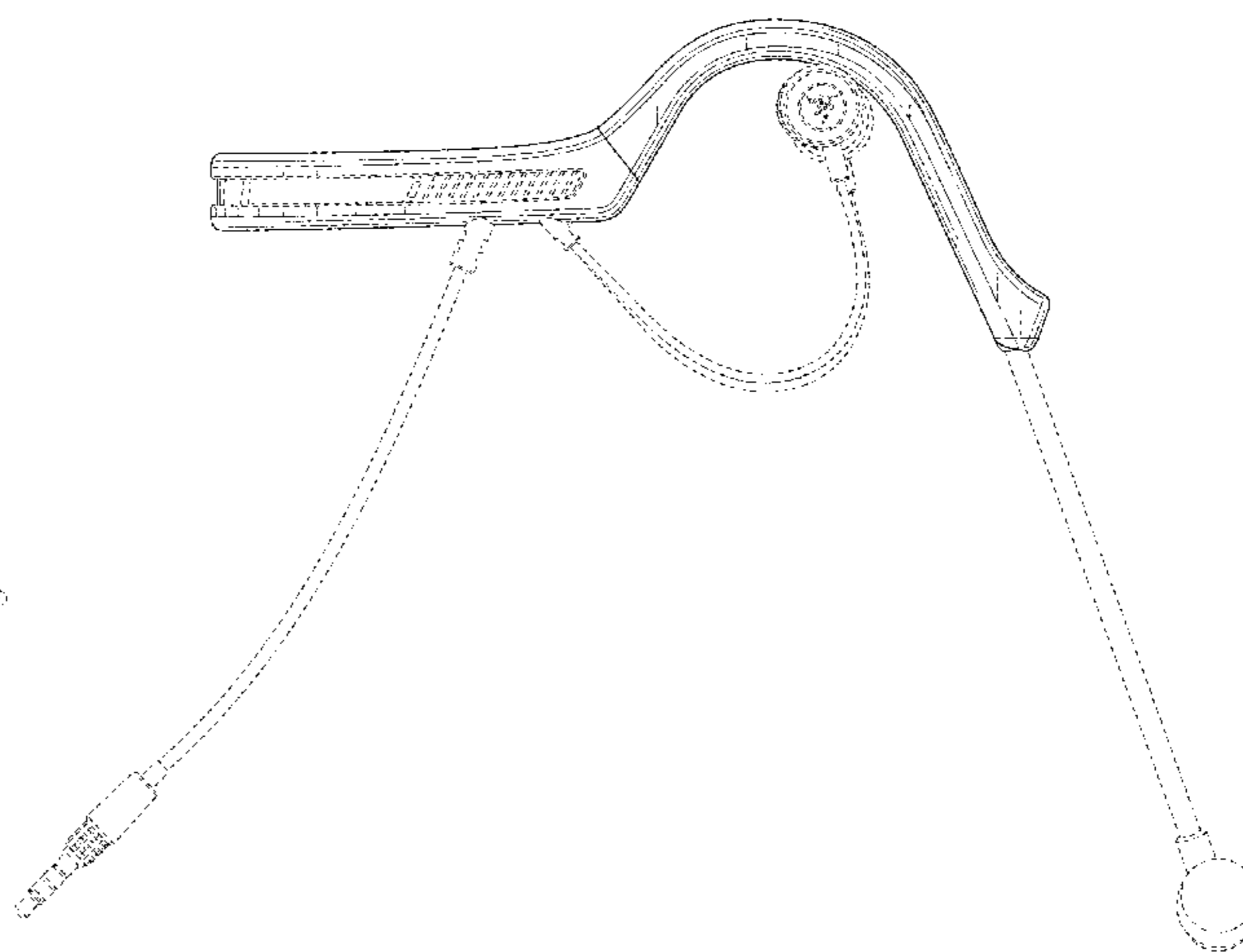
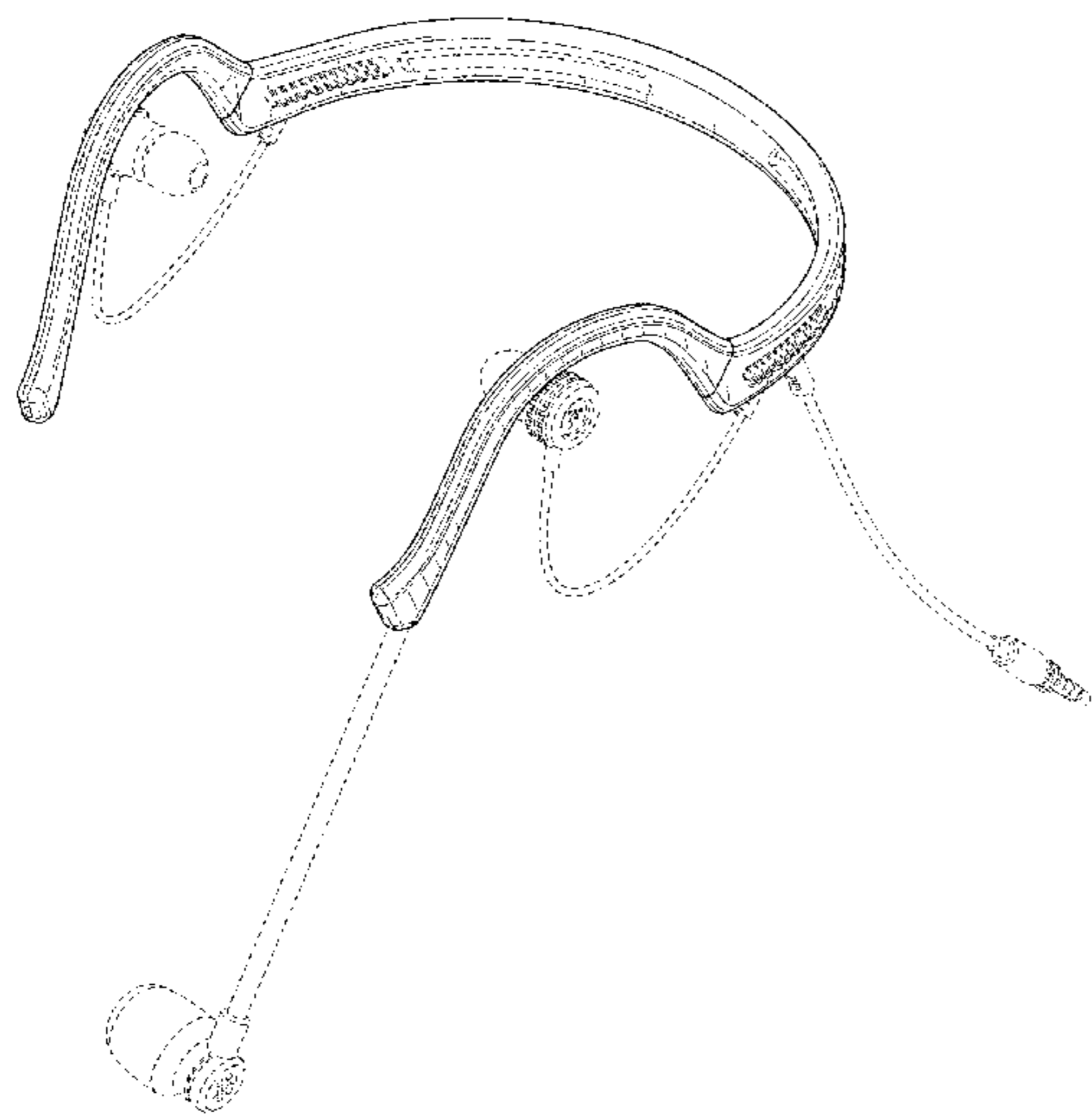

(56)

References Cited

U.S. PATENT DOCUMENTS

D420,007 S \* 2/2000 Marshall ..... D14/206  
 D426,880 S \* 6/2000 Leight ..... D14/223  
 6,097,827 A \* 8/2000 Yang ..... H04R 1/1066  
 381/375  
 6,123,168 A \* 9/2000 Berg ..... F16C 11/12  
 128/866  
 6,138,790 A \* 10/2000 Leight ..... A61F 11/12  
 128/857  
 6,178,251 B1 \* 1/2001 Luchs ..... H04R 1/083  
 381/362  
 6,233,345 B1 \* 5/2001 Urwyler ..... H04R 1/1033  
 351/123  
 D458,245 S \* 6/2002 Masuda ..... D14/192  
 6,456,721 B1 \* 9/2002 Fukuda ..... H04R 1/1066  
 381/151  
 D471,176 S \* 3/2003 Suzuki ..... D14/205  
 6,560,346 B2 \* 5/2003 Ohta ..... H04R 1/083  
 381/370  
 6,603,863 B1 \* 8/2003 Nagayoshi ..... H04R 1/1066  
 381/370  
 6,625,293 B1 \* 9/2003 Nageno ..... H04R 1/08  
 181/20  
 6,690,808 B2 \* 2/2004 Urwyler ..... H04R 1/1033  
 381/327  
 D502,463 S \* 3/2005 Bhakta ..... D14/205  
 6,920,228 B2 \* 7/2005 Redmer ..... H04R 1/1058  
 381/370  
 D533,539 S \* 12/2006 Mah ..... D14/205  
 D550,202 S \* 9/2007 Meier ..... D14/206  
 D560,206 S \* 1/2008 Hermansen ..... D14/206  
 D565,557 S \* 4/2008 Kaneda ..... D14/206  
 D575,268 S \* 8/2008 Christopher ..... D14/205  
 D578,508 S \* 10/2008 Wang ..... D14/206  
 D579,442 S \* 10/2008 Kim ..... D14/205  
 D587,678 S \* 3/2009 Yuyama ..... D14/205  
 D588,099 S \* 3/2009 Yuyama ..... D14/205  
 D590,810 S \* 4/2009 Komiyama ..... D14/205  
 D593,067 S \* 5/2009 Millora ..... D14/205  
 D594,442 S \* 6/2009 Chon ..... D14/205  
 D599,777 S \* 9/2009 Yuyama ..... D14/205  
 D617,308 S \* 6/2010 Nousiainen ..... D14/205  
 D645,444 S \* 9/2011 Quek ..... D14/205

D653,234 S \* 1/2012 Lee ..... D14/205  
 D669,881 S \* 10/2012 Clements ..... D14/205  
 D678,857 S \* 3/2013 Feng ..... D14/205  
 D678,858 S \* 3/2013 Feng ..... D14/205  
 8,411,893 B2 \* 4/2013 Ito ..... H04R 1/1066  
 181/135  
 8,433,082 B2 \* 4/2013 Abolfathi ..... H04R 25/606  
 381/151  
 D695,264 S \* 12/2013 Chee ..... D14/205  
 D703,634 S \* 4/2014 Han ..... H04R 1/1016  
 D14/205  
 D706,745 S \* 6/2014 Nakagawa ..... H04R 1/1066  
 D14/205  
 D707,199 S \* 6/2014 Cepress ..... H04R 1/10  
 D14/205  
 D716,759 S \* 11/2014 Ha ..... D14/205  
 D731,999 S \* 6/2015 Cepress ..... D14/205  
 D756,958 S \* 5/2016 Lee ..... D14/205  
 D771,011 S \* 11/2016 Ott ..... H04R 1/1016  
 D14/205  
 D772,196 S \* 11/2016 Choi ..... D14/205  
 D774,017 S \* 12/2016 Ahn ..... D14/205  
 D793,358 S \* 8/2017 Lee ..... D14/205  
 D817,302 S \* 5/2018 Birath ..... D14/205  
 D823,280 S \* 7/2018 Guilfoyle ..... D14/206  
 D842,839 S \* 3/2019 Klein ..... D14/206  
 D843,347 S \* 3/2019 Bryant ..... D14/206  
 D851,061 S \* 6/2019 Zeng ..... D14/205  
 D851,625 S \* 6/2019 Mackiewicz ..... D14/205  
 D853,351 S \* 7/2019 Ott ..... D14/205  
 D853,987 S \* 7/2019 Kelley ..... D14/205  
 D854,512 S \* 7/2019 Huang ..... D14/205  
 2002/0048385 A1 \* 4/2002 Rosenberg ..... H04M 1/05  
 381/374  
 2010/0111349 A1 \* 5/2010 Devlas ..... H04R 1/1033  
 381/380  
 2011/0058696 A1 \* 3/2011 Armstrong ..... H04R 1/1066  
 381/309  
 2011/0170702 A1 \* 7/2011 Bays ..... H04R 5/0335  
 381/74  
 2014/0185837 A1 \* 7/2014 Kunimoto ..... H04R 1/1075  
 381/151  
 2017/0295419 A1 \* 10/2017 Poulsen ..... H04R 5/04  
 2019/0349659 A1 \* 11/2019 Ott ..... H04R 1/1066

\* cited by examiner

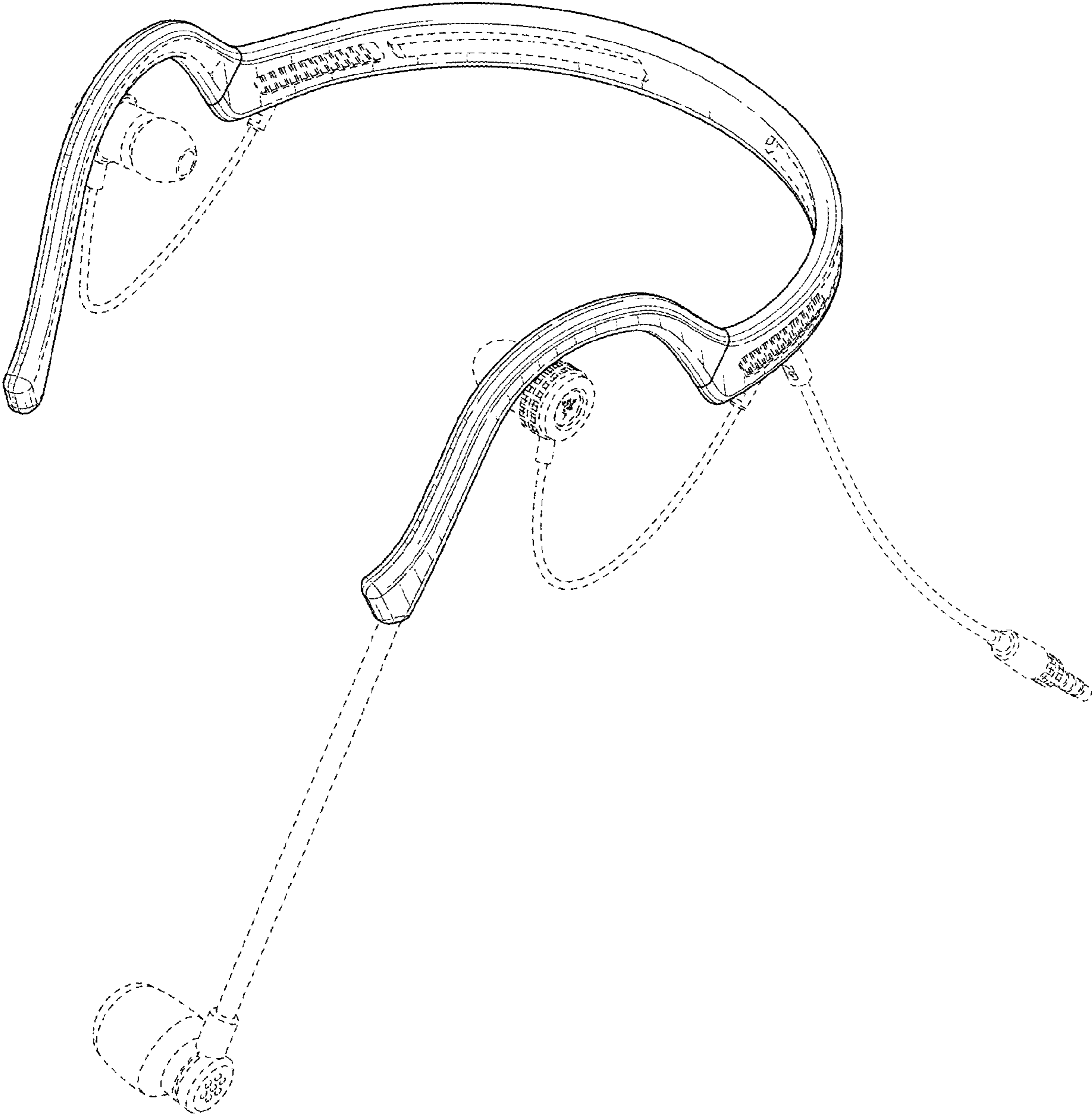

FIG. 1



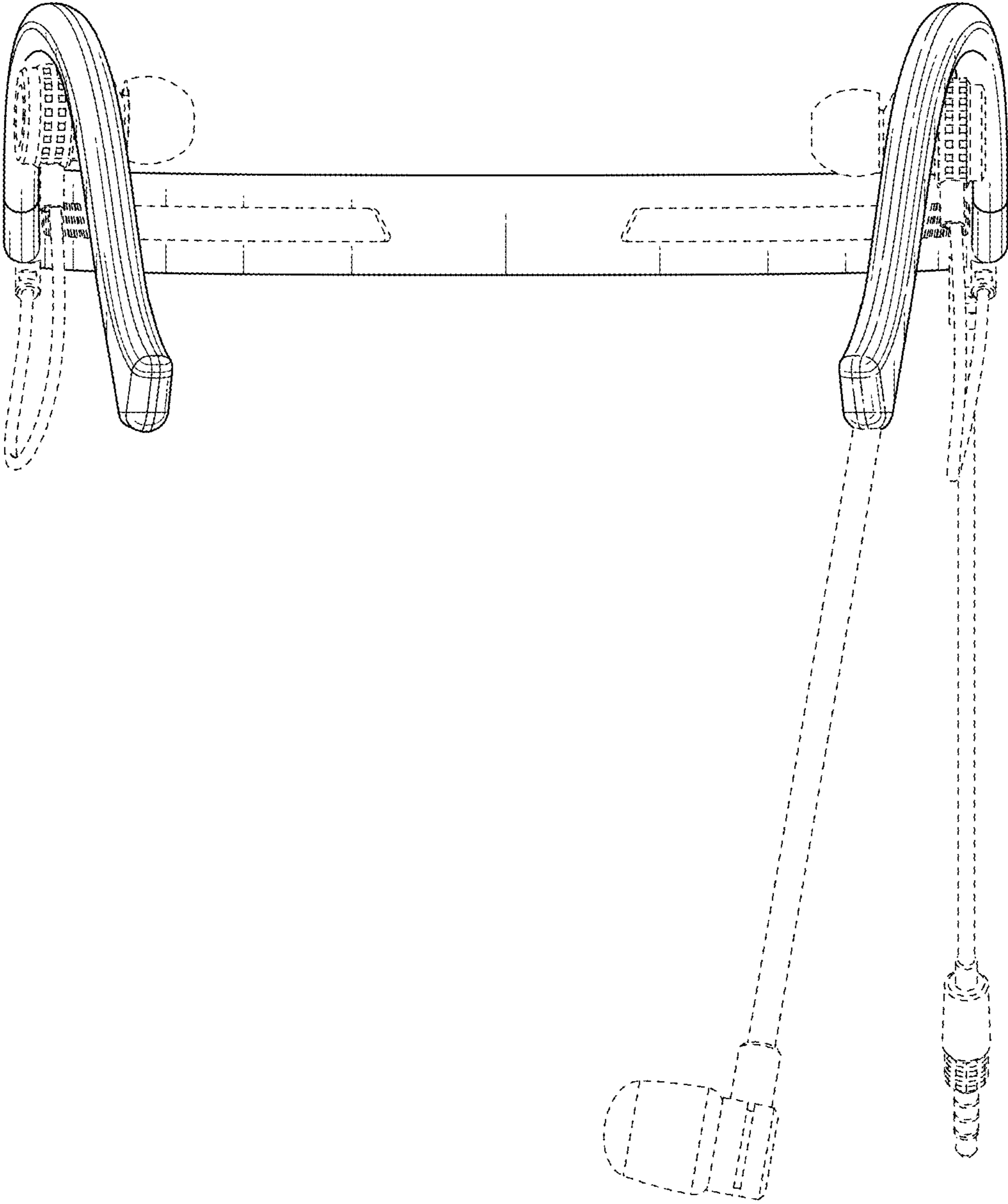

FIG. 2

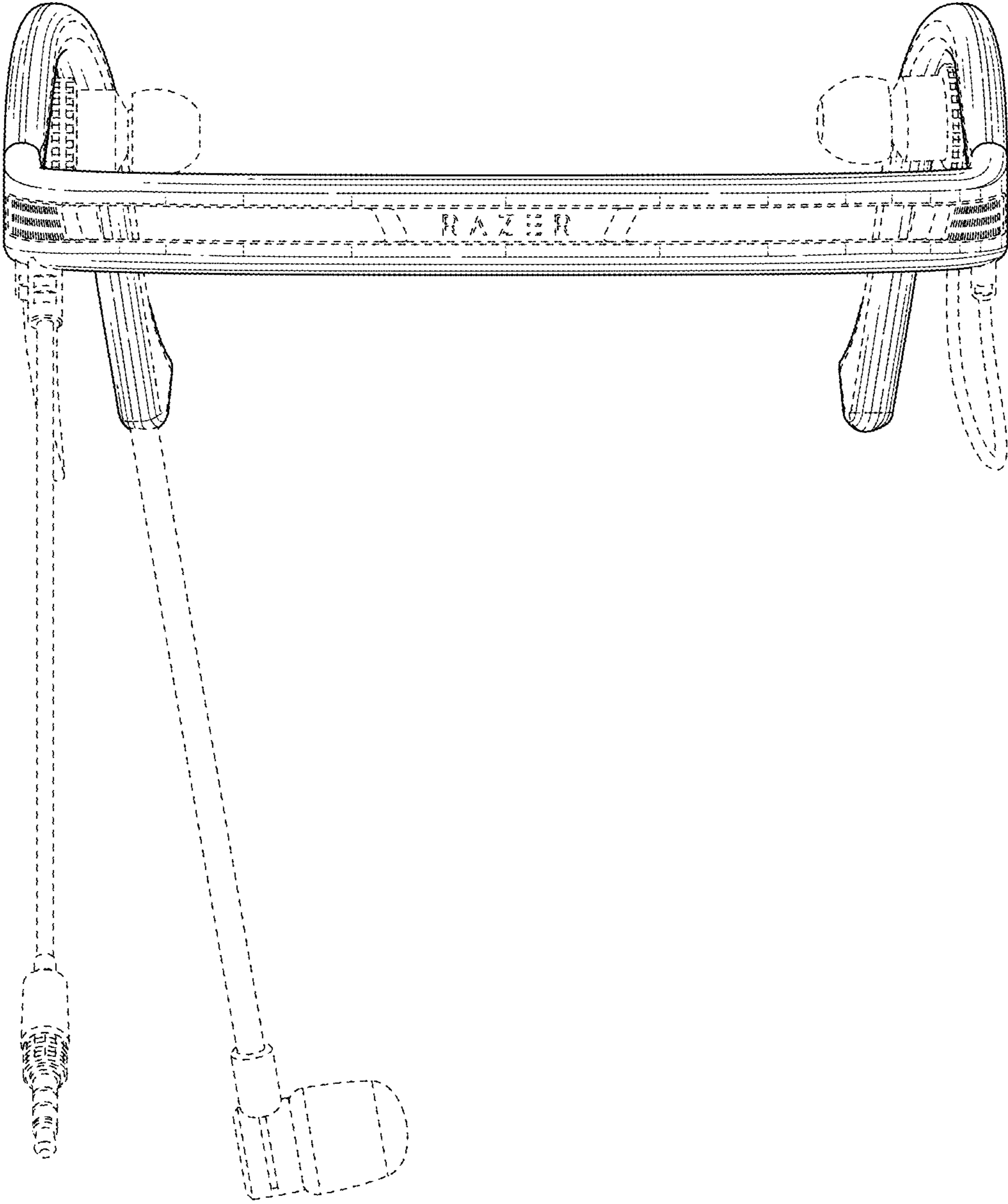

FIG. 3

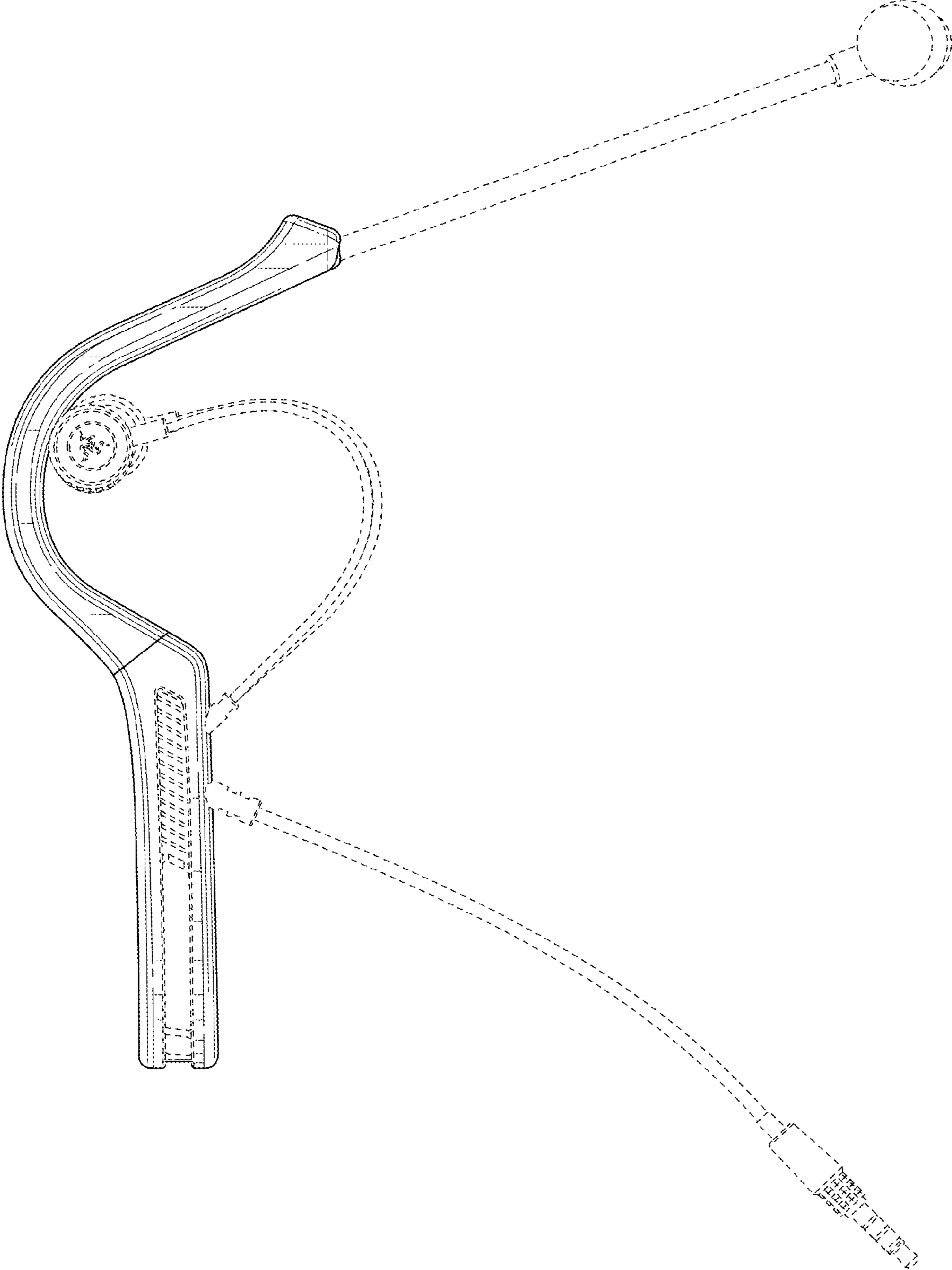

FIG. 4

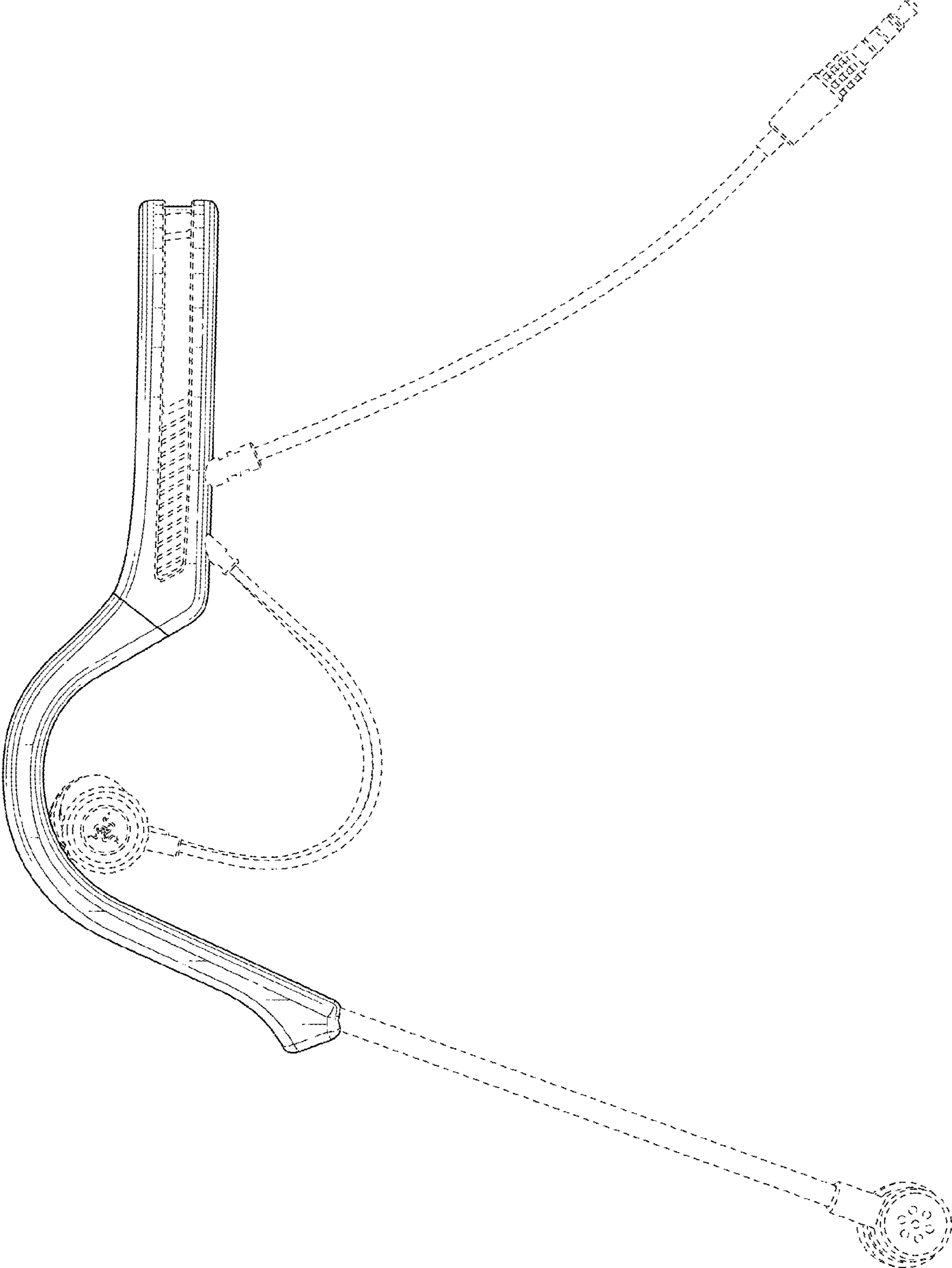

FIG. 5

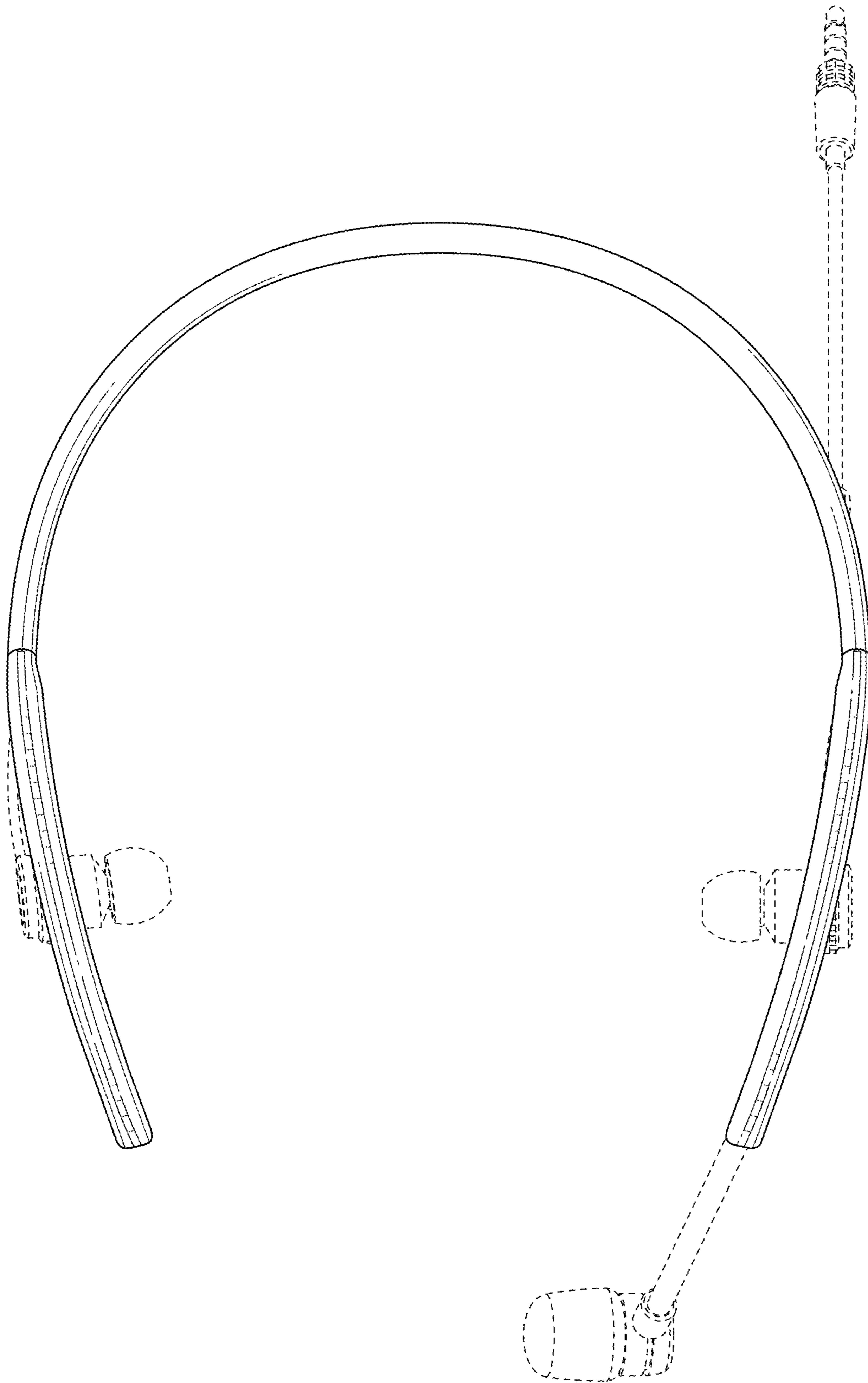

FIG. 6



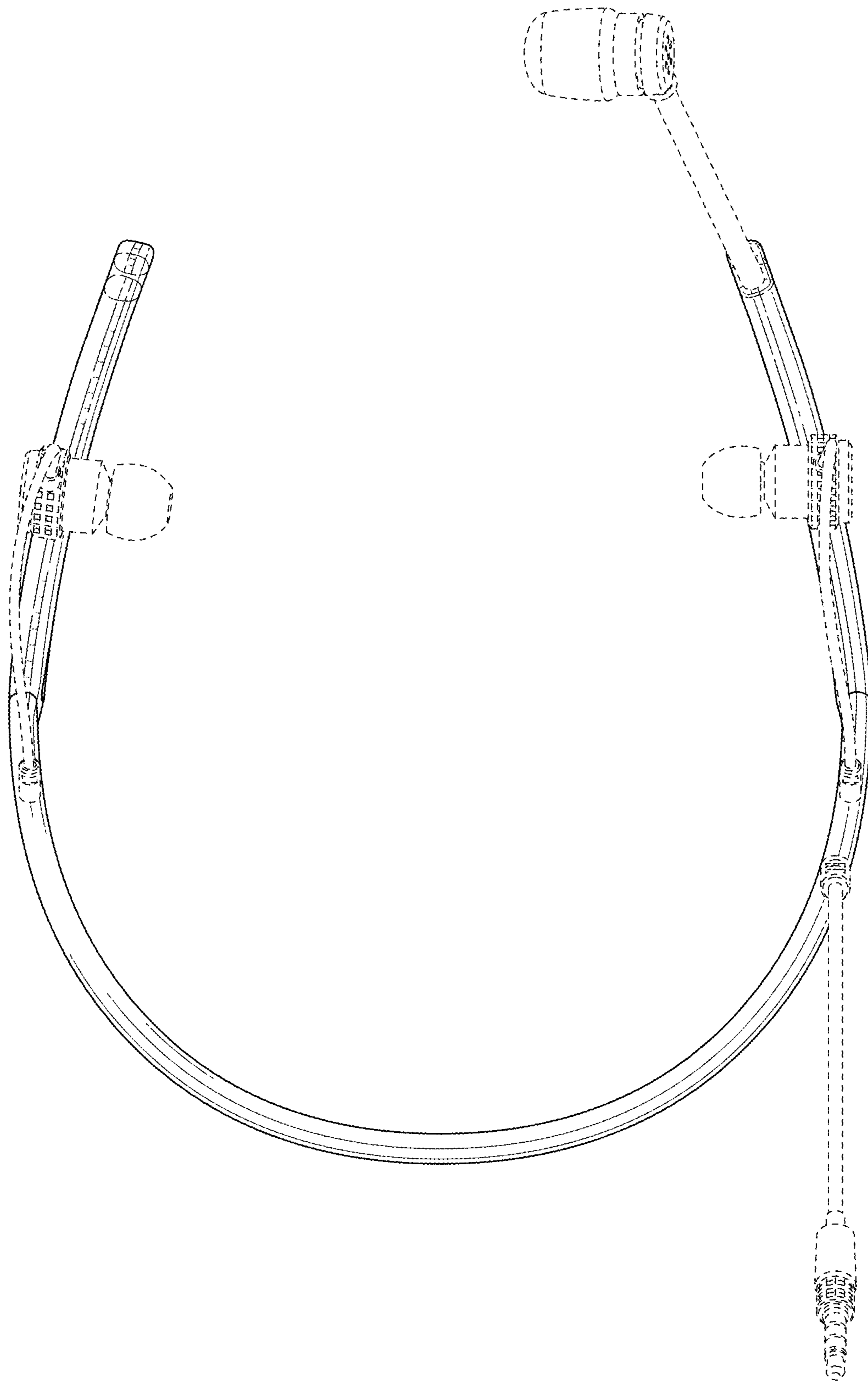

FIG. 7