



US00D883197S

(12) **United States Design Patent** (10) **Patent No.:** **US D883,197 S**  
**Doucet** (45) **Date of Patent:** **\*\* May 5, 2020**

(54) **CHARGING CASE**  
(71) Applicant: **NJOY, LLC**, Scottsdale, AZ (US)  
(72) Inventor: **Joe Doucet**, Brooklyn, NY (US)  
(73) Assignee: **NJOY, LLC**, Scottsdale, AZ (US)  
(\*\*) Term: **15 Years**  
(21) Appl. No.: **29/649,418**  
(22) Filed: **May 30, 2018**  
(51) **LOC (12) Cl.** ..... **13-02**  
(52) **U.S. Cl.**  
USPC ..... **D13/107**  
(58) **Field of Classification Search**  
USPC ..... D13/103, 107-110, 118-119, 184, 199;  
D14/251, 253, 432, 434; D27/183, 193,  
D27/194  
CPC ..... Y02E 60/10; Y02E 60/12; Y02E 60/122;  
Y02E 60/124; Y02E 60/50; H02J 7/00;  
H02J 7/0003; H02J 7/0011; H02J 7/0013;  
H02J 7/0054; H02J 7/0055; H02J 7/0057;  
H01M 10/44; H01M 10/46; H01M  
10/465; H01M 10/482; H01M 2/02;  
H01M 2/022; H01M 2/0202; H01M  
2/0207; H01M 2/0212; H01M 2/1061;  
H01M 2/1022; H01M 2/1055; H01M  
2/1066; H01M 2/105; H01M 2/20; H01M  
2/202; H01M 2/204; H01M 2/206; H01M  
2200/30; H01M 2250/30; H01M 2250/40  
See application file for complete search history.

(56) **References Cited**  
U.S. PATENT DOCUMENTS  
D642,929 S 8/2011 Mansau  
D656,094 S \* 3/2012 Wu ..... D13/108  
D683,898 S \* 6/2013 Liu ..... D13/108  
D683,899 S \* 6/2013 Liu ..... D13/108  
D688,418 S \* 8/2013 Liu ..... D13/108

D700,397 S 2/2014 Manca et al.  
D700,738 S 3/2014 Rennick et al.  
D700,739 S 3/2014 Manca et al.  
D734,250 S \* 7/2015 Rennick ..... D13/107  
D734,251 S \* 7/2015 Rennick ..... D13/107  
D736,701 S \* 8/2015 Shigeno ..... D13/108  
D770,972 S \* 11/2016 Kruglak ..... D13/107  
D773,989 S \* 12/2016 Schiff ..... D13/107  
D790,455 S 6/2017 McGarry et al.  
D807,579 S 1/2018 Wu  
D826,152 S \* 8/2018 Christiansen ..... D13/108  
D841,580 S \* 2/2019 Bao ..... D13/108  
(Continued)

**FOREIGN PATENT DOCUMENTS**

CN 3268051 D 12/2002  
CN 303241494 6/2015  
CN 303999349 1/2017  
(Continued)

*Primary Examiner* — Rosemary K Tarcza  
(74) *Attorney, Agent, or Firm* — Bookoff McAndrews,  
PLLC

(57) **CLAIM**  
The ornamental design for a charging case, as shown as  
described.

**DESCRIPTION**  
FIG. 1 is a front view of the charging case;  
FIG. 2 is a back view thereof;  
FIG. 3 is a left side view thereof;  
FIG. 4 is a right side view thereof;  
FIG. 5 is a top view thereof;  
FIG. 6 is a bottom view thereof;  
FIG. 7 is a first perspective view thereof; and,  
FIG. 8 is a second perspective view thereof.  
The broken lines shown in the drawings are included for the  
purpose of illustrating portions of the charging case that  
form no part of the claimed design.

**1 Claim, 6 Drawing Sheets**

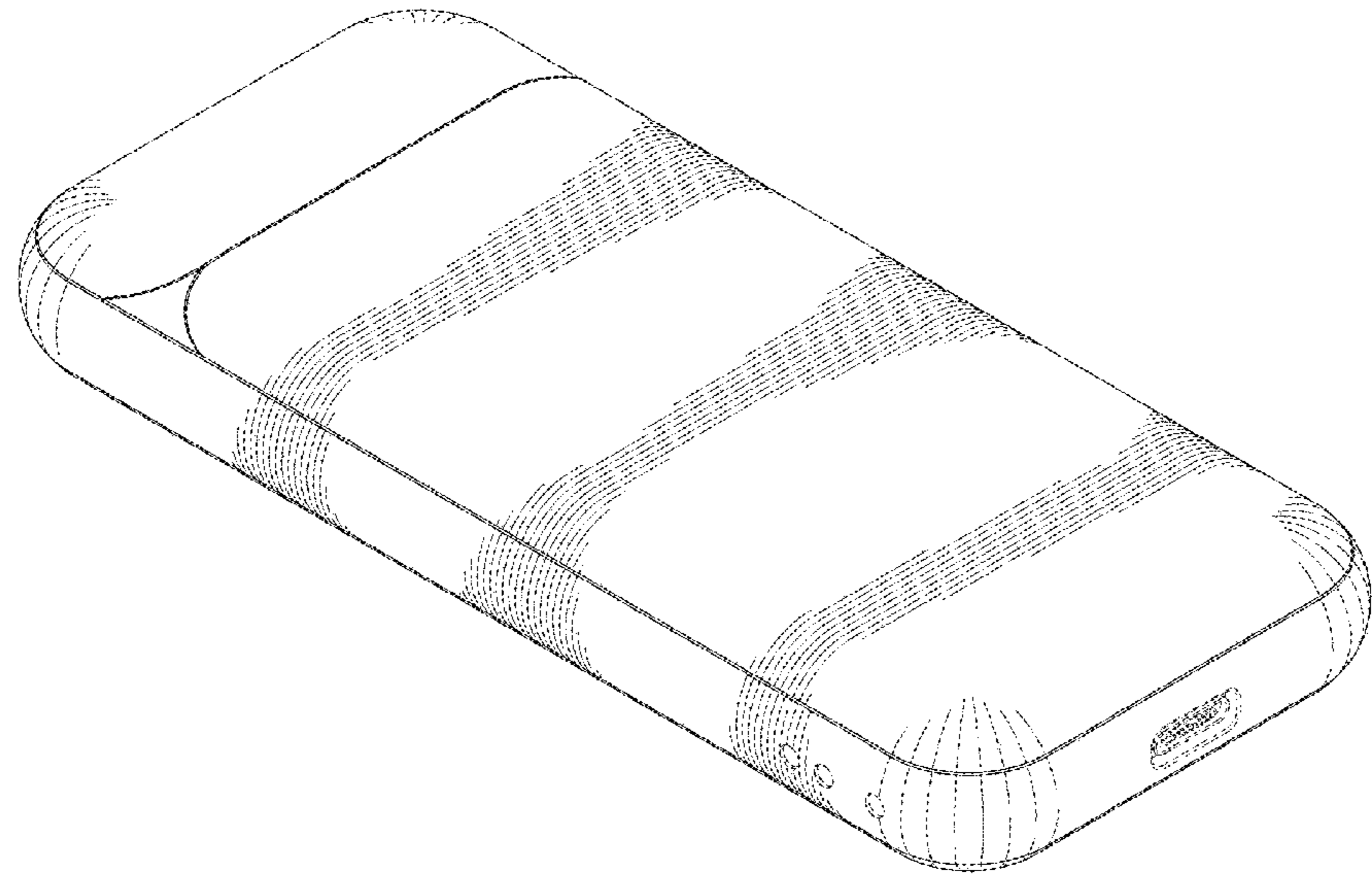

(56)

**References Cited**

U.S. PATENT DOCUMENTS

D841,581 S \* 2/2019 Bonahoom ..... D13/108

FOREIGN PATENT DOCUMENTS

CN	304680037	6/2018
EM	002531533-0001	9/2014
EM	004354835-0001	9/2017
EM	004354835-0002	9/2017
EM	005948544-0001	1/2019

\* cited by examiner

FIG. 1

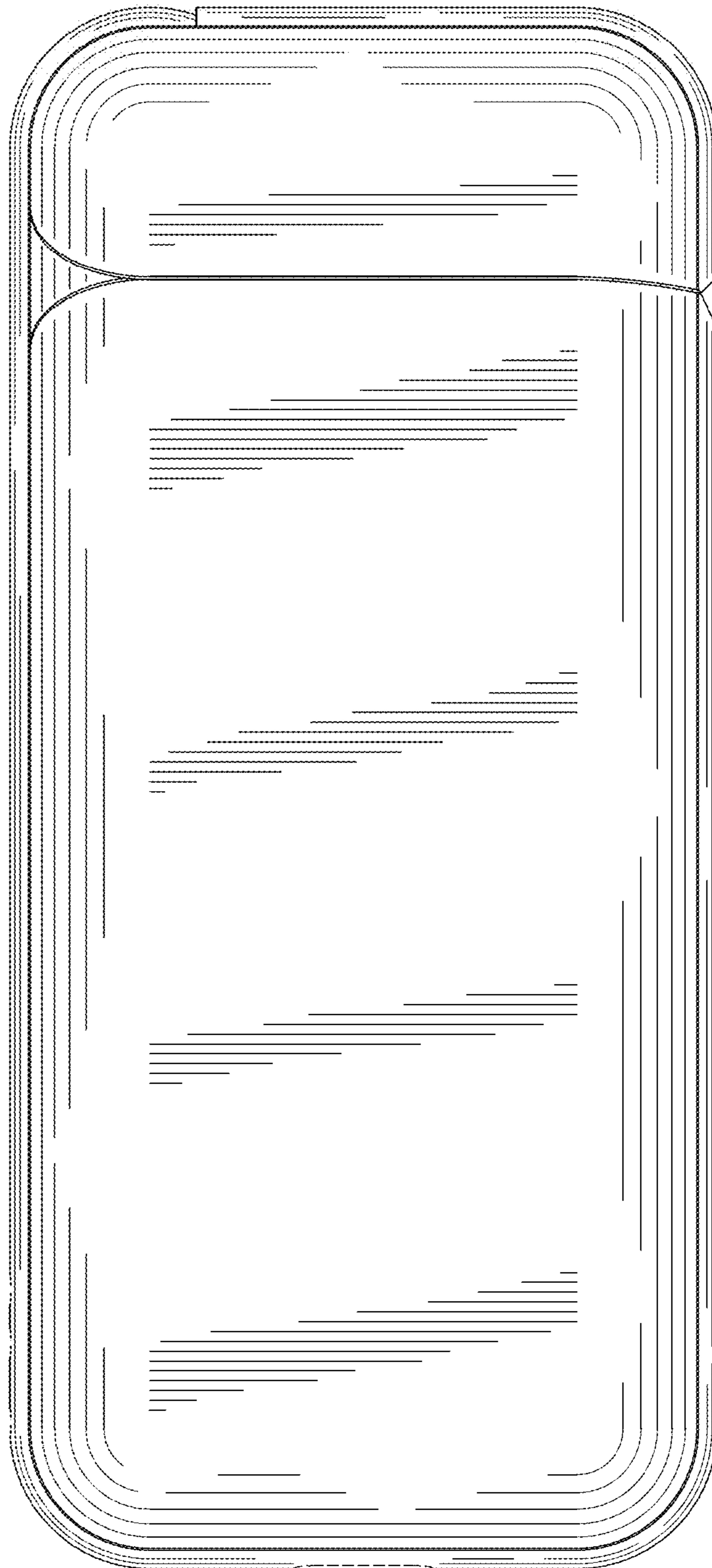

FIG. 2

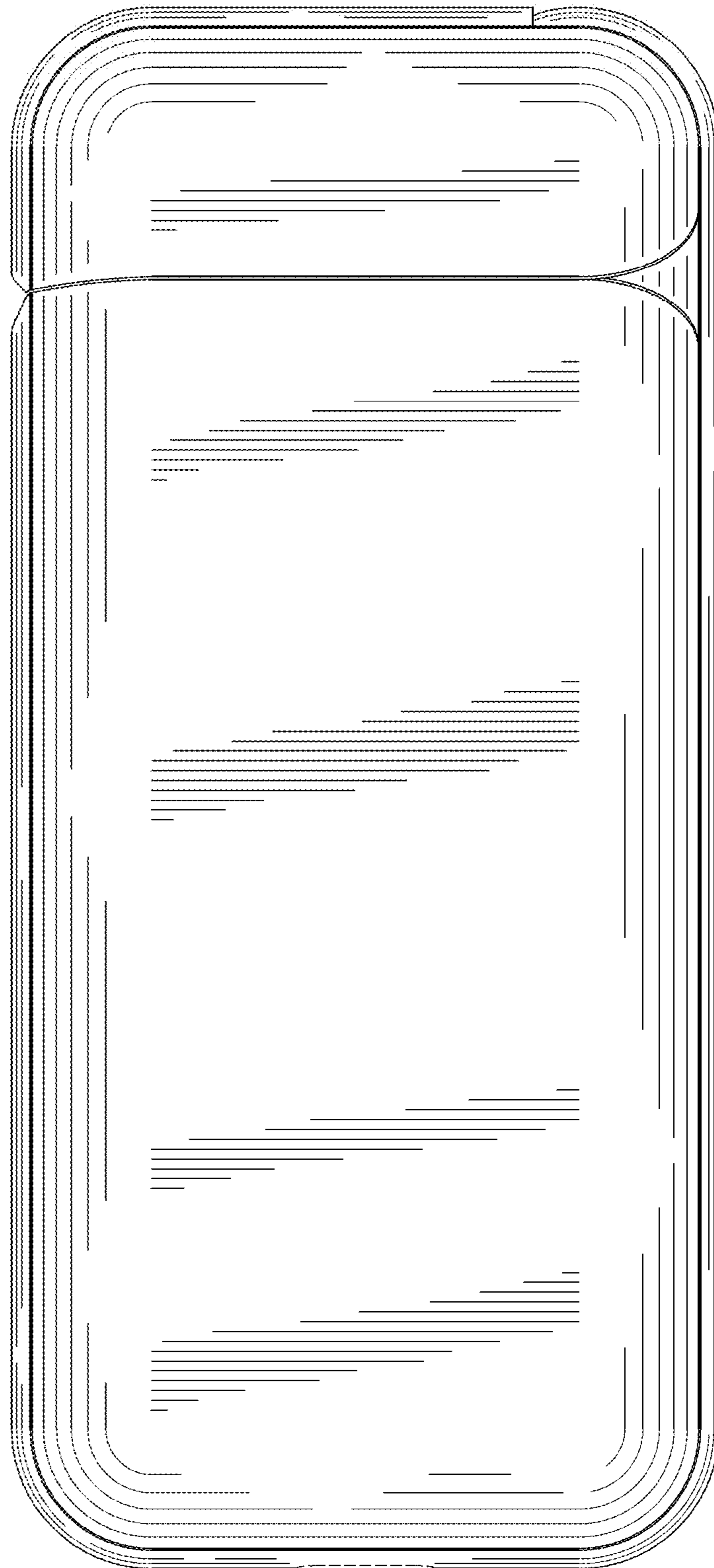

FIG. 3

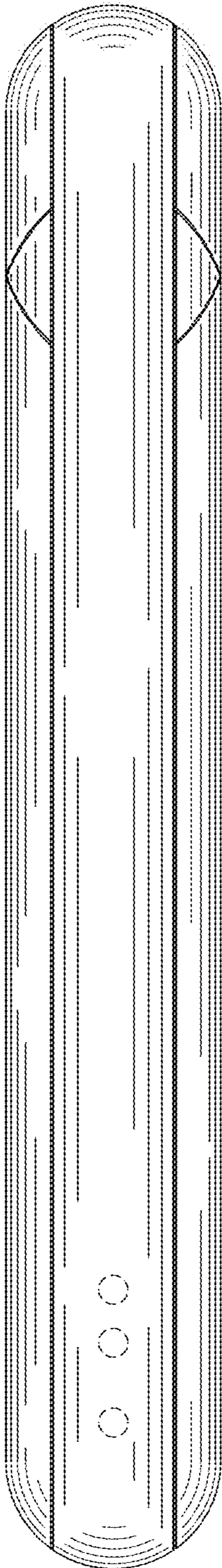

FIG. 4

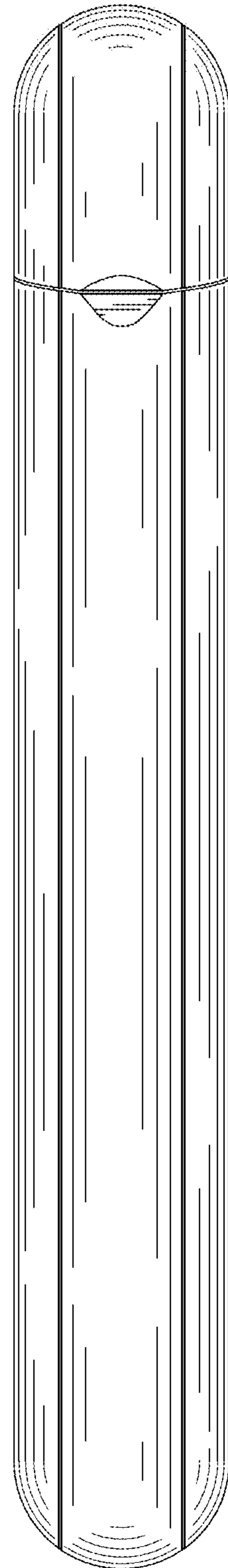

FIG. 5

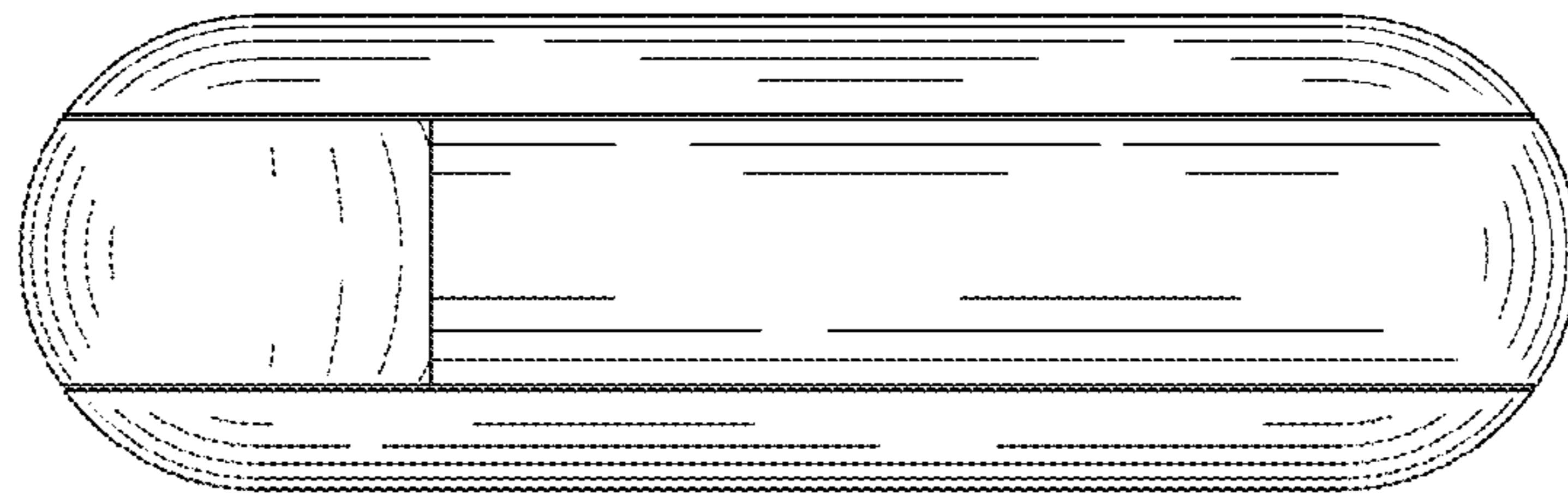

FIG. 6

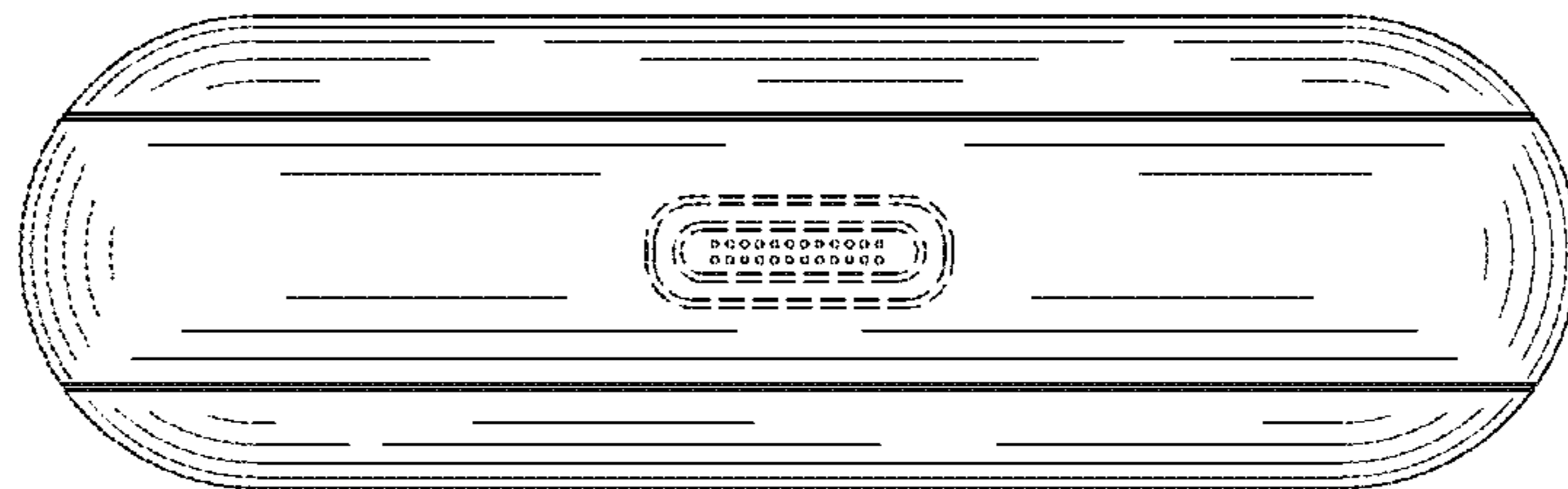

FIG. 7

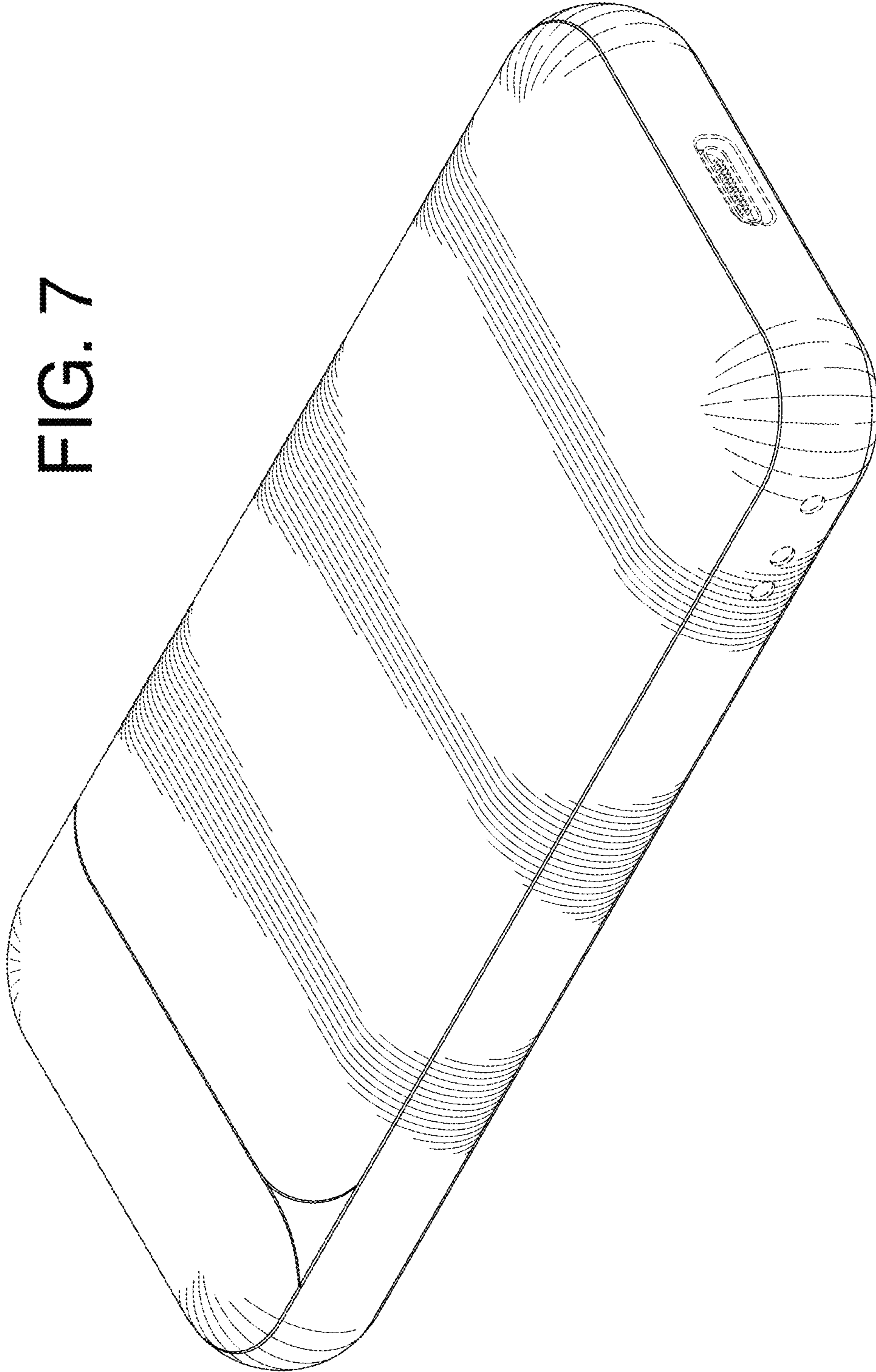

FIG. 8

