



US00D883176S

(12) **United States Design Patent** (10) **Patent No.:** **US D883,176 S**
Ajam et al. (45) **Date of Patent:** **** May 5, 2020**

(54) **ROLL BAR**
(71) Applicant: **Black Horse Off Road of GA Inc.**,
Royston, GA (US)
(72) Inventors: **Fadi Ajam**, Forest Hills, NY (US);
Matthew Kemme, Brooklyn, NY (US)
(73) Assignee: **Black Horse Off Road of GA Inc.**,
Royston, GA (US)

D763,170 S * 8/2016 Marankie D12/414
D809,990 S * 2/2018 Schlup, Jr. D12/222
D840,905 S * 2/2019 Parzyck D12/222
D840,906 S * 2/2019 Parzyck D12/222
D840,907 S * 2/2019 Parzyck D12/222
D861,575 S * 10/2019 Tang D12/406
D862,357 S * 10/2019 Bibb, VI D12/222
2005/0093320 A1 * 5/2005 Brauer B62D 33/0207
296/3

(**) Term: **15 Years**
(21) Appl. No.: **29/683,999**

* cited by examiner
Primary Examiner — Katrina A Betton
(74) *Attorney, Agent, or Firm* — Haynsworth Sinkler
Boyd, P.A.

(22) Filed: **Mar. 18, 2019**
(51) **LOC (12) Cl.** **12-16**
(52) **U.S. Cl.**
USPC **D12/222**
(58) **Field of Classification Search**
USPC D12/222, 223, 400-401, 404, 406, 412,
D12/414; D6/552; D26/31
CPC . B60J 1/06; B60R 27/00; B60R 21/02; B62D
33/02; B60Q 1/0483
See application file for complete search history.

(57) **CLAIM**
The ornamental design for a roll bar, as shown and
described.

(56) **References Cited**
U.S. PATENT DOCUMENTS
D669,840 S * 10/2012 Gros D12/406
D717,230 S * 11/2014 Fichter D12/414
D731,399 S * 6/2015 Bluhm D12/406

DESCRIPTION
FIG. 1 is a front perspective view of a roll bar depicting a
new design;
FIG. 2 is a back elevational view thereof;
FIG. 3 is a front elevational view thereof;
FIG. 4 is a left elevational view thereof;
FIG. 5 is a right elevational view thereof;
FIG. 6 is a top plan view thereof; and,
FIG. 7 is a bottom plan view thereof.
The broken line disclosures in the views represent portions
of the roll bar that form no part of the claimed design.

1 Claim, 6 Drawing Sheets

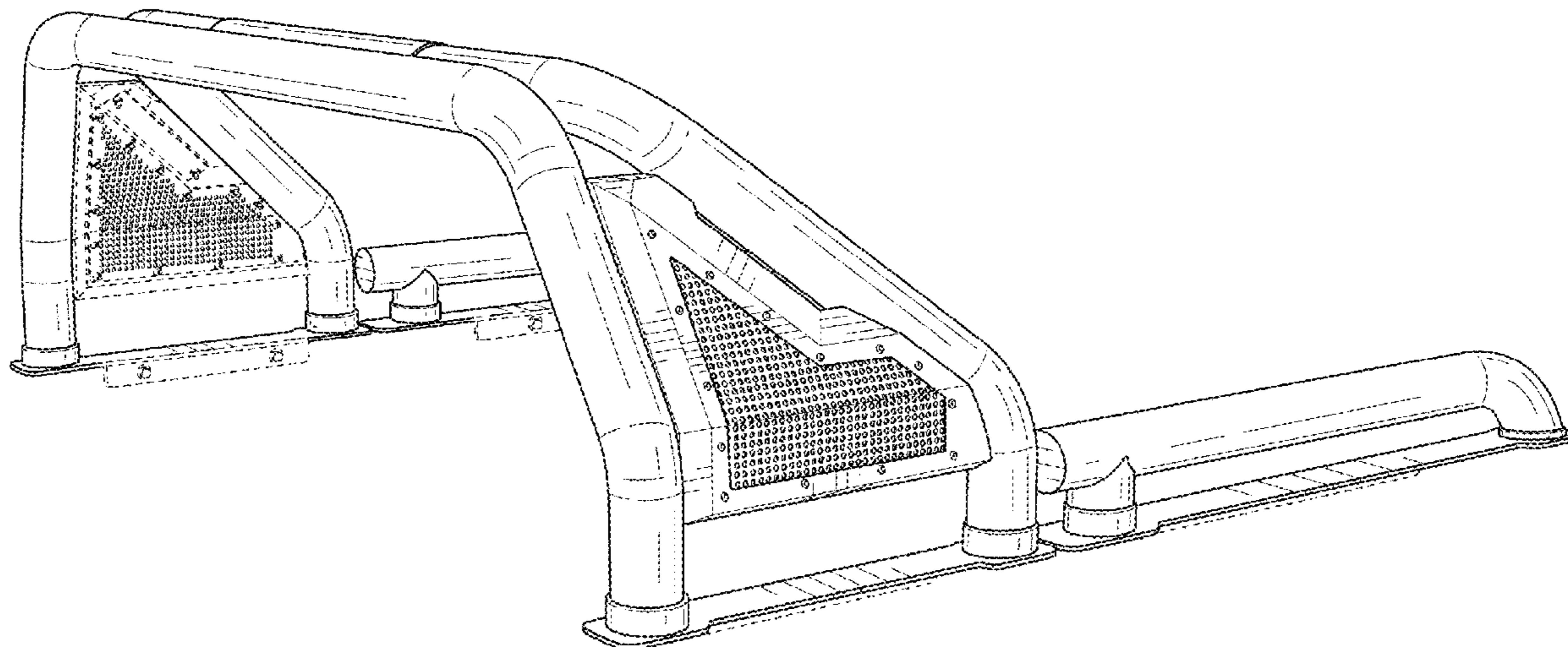

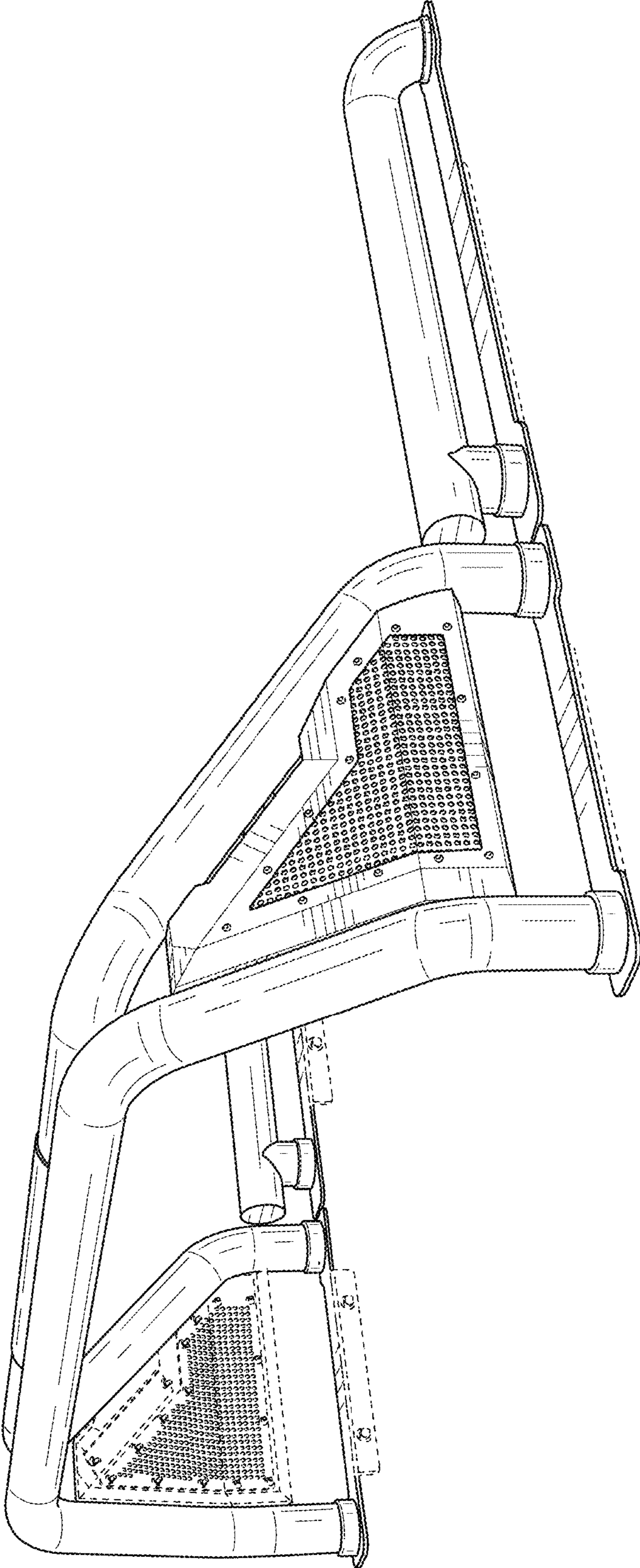

FIG. 1

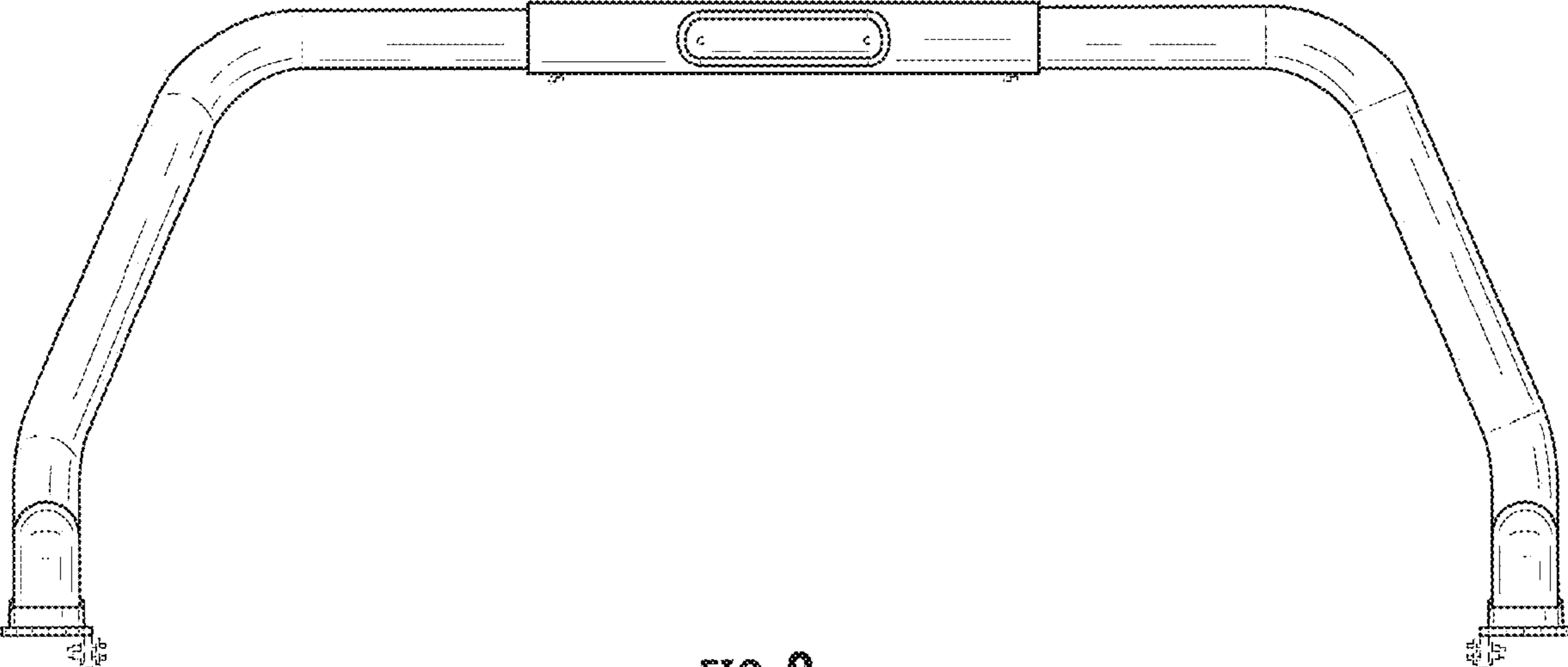

FIG. 2

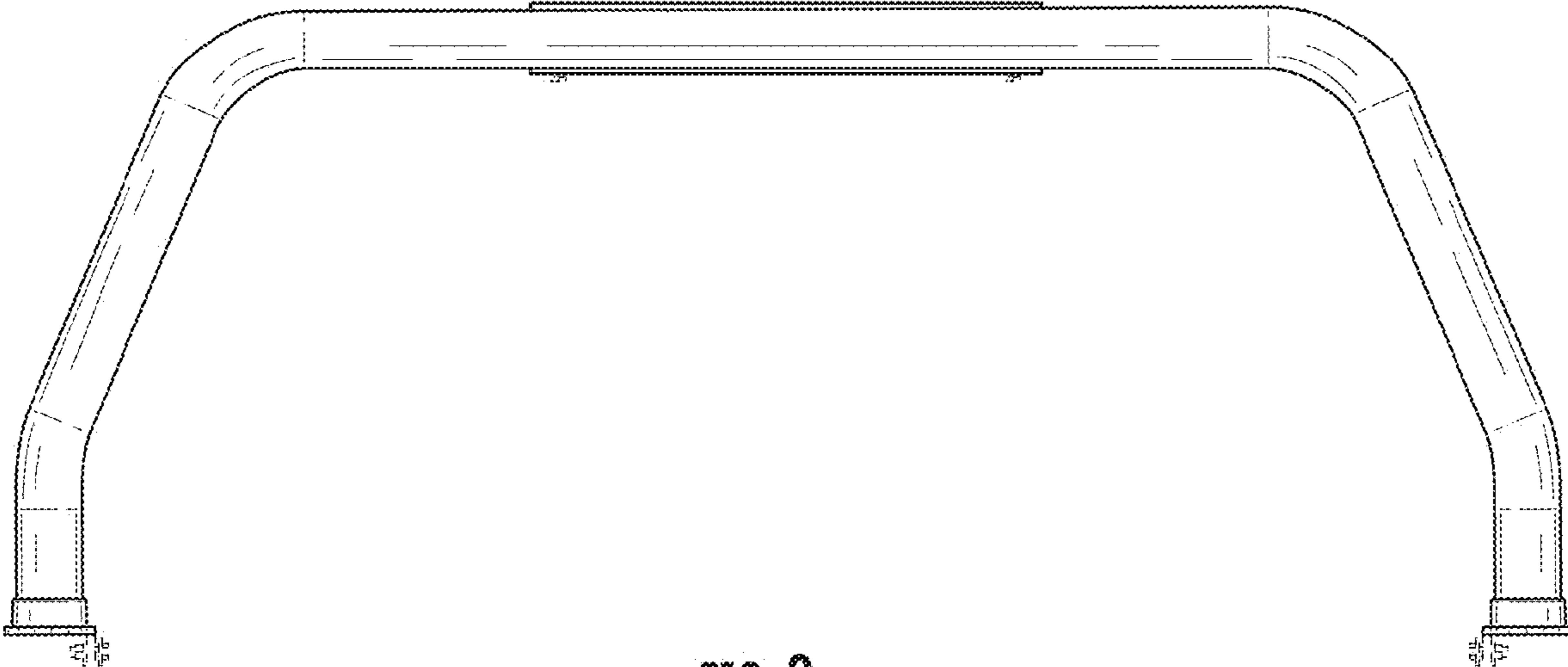

FIG. 3

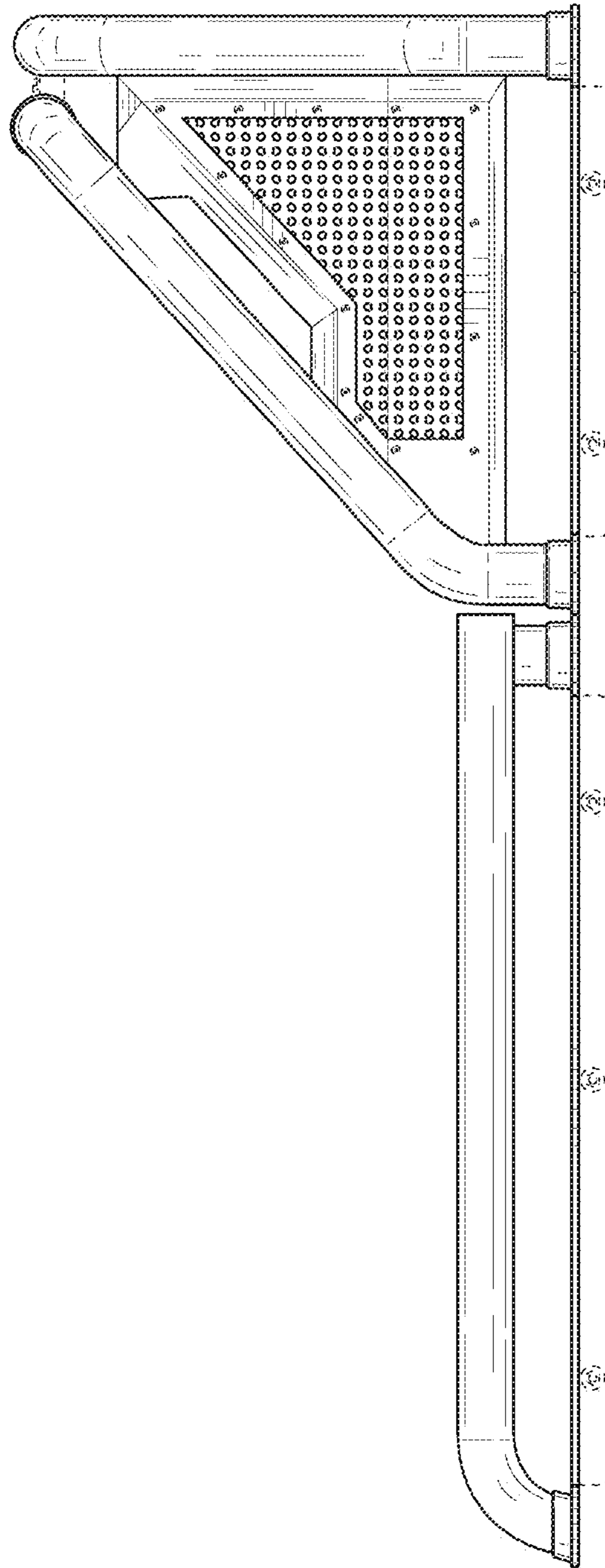

FIG. 4

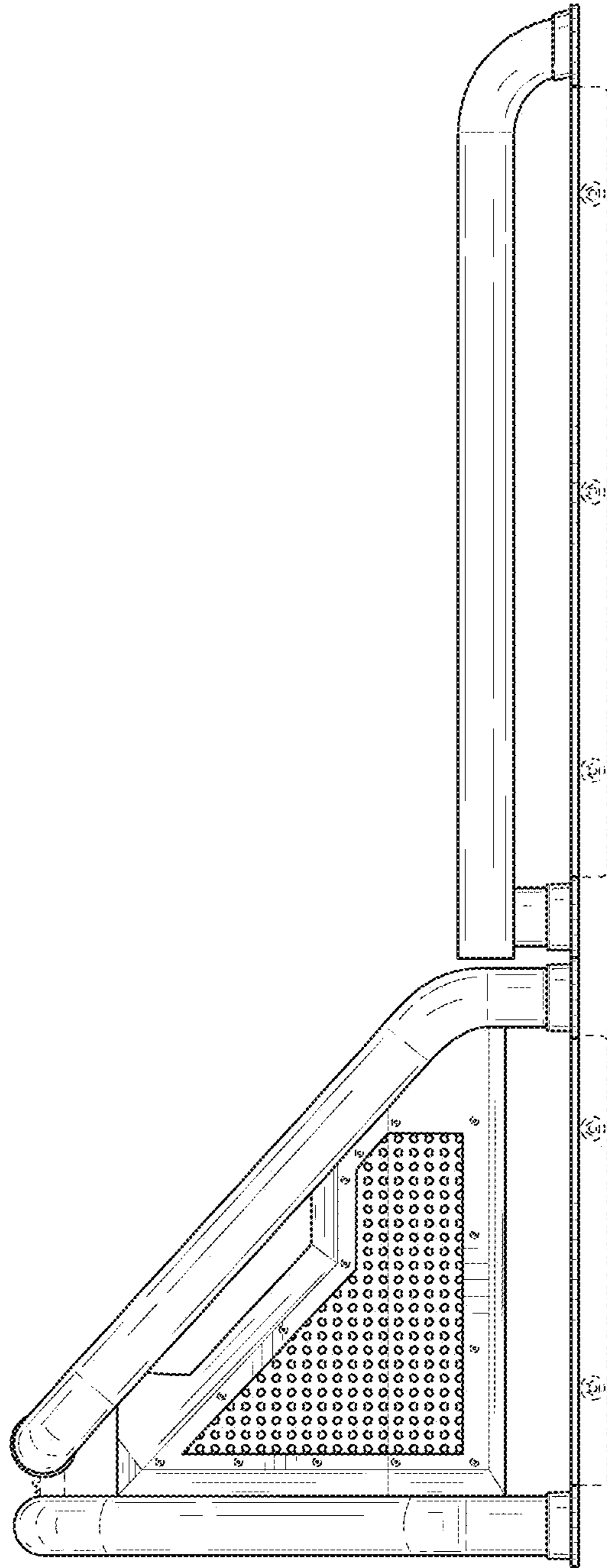

FIG. 5

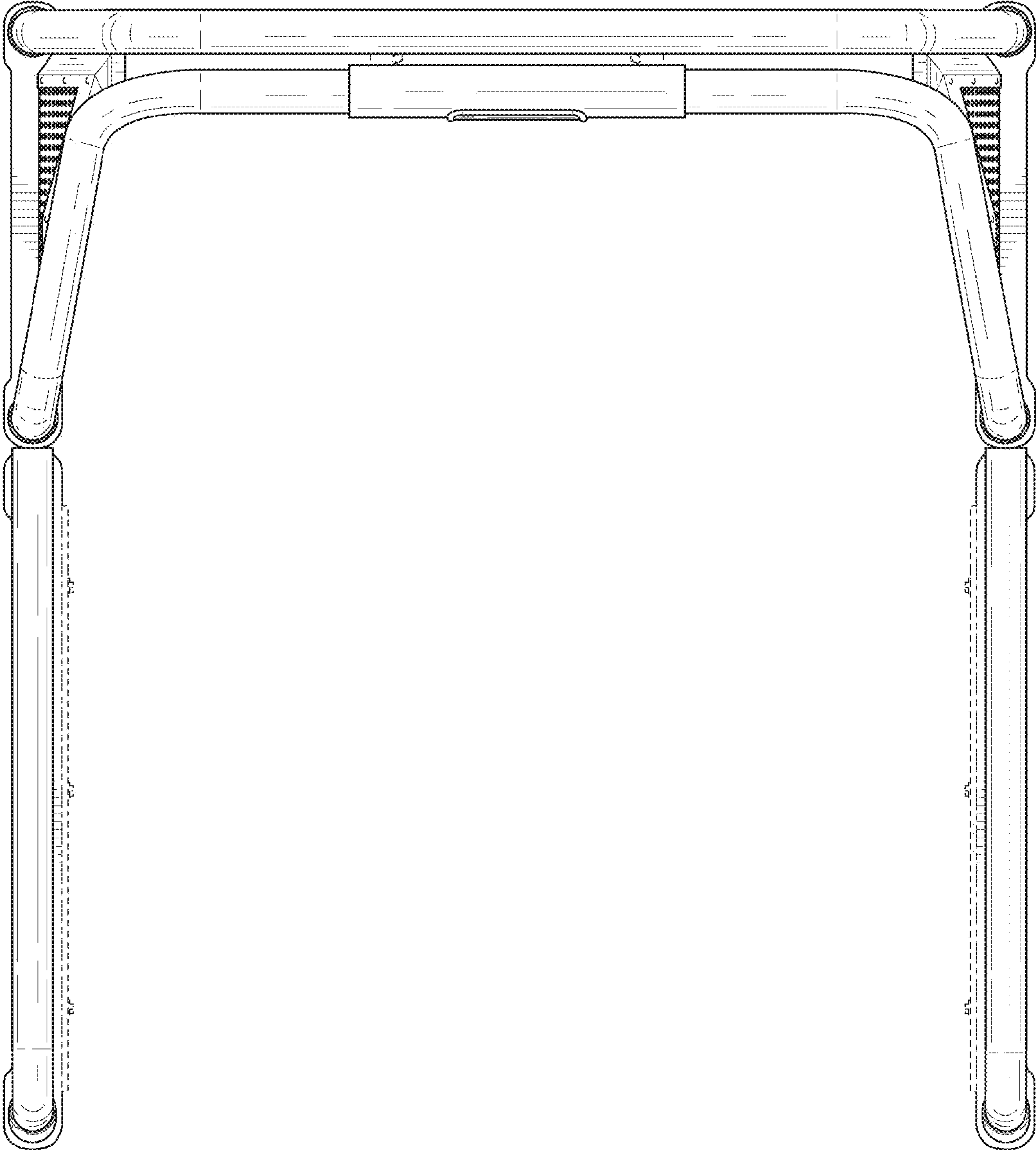

FIG. 6

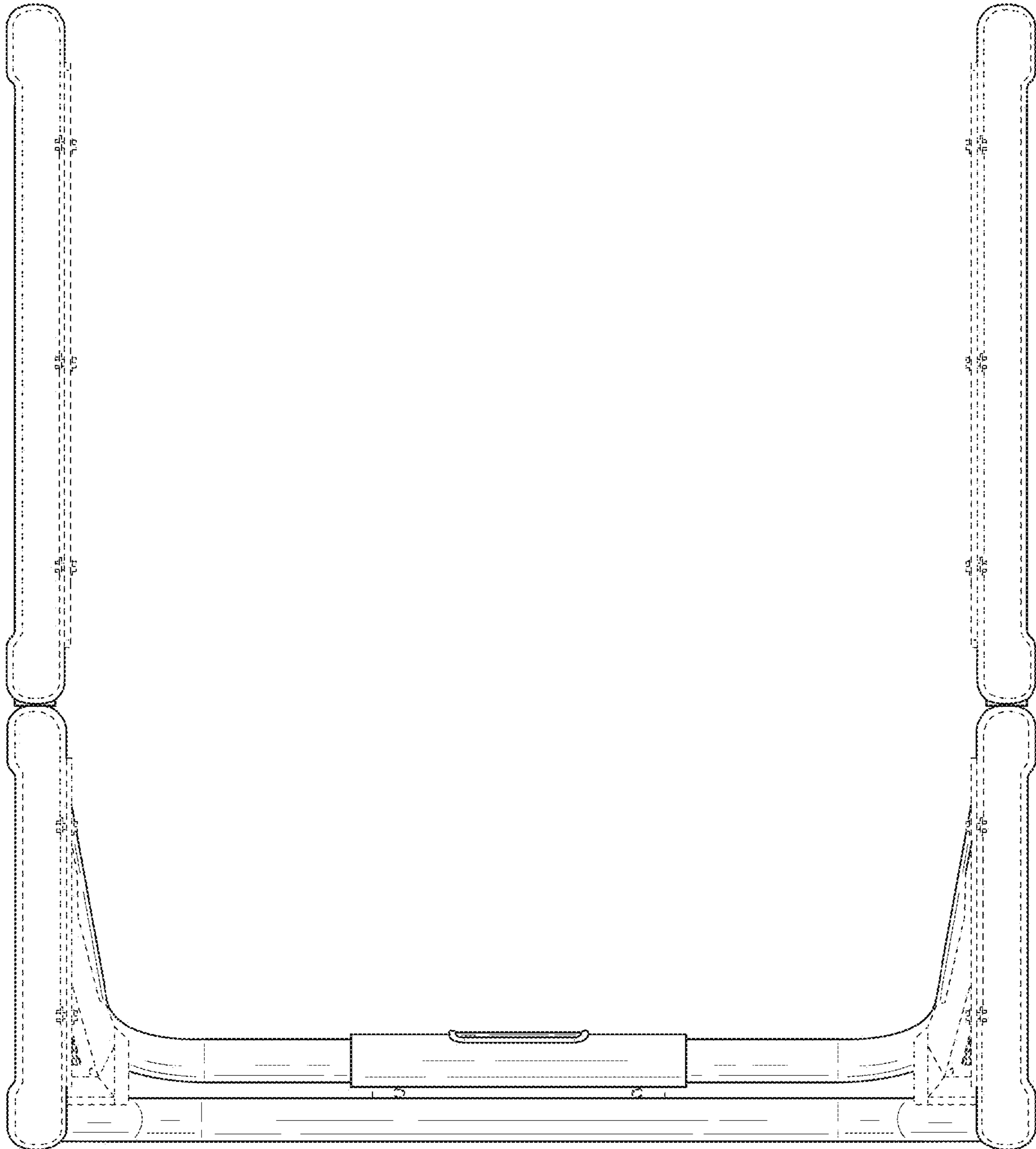

FIG. 7