



US00D883102S

(12) **United States Design Patent** (10) **Patent No.:** **US D883,102 S**
Hardy et al. (45) **Date of Patent:** **** May 5, 2020**

(54) **FOOD PACKAGE**

(71) Applicants: **General Mills, Inc.**, Minneapolis, MN (US); **Mark Griffin**, Apple Valley, CA (US)

(72) Inventors: **Suzanne Hardy**, Minneapolis, MN (US); **Scott F Gillespie**, Littleton, CO (US); **Mark Griffin**, Apple Valley, CA (US)

(73) Assignee: **General Mills, Inc.**, Minneapolis, MN (US)

(**) Term: **15 Years**

(21) Appl. No.: **29/663,845**

(22) Filed: **Sep. 19, 2018**

Related U.S. Application Data

(62) Division of application No. 29/558,722, filed on Mar. 21, 2016, now Pat. No. Des. 831,499.

(51) **LOC (12) Cl.** **09-05**

(52) **U.S. Cl.**
USPC **D9/707**

(58) **Field of Classification Search**
USPC D9/702-714, 720-722, 416-417, D9/695-696; D24/118-119, 207;
(Continued)

(56) **References Cited**

U.S. PATENT DOCUMENTS

D316,668 S 5/1991 Wortley et al.
D419,435 S 1/2000 Bonfigli
(Continued)

Primary Examiner — Abraham Bahta

(74) *Attorney, Agent, or Firm* — Diederiks & Whitelaw, PLC; Annette M. Frawley, Esq.

(57) **CLAIM**

The ornamental design for food package, as shown and described.

DESCRIPTION

FIG. 1 is a front perspective view of the food package showing our new design;
FIG. 2 is a back view thereof;
FIG. 3 is a front view thereof;
FIG. 4 is a right side view thereof;
FIG. 5 is a left side view thereof;
FIG. 6 is a top view thereof; and
FIG. 7 is a bottom view thereof.
FIG. 8 is a front perspective view of another embodiment of the food package of our design;
FIG. 9 is a back view thereof;
FIG. 10 is a front view thereof;
FIG. 11 is a right side view thereof;
FIG. 12 is a left side view thereof;
FIG. 13 is a top view thereof; and
FIG. 14 is a bottom view thereof.
FIG. 15 is a front perspective view of another embodiment of the food package of our design;
FIG. 16 is a back view thereof;
FIG. 17 is a front view thereof;
FIG. 18 is a right side view thereof;
FIG. 19 is a left side view thereof;
FIG. 20 is a top view thereof; and
FIG. 21 is a bottom view thereof.
FIG. 22 is a front perspective view of another embodiment of the food package of our design;
FIG. 23 is a back view thereof;
FIG. 24 is a front view thereof;
FIG. 25 is a right side view thereof;
FIG. 26 is a left side view thereof;
FIG. 27 is a top view thereof; and
FIG. 28 is a bottom view thereof.

The dash-dot-dot-dash break-away portions shown in FIGS. 8-12 and 22-26 are included to show that the food package has no specific length.

(Continued)

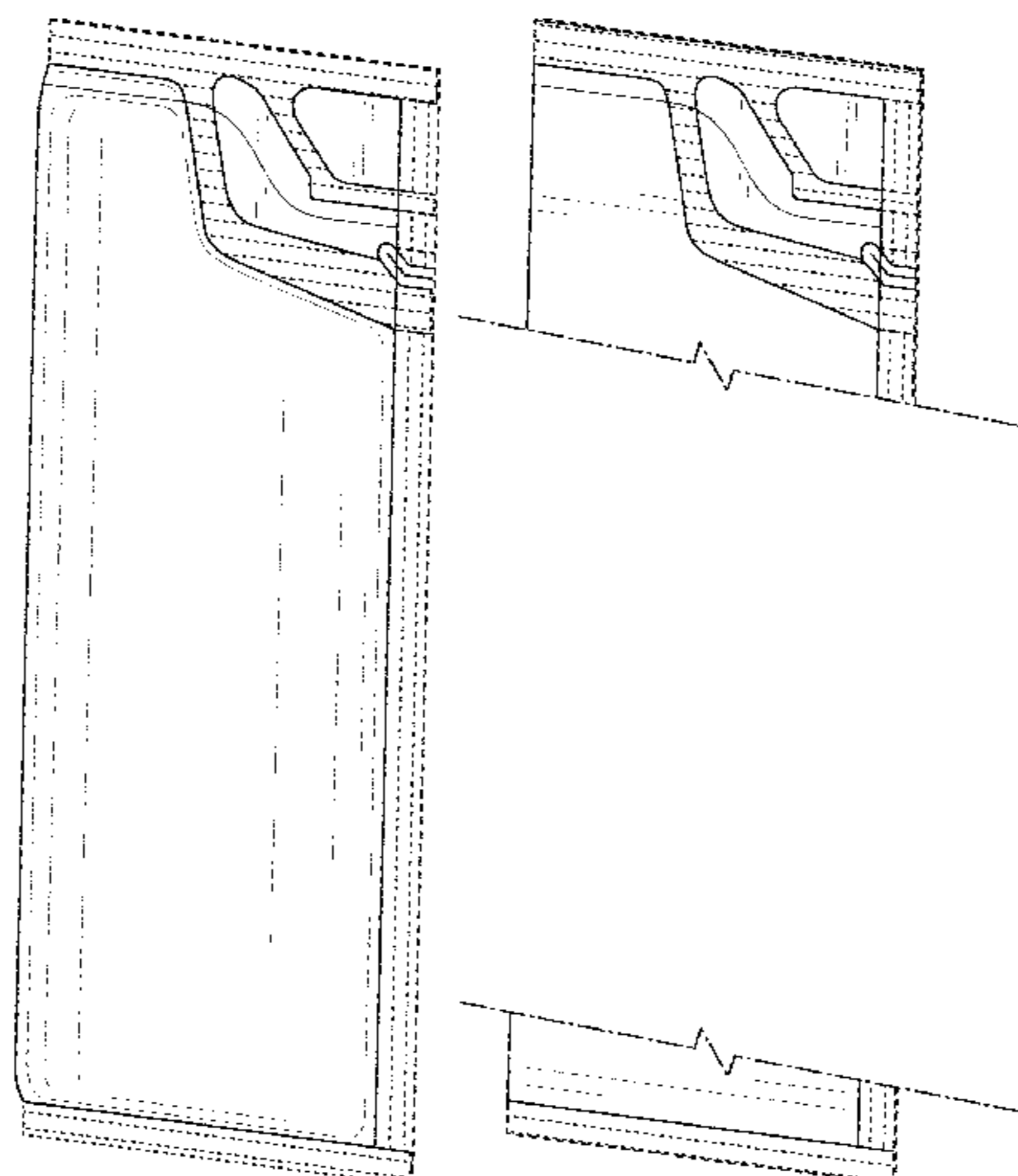

The broken line showing portions of the food package is included for the purpose of illustrating environmental structure and forms no part of the claimed design.

1 Claim, 20 Drawing Sheets

(58) **Field of Classification Search**

USPC .. 383/200, 207, 38, 208–209, 63, 61.1, 113;
229/87.06, 87.03, 87.08; 426/106, 115,
426/119–120, 122, 410; 222/94, 107,
222/541.1, 92, 541.2; 206/811, 229, 484;
219/727
CPC ... B65D 1/00; B65D 1/09; B65D 1/32; B65D
11/00; B65D 11/18; B65D 11/10; B65D
35/38; B65D 35/02; B65D 35/08; B65D
35/44; B65D 35/00; B65D 35/28; B65D
17/00; B65D 17/16; B65D 17/161; B65D
17/163; B65D 17/20

See application file for complete search history.

(56) **References Cited**

U.S. PATENT DOCUMENTS

D620,372 S	7/2010	Latour	
D630,522 S	1/2011	Harvey et al.	
D640,566 S	6/2011	Norlin et al.	
D688,567 S	8/2013	Stronski	
D724,440 S	3/2015	Ulstad et al.	
D772,724 S	11/2016	Boekeloo et al.	
D773,313 S	12/2016	Singer	
D831,499 S *	10/2018	Hardy	D9/707

* cited by examiner

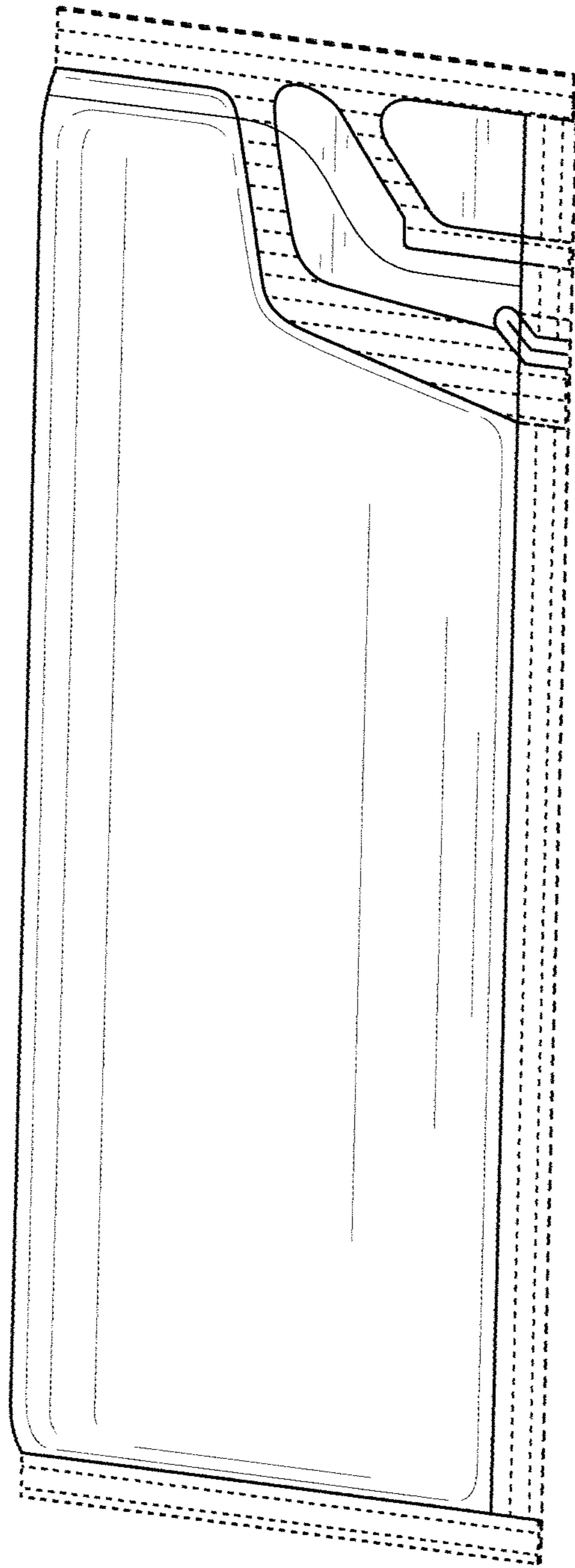

FIG. 1

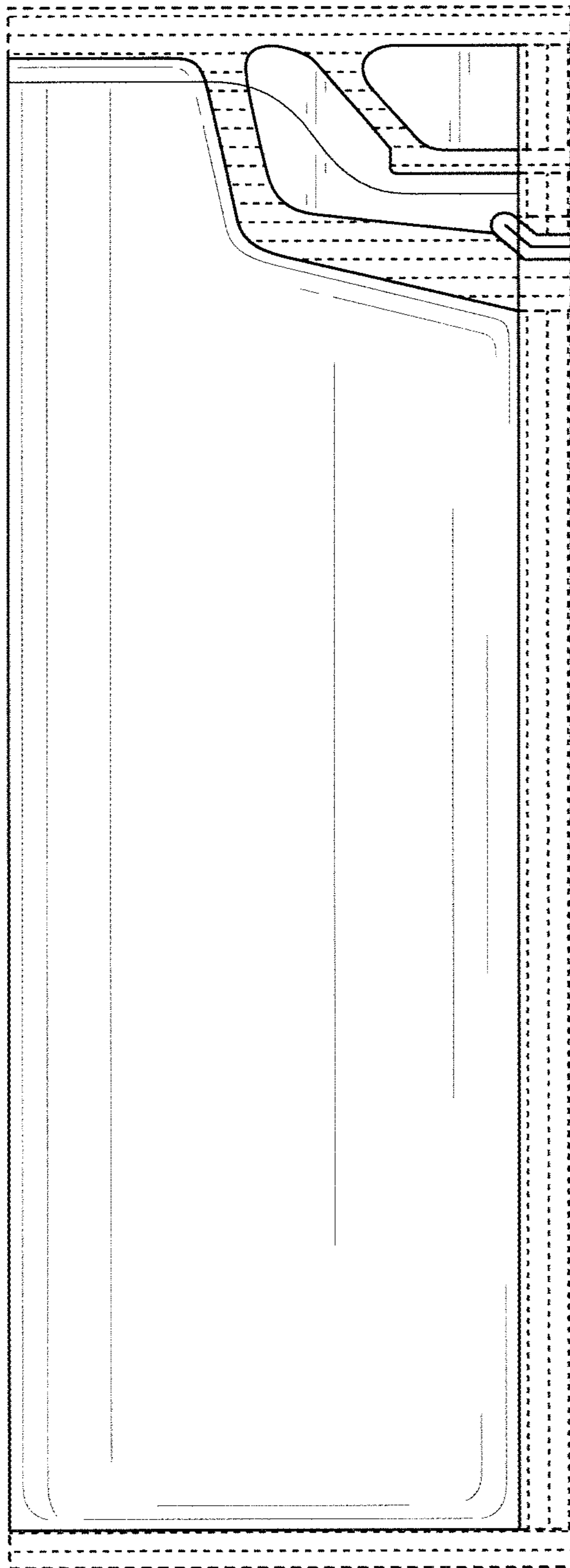

FIG. 2

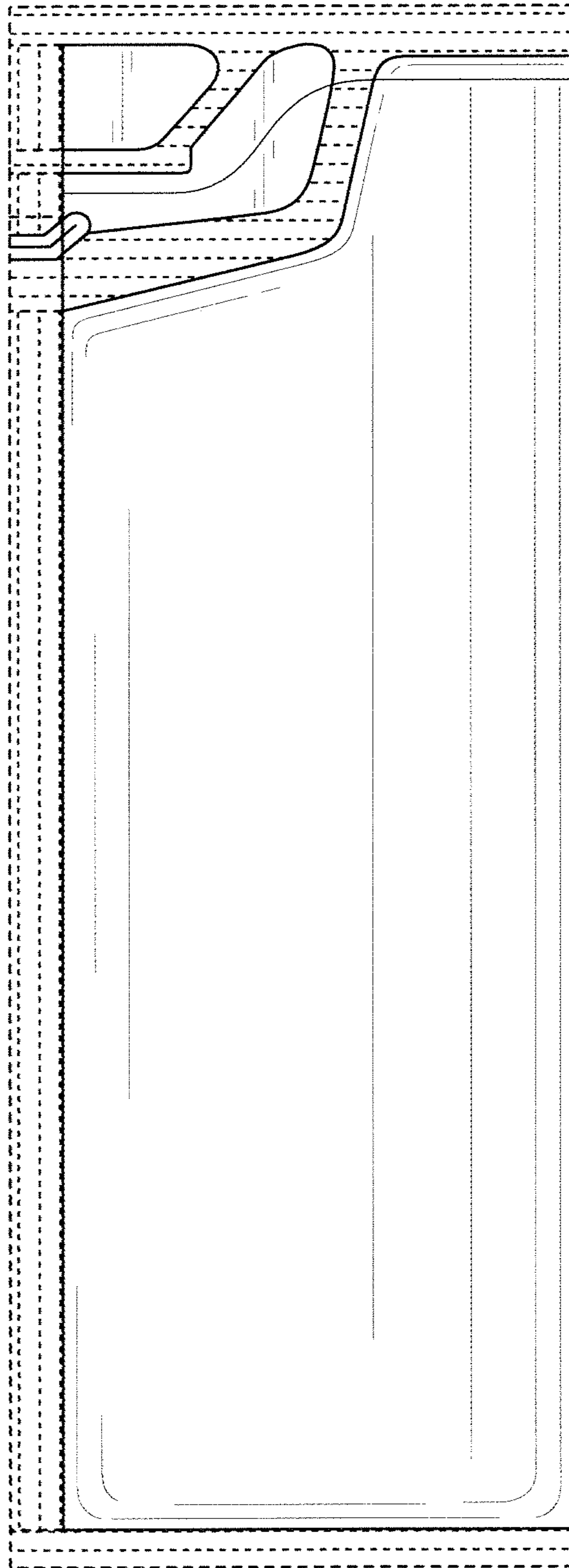

FIG. 3

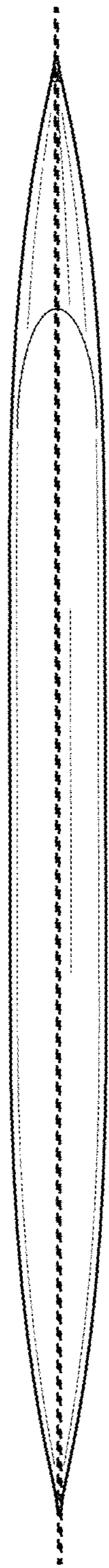

FIG. 4

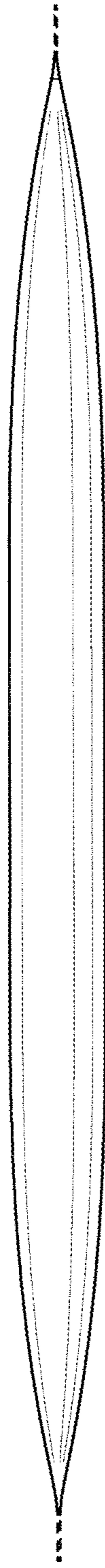

FIG. 5

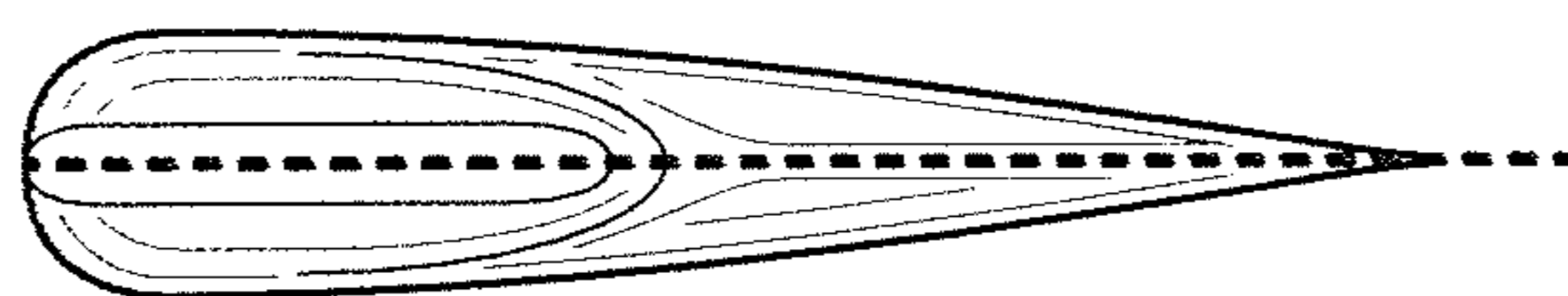

FIG. 6

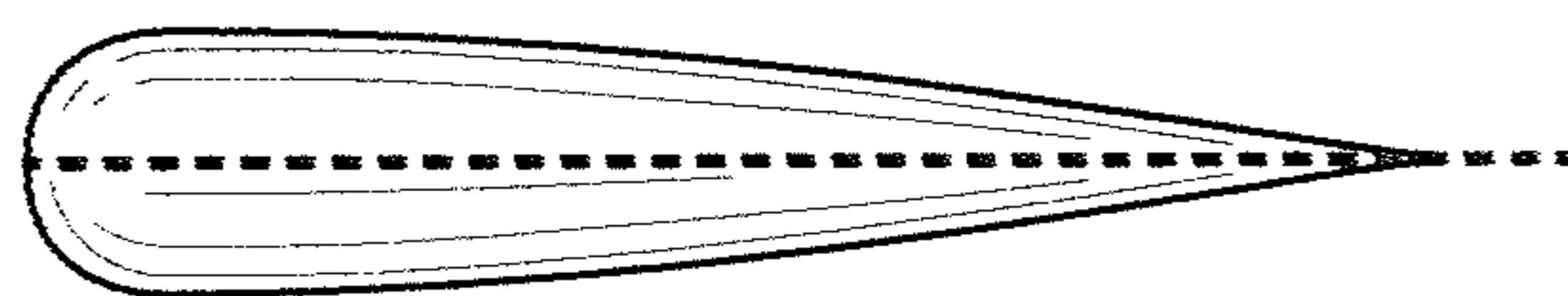

FIG. 7

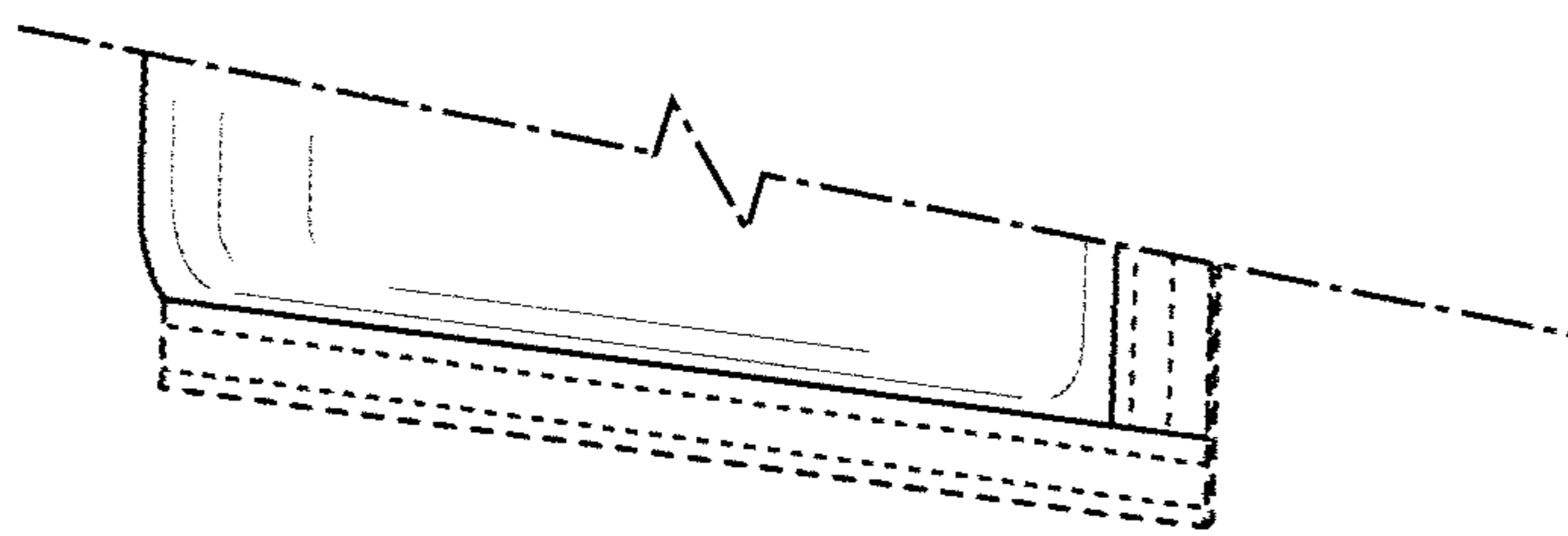
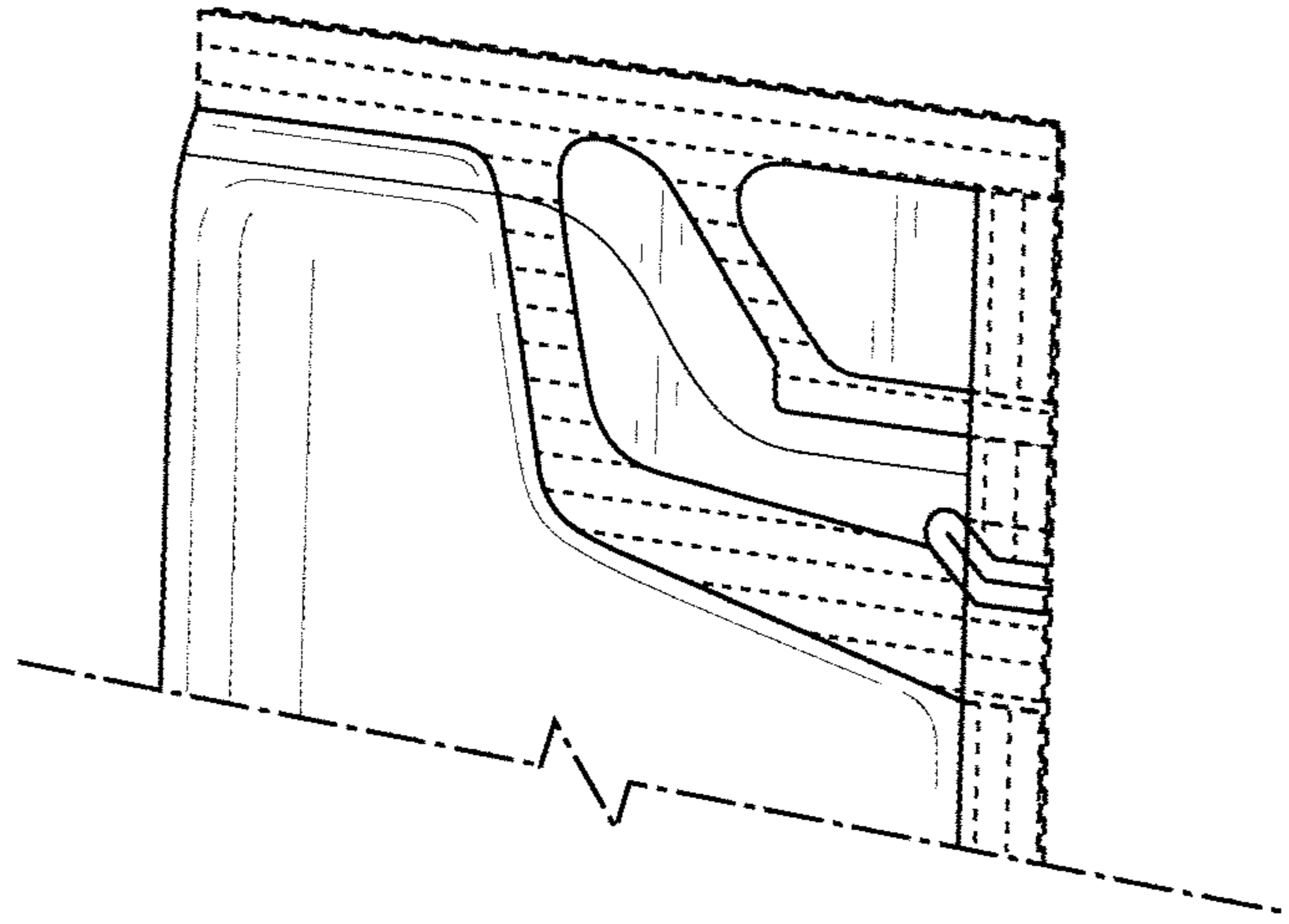

FIG. 8

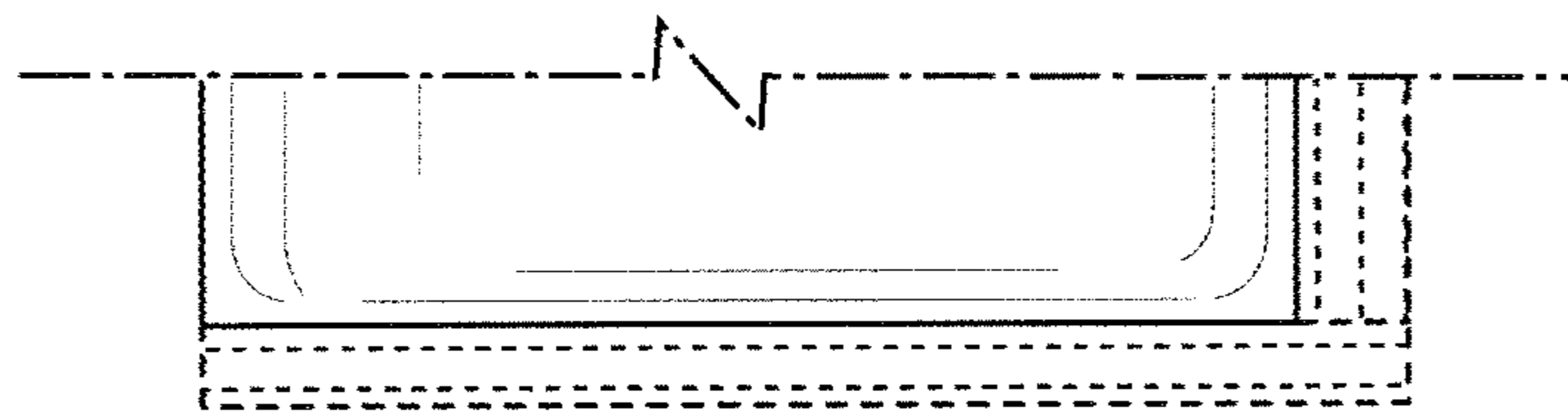
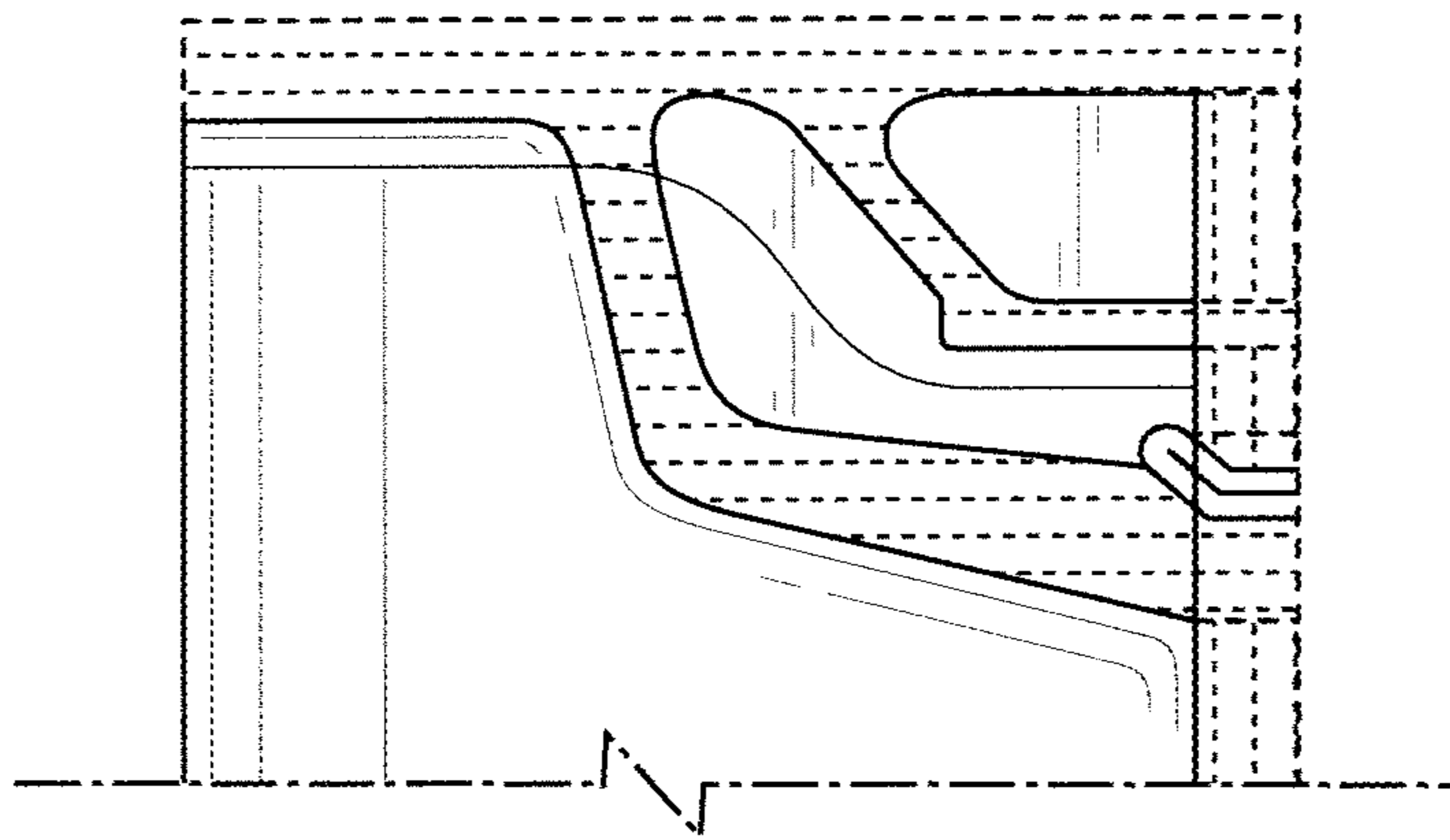

FIG. 9

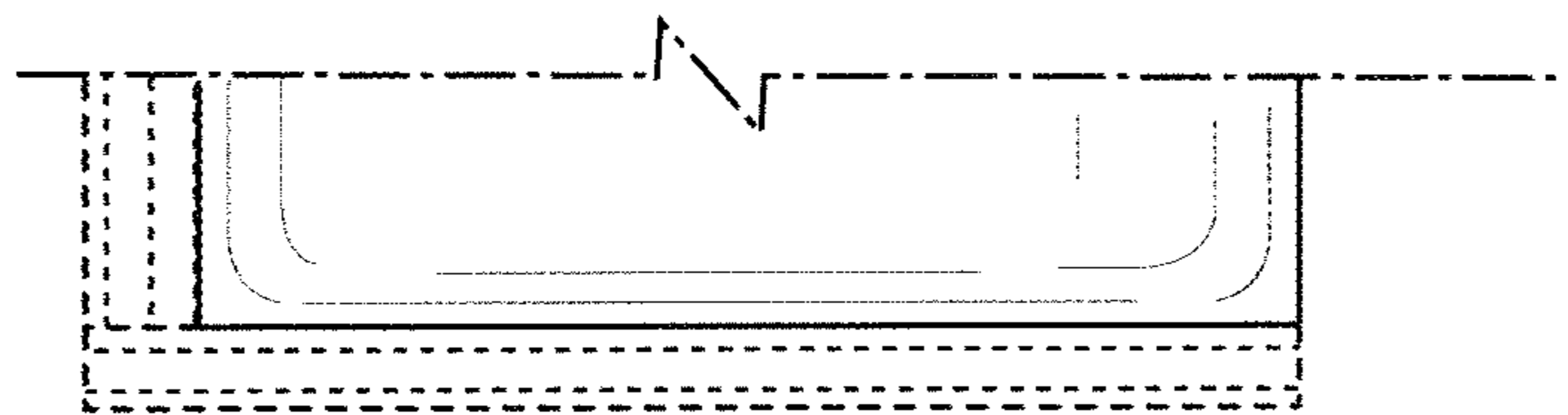
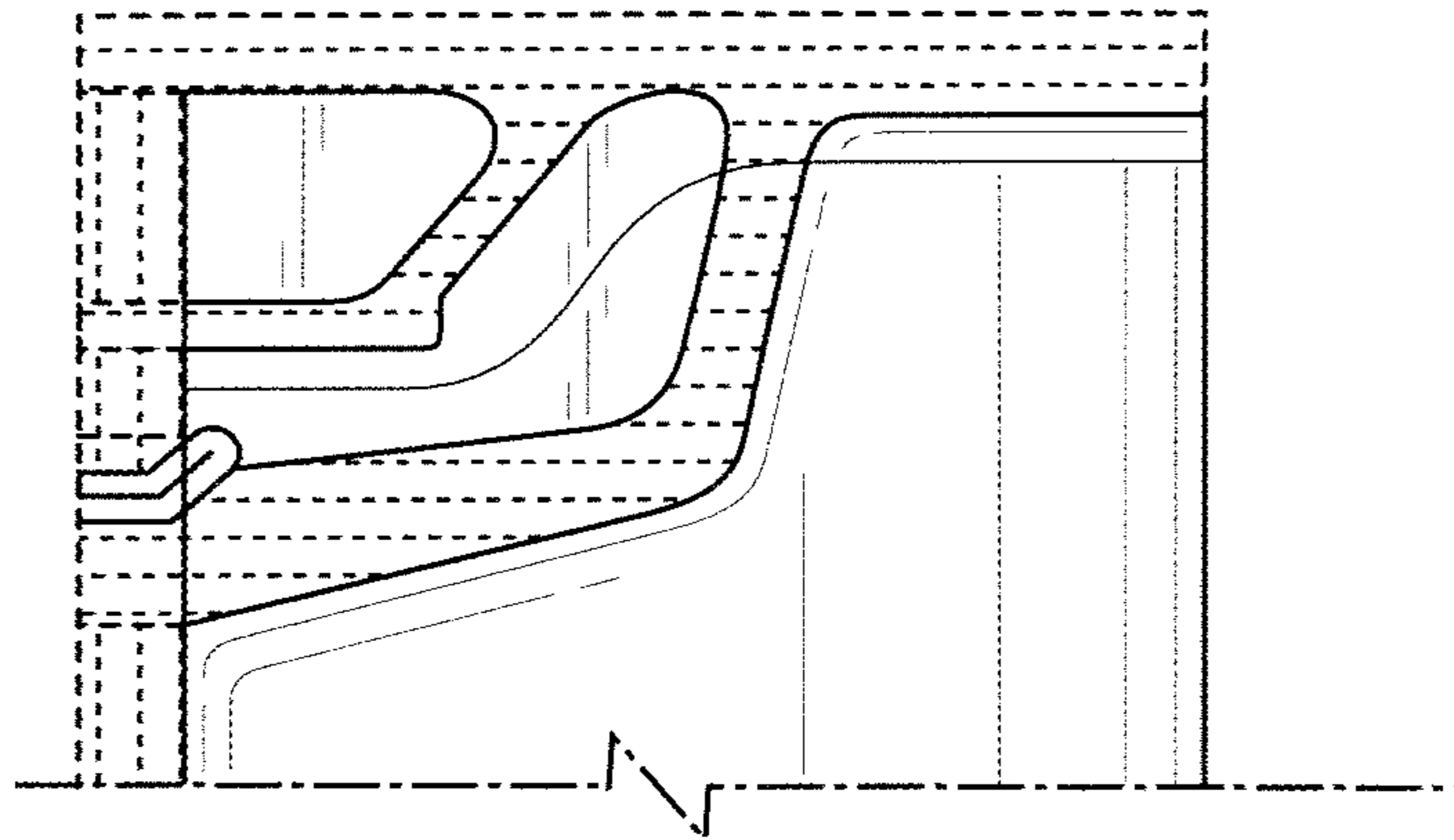

FIG. 10

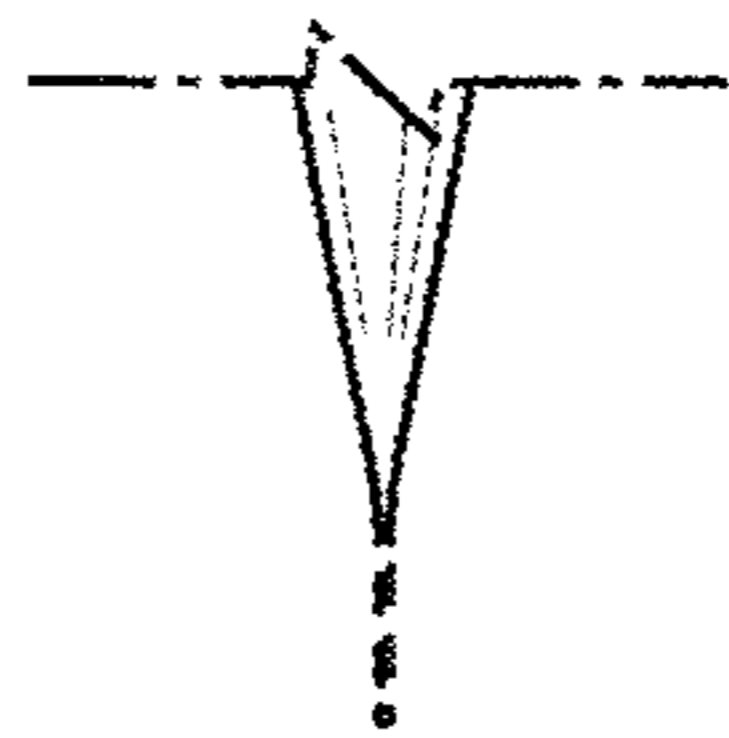
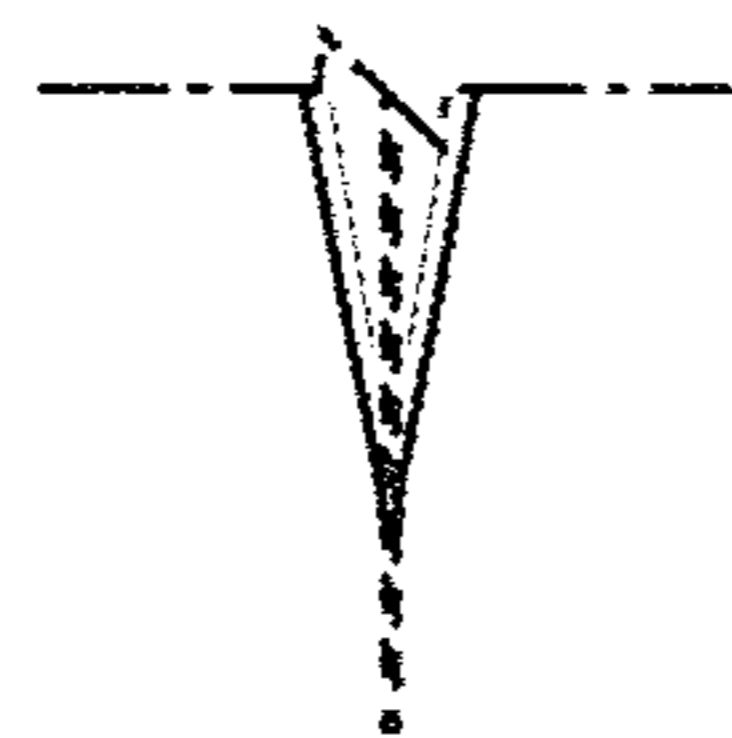
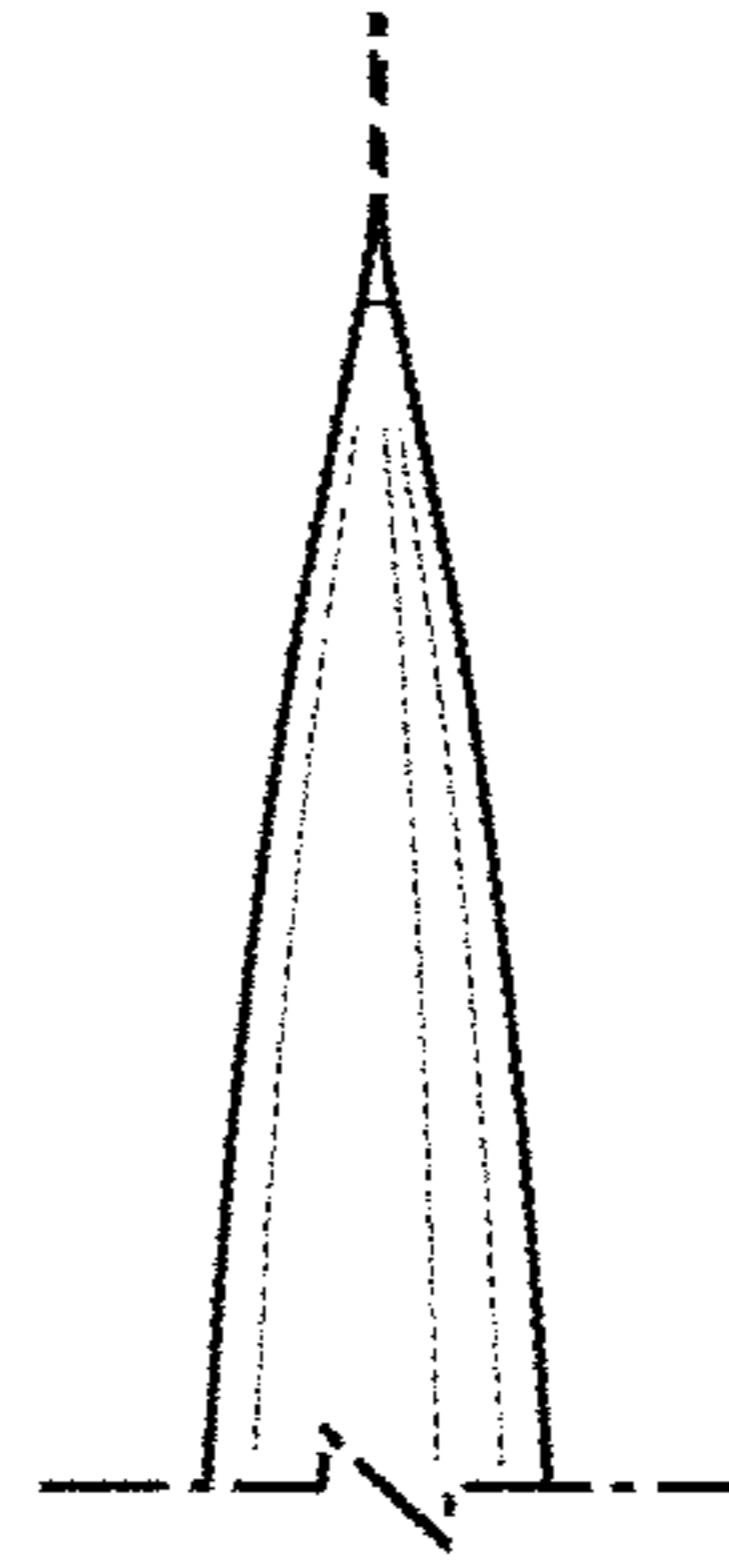
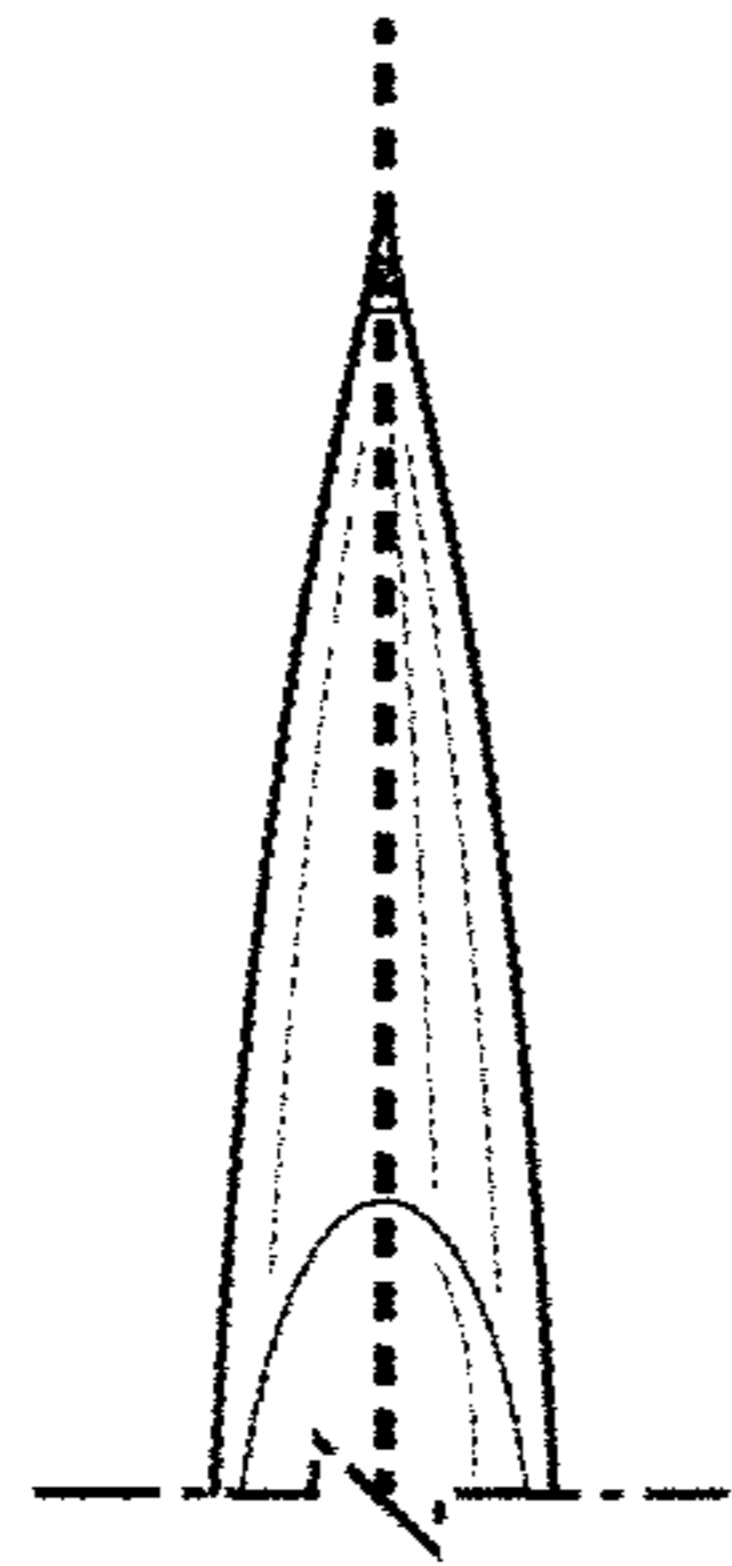

FIG. 11

FIG. 12

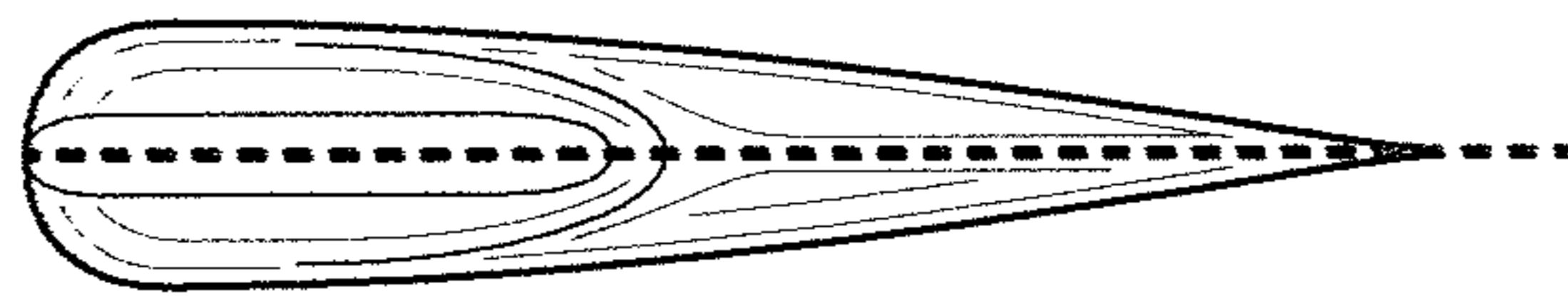

FIG. 13

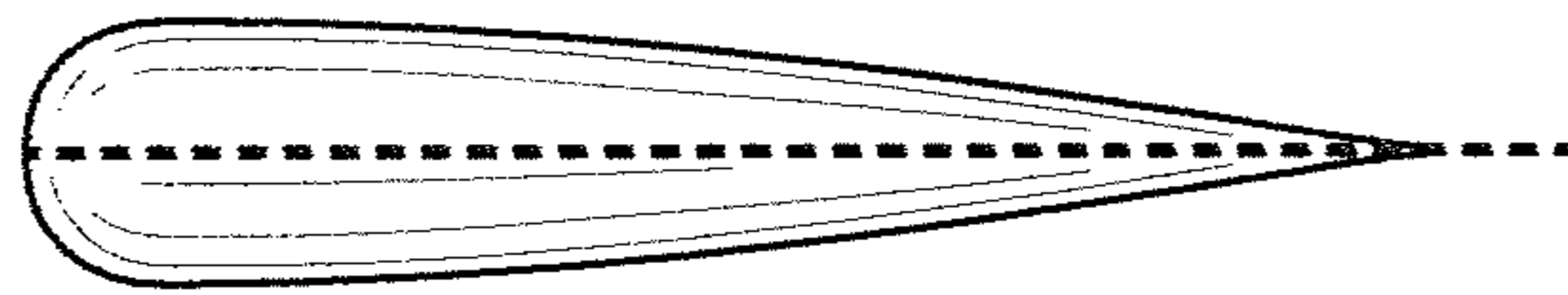

FIG. 14

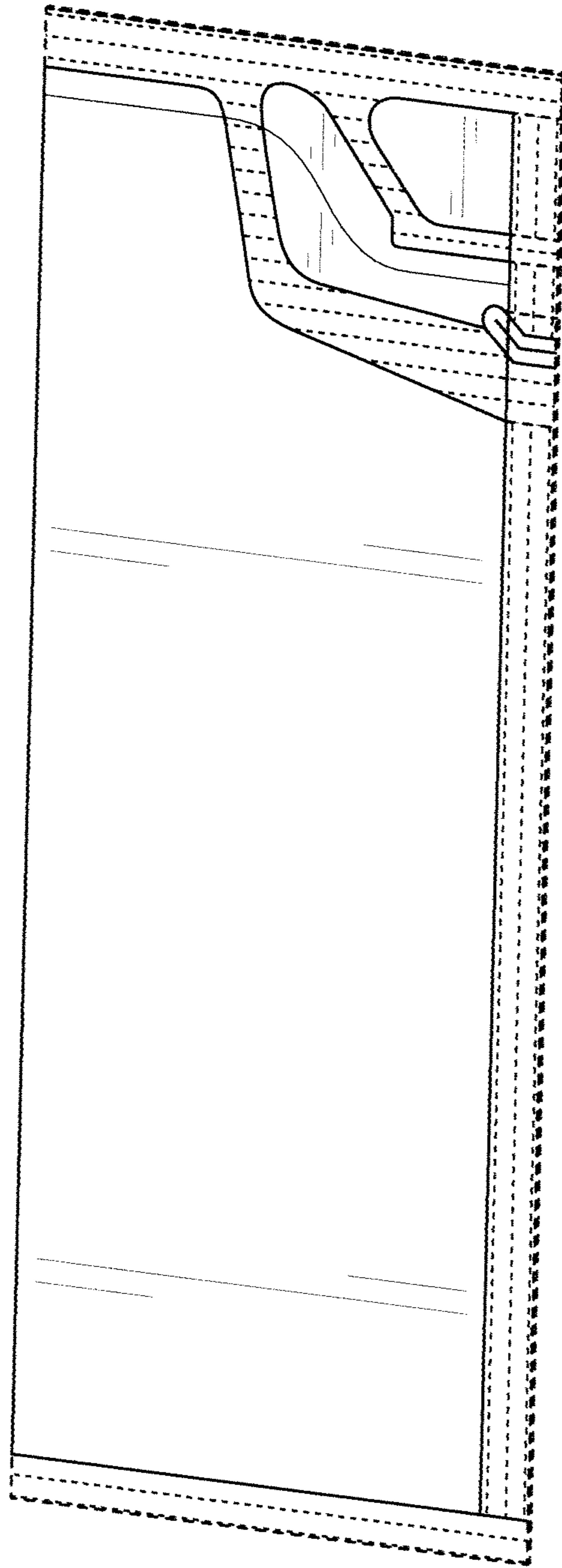

FIG. 15

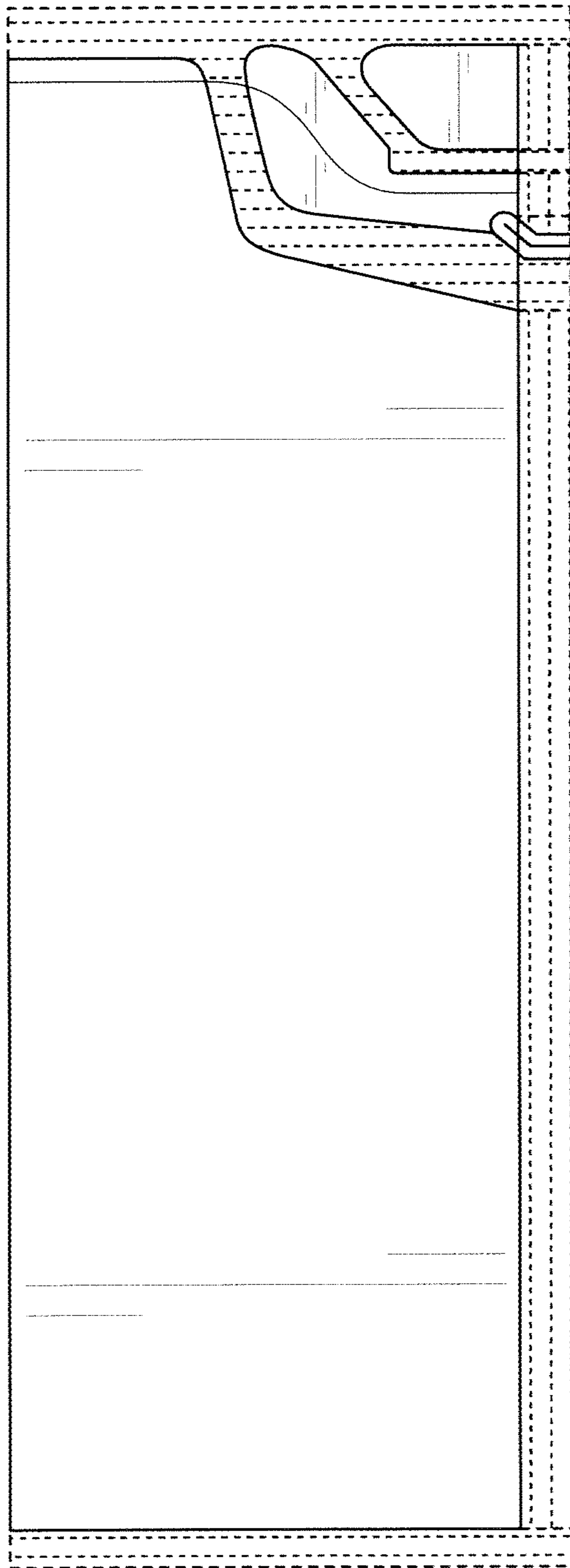

FIG. 16

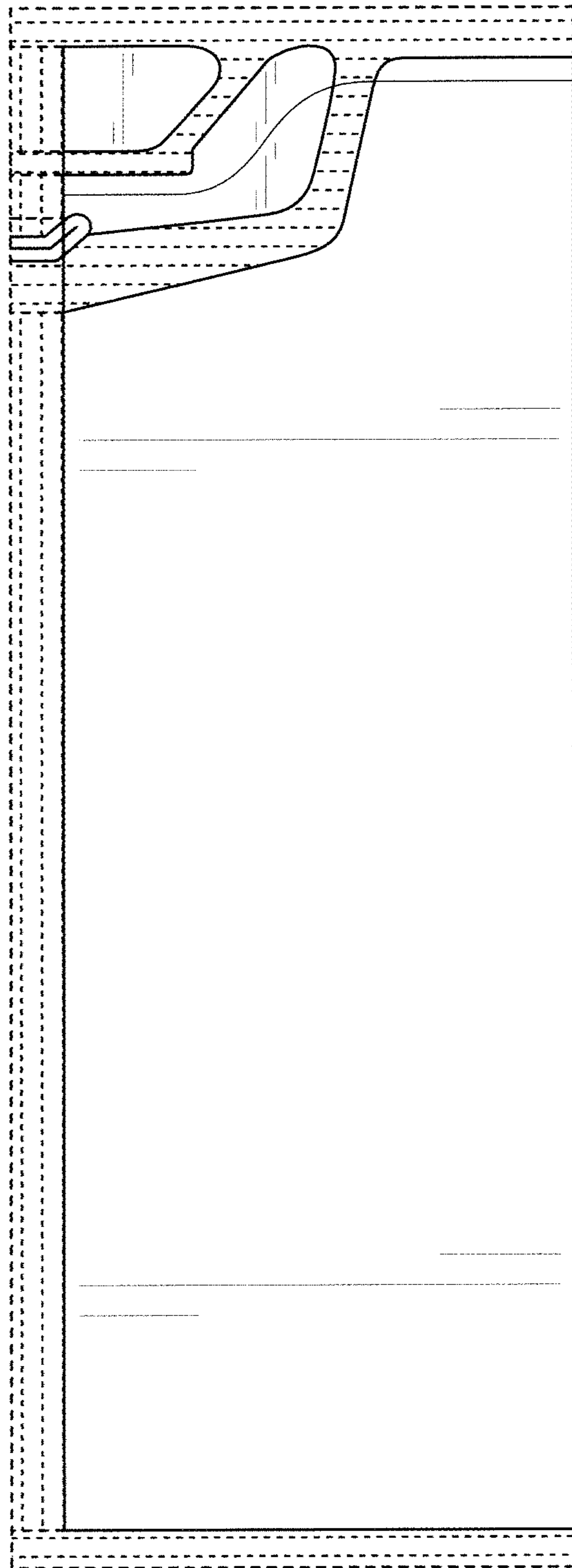

FIG. 17



FIG. 18



FIG. 19



FIG. 20



FIG. 21

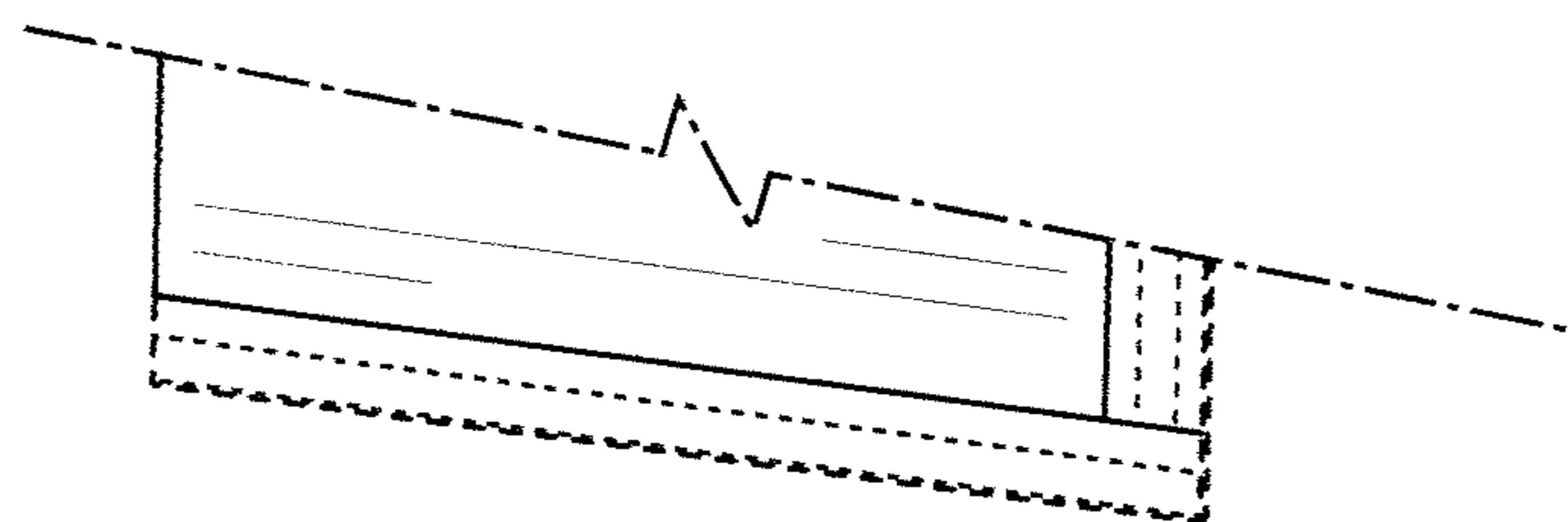
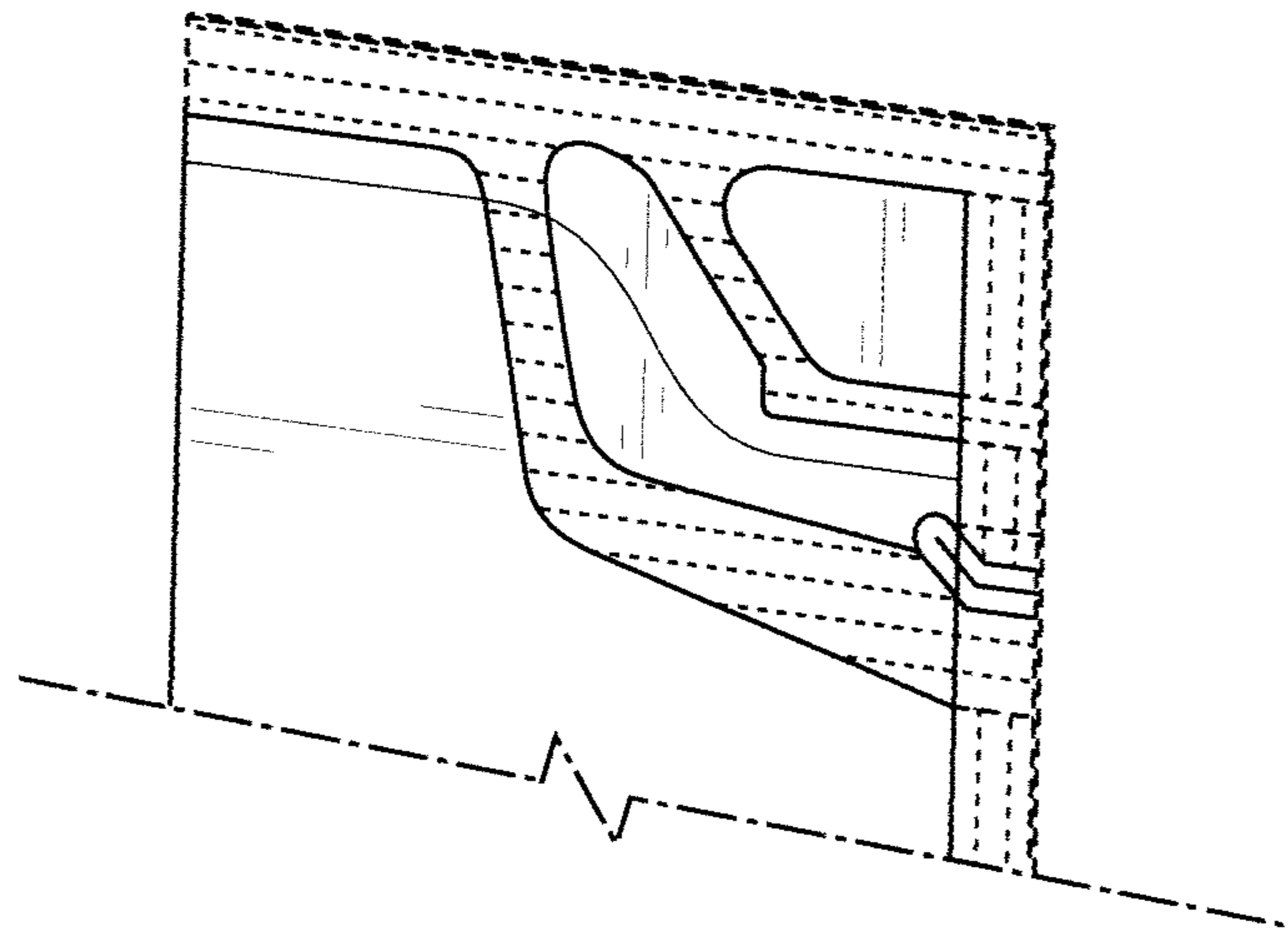

FIG. 22

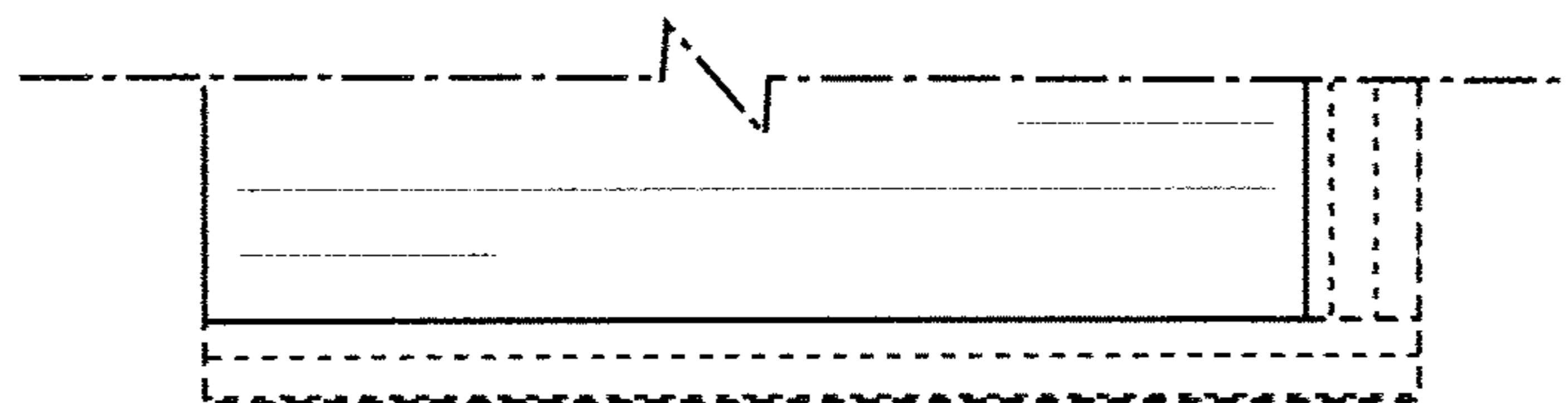
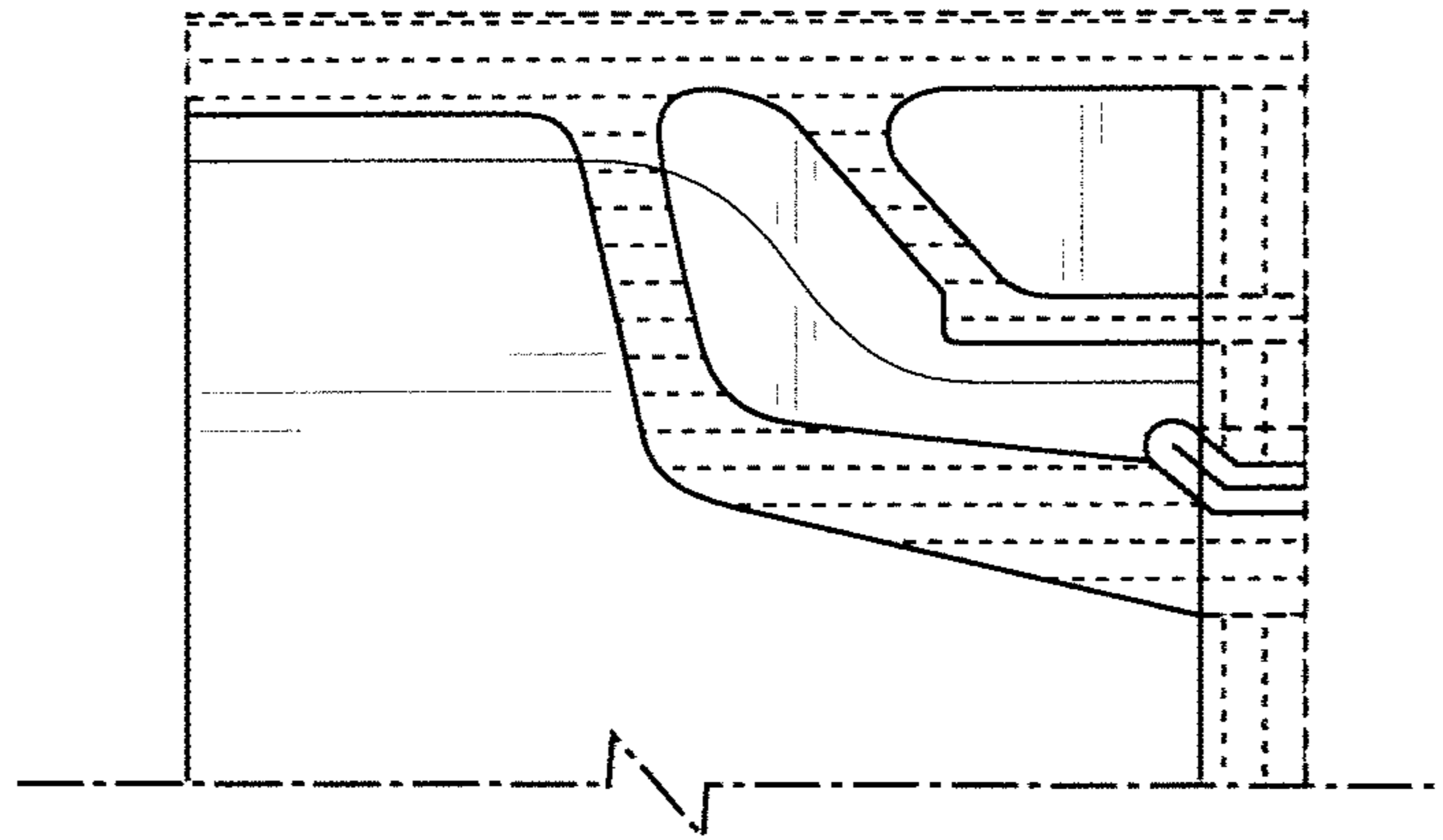

FIG. 23

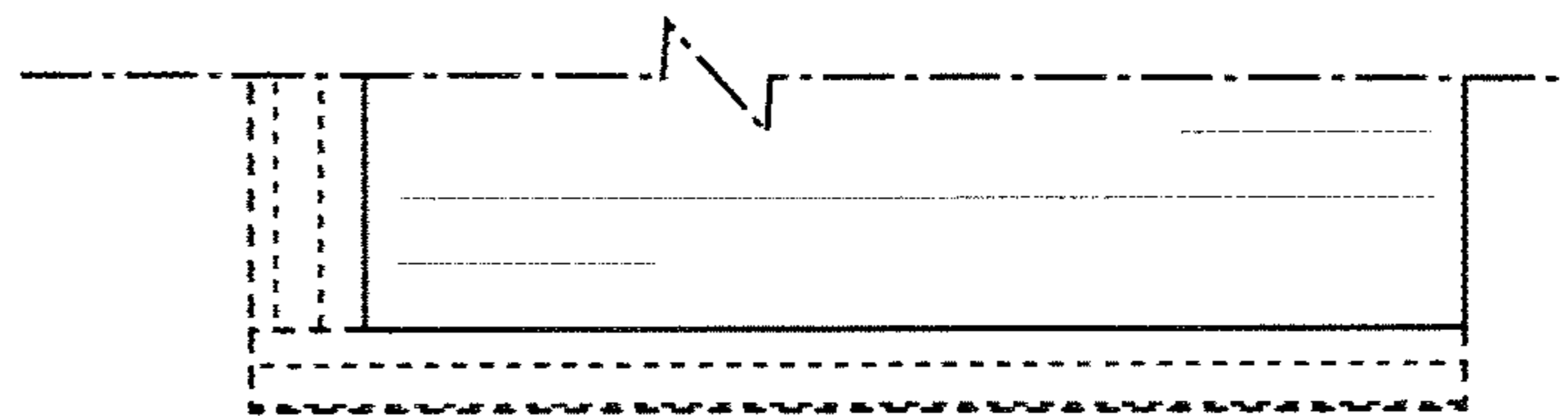
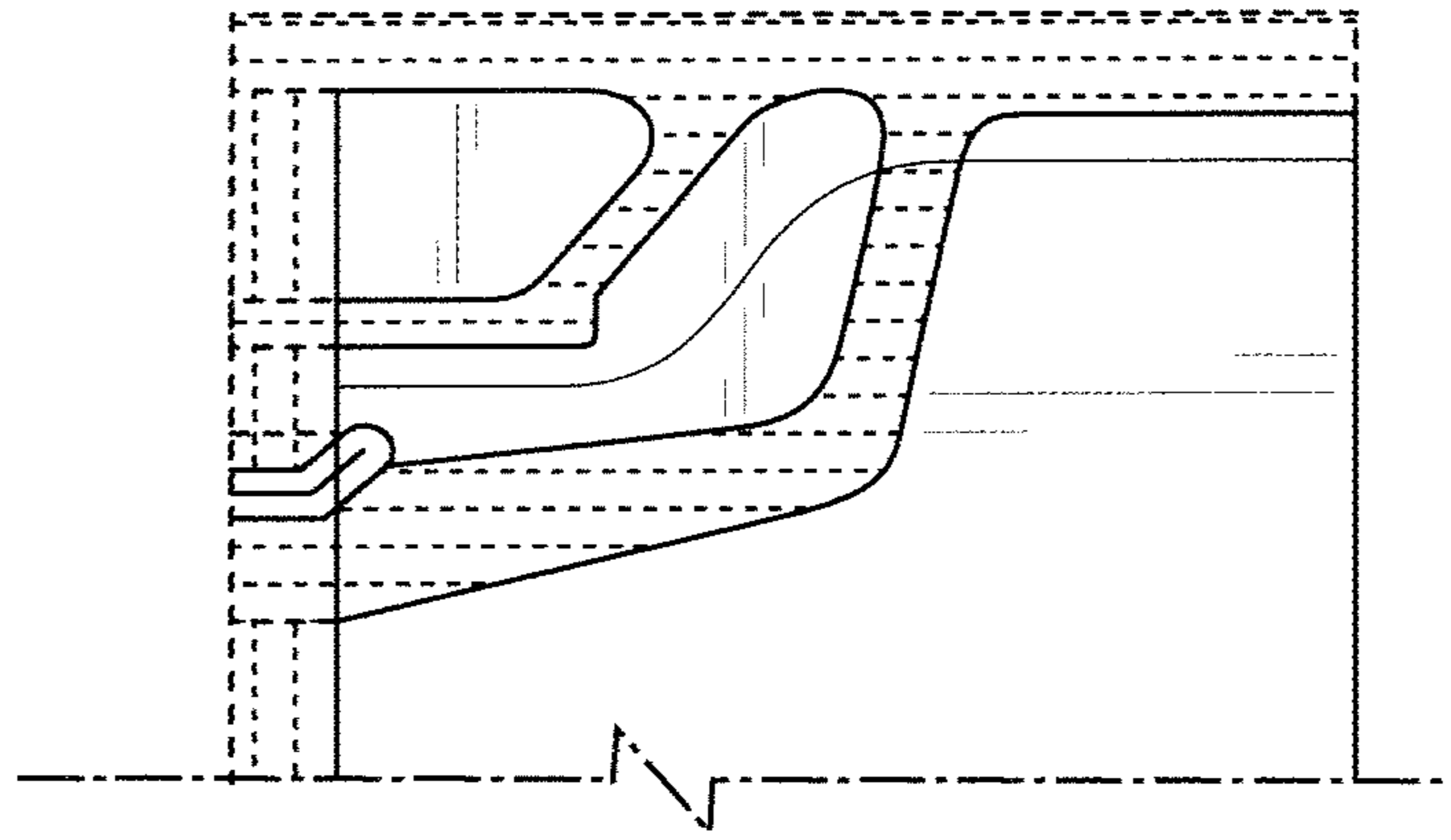

FIG. 24

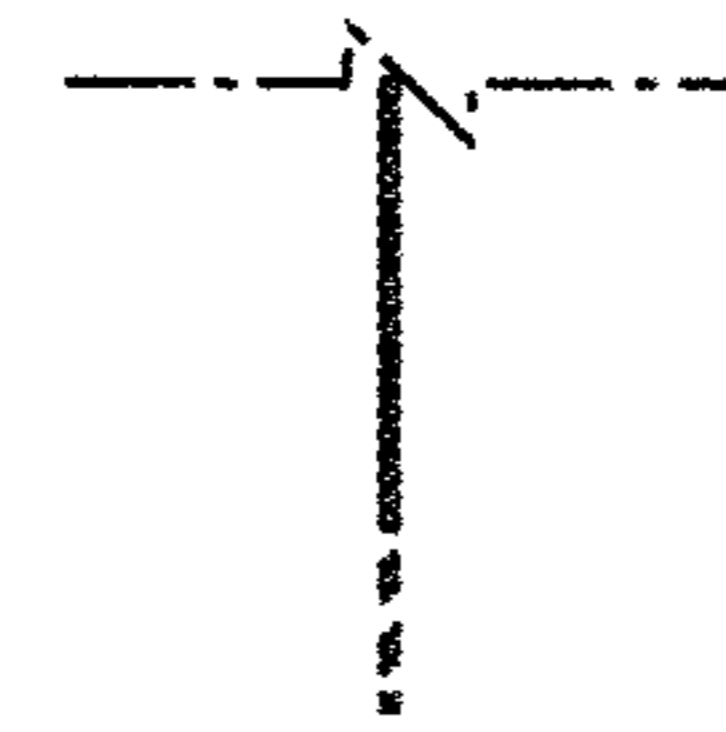
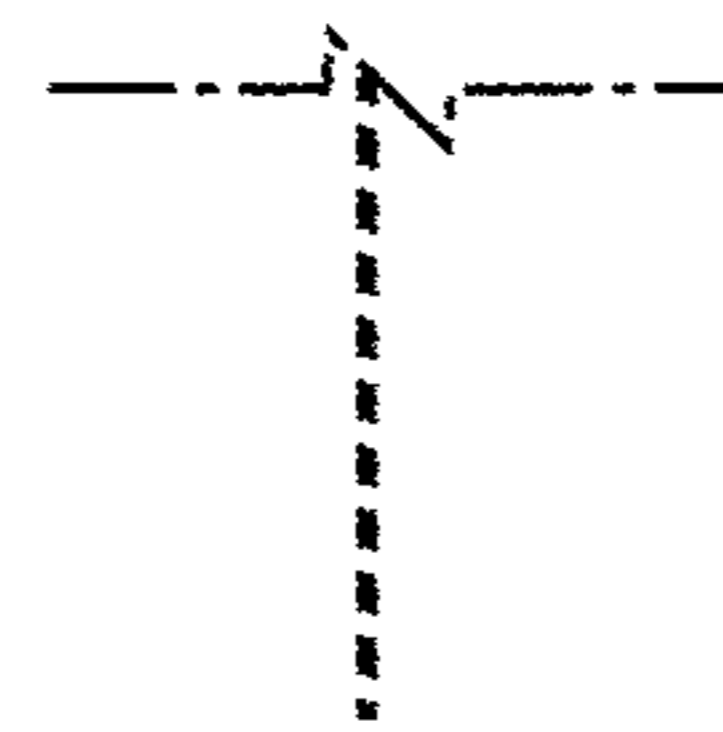
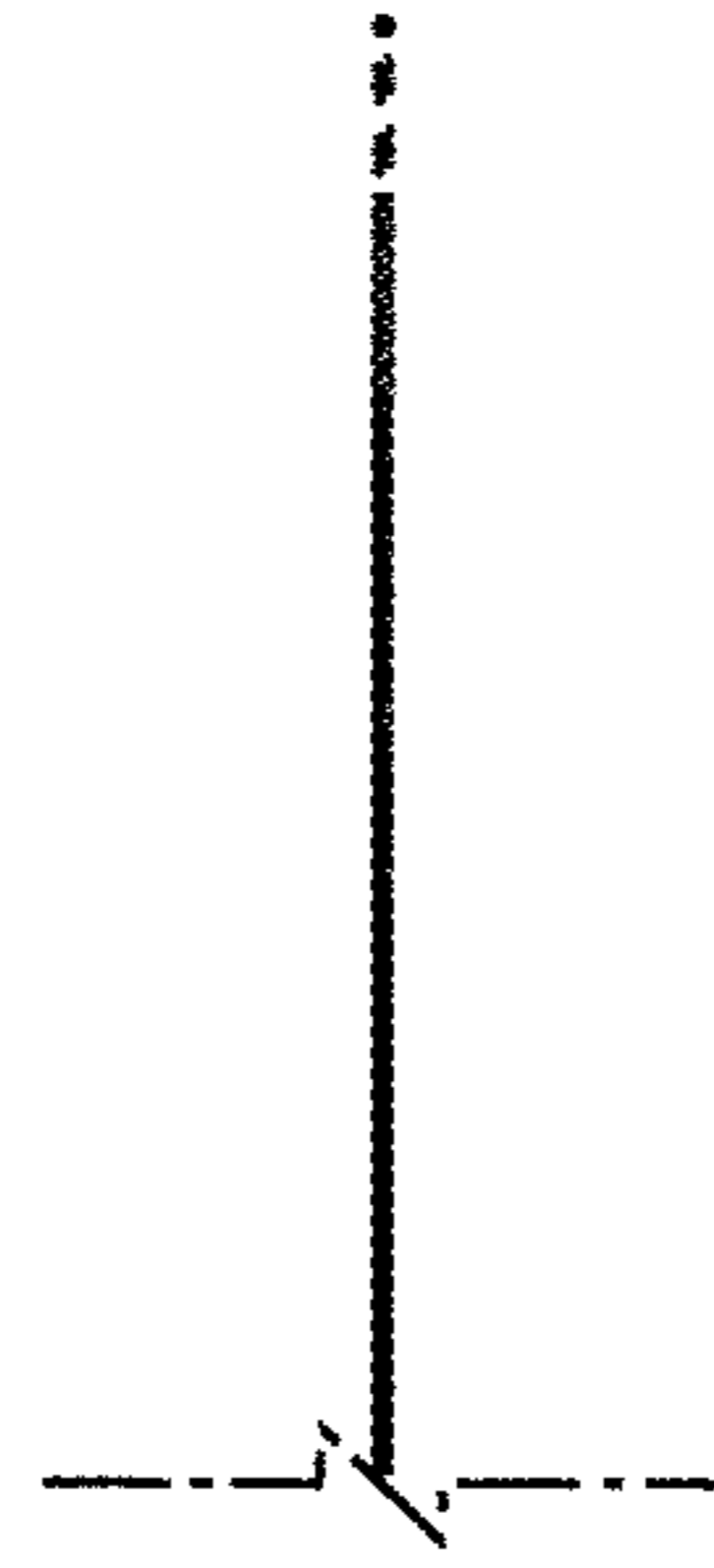
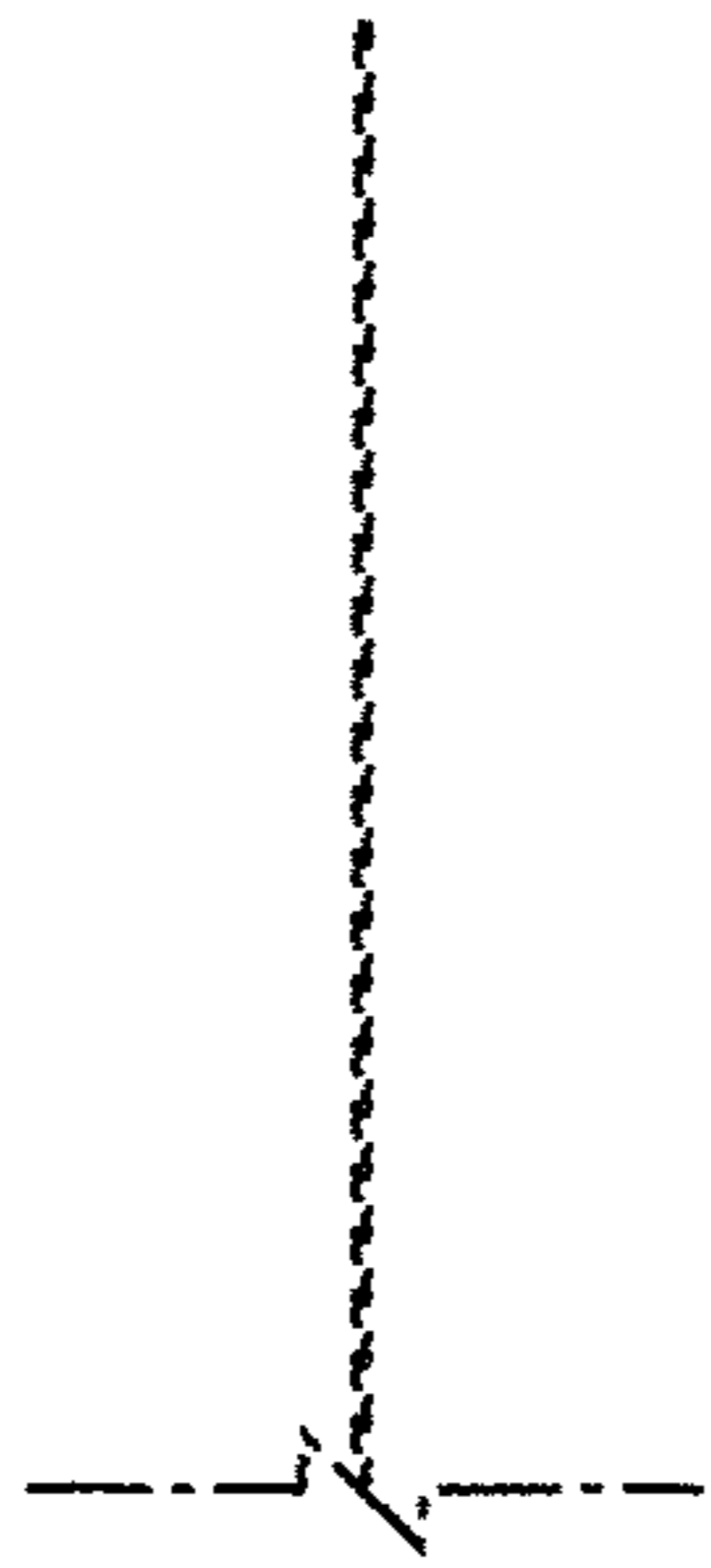

FIG. 25

FIG. 26



FIG. 27



FIG. 28