



US00D883050S

(12) **United States Design Patent** (10) **Patent No.:** **US D883,050 S**
Maez (45) **Date of Patent:** **** May 5, 2020**

(54) **DUAL TINED RAKE**
(71) Applicant: **Jason Maez**, Clovis, CA (US)
(72) Inventor: **Jason Maez**, Clovis, CA (US)
(**) Term: **15 Years**
(21) Appl. No.: **29/700,822**
(22) Filed: **Aug. 6, 2019**
(51) **LOC (12) Cl.** **08-01**
(52) **U.S. Cl.**
USPC **D8/13**
(58) **Field of Classification Search**
USPC D8/13; D30/158; D21/532
CPC ... A01D 7/10; A01D 7/00; A01D 7/02; A01D
51/00
See application file for complete search history.

6,336,314 B1 * 1/2002 Crevier A01D 7/10
294/50.8
6,381,938 B1 * 5/2002 Kelly A01D 7/02
56/400.16
D474,948 S * 5/2003 Crites 56/400.12
D509,415 S * 9/2005 Crites D8/13
6,948,302 B1 * 9/2005 Kalloo A01D 7/00
56/400.04
D517,876 S * 3/2006 DeWinter D8/13
7,134,263 B2 11/2006 Tedesco
D543,427 S * 5/2007 Willison D8/13
D554,958 S * 11/2007 Kelley D8/13
D649,846 S * 12/2011 Economou D8/13
8,776,909 B2 7/2014 Johnson
(Continued)

FOREIGN PATENT DOCUMENTS

WO WO2005082125 9/2005
Primary Examiner — Sheryl Lane

(56) **References Cited**

U.S. PATENT DOCUMENTS

1,665,183 A 4/1928 Urban
3,095,682 A * 7/1963 Pasquine A01D 7/10
56/400.12
3,332,223 A * 7/1967 Polisso A01D 7/00
56/400.17
3,601,966 A * 8/1971 Kerry A01D 7/10
56/400.12
4,037,397 A * 7/1977 Fiorentino A01D 7/10
56/400.12
D274,116 S 6/1984 Lidikay
4,478,033 A 10/1984 Konyon
4,791,780 A * 12/1988 Phillips A01D 7/00
294/52
D341,756 S * 11/1993 Bass D8/13
5,425,226 A 6/1995 Kaufman
5,626,009 A 5/1997 Bower
D391,132 S * 2/1998 Gandee D8/13
5,799,996 A 9/1998 Frederickson
D442,039 S * 5/2001 Yeh D8/13
6,272,827 B1 * 8/2001 Hsu A01D 7/10
56/400.12

(57) **CLAIM**

The ornamental design for a dual tined rake, as shown and described.

DESCRIPTION

FIG. 1 is a front view of a dual tined rake showing my new design;
FIG. 2 is a rear view of the dual tined rake;
FIG. 3 is a right side view of the dual tined rake;
FIG. 4 is a detailed right side view of the dual tined rake according to the circle 4 in FIG. 3;
FIG. 5 is a left side view of the dual tined rake;
FIG. 6 is a detailed left side view of the dual tined rake according to the circle 6 in FIG. 5;
FIG. 7 is a top view of the dual tined rake;
FIG. 8 is a bottom view of the dual tined rake; and,
FIG. 9 is a top front side perspective view of the dual tined rake.

1 Claim, 5 Drawing Sheets

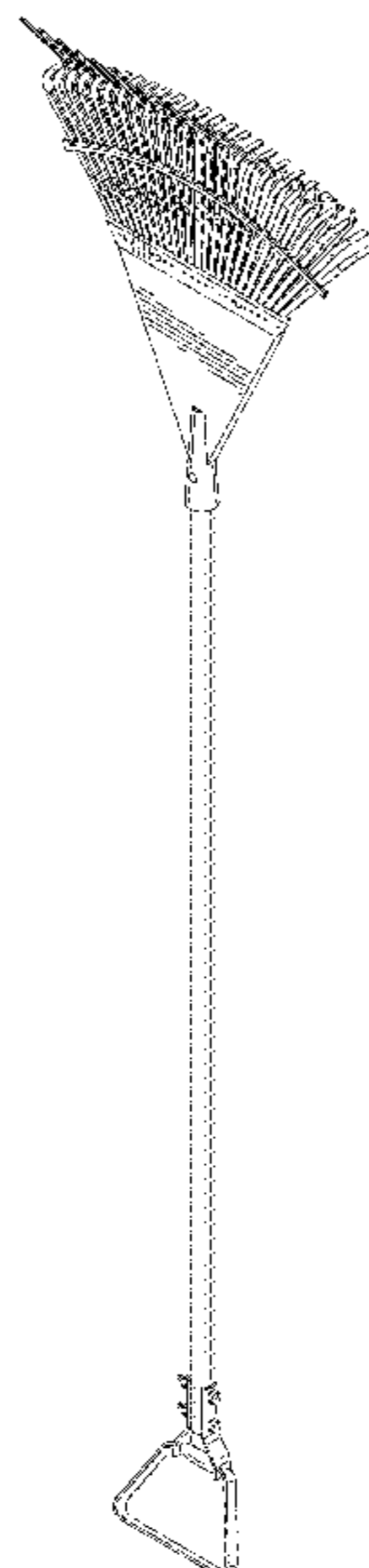

(56)

References Cited

U.S. PATENT DOCUMENTS

D769,681 S * 10/2016 Stein D8/13
D769,683 S * 10/2016 Stein D8/13
2008/0223014 A1* 9/2008 Robinson A01D 7/10
56/400.16

* cited by examiner

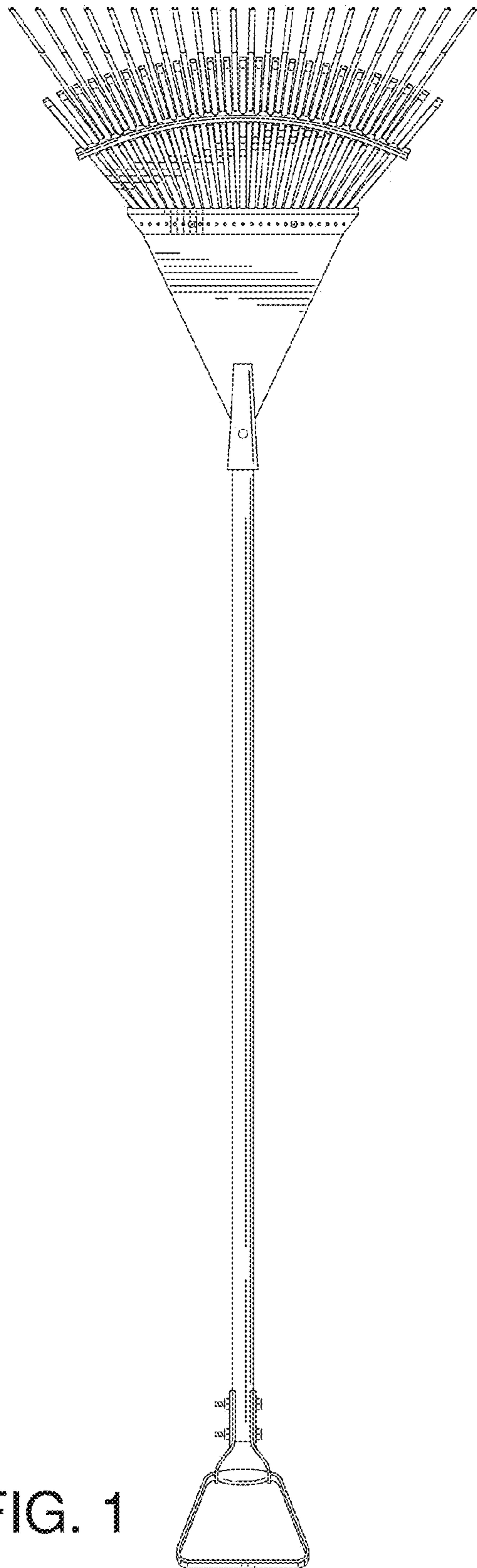

FIG. 1

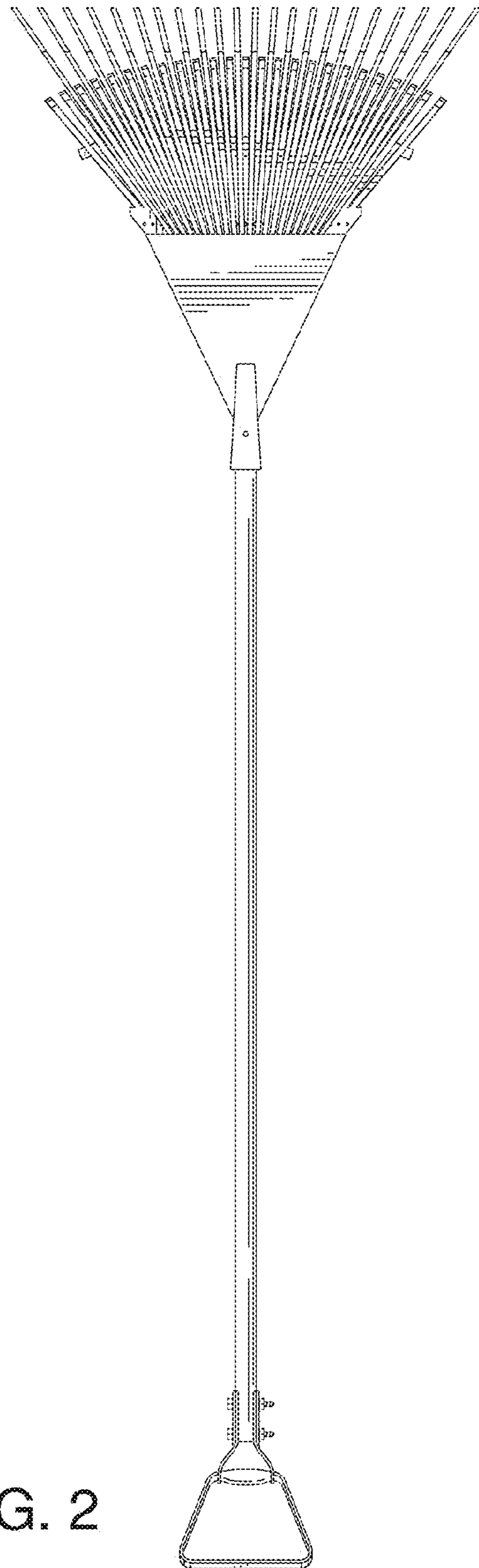
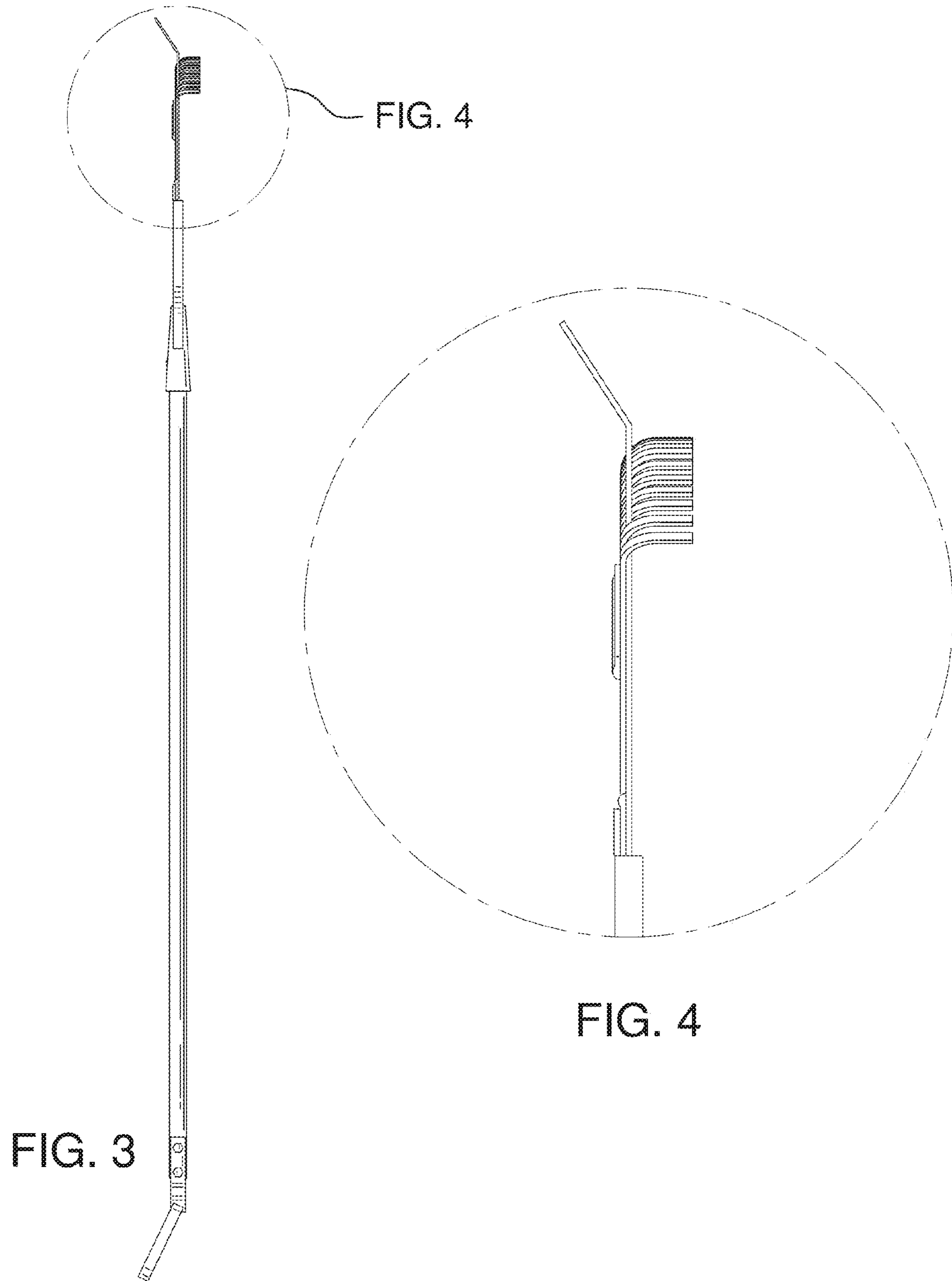
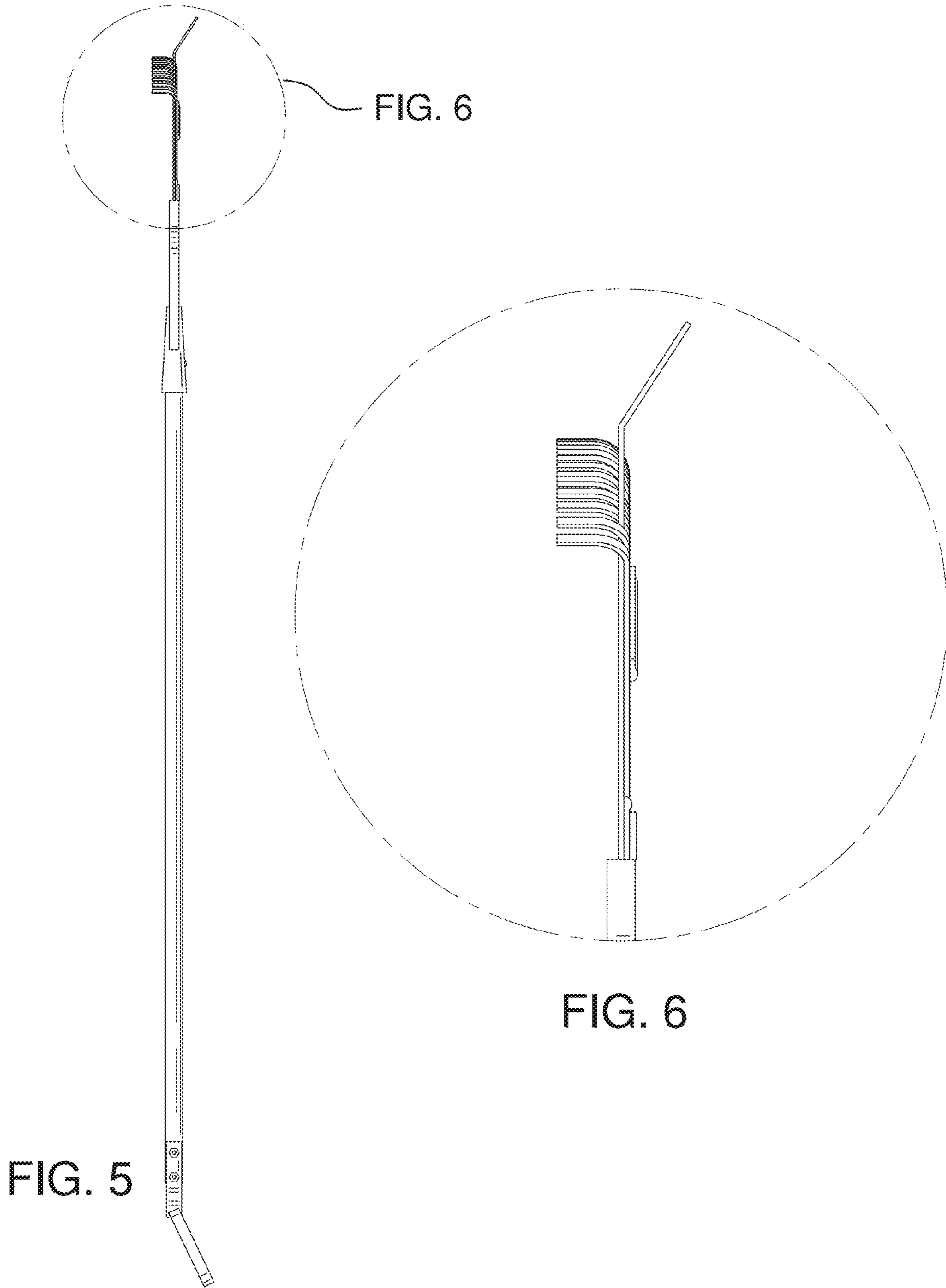

FIG. 2





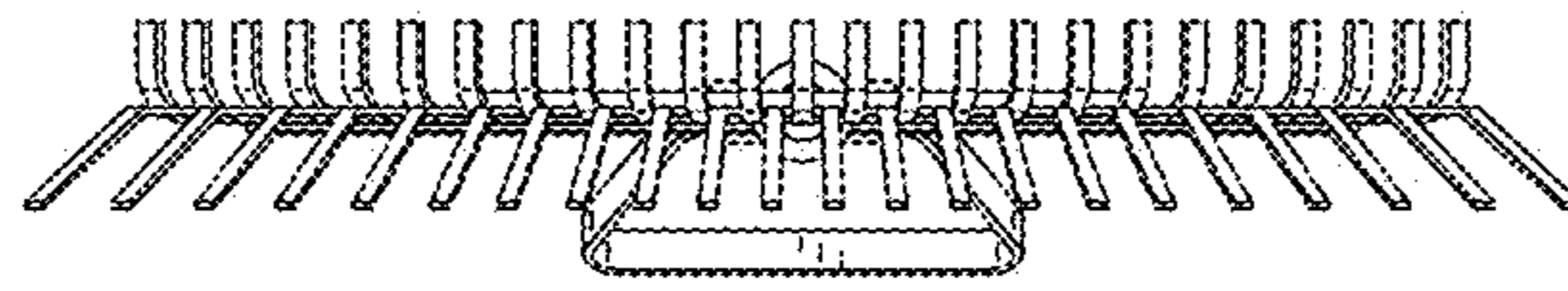

FIG. 7

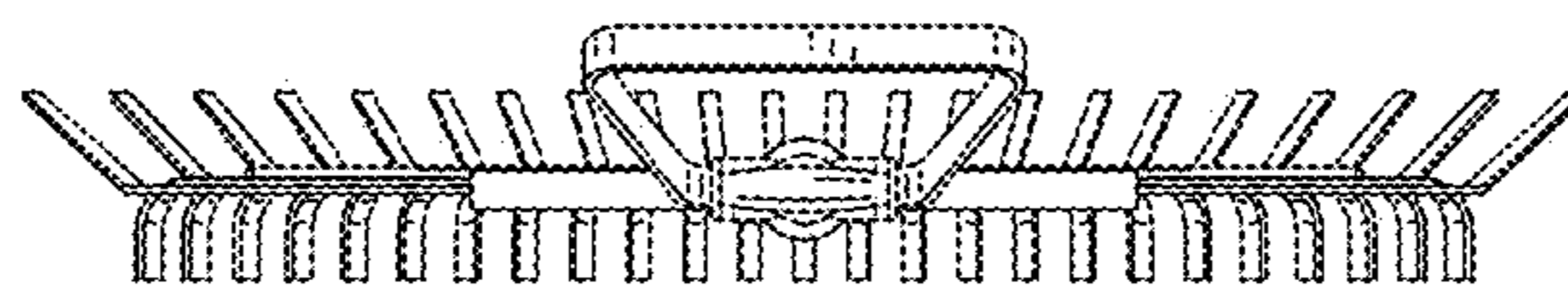

FIG. 8

FIG. 9

